

TACOMA FRONT 3-LINK SUSPENSION KIT

300757-1-KIT (1995)

300805-1-KIT (1996-2004)

300806-1-KIT (1995-2004 W/O STEERING HARDWARE AND FRAME PLATES)

KIT CONTENTS



Tacoma Front 3-Link Kit



Tacoma Front 3-Link Kit "A"

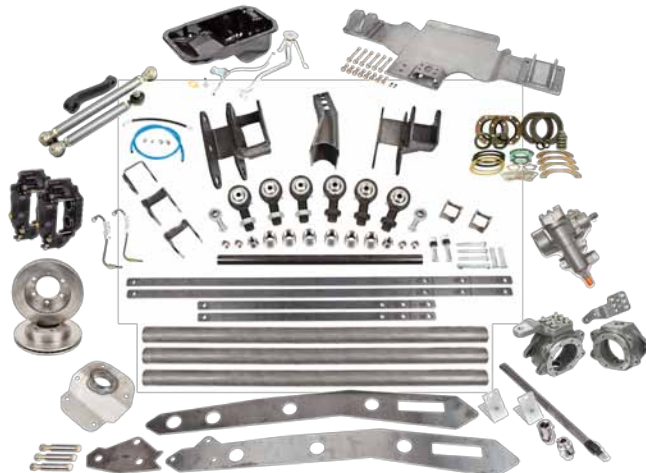

Tacoma Front 3-Link Kit "B"

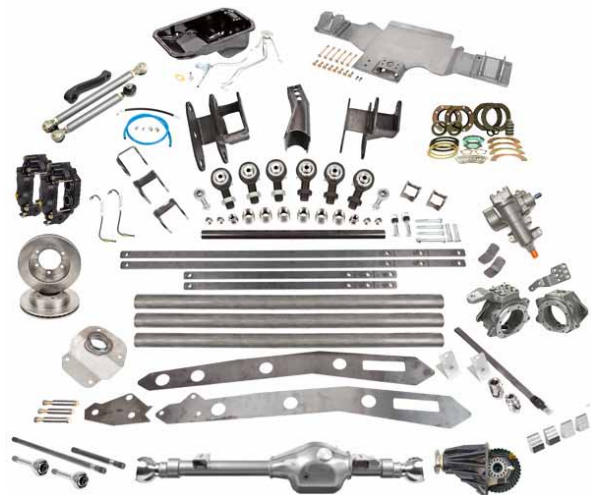

Tacoma Front 3-Link Kit "C"



RECOMMENDED TOOLS

Angle finder
Welder
Grinder
Socket set
Wrench set
Jack stands
Jack
Hammer
Tape measure

CAUTION

1. Read all instructions completely and carefully before you begin.
2. Check to make sure the kit is complete and that no parts are missing (refer to the Kit Contents List on the first page of these instructions). If anything is missing, please contact Trail-Gear at 559.252.4950.
3. Park vehicle on a clean, dry, flat, level surface and block the tires so the vehicle can not roll in either direction.
4. This build is so in depth that not every step could be covered in these instructions. If anything is not clear, please call our tech support line at 1.877.4X4.TOYS before proceeding. We have trained technicians waiting to help you.
- 5. Do not fully weld any link brackets until all clearances have been double checked.**

INSTALLATION INSTRUCTIONS



STEP 1

Measure current wheel base and take note. If your truck already has a solid axle swap kit also measure and take note of the pinion angle.



STEP 2

If your truck already has a TG SAS kit, remove leaf spring hardware and skip to step 81. If not remove front bumper, skid plate, and splash guards.



STEP 3

On vehicles with a 3.4 L V6 engine that have a radiator that hangs below the frame like shown, you will need to replace the radiator with following part numbers. (Performance Radiator #1774, Napa # APD 2740)



STEP 4

Mark the edge of the radiator for future use.

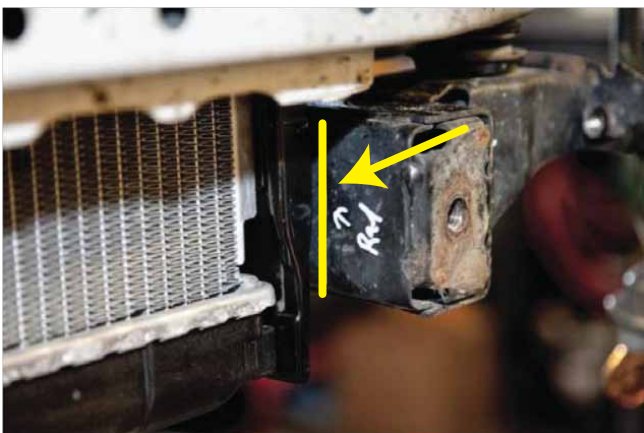

STEP 5

Remove the radiator



INSTALLATION INSTRUCTIONS



STEP 6

Unbolt and remove all IFS components.



STEP 7

Mark the body mount as close to weld as possible



STEP 8

Cut the body mount along the previously drawn line and grind the weld down. You want an approximately 1/4" gap between the frame and edge of the mounting bracket



STEP 9

Cut the inner support plate of the body mount 1/2 of the way in.

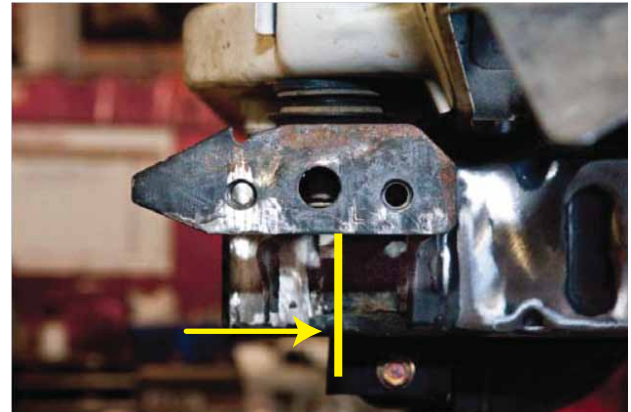

STEP 10

Slide front hanger mount onto the frame rails. Mount hanger locating jig to the body mount and slide it all the way forward.

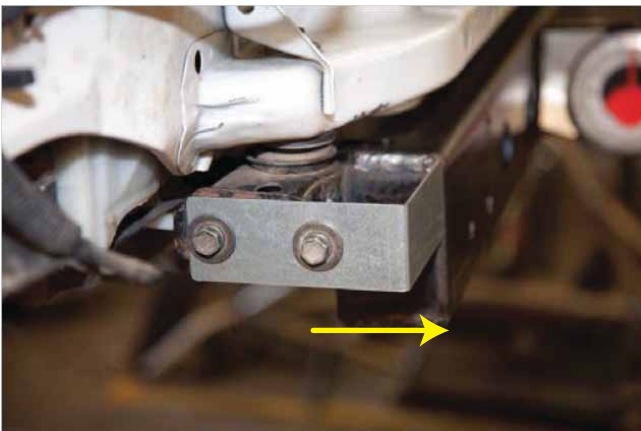

STEP 11

Use straight edge to ensure that the mount is flush with the jig.



INSTALLATION INSTRUCTIONS



STEP 12

Make sure the mount is square and straight to the truck



STEP 13

Tack the mount in place. Verify the mount is still straight and weld it completely.



STEP 14

Weld the area shown below.

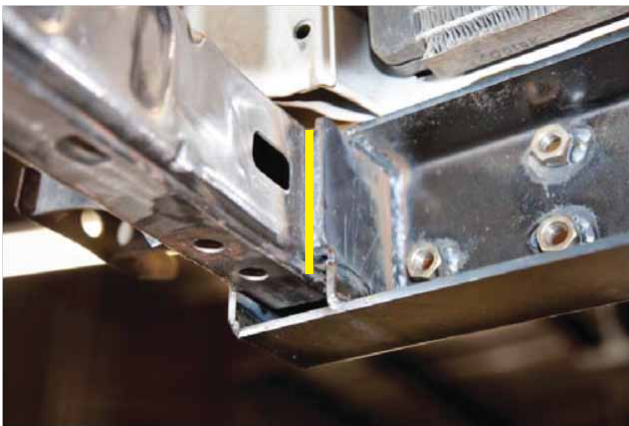

STEP 15

Weld the areas shown below.



STEP 16

Cut the brake line tab off as shown for future.

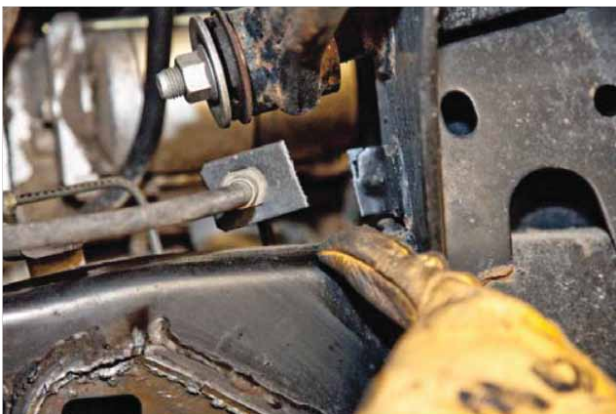

STEP 17

After all of the other brackets have been unbolted or removed, brackets 1,2,3, and 4 will need to be removed with a torch or plasma cutter.

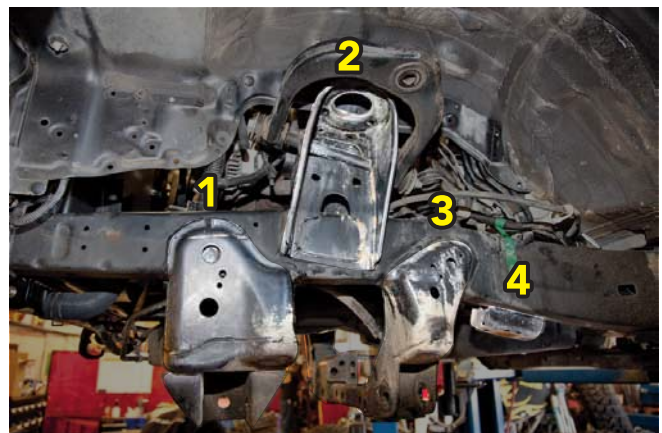

INSTALLATION INSTRUCTIONS



STEP 18

Grind the frame clean



STEP 19

If you have a 2.7L engine, start here to remove the oil pan. If you have a 3.4L engine, skip to step 36. Remove the dust shield.



STEP 20

Remove the oil pan.



STEP 21

Remove dipstick bracket hardware.



STEP 22

Remove the stock dipstick.



STEP 23

Apply Ultra Grey to bottom of freeze plug.



INSTALLATION INSTRUCTIONS



STEP 24

Place freeze plug in stock dipstick hole.



STEP 25

Lightly tap freeze plug to secure it into place.



STEP 26

Locate the small freeze plug approximately 2" behind motor mount.



STEP 27

Using a punch, remove the freeze plug.



STEP 28

Install the new dipstick tube into the block using Ultra Grey at the mating surface.

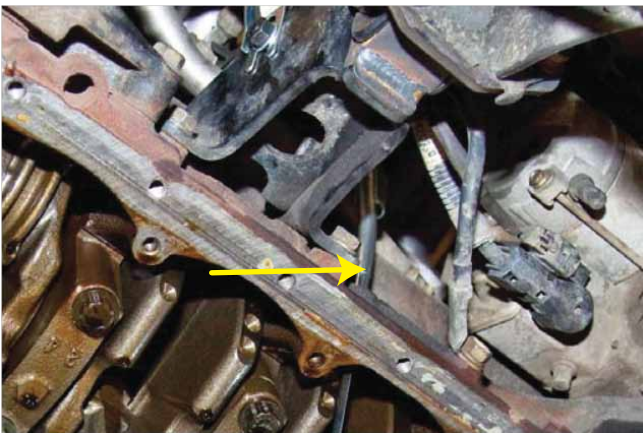

STEP 29

Mark and drill a hole in the motor mount bracket to mount dipstick tube. We drilled a 5/16" hole and used an 8mm bolt.



INSTALLATION INSTRUCTIONS



STEP 30

Fasten the dipstick tube to the motor mount.



STEP 31

Remove the stock strainer and install the new one.



STEP 32

Using a razor, clean the oil pan mating surface on the block.



STEP 33

Apply a bead of ultra grey to the oil pan mating surface.



STEP 34

Install the new oil pan. The strainer now sits towards the back of the truck.



STEP 35

Re-install the dust shield.



INSTALLATION INSTRUCTIONS



STEP 36

Install the drain plug.



STEP 37

If you have a 3.4L engine, follow these instructions to replace your oil pan. Remove dust shield.



STEP 38

Remove the oil pan.



STEP 39

Remove the stock strainer and replace it with the new one.



STEP 40

Using a razor, clean the oil pan mating surface on the block.

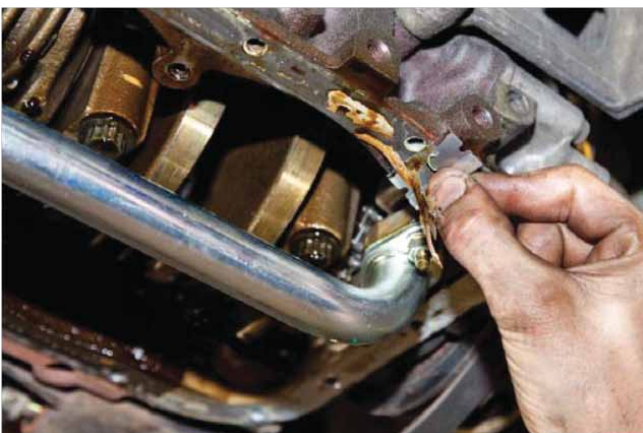

STEP 41

Mark the stock dipstick 1/8" below full line and cut off the excess. The stock full level on the dipstick will still be used and the 6 1/2 quarts of oil are used.



INSTALLATION INSTRUCTIONS



STEP 42

Re-install the dip stick into the block.

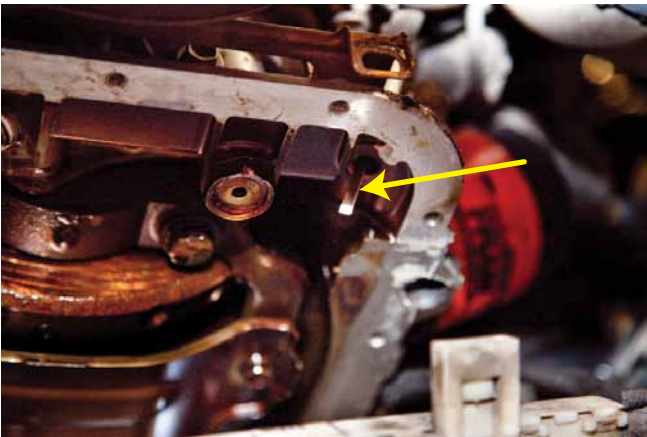

STEP 43

Apply a bead of Ultra Grey to the oil pan.



STEP 44

Install the new oil pan. The strainer now sits towards the back of the truck.



STEP 45

Re-install the dust shield. The circled bolt will need to be shortened by 3/8"



STEP 46

Install the drain plug with gasket.



STEP 47

Weld off the body mount.



INSTALLATION INSTRUCTIONS



STEP 48

Mark the inner vendor well as shown in the picture below. Be careful not to cut the pinch weld.



STEP 49

Clamp steering box in desired location. The box should be moved as far forward as possible leaving approximately a 1/4" of clearance between the core support and steering box.



STEP 50

Clamp the frame plate to the frame, centering it on the frame and aligning it with the previously marked hole.



STEP 51

Using the frame plate as a template, drill the 2 marked holes in the frame to 1/2". Be sure to drill straight through both sides of the frame.



STEP 52

On the inside of the frame only, drill holes to 3/4" to allow the sleeves to be installed in the frame.



STEP 53

Install (3) 1/2" bolts through the previously drilled holes. Install sleeves over bolts and inner frame plates as shown.



INSTALLATION INSTRUCTIONS



STEP 54

Tack weld the inner frame plate and sleeves in place.



STEP 55

Tack weld the frame plate to the frame and then weld in sections to avoid frame warping. At this time you can also weld off inner frame plate and sleeves.



STEP 56

On the passenger side, position and clamp the frame plates to the frame, aligning the rectangle hole and centering the rest of the plate on the frame.



STEP 57

You may want to plug weld the frame holes shown.



STEP 58

Tack weld the frame plate to the frame and remove the clamps.



STEP 59

We recommend welding the frame plate on the frame in steps, allowing the frame to cool to prevent warping. First, weld the inner holes.



INSTALLATION INSTRUCTIONS



STEP 60

Next, weld the front, rear and angled section.



STEP 61

After frame cools finish welding remaining portions.

STEP 62

Install IFS steering box.



STEP 63

Remove the steering shaft dust cover located behind the brake pedal.



STEP 64

Remove the steering shaft and coupler from the column.



STEP 65

Remove the seal housing from the firewall.



INSTALLATION INSTRUCTIONS



STEP 66

Remove the seal from the seal housing.



STEP 67

Install the factory seal from your seal housing into the supplied seal housing. Paint as desired.



STEP 68

Install the seal housing into the firewall.



STEP 69

Install supplied steering box coupler to the supplied steering shaft. Tighten long set screw to make mark on shaft. Remove the coupler.



STEP 70

Using the previously made mark, drill one side of the shaft out to 3/8"



STEP 71

Once the hole is drilled, install the coupler using red locktite on the set screws.



INSTALLATION INSTRUCTIONS



STEP 72

Loosen the set screw to allow for adjustment.



STEP 73

Slide the steering shaft through the seal housing and install in to the new coupler and column as shown. Make sure to use red loctite on all screws. Note: 95.5 Tacoma steering shafts are a different spline and size than 96-04. Because of this, when installing the steering joint in a 95.5 you will get a 9/16" x 3/4" double-d steering joint. The 9/16" end will have no splines; this is the side of the steering joint that you will put over the spline section of your steering rod.

Use set screw to make the same type of mark you did on the first end, then drill out the hole. Install the joint and tighten the set screw, we recommend putting a small tack weld on each side of the joint as a safety precaution.

STEP 74

Install coupler on steering box using red loctite on set screw.



STEP 75

On 3.4L engines; Remove the half moon piece from your original fan shroud and reuse it on the new fan shroud.



STEP 76

The lower fan shroud tab on the driver's side might need to be trimmed to clear the steering box



STEP 77

A self tapping screw may also be required to secure the fan shroud to the radiator. Be careful not to drill through the radiator.



INSTALLATION INSTRUCTIONS



STEP 78

Slight notching of the fan shroud may be necessary to clear the steering box mount.



STEP 80

It is important to note that any items installed after this point should only be tacked on as they may need to be repositioned for clearance issues. Finish welding should only be done after all clearances have been double checked.

STEP 79

The new radiator should be approximately 2" shorter than the original radiator.

STEP 81

Place axle on bench or jack stands and raise the pinion until the pinion angle matches the angle from step one or approximately 5 degrees above the horizontal if the truck has not yet had a solid axle swap.

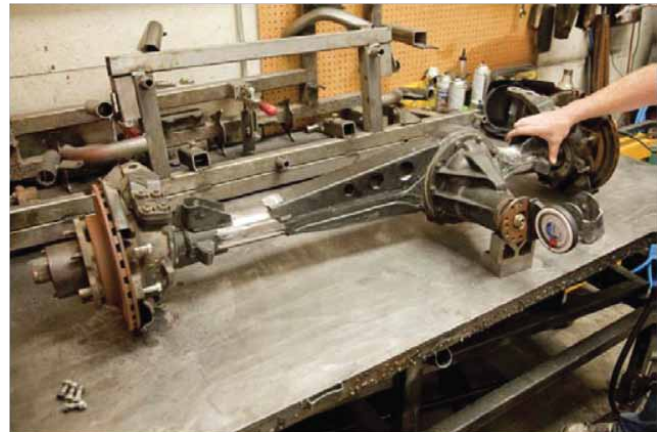

STEP 82

Place the panhard axle bracket on the long side of the axle approximately 2-1/8" away from the knuckle ball offset adapter. The front of the bracket should be perpendicular to level. And tack in place. With Tie rod and drag link in place turn steering lock to lock to ensure that the tie rod will not contact the panhard mount.



INSTALLATION INSTRUCTIONS



STEP 82 CONTINUED



STEP 83

We trimmed the passenger side lower link mount as shown to fit over the panhard mount.



STEP 84

Place the passenger lower link mount approximately $\frac{1}{2}$ " away from the knuckle offset adapter and level with the ground. Tack into place.



STEP 85

Driver side lower link mount will need to have the upper portion of the radius removed as shown in the picture to fit around the short side truss.



STEP 86

Place the driver side lower link mount approximately $\frac{1}{2}$ " away from the knuckle offset adapter and level with the ground.



INSTALLATION INSTRUCTIONS



STEP 86 CONTINUED



STEP 87

The upper link should be centered over the diff stud as shown. And slid back on the center section until the center of the bolt hole is flush with the faceplate as shown. Tack into place. Tack gussets into place depending on axle breather application one or two gussets may be used.



STEP 87 CONTINUED



STEP 88

Install frame side link brackets on frame, the passenger side is the single lower link mount while the driver side mounts both the upper and lower link. On test builds the center of the link mount hole was approximately 19 1/2" inches from the body mount measured as shown. Tack into place. A c-clamp may be used to hold the brackets onto the frame for welding.

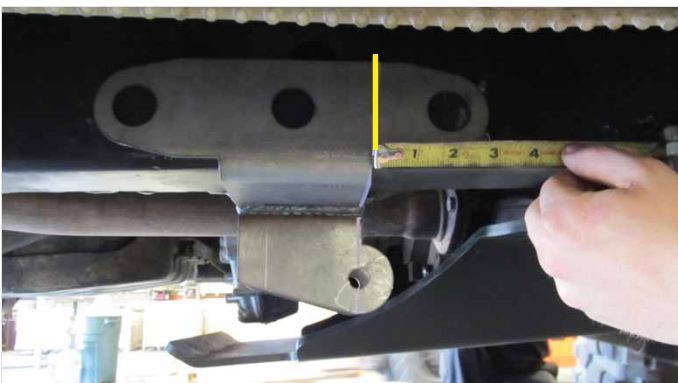

INSTALLATION INSTRUCTIONS



STEP 89

If axle does not currently have shock mounts install them now.

STEP 90

With the truck at desired ride height place axle under the truck at the desired wheel base, and roughly center the axle side to side under the truck. Install frame side panhard as shown. When installed panhard bar should be perpendicular to the frame at ride height.



STEP 91

Measure for link lengths, by measuring from eye to eye between the axle side and frame side brackets and record in table below



STEP 92

To determine cut lengths for links start off by installing a creeper joint into a bung with a few threads showing to leave room for adjustability, the exact amount depends on the end user. Then measure from the center of the bolt hole to where the end of the tubing would sit on the bung. Take this measurement and multiply by two to account for both creeper joints on one link. Use the following table to keep track of the measurements. Measurement #4 in the table below will be the cut length for your links. The cut lengths for our build happened to be 35 1/2" for the lowers and 37 5/8" for the upper, but may vary from truck to truck.



Lower Links	
	Measurement
1. Axle bracket to frame bracket	
2. Center of creeper joint to tube stop on bung	
3. Double measurement #2	
4. Subtract measurement #3 from #1	
Upper Link	
	Measurement
1. Axle bracket to frame bracket	
2. Center of creeper joint to tube stop on bung	
3. Double measurement #2	
4. Subtract measurement #3 from #1	

INSTALLATION INSTRUCTIONS



STEP 93

Install upper link, lower links, panhard link, link bolts, tie rod and drag link.

STEP 94

Cut shock "mock-up" strips to proper application length for the shock that you will use. We recommend 14" shocks for this kit. Note: These shock strips will only work with Fox 2.0 air shocks.

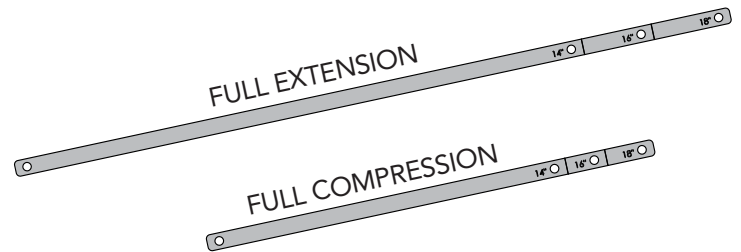

STEP 95

Once all links and panhard have been installed raise the vehicle/lower the axle to maximum droop. The cross-member may need to be clearanced on the driver side for the upper link in some cases. Full extension will be when the u joint starts to bind or slightly before the tie rod end of the drag link runs out of travel. Using the full extension shock strip as a guide you may now fabricate upper shock mounts. It is important to ensure that the tie rod will drop below the steering arm at full extension to prevent damage to the tie rod end which could result in loss of steering as shown below.



STEP 96

Once full extension is determined and suitable shock mounts are made move the axle to full compression and install the short shock strips. Check for any metal to metal contact such as the panhard link contacting the oil pan or the panhard mount contacting the frame, to prevent this it may be necessary to limit the up travel of the suspension by installing bump stops. It is also important to check that the tie rod does not contact the drag link.



STEP 97

Using shock strips check all clearances to check for any binding or metal to metal contact. Full extension, full compression, full flex left, full flex right.



STEP 98

Install tire and shocks, but do not pressurize to check clearances. Again check full extension, full compression, full flex left, full flex right.

STEP 99

When all clearances are verified remove shocks and links. Fully weld all brackets and paint as desired. Reinstall shocks, links, steering and necessary hardware.

STEP 100

Pressurize shocks to set desired ride height. Test drive and recheck all hardware.

INSTALLATION INSTRUCTIONS



SERVICE PARTS:

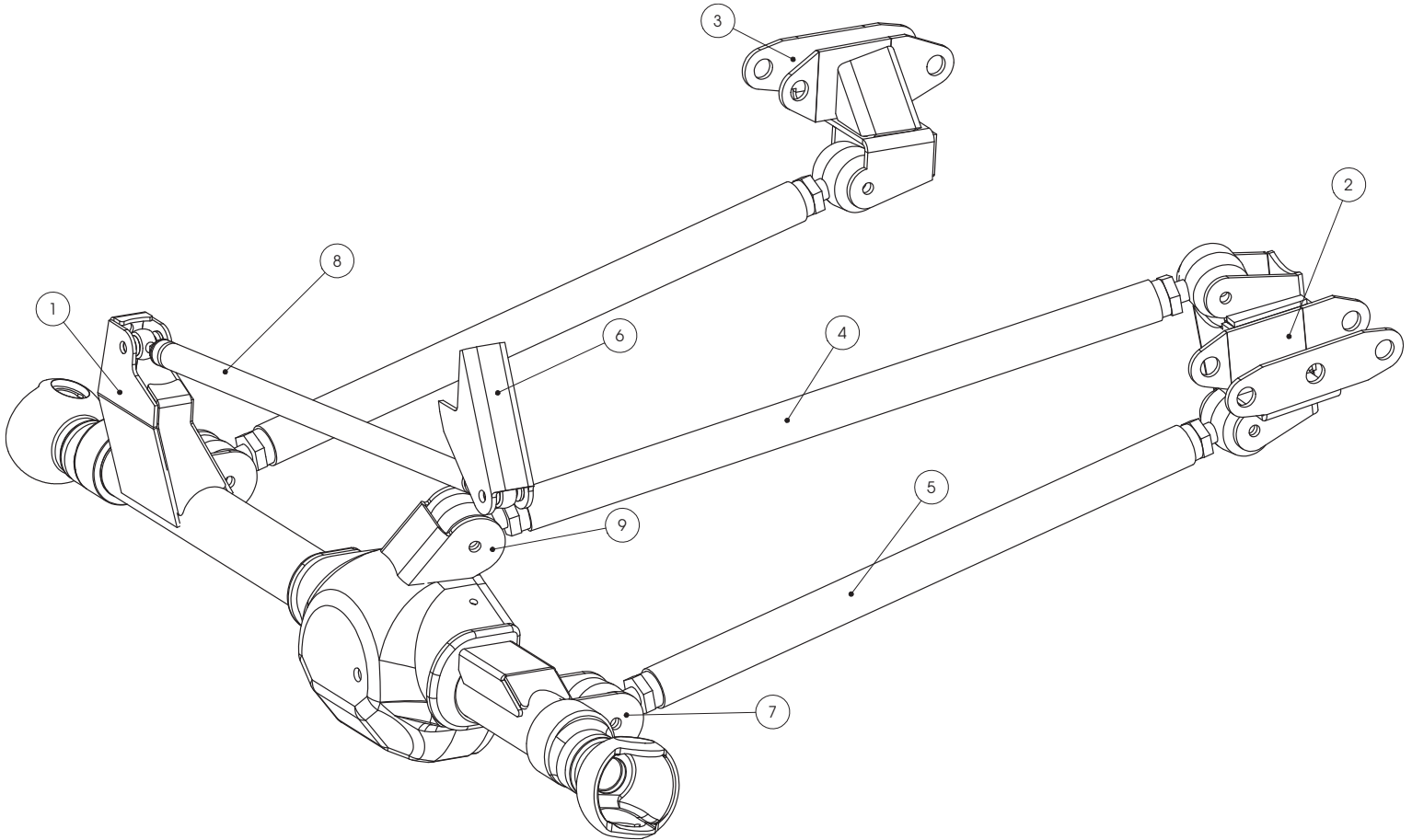

ITEM NO.	PART NUMBER	DESCRIPTION	QTY
1	300650-1	TACOMA FRONT 3 AXLE SIDE PANHRD	1
2	300644-1	TACOMA FRONT 3 DRIVER LINK MOUNT	1
3	300661-1	TACOMA FRONT 3 PASSENGER LINK MOUNT	1
4	110126-1	LINK TUBING 40 INCH	1
5	110182-1	LINK TUBING 36 INCH	2
6	300271-1-KIT	FRONT 3 HIGHSTEER FRAME SIDE PANHARD	1
7	110077-1-KIT	LOWER LINK MOUNT	2
8	300797-1	PANHARD BAR FRONT 3 TACOMA	1
9	110144-1	UPPER LINK MOUNT	1