

Installation Instructions for 555-79006

4 Ton Bottle Jack

CAUTION: Before using this product, read this manual and follow all Safety Rules and Operational Instructions.

SPECIFICATIONS	Capacity	Lift Range
	4 Ton (8000 lbs.)	8.15"-13.58"
		8.15"-16.02" with screw extension

Owner and/or Operator Responsibility

The owner and/or operator shall read, study and understand the product instructions and retain them for future reference.

Operation

The owner and/or operator shall have an understanding of the product and safety operating instructions before operating the product. Safety information shall be emphasized and understood. If the operator is not fluent in English, the product warnings/cautions and instructions shall be read to and discussed with the operator in operator's native language by purchaser/owner or his designee, insuring that the operator comprehends their content.

Inspection

- (a) Visual inspection **MUST** be made prior to each use of the jack. Check for cracks, cracked welds, missing or damaged parts.
- (b) Keep all moving parts clean and well lubricated.
- (c) Owners and/or operators should be aware that repair of this equipment may require specialized knowledge and facilities. It is recommended that an annual inspection of the product be made by a manufacturer or supplier's authorized repair facility and that any defective parts, decals, or safety labels and signs be replaced with manufacturer or supplier's specified parts.

Damaged Equipment

Any jack that appears to be damaged in any way or is found to be worn or operates abnormally **SHALL BE REMOVED FROM SERVICE IMMEDIATELY UNTIL REPAIRED**. It is recommended that a manufacturer or supplier's authorized repair facility make necessary repairs if the manufacturer or supplier permits repairs

Alterations

Because of potential hazards associated with the misuse of equipment of this type, **NO MODIFICATIONS/ALTERATIONS** shall be made to the product.

Attachments and Adaptors

Only attachments and/or adaptors supplied by the manufacturer shall be used.



1-800-345-4545 jeps.com

WARNING!!

- Read, study and understand all instructions before operating this device.
- Do not exceed rated capacity. Over-loading may cause damage to/or failure of the jack.
- Always use only on hard, level surface. Do not use equipment on slopes or angles.
- Lifting device only. Jack must not be used as a jack stand to hold loads for prolonged periods of time.
- Immediately after lifting, support the vehicle with appropriate means. Use jack stands in pairs to support loads.
- Inspect jack stands before use as indicated by the manufacturer's owner's manual.
- Lift only on areas of the vehicle as specified by the vehicle manufacturer's owner's manual.
- Center load on the jack saddle. Off center loads can cause loss of load or damages to load and/or equipment.
- Never work directly under a supported load.
- Do not move or dolly the vehicle while on the jack.
- Place wheel chocks under vehicle wheels on both sides to prevent rolling.
- Use in dry, well-lit areas.
- Keep children and bystanders away. Children must never be allowed in work area. Do not let children play on or around jack or lifted load.
- Any jack that appears to be damaged in any way or is found to be worn or operates abnormally **SHALL BE REMOVED FROM SERVICE IMMEDIATELY UNTIL REPAIRED**. It is recommended that a manufacturer or supplier's authorized repair facility make necessary repairs if the manufacturer or supplier permits repairs.
- Because of potential hazards associated with this type of equipment, **NO ALTERATIONS SHALL BE MADE** to this product.
- Only attachments and/or adapters supplied by the manufacturer shall be used.
- Failure to heed these warnings may result in property damage, personal injury and/or death.



1-800-345-4545 jeps.com

Parts List

Part #	Description	Part #	Description
1	Base	16	Cap Washer
2	Ball 1/4"	17	Seal
3	Seal	18	Check Valve Kit
4	Release Valve	19	Handle
5	Packing	20	Pin
6	Cylinder	21	Pin
7	Washer	22	Cotter Pin
8	O-Ring	23	Handle Sleeve
9	Cup Seal	24	O-Ring
10	Ram	25	Top Nut
11	Extension Screw	26	Packing
12	Pump Plunger	27	Reservoir
13	Cup Seal	28	Filler Plug
14	O-Ring	29	Packing
15	Pump Cylinder		

Parts Diagram

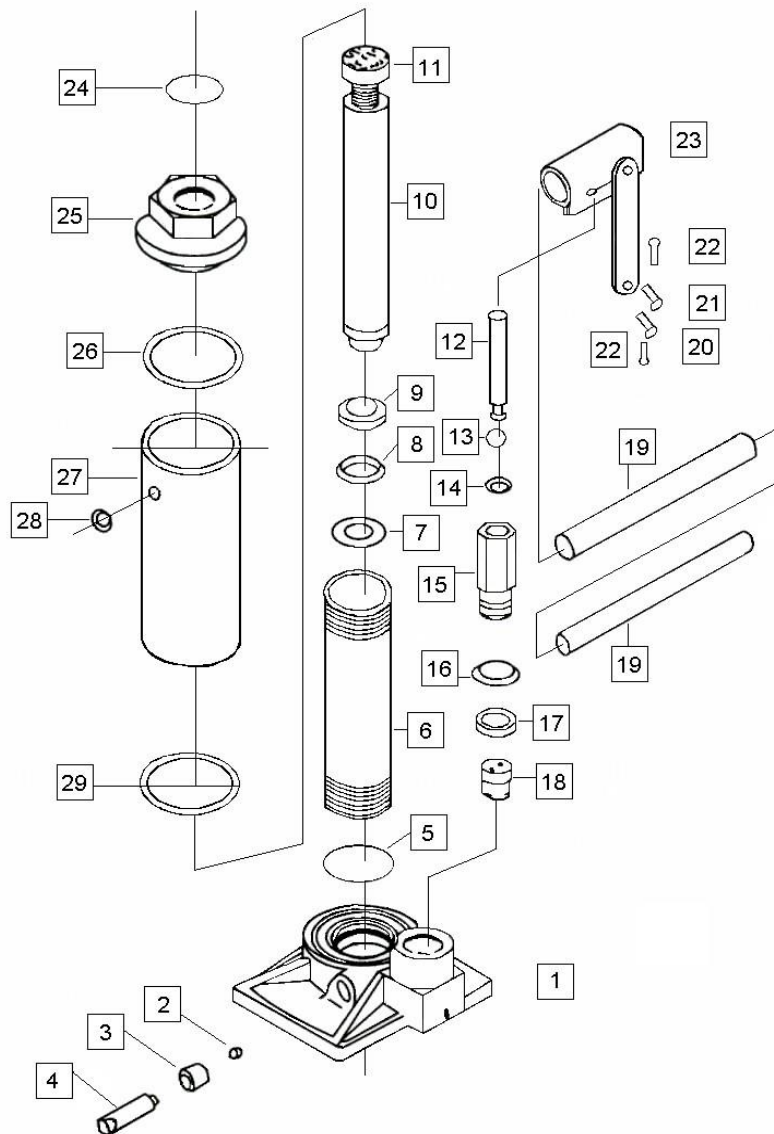

Operation

Prior to each use, visually inspect jack. Check for cracks, cracked welds, and missing and/or damaged parts. Any jack that appears to be damaged in any of these ways must not be used.

To Lift

Close release valve tightly by turning clockwise. Adjust screw extension to desired height. Pump handle up and down until vehicle is lifted.

Using the crimped end of jack handle, tighten the valve screw (A) located at the base of jack, by turning it clockwise.

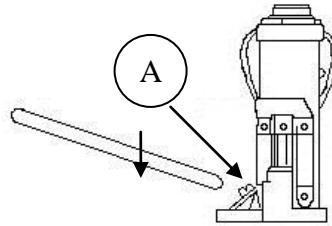

Assemble jack handle (B) and insert into housing (C). Pump handle up and down to raise jack to desired height.

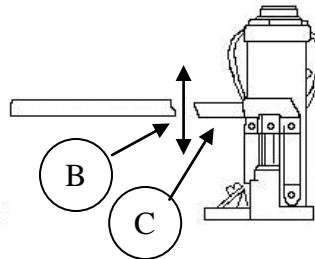

For added height: Before raising jack turn extension screw head (D) counter clockwise to desired position.

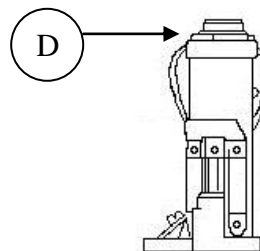

To Lower: Open the release valve very slowly by turning counter-clockwise. Turn valve screw (A), $\frac{1}{4}$ to $\frac{1}{2}$ a turn counter-clockwise Jack will slowly lower itself. Re-tighten (A) to stop jack at any desired height.

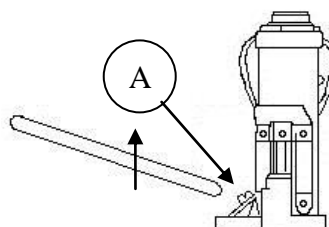

Maintenance

- (a) Visual inspection **MUST** be made prior to each use of jack. Check for cracks, cracked welds, missing or damaged parts.
- (b) Keep all moving parts clean and well lubricated.
- (c) Owners and/or operators should be aware that repair of this equipment may require specialized knowledge and facilities. It is recommended that an annual inspection of the product be made by a manufacturer or supplier's authorized repair facility and that any defective parts, decals, or safety labels and signs be replaced with manufacturer or supplier's specified parts.

Troubleshooting

Problem	Possible Cause	Remedy
Saddle won't rise	<ul style="list-style-type: none">1. Release valve open.2. Oil Exhausted.3. Defective suction and/or exhaust valve.4. Packing worn out or defective.	<ul style="list-style-type: none">1. Tighten release valve.2. Fill tank with oil.3. Check for dust or foreign matter inside and clean.4. Replace packing.
Lifts only half way	<ul style="list-style-type: none">1. Insufficient oil.	<ul style="list-style-type: none">1. Check oil supply and fill.
Lifts, then lowers out of control	<ul style="list-style-type: none">1. Air in system.2. Defective suction and/or release valve.3. Defective piston packing.	<ul style="list-style-type: none">1. Open oil plug on the front of cylinder. Hold saddle down. Open release valve and pump handle several times.2. Clean valves and adjust valve contact.3. Replace the piston packing.
Erratic lift.	<ul style="list-style-type: none">1. Defective plunger packing and/or valve.	<ul style="list-style-type: none">1. Clean valves and/or packing.



1-800-345-4545 jeps.com