



## 38 Series Installation

Auto racing remains a very dangerous sport regardless of any protective devices you may use. Please read the instructions very carefully and if you

have any questions please contact Kirkey Racing Fabrication Inc. 1-800-363-4885.

**FAILURE TO COMPLY WITH THESE INSTRUCTIONS MAY CAUSE SERIOUS INJURY OR DEATH.**

### **SEAT ASSEMBLY**

Using the bolt kit supplied install right and left rib braces. (See image #1)

### **MOUNTING INSTRUCTIONS**

This seat is to be mounted using the following instructions.

For the bottom of the seat, we recommend that you use Kirkey lower side mounts (part# 99214, see image #2).

If mounting seat direct to roll cage use no less than four (4) 5/16" (8mm) bolts directly through the bottom of seat to the frame or roll cage. (Spread bolts out as far as possible to distribute the load). NEVER mount to sheet metal.

For the back of the seat, we recommend using Kirkey rear seat mount (part# 99212, see image #3).

If mounting seat direct to roll cage use no less than two (2) 5/16" (8mm) bolts through the back of the seat (below the shoulder belt openings) to the roll cage. NEVER mount to sheet metal.

**If you are not qualified to perform such fabrication have the installation done by an expert familiar with the requirements of such installation.**

**We DO NOT recommend the use of stock sliders and adjusters.**

Be sure to check with your sanctioning body and/or track for their rules and regulations on seat mounting. Not intended for highway or airplane use.

Image #1



Image #2

Kirkey Racing Fabrication  
Part # 99214  
Weight: 1.95 lbs (pair)

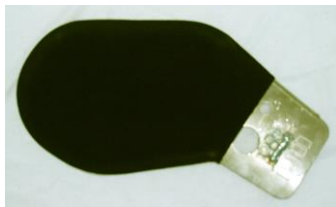
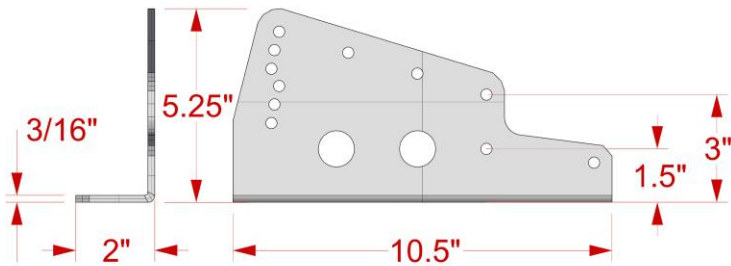

Part # 02100 Right Side Leg Restraint  
Part # 02111 Black Tweed Cover for 02100

Image #3

Kirkey Racing Fabrication  
Part # 99212  
Weight: 1.40 lbs

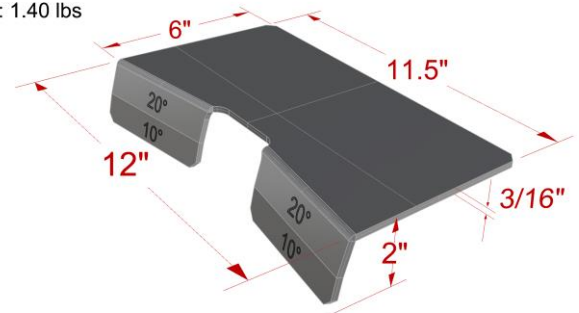

Part # 02200 Left Side Leg Restraint  
Part # 02211 Black Tweed Cover for 02200

For more information please contact us  
[www.kirkeyracing.com](http://www.kirkeyracing.com)      [kirkey@kirkeyracing.com](mailto:kirkey@kirkeyracing.com)  
1-800-363-4885 (voice)      1-800-829-7072 (fax)

# SEATBELT INSTALLATION GUIDE\* FOR UPRIGHT SEATING (UP TO 25° RECLINE SEAT BACK ANGLE)

June 5, 2012

**\*IMPORTANT NOTICE:** The purpose of this guide is to provide motorsports vehicle drivers, owners and mechanics with additional information on seatbelt installation. This guide is for informational purposes only and in no way should it be construed to be an express or implied warranty of safety or guarantee that Driver Restraint Systems mounted in accordance with this guide will prevent any injury, systems failure, property damage, or death. Participation in motorsports carries with it the risk of serious injury, property damage and death at all times regardless of which driver restraint systems are used. This informational guide does not supersede or replace product manufacturers' installation instructions or sanctioning body rules and requirements. This guide applies to Driver Restraint Assemblies which pertain to the SFI Specification 16.1 and SFI Specification 16.5 compliance programs. Prior to any seatbelt installation or installation modification, consult with the motorsports vehicle builder, seatbelt manufacturer, and sanctioning body. At all times the driver and vehicle owner have prime responsibility for the safe installation and use of seatbelts.

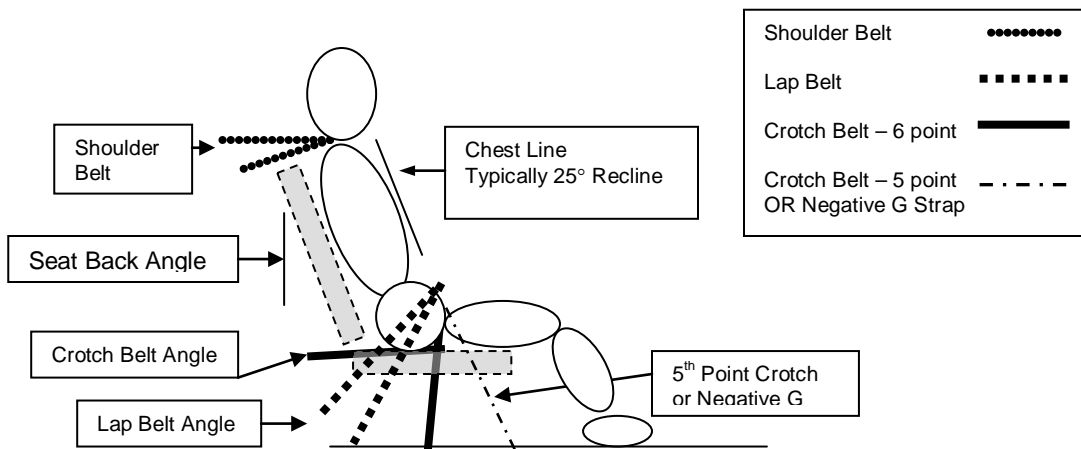

## SHOULDER BELTS

Shoulder Belt Angle: 0 to -20° (-10° optimum) from horizontal

- Clear passage of webbing from top of shoulder (or head and neck restraint) back to the harness bar or mounting point without any interference of the seat openings
- Belts should be as short as possible back to the mounting points

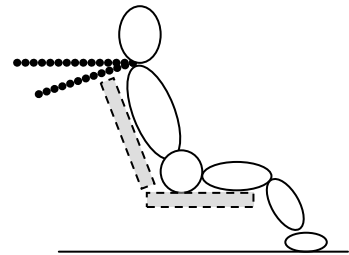

Double Shoulder Belt (Over/Under Belt):

- Upper belt (2" belt) 0 to -10° (-10° optimum)
- Body belt (3" belt) -10 to -30° (-20° optimum)
- Separation between upper and lower belt 1" to 2"
- Upper belt mounted to line up with the inside edge (closer to the neck) of the Body belt

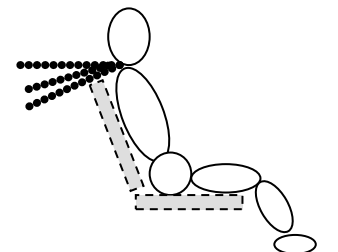

Proper Wrap of Shoulder Belt:

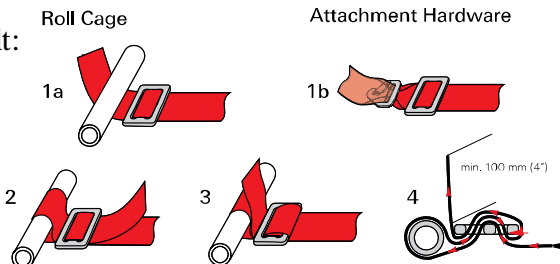

## LAP BELTS

Lap Belt Angle: -45° to -80° from the horizontal

- Belt should ride within the curvature of the pelvic bone preferably just below the iliac crest
- There should be clear passage through the seat opening without webbing being corded or binding on edges of seat openings with a direct path to the mounting point
- The webbing should not ride against any hardware such as seat mounting brackets, bolts, or tabs
- Lap belt adjusters should be clear of the seat openings. Pull-up adjusters if outside the seat opening should be a minimum of 2" below the opening when the lap belt is tightened
- Belts to the mounting point should be as short as possible mounted beside the seat and never behind the seat
- Lap belt should be allowed to pivot freely at the mounting point
- Webbing should be allowed to pull on hardware in plane (straight)

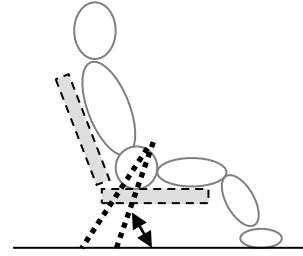

Position of the Cam Lock or Latch and Link

- Centered on the body 1 to 2 inches below the belly button when all belts are tightened

## CROTCH BELT – 6-POINT

Sports Car “Shell Type Seat” and aluminum seats with single crotch belt hole forward of the inside seat back from 10 to 12 inches: (*NOTE: Seats with a single hole positioned more than 12 inches from the inside seat back are designed for 5 point belt installations and may not be as effective for 6-point installations*):

- Crotch Belt Angle: -20° (2" rearward) through the hole
- Two separate anchors 4 to 6 inches apart (x)

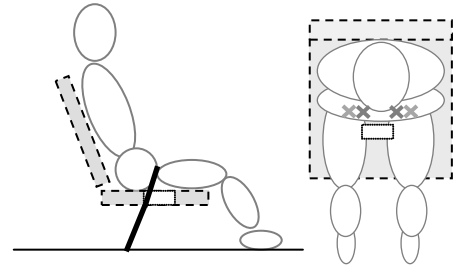

Containment Seats with Crotch belt mounting directly to seat bottom OR through holes provided at the back of the seat bottom: (*Driver is sitting on the Crotch belts*)

- Crotch Belt Angle -10° to -20° from the perpendicular just in front of the crotch with anchors 4 to 6 inches apart (x)

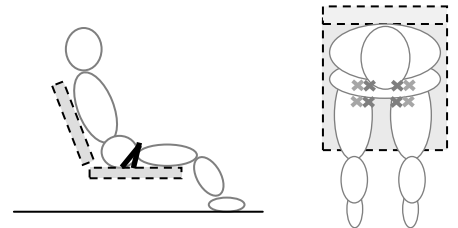

OR

- Crotch Belt Angle Horizontal rearward to under the butt or to the back of the seat (x)

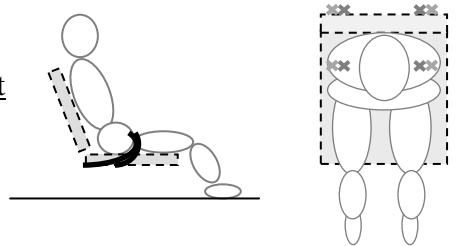

Option (typically for single-seat wide cockpits):

Crotch Belt mounting to the front side of the outboard lap anchors. (Option not illustrated)

Considerations:

- Routing of crotch belts should have a clear and unobstructed path to the mounting point

## CROTCH BELT – 5-POINT

Sports Car “Shell Type Seat” and aluminum seats with single crotch belt hole forward of the inside seat back from 11 to 13 inches:

- Crotch Belt Angle: Chest line to 20° through the hole
- Crotch Belt should never wrap around the front of the seat – there should be a pass through
- Crotch belt is used only to maintain position of the lap belt

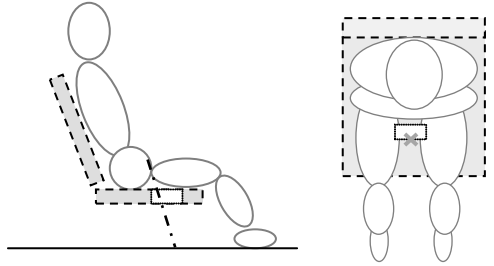

## NEGATIVE G BELT – (7<sup>TH</sup> POINT)

Negative G Strap Angle: 20° to 25° (Chest line extension on a 25° seat back angle)

- Used in conjunction with a 6-point crotch belt system as an additional point to maintain the position of the lap belt in “Negative G” i.e. rollovers

