



AIRCHARGER®

INSTALLATION INSTRUCTIONS

63-1106
FORD / MAZDA
 2004-08 RANGER
 2004-07 B3000
 V6-3.0L

NOTE: This kit was not designed to fit vehicles with a body lift.

TOOLS NEEDED:

Flat Blade Screwdriver
 Pliers
 5/8 Wrench
 10mm Wrench
 Ratchet
 Extension
 10mm Socket
 13mm Socket
 14mm Socket
 Drill
 5/8" drill bit

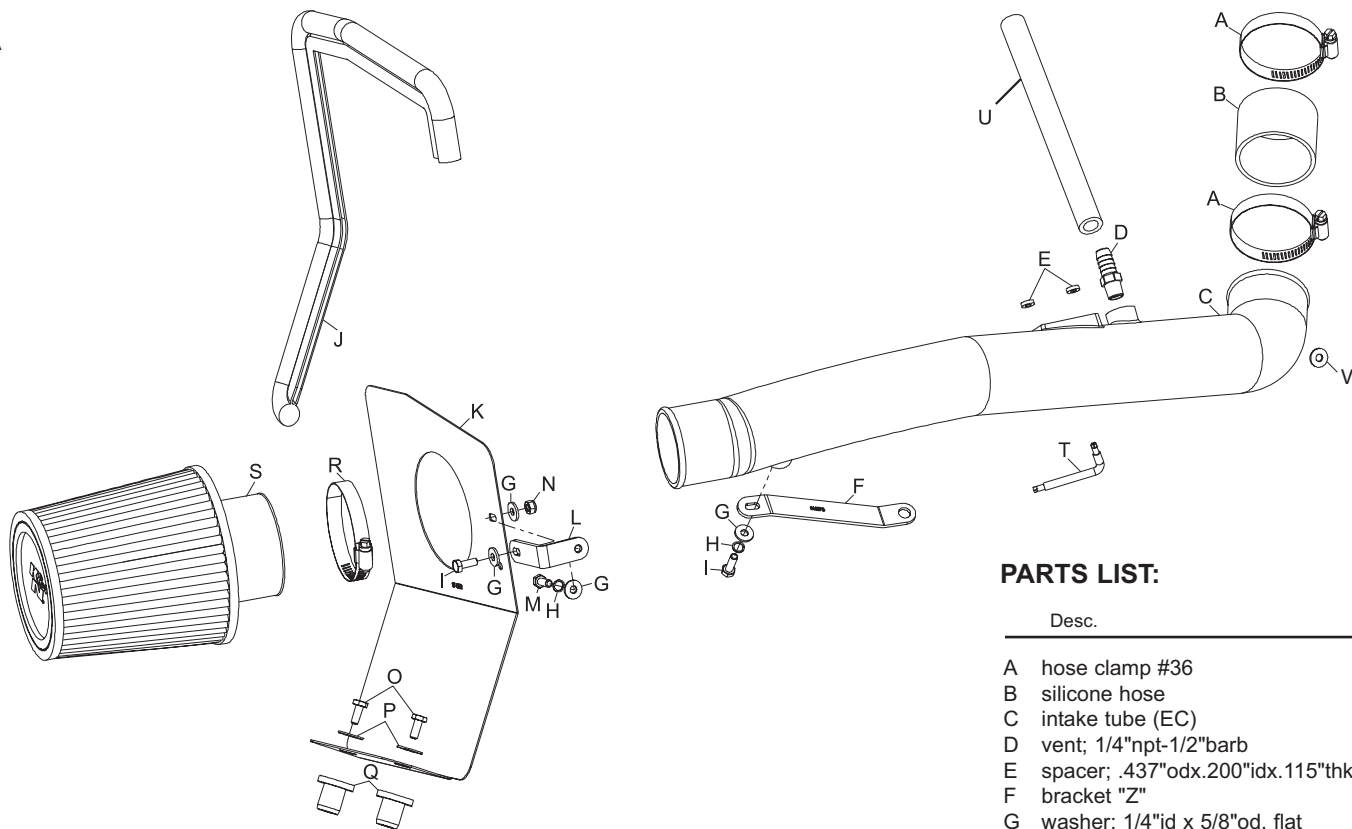

PARTS LIST:

Desc.	Qty.	Part #
A hose clamp #36	2	08530
B silicone hose	1	08405
C intake tube (EC)	1	087130
D vent; 1/4"npt-1/2"barb	1	080022
E spacer; .437"odx.200"idx.115"thk	2	06503
F bracket "Z"	1	010078
G washer; 1/4" id x 5/8" od, flat	4	08275
H washer; 1/4" split lock	2	08198
I bolt; 6mm-1.00x16mm, hex head	2	07703
J edge trim 26"	1	102488
K heat shield	1	074028
L bracket "L"	1	070932
M bolt; 6mm-1.00 x 20mm, hex head	1	07865
N nut; 6mm nylock	1	07553
O bolt; 3/8-16 x 1.25", hex head	2	07779
P washer; 3/8", flat	2	08134
Q insert; 3/8-16x3/4x5/16l rubber	2	08163
R hose clamp # 40	1	08554
S air filter	1	RX-4860
T wrench; torx t20 t/r	1	69801
U hose; 1/2" id x 14" l	1	08402
V grommet	1	08100

NOTE: FAILURE TO FOLLOW INSTALLATION INSTRUCTIONS AND NOT USING THE PROVIDED HARDWARE MAY DAMAGE THE INTAKE TUBE, THROTTLE BODY AND ENGINE.

TO START:

1. Turn the ignition OFF and disconnect the vehicle's negative battery cable.



2. Disconnect the mass air electrical connection, and then disconnect wiring harness from intake tube.



3. Rotate the green locking tab counter clockwise, and then disconnect the crank case vent from intake tube as shown.



3a. On vehicles equipped with a brake booster breather line, disconnect the breather line from the factory 90deg fitting as shown.



3b. Cut the clamp which secures the 90deg fitting to the stock intake hose and then remove the fitting as shown.



4. Loosen the hose clamps at the throttle body and the factory air box, and then remove the intake tube from the vehicle as shown.



5. Remove crank case vent tube from valve cover as shown.



6. Slide a flat blade screwdriver in between the airbox and the airbox mounting tray. Pry downward on the tray, while pulling upwards on the airbox assembly to release the assembly from the retaining grommets in the tray.



7. Pull firmly on the air inlet duct to release the duct from the radiator core support as shown.



8. Remove the two mass air retaining screws with the torx wrench provided, and then remove the mass air sensor as shown.

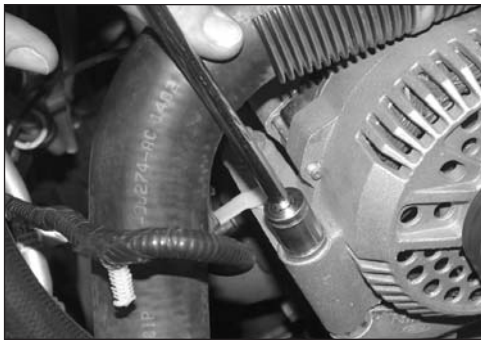

9. Loosen and remove the lower front alternator hex bolt as shown.



10. Mount the tube-mounting bracket (010078) onto the new K&N intake tube with the provided hardware as shown.

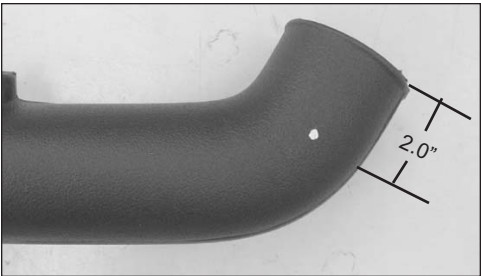

10a. On vehicles equipped with a brake booster breather line, measure 2.0" from the outlet end of the tube and mark the location to be drilled.



10b. On vehicles equipped with a brake booster breather line, drill a 5/8" id hole into the K&N intake tube at the location marked in step #10a and install the provided grommet.

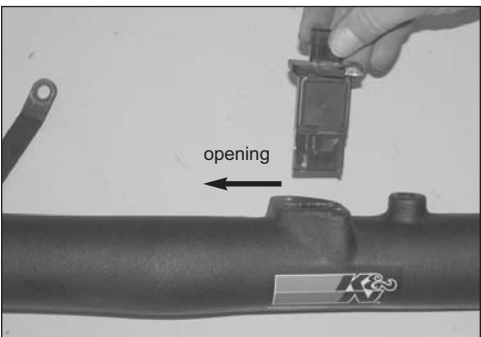

11. Install the mass air sensor into the K&N intake tube with the open end of the sensor pointed towards the filter end of the tube.



12. Secure the mass air sensor with the factory retaining screws removed in step #8 and spacers provided.



13. Install the vent fitting into the new intake tube as shown.

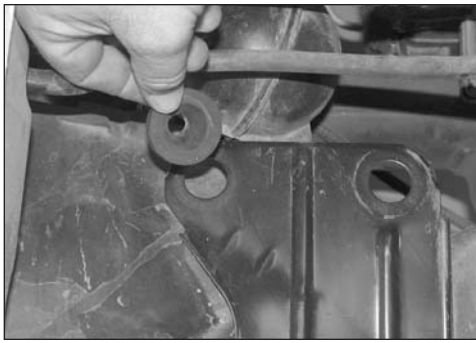

14. Remove the two air box mounting grommets from the air box mounting bracket as shown.



15. Install the provided silicone hose (08405) onto the throttle body as shown.



16. Install the intake tube onto the throttle body, then using the bolt removed in step #9 secure the bracket onto the alternator as shown.



16a. On vehicles equipped with a brake booster breather line, install the factory 90deg fitting removed in step #3b into the grommet installed into the K&N intake tube in step #10b.



16b. On vehicles equipped with a brake booster breather line, connect the vent line to the 90deg fitting installed in step #16a.



17. Using small pliers, squeeze the cooling system reservoir hose-retaining clip through the large hole in the top of the core support, and then remove the clip from the radiator core support.



18. Remove the wiring harness mounting bolt shown from the radiator core support.



19. Install the edge trim onto the heat shield as shown. Trim if needed.



20. Install the "L" bracket (070932) onto the heat shield as shown, with the provided hardware.

NOTE: Do not completely tighten at this time.



21. Install the threaded inserts to the air box-mounting bracket as shown.



22. Install the heat shield into the vehicle using the 3/8" bolts and washers provided threaded into the inserts installed in step #21.

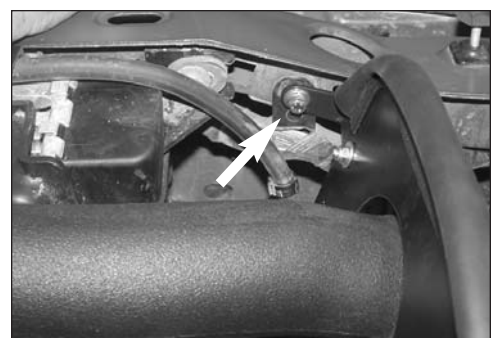

23. Fasten the heat shield mounting bracket to the core support with the bolt and lock washer provided passing through the wiring harness mount into the core support as shown.

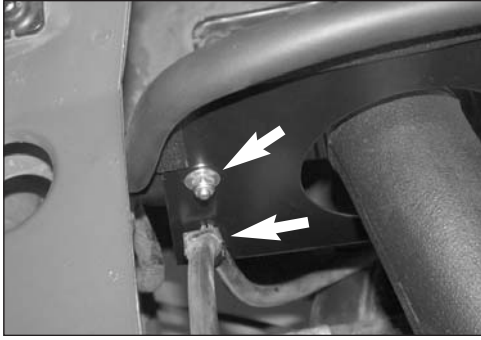

24. Attach the coolant reservoir house clip to the heat shield as shown.



25. Using a razor blade slit the plastic tube and then remove the tube from the valve cover fitting as shown.

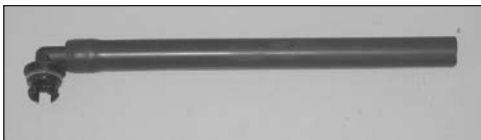

26. Attach the provided silicone hose (08402) onto the valve cover fitting as shown.



27. Re-install the valve cover fitting into the valve cover and then attach the silicone hose onto the K&N intake tube as shown.



28. Install the K&N air filter onto the intake tube and secure with the provided hose clamp as shown.

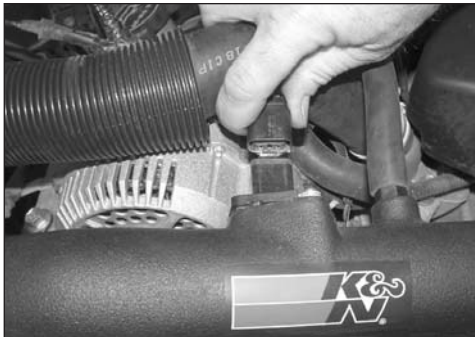

29. Reconnect the mass air electrical connection as shown.



30. Reconnect the vehicle's negative battery cable. Double check to make sure everything is tight and properly positioned before starting the vehicle.

31. It will be necessary for all Aircharger's to be checked periodically for realignment, clearance and tightening of all connections. Failure to follow the above instructions or proper maintenance may void warranty.

ROAD TESTING:

1. Start the engine with the transmission in neutral or park, and the parking brake engaged. Listen for air leaks or odd noises. For air leaks secure hoses and connections. For odd noises, find cause and repair before proceeding. This kit will function identically to the factory system except for being louder and much more responsive.

2. Test drive the vehicle. Listen for odd noises or rattles and fix as necessary.

3. If road test is fine, you can now enjoy the added power and performance from your kit.

4. K&N suggests checking the Air filter element periodically for excessive dirt build-up. When the element becomes covered in dirt (or once a year), service it according to the instructions on the Recharger service kit, part number 99-5050 or 99-5000.

FREE K&N DECAL To register your warranty, please see us online at knfilters.com/register. FREE K&N DECAL