



AIRCHARGER[®]

HIGH-FLOW INTAKE KITS

INSTALLATION INSTRUCTIONS

63-2556
FORD/LINCOLN
2006-08 F-150
2006-08 MARK LT
V8-5.4L

NOTE: This kit was not designed to fit vehicles with a body lift.

TOOLS NEEDED:

- Flat Blade Screwdriver
- Ratchet
- Extension
- 10mm Socket
- 13mm Socket
- 9/16 Socket
- 2.5mm Allen
- 4mm Allen
- Drill
- 1/8" drill bit
- Phillips screwdriver

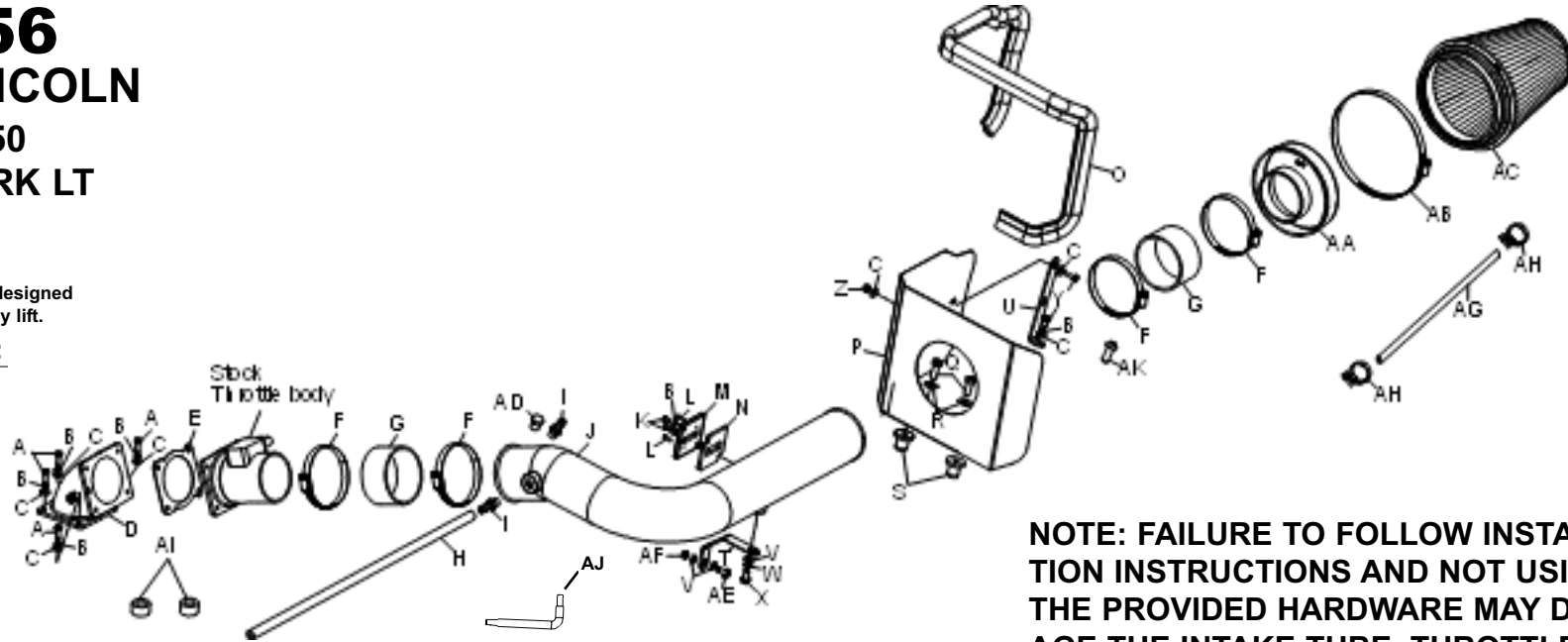

NOTE: FAILURE TO FOLLOW INSTALLATION INSTRUCTIONS AND NOT USING THE PROVIDED HARDWARE MAY DAMAGE THE INTAKE TUBE, THROTTLE BODY AND ENGINE.

PARTS LIST:

Description	Qty.	Part #	Description	Qty.	Part #	Description	Qty.	Part #
A bolt; 6mm-1.00 x 20mm hex	4	07865	K bolt; 6mm-1.00x10mm bha	2	07730	U bracket	1	070026
B washer 1/4" split lock	7	08198	L bolt; m4-.7x12mm, bha	2	07726	V washer; 5/16" id x 5/8"od	3	08276
C washer 1/4" id x 5/8" od	7	08275	M adapter #420	1	21515	W washer; 8mm wave	1	08239
D adapter #430	1	21516	N gasket	1	09069	X bolt; 8mm-1.25x16mm	1	07844
E gasket	1	09070	O edge trim 55"L	1	102480	Y bolt; 6mm-1.00 x 10mm	2	07863
F hose clamp #56	4	08620	P heat shield	1	074021	Z nut; m6 nylock	1	07553
G silicone hose	2	08630	Q bolt; 3/8-16 x 1 1/4 hexhead	2	07779	AA adapter #380	1	21512
H silicone hose	1	08403	R washer; 3/8" id flat, ss	2	08134	AB hose clamp #104	1	08697
I npt 1/4-3/8 barb	2	08047	S insert	2	08163	AC air filter	1	RF-1020
J intake tube (FH)	1	087178	T bracket	1	26656	AD npt 1/4" plug	1	08032
						AE bolt; 8mm-1.25 x 35mm	1	07784
						AF nut; 8mm nylock	1	07542
						AG hose; 3/8" x 30" silicone	1	08614
						AH hose clamp; #6 mini	2	08407
						AI spacer;.625"odx.375"idx.625"l, zn	2	07849
						AJ wrench, torx t20	1	69801
						AK screw; #12 sheet metal 5/8"L	1	07788

TO START:

1. Turn the ignition OFF and disconnect the vehicle's negative battery cable.



2. Disconnect mass air sensor electrical connection.



3. Rotate crank case vent hose locking ring and pull crank case vent hose off of air filter housing. Unhook wiring harness retaining clip from air box.

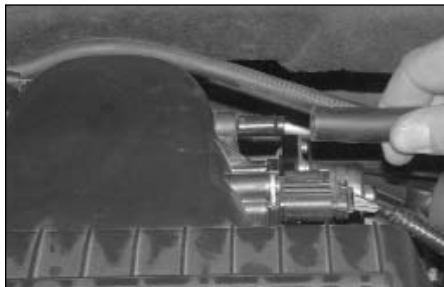

3a. Disconnect the brake booster vent line from the air filter housing as shown.

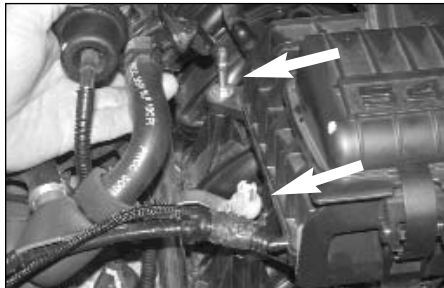

3b. Pull up on the heater control valve and wiring harness mounting clips to unhook them from the air box mounting studs as shown.

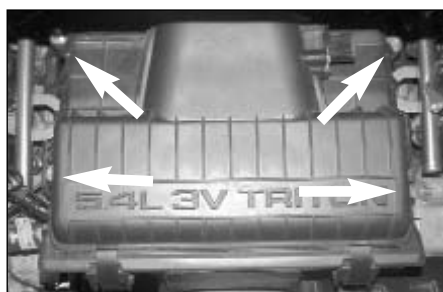

4. Remove the four air box mounting bolts shown with a 10mm socket.



5. Remove the intake tube mounting bolt shown.



6. Remove the entire intake tube & filter assembly from vehicle.
NOTE: K&N recommends that customers do not discard factory air intake.



7. On vehicles that are equipped with the intake tube support bracket, remove the two 13mm nuts securing the intake tube support bracket, remove the intake tube support bracket.



8. On vehicles that are equipped with the intake tube support bracket, reinstall one of the 13mm nuts removed in step #7 onto the lower mounting stud and tighten.

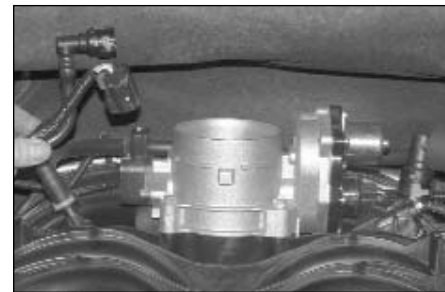

9. Disconnect TPS sensor electrical connection from throttle body.

10. Remove the four 10mm bolts retaining the throttle body to the intake manifold.



11. Lift throttle body from intake manifold. Then disconnect throttle body motor electrical connection.

NOTE: Take caution to avoid dropping debris down intake manifold throat.



12. Using the bolts removed in step #10, secure the throttle body to the K&N throttle body adapter with the gasket as shown.



13. Install the throttle body assembly onto the intake manifold with the hardware provided as shown.



14. Reconnect the throttle body motor and TPS electrical connections.



15. Install "L" bracket (#070026) onto the heatshield with the hardware provided as shown.



16. Install the edge trim onto the heatshield as shown. Trim if needed.



17. Install the provided nut inserts into the air box mounting holes as shown.



17a. Loosen the coolant recovery hose, hose clamps, and then remove the factory recovery hose shown. Be sure to catch any coolant, which flows out of the radiator during hose removal.

NOTE: Be sure to let the engine cool completely before removing the overflow hose or hot coolant will escape from the radiator and injury or damage may result.

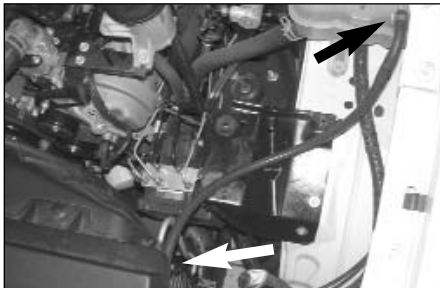

17b. Install the supplied coolant recovery hose and secure with the provided hose clamps.

NOTE: Be sure to replace the coolant that was recovered during hose removal by replenishing it in the coolant recovery tank.



18. Install the heatshield as shown and secure with the provided hardware.

NOTE: Due to manufacture inconsistencies, some vehicles may not be equipped with threaded hole in the factory filter mounting plate. It will be necessary to drill a 1/8" hole in the air filter mounting plate and attach the heat shield bracket with the sheet metal screw provided.



19. Remove the two screws that secure the mass air sensor to the air box with the wrench provided, then remove the mass air sensor.



20. Install the provided gasket onto the K&N mass air adapter as shown. Sticky side down.

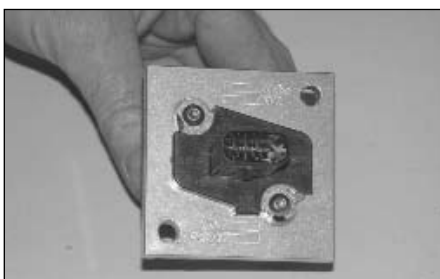

21. Install the mass air sensor into the K&N mass air adapter as shown and secure with the provided hardware.

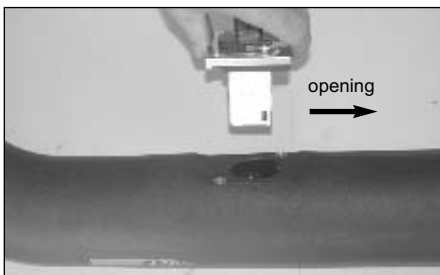

22. Install the mass air sensor assembly into the K&N intake tube.

NOTE: Make sure the open end of the mass air sensor is towards the filter end of the tube.



23. Secure the mass air sensor assembly onto the new K&N intake tube with the provided hardware as shown.



24. Install the provided NPT fittings into the intake tube as shown.



24a. On vehicles that are equipped with only one vent line, install the provided NPT plug as shown.



25. Install the tube mounting bracket (26656) onto the K&N intake tube as shown with the provided hardware.



26. Install silicone hose (#08630) onto the throttle body with the provided hose clamps as shown.



27. Install the K&N intake tube into the silicone hose and then tighten the provided hose clamp.



28. Connect the new intake tube to the bracket with the provided hardware as shown.

INSTALLATION INSTRUCTIONS

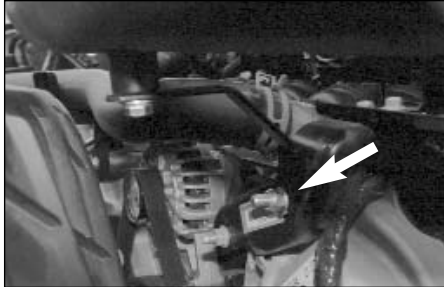

28a. On vehicles not equipped with the factory intake tube support bracket, it is necessary to use the supplied 8mm bolt, washers and nut to secure the tube mounting bracket to the engine bracket as shown.



29. Unlock the crank case vent hose and remove the hose from the valve cover.



30. Install the provided silicone vent hose onto the valve cover and onto the K&N intake tube as shown.



30a. Install the factory brake booster vent hose to the K&N intake tube as shown.



30b. Re-install the factory air box mounting studs with the provided spacers as shown.

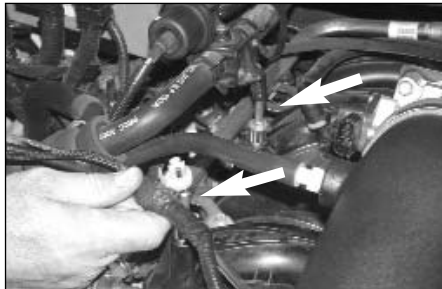

30c. Re-install the heater control valve and wiring harness mounting clips onto the air box mounting studs as shown.



31. Reconnect the mass air sensor electrical connection.



32. Install the silicone hose (#08630) onto the K&N filter adapter and secure with the provided hose clamp as shown.

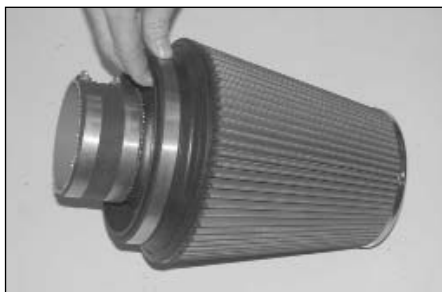

33. Install the adapter assembly into the K&N air filter as shown.



34. Install the K&N Air filter assembly onto the K&N intake tube as shown and secure with the provided hose clamp.



35. Reconnect the vehicle's negative battery cable. Double check to make sure everything is tight and properly positioned before starting the vehicle.

36. It will be necessary for all Aircharger's to be checked periodically for realignment, clearance and tightening of all connections. Failure to follow the above instructions or proper maintenance may void warranty.

ROAD TESTING:

1. Start the engine with the transmission in neutral or park, and the parking brake engaged. Listen for air leaks or odd noises. For air leaks secure hoses and connections. For odd noises, find cause and repair before proceeding. This kit will function identically to the factory system except for being louder and much more responsive.

2. Test drive the vehicle. Listen for odd noises or rattles and fix as necessary.

3. If road test is fine, you can now enjoy the added power and performance from your kit.

4. K&N suggests checking the Air filter element periodically for excessive dirt build-up. When the element becomes covered in dirt (or once a year), service it according to the instructions on the Recharger service kit, part number 99-5050 or 99-5000.

FREE K&N DECAL To register your warranty, please see us online at knfilters.com/register. FREE K&N DECAL