



INSTALLATION INSTRUCTIONS

Part Number: 66-1201

Do not attempt to install this filter top until you have read and completely understand these installation instructions. Proper installation requires basic automotive hand tools and a reasonable amount of mechanical knowledge.

- 1.) Disconnect the vehicle's negative battery cable.
- 2.) Remove the wing nut that retains the stock air cleaner lid in place.
- 3.) Remove the OE air cleaner lid; it will not be used with this product in place.
- 4.) This X-stream top lid is designed specifically to conform to the K&N replacement air filter element designated for your vehicle.
- 5.) **Stud usage and placement directions:**
 - **1968-1987** Carbureted vehicles (single stud): Re-use stud, if preferable. If not, use supplied all thread (**cut length to fit**).
 - **1987-1992** Fuel injected vehicles (single stud): Remove stock stud and replace it with supplied Z-stud.
 - **1993-1995** Fuel injected vehicles (dual stud): Using a 8mm wrench, remove the air cleaner studs from the throttle body bolts. Insert the supplied Z-stud into the threaded hole located just in front of and in between the two throttle ports.
- 6.) With the primary round air filter in place, install the X-stream top. (Fig. 1 and 2)
- 7.) Position for best clearance (Fig. 3), affix washers and nylock nut onto stud (Fig. 4) then tighten all hardware to secure proper sealing onto air filter. **Be sure stud thread protrudes through nylock nut at least 1/16"**. (Fig. 5)
- 8.) Re-connect battery cable. Double check to make sure that everything is tight and properly positioned before starting the vehicle.



Fig. 1



Fig. 2



Fig. 3

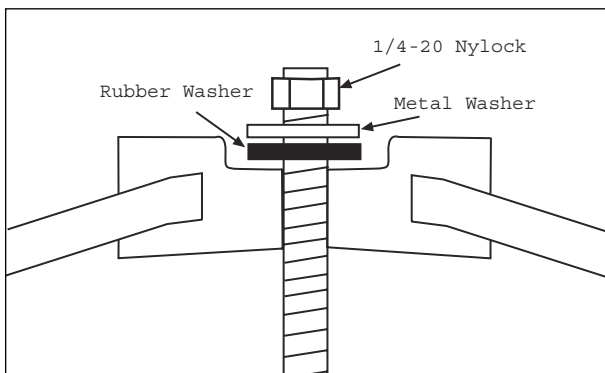

Fig. 4

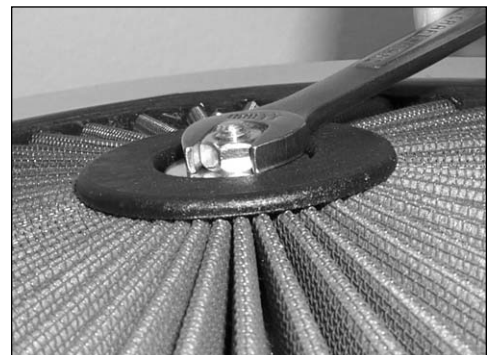

Fig. 5