



TYPHOON INTAKE SYSTEMS

INSTALLATION INSTRUCTIONS

69-2542
DODGE
2008-09 Avenger
L4-2.4L

TOOLS NEEDED:

8mm Socket
10mm Socket
13mm Socket
13mm Wrench
10mm Wrench
Ratchet
Extension
Flat Blade Screwdriver
Pliers

PARTS LIST:

Description	Qty.	Part #
A Hose Clamp #40	3	08554
B Hose; 2-1/2" ID x 2"L Strt. Blk.	1	08441
C Intake Tube	1	27413TS
D Bracket; "L" Twist, FB/PC	1	06716
E Bolt; 8mm-1.25 x 16mm, HexHd.	3	07844
F Washer; 8mm Spring (Wave)	3	08239
G Washer; 5/16" ID x 5/8"OD, Flat	3	08276
H Bolt; M6 x 1.00 x 20mm Hex., SS	1	07795
I Washer; 1/4" Lock, ZN	2	08198
J Washer; 1/4"ID x 5/8"OD - SAE	6	08275
K Hose Clamp #10 Mini	1	08411
L Grommet; 1" OD, 1/2"ID, 1/2" Thk.	1	08064
M Caplug ;15/16" ID, 3/4" L, Blk.	1	08246
N Hose Clamp #16	2	08413
O Hose; 1-1/8" ID x 2"L. Blk. Silic.	1	084074
P Edge Trim (30")	1	102489
Q Heat Shield	1	07684
R Bolt; 6MM-1.00 x 16MM, SS	3	07812
S Nut; 6MM Nylock, HexHd., SS	2	07512
T Bracket; "L", Fin.	1	07093
U Air Filter	1	RU-4860

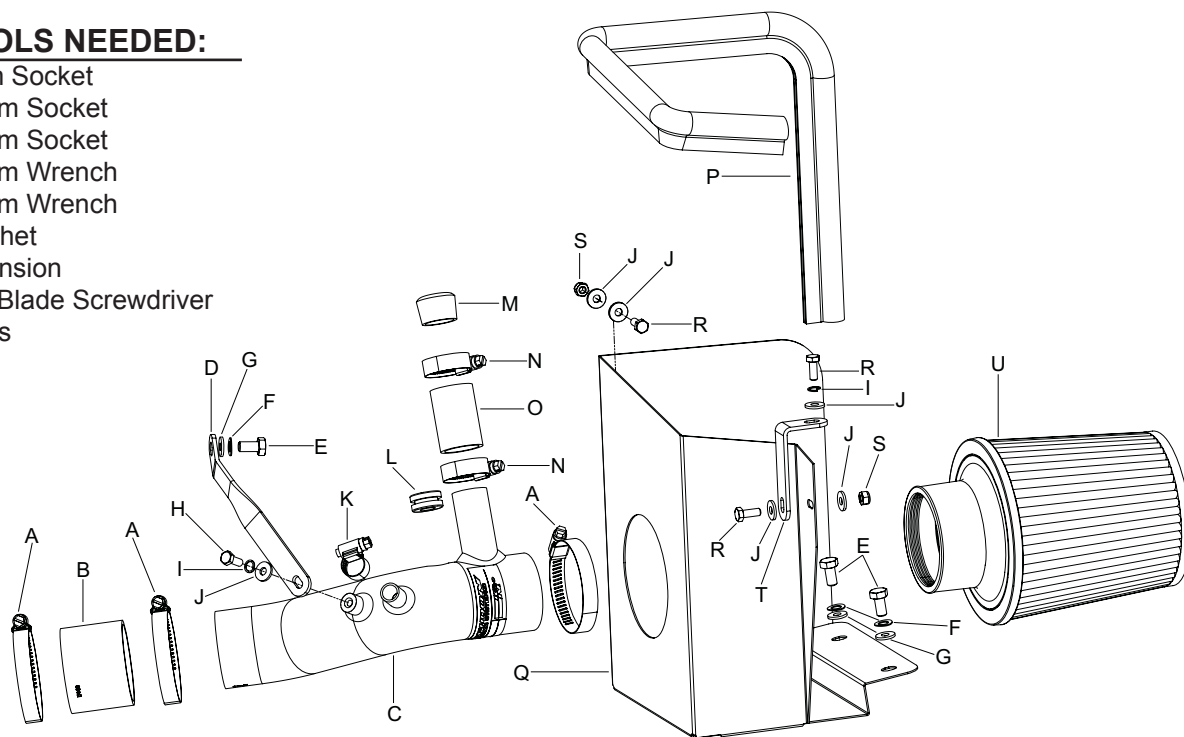

NOTE: FAILURE TO FOLLOW INSTALLATION INSTRUCTIONS AND NOT USING THE PROVIDED HARDWARE MAY DAMAGE THE INTAKE TUBE, THROTTLE BODY AND ENGINE.

TO START:

1. Turn off the ignition and disconnect the negative battery cable.

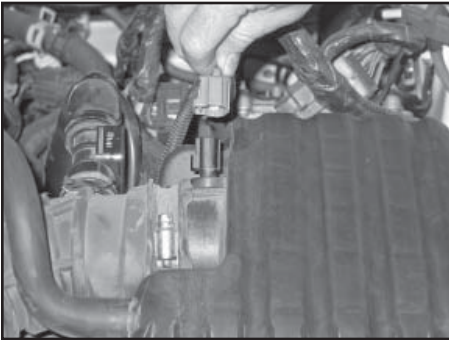

2. Disconnect the inlet air temperature sensor electrical connection.



3. Disconnect the crank case vent hose from the upper air box housing.



4. On vehicles equipped with an air injection pump, release the air injection valve spring clamp and then disconnect the air injection valve from the upper air box.

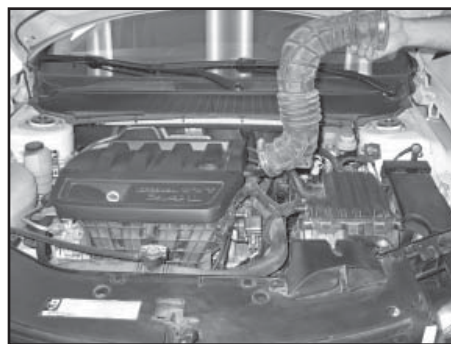

5. Loosen the hose clamps which secure the intake hose to the throttle body and air box, then remove the intake hose from the vehicle.

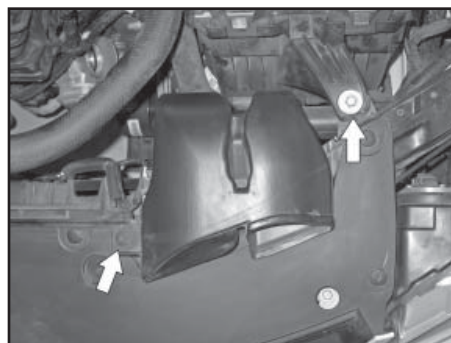

6. Remove the bolt which secures the air box to the radiator core support shown and then remove the plastic retaining clip which secures the fresh air inlet scoop.

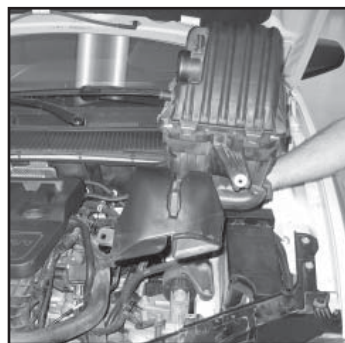

7. Lift up firmly on the air box to dislodge it from the mounting grommets and then remove the air box from the vehicle.

NOTE: Be sure to unhook the battery cable mounting bracket from the air box before removing the air box completely.
NOTE: K&N recommends that customers do not discard factory air intake.

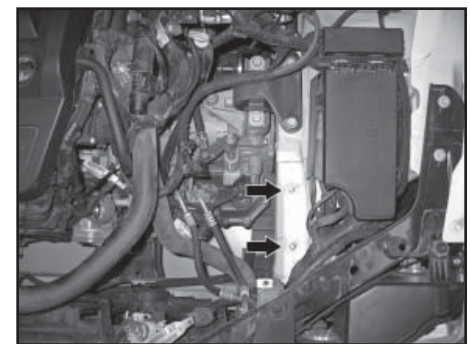

8. Remove the two air box mounting studs shown.

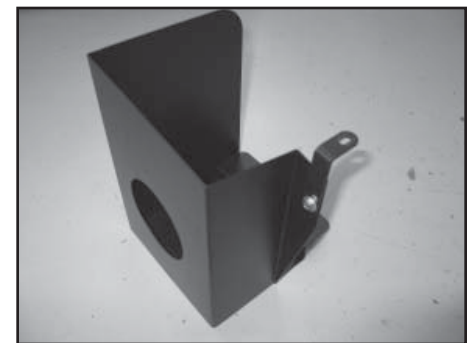

9. Secure the heat shield mounting bracket (07093) onto the heat shield as shown using the provided hardware.



10. Install the provided edge trim onto the heat shield as shown.

NOTE: Some trimming of the edge trim will be necessary.

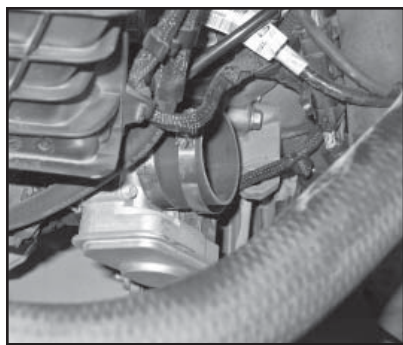

11. Install the provided silicone hose (08441) onto the throttle body and secure with the provided hose clamp.



12. Install the tube mounting bracket (06716) using the provided hardware.

NOTE: The bracket will bolt to the ear on the transmission with the 8mm threaded hole.

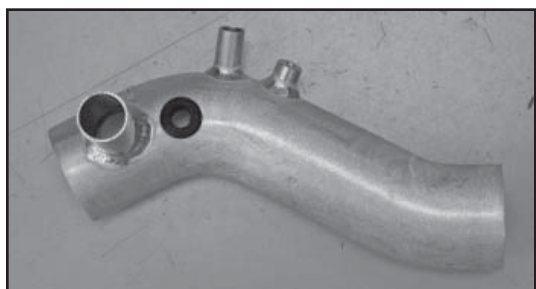

13. Install the provided temperature sensor grommet into the K&N intake tube as shown.

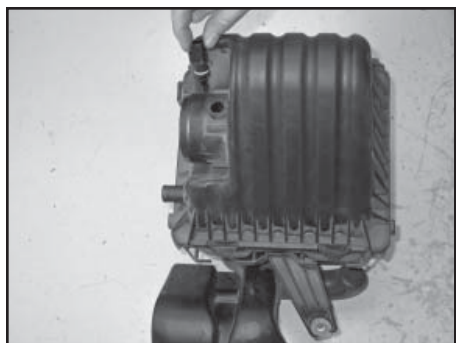

14. Remove inlet air temperature sensor from the stock air box and then remove the o-ring from the sensor.

NOTE: The air temperature sensor is very fragile, care should be taken while handling.

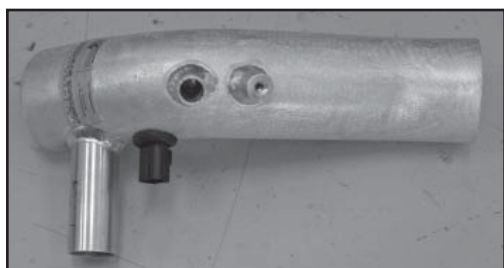

15. Install the air temperature into the grommet installed into the K&N intake tube during step #13.



16. On vehicle not equipped with an air injection pump, install the provided vent cap onto the air fitting and secure with the provided hose clamp.



17. On vehicles equipped with an air injection pump, install the silicone hose onto the vent tube and secure with the provided hose clamp.



18. Install the K&N intake tube into the silicone hose at the throttle body and align with the bracket installed in step #11. Then secure the intake tube with the hose clamp and hardware provided.

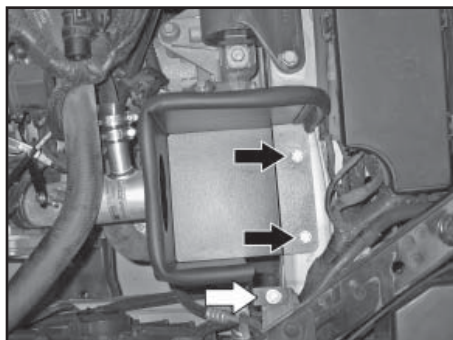

19. Install the heat shield assembly as shown. Secure the heat shield to the air box mounting locations with hardware provided.



20. Attach the crank case vent hose to the K&N intake tube and secure with the provided hose clamp.

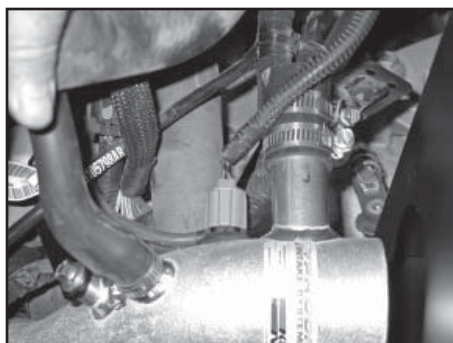

21. Reconnect the inlet air temperature sensor electrical connection.

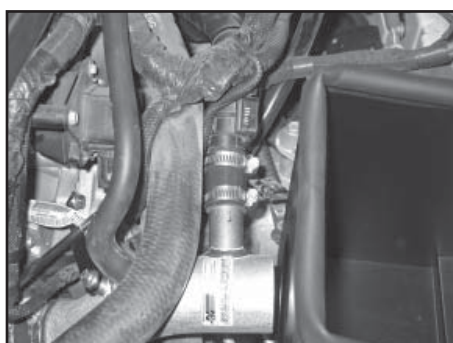

22. On vehicles equipped with an air injection pump, reroute the hose under the engine wiring harness and then connect it to the intake tube and secure with the provided hose clamp.

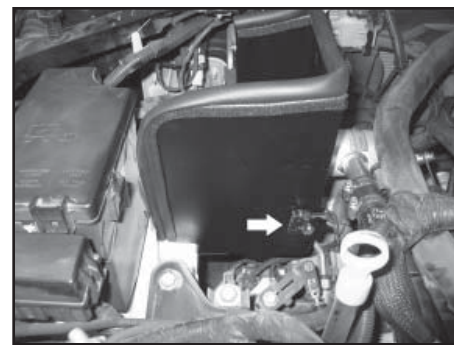

23. Secure the battery cable mounting bracket to the heat shield using the provided hardware.

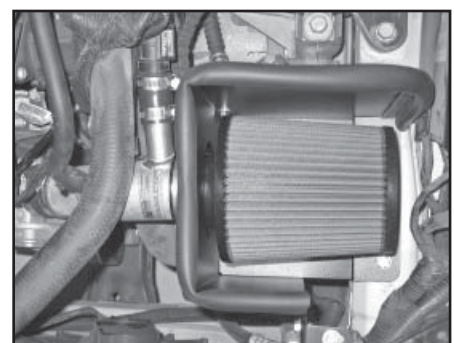

24. Install the K&N Air Filter onto the K&N intake tube and secure with the provided hardware.

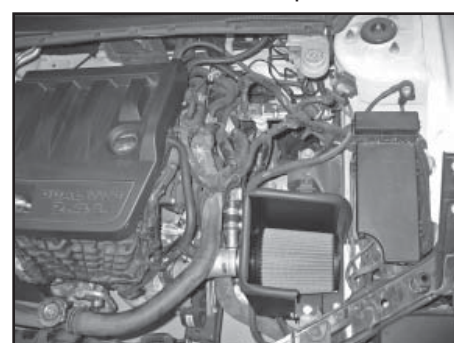

25. Reconnect the negative battery cable.

26. Reconnect the vehicle's negative battery cable. Double check to make sure everything is tight and properly positioned before starting the vehicle.

27. It will be necessary for all K&N Performance Intake Kit's to be checked periodically for realignment, clearance and tightening of all connections. Failure to follow the above instructions or proper maintenance may void warranty.

ROAD TESTING:

1. Start the engine with the transmission in neutral or park, and the parking brake engaged. Listen for air leaks or odd noises. For air leaks secure hoses and connections. For odd noises, find cause and repair before proceeding. This kit will function identically to the factory system except for being louder and much more responsive.

2. Test drive the vehicle. Listen for odd noises or rattles and fix as necessary.

3. If road test is fine, you can now enjoy the added power and performance from your kit.

4. K&N suggests checking the air filter element periodically for excessive dirt build-up. When the element becomes covered in dirt (or once a year), service it according to the instructions on the Recharger service kit, part number 99-5050 or 99-5000.