

2004- FORD F-150 - V8 4.6/5.4L SHORT BED MODELS

DIAGRAM 1

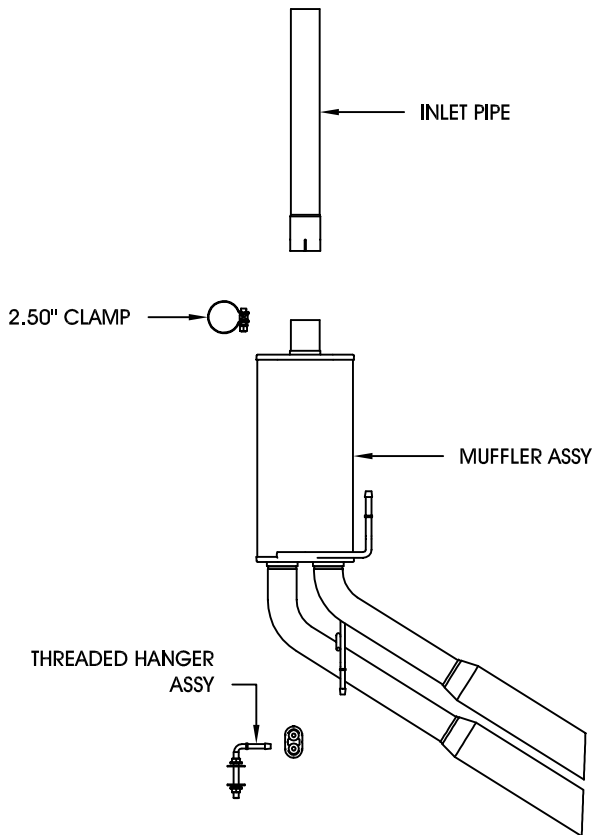

DIAGRAM 2



Warning: When working on, under, or around any vehicle exercise caution. Please allow the vehicle's exhaust system to cool before removal, as exhaust system temperatures may cause severe burns. If working without a lift, always consult vehicle manual for correct lifting specifications. Always wear safety glasses and ensure a safe work area. Serious injury or death could occur if safety measures are not followed.

Step 1: (Carefully read all instructions before installation)

Disconnect the vehicle's battery before removal of the OEM exhaust. This will allow the computer to reset itself with the new system, and prevent electrical accidents. To remove the OEM exhaust system, loosen the clamp attaching the muffler to the catalytic converter extension pipe. Disengage the welded hangers on the muffler and tailpipe from the OEM rubber insulators, then remove the muffler and tailpipe (Do not damage the OEM rubber insulators, as they will be re-used to mount the new system.) You may need to cut the tailpipe approximately 1" behind the muffler to aid in removal.

Step 2: Install the new inlet pipe using the OEM clamp. Leave all clamps and fasteners loose for final adjustment of the complete system. Install the threaded hanger and rubber insulator as shown in Diagram 2, then install the muffler fitting the welded hangers into the rubber insulator(s) and fasten it to the inlet pipe using the supplied 2.50" clamp.

Step 3: With all components mounted loosely, adjust the system for overall aesthetics and clearance of frame & bodywork. (MAGNAFLOW recommends at least 1/2" of clearance between the exhaust system and any body panels to prevent heat-related body damage or fire.)

Step 4: Once a final position has been chosen for the new system, evenly tighten all fasteners from front to rear. The supplied band clamps must be VERY tight to properly align the pipes and prevent leaks (Approximately 65ft-lbs). You can now connect the battery, start the vehicle, and check for leaks. Inspect all fasteners after 25-50 miles of operation and retighten if necessary.

*MAGNAFLOW Performance Exhaust recommends professional installation on all their products

Technical support: 1-800-959-9226 ext. 4500