

INSTALLATION INSTRUCTIONS FOR 16854

2008-2009 Mini Cooper Clubman 1.6L

Warning: When working on, under, or around any vehicle exercise caution. Please allow the vehicle's exhaust system to cool before removal, as exhaust system temperatures may cause severe burns. If working without a lift, always consult vehicle manual for correct lifting specifications. Always wear safety glasses and ensure a safe work area. Serious injury or death could occur if safety measures are not followed.

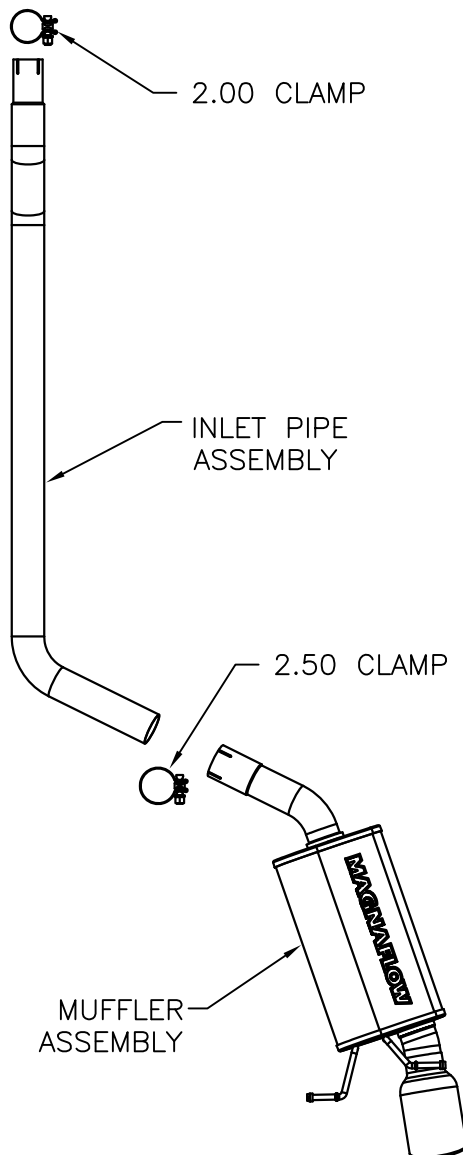

Step 1: (Carefully read all instructions before installation) It is necessary to cut the OEM exhaust system to facilitate removal, to do this use a Sawzall or similar tool to cut the the exhaust 10.00" from the back of the factory resonator. Next disengage the welded hangers from the rubber insulators of the Muffler and extract from the vehicle. Do not discard or damage the rubber insulators, as they will be used to mount the new system

Step 2: Install the Inlet Pipe Assembly by using the supplied 2.00" clamp. Using the supplied 2.50" clamp, install the Muffler Assembly and insert the welded hangers into the OEM rubber insulators.

Step 3: With all components mounted loosely, adjust the system for overall aesthetics and clearance of frame & bodywork. (MAGNAFLOW recommends at least 1/2" of clearance between the exhaust system and any body panels to prevent heat-related body damage or fire.)

Step 4: Once a final position has been chosen for the new system, evenly tighten all fasteners from front to rear. The supplied band clamps must be VERY tight to properly align the pipes and prevent leaks (Approximately 65ft-lbs). Inspect all fasteners after 25-50 miles of operation and retighten if necessary.