

Monocrystalline Folding Solar Panels

**SPFP1120, SPFP1120-K,
SPFP1200 & SPFP1200-K**

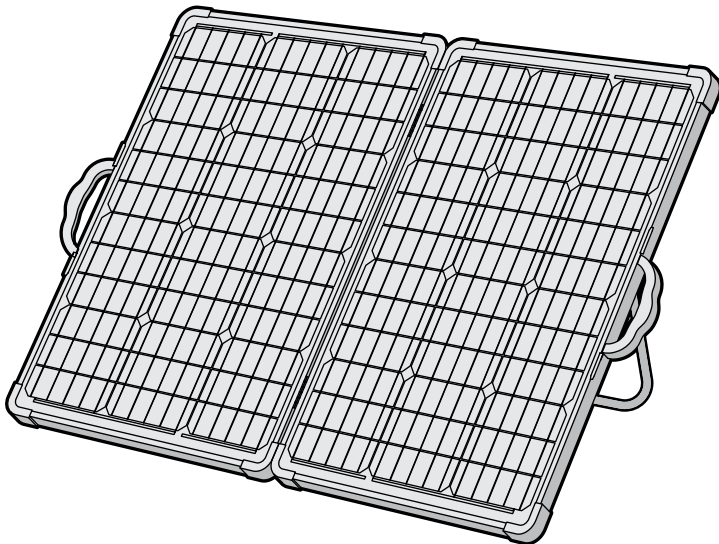

MONOCRYSTALLINE FOLDING SOLAR PANELS

REDARC folding solar panels are designed to provide a solar charging solution for your auxiliary battery. They feature the folding panel with 50 Amp Anderson Plug connection and a strong nylon carry bag.

WARNING & SAFETY INSTRUCTIONS

SAVE THESE INSTRUCTIONS — THIS MANUAL CONTAINS IMPORTANT SAFETY INSTRUCTIONS FOR REDARC MONOCRYSTALLINE SOLAR PANELS.

DO NOT operate Monocrystalline Solar Panels UNLESS YOU HAVE READ AND UNDERSTOOD THIS MANUAL and the Panel is installed as per these installation instructions. REDARC recommends that the Panel be installed by a suitably qualified person.

WARNING

RISK OF EXPLOSIVE GASES:

Working in vicinity of a Lead-Acid battery is dangerous. Batteries generate explosive gases during normal operation. For this reason, it is of utmost importance that you follow the instructions when installing and using the Solar Panel. Check the manufacturers data for your battery and ensure that the 'Absorption' voltage of the regulator you select does not exceed the manufacturers recommended maximum charging voltage. If the 'Absorption' voltage for your battery type is too high, please select another charging profile or regulator (regulator not included).

CAUTION

1. This appliance is not intended for use by persons (including children) with reduced physical, sensory or mental capabilities, or lack of experience and knowledge, unless they are supervised or have been instructed on how to use the appliance by a person responsible for their safety. Children should be supervised to ensure that they do not play with the appliance.
2. Do NOT connect the Solar Panel directly to a Battery. A Solar Regulator must be used between the Solar Panel and the Battery.
3. Only use the Solar Panel for charging Lead Acid, Gel, Calcium content, AGM or Lithium Iron Phosphate 12V batteries using a Solar Regulator suitable for the Battery's chemistry.

Check the manufacturer's data for your battery and ensure that the 'Maximum' voltage your Solar Regulator's profile and does not exceed the manufacturer's recommended maximum charging voltage. If the 'Maximum' voltage is too high for your battery type, please select another charging profile.

4. The Battery should be mounted in a well ventilated area, as far as possible from any ignition sources. NEVER smoke or allow a spark or flame in the vicinity of battery or engine. This may cause the battery to explode.
5. An unconnected panel exposed to light may generate voltages greater than 20V on their leads. Completely cover all panels with an opaque material during installation, and when connecting or disconnecting your panel to reduce the chance of an electrical spark.
6. The Solar Panel will achieve best results when proper battery maintenance is regularly performed. This includes but is not limited to checking water and specific gravity levels of the battery.
7. Do not use mirrors or other devices to artificially concentrate sunlight on the panel.
8. All panels used in series, parallel, or series-parallel should be positioned to receive identical amounts of light to reduce risk of panel damage.
9. Partially shaded or partially obscured solar panels will have reduced output, and can potentially damage the solar panel.

PERSONAL SAFETY PRECAUTIONS

10. To assist with the safe operation and use of the Solar Panel when connected (via a Regulator) to the battery:
 - a) Wear complete eye protection and clothing protection. Avoid touching eyes while working near a battery.
 - b) If battery acid contacts your skin or clothing, remove the affected clothing and wash the affected area of your skin immediately with soap and water. If battery acid enters your eye, immediately flood the eye with running cold water for at least 10 minutes and seek medical assistance immediately.

WARNING

Check the manufacturers data for your battery and ensure that the 'Absorption' voltage of the regulator you select does not exceed the manufacturers recommended maximum charging voltage. If the 'Absorption' voltage for your battery type is too high, please select another charging profile or regulator (regulator not included).

CONTENTS

Monocrystalline Folding Solar Panels	1
Supplied Parts	2
The Folding Solar Module	3
120 Watt Monocrystalline Folding Panel	4
200 Watt Monocrystalline Folding Panel	5
Solar Optimisation	6
Angle to the Sun	6
System Wiring	7
Installation Notes	7
System Installation	8
Standard Setup 120 W or 200 W	8

SUPPLIED PARTS

1. Monocrystalline folding solar panel
2. Padded carry bag
3. 5 m / 16.4 ft Anderson-to-Anderson extension cable SRC0018 (kit only)
4. 1.5 m / 5 ft Anderson-to-battery clip cable SRC0009 (kit only)
5. Solar regulator (kit only)

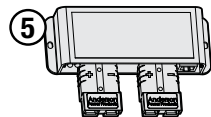
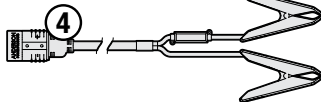
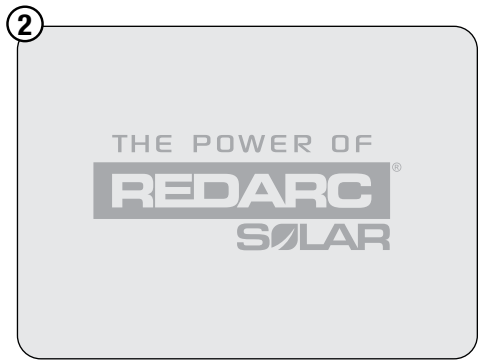
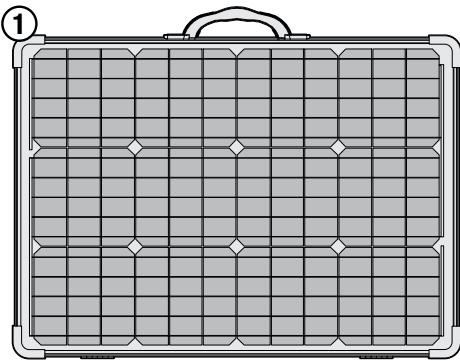

THE FOLDING SOLAR MODULE

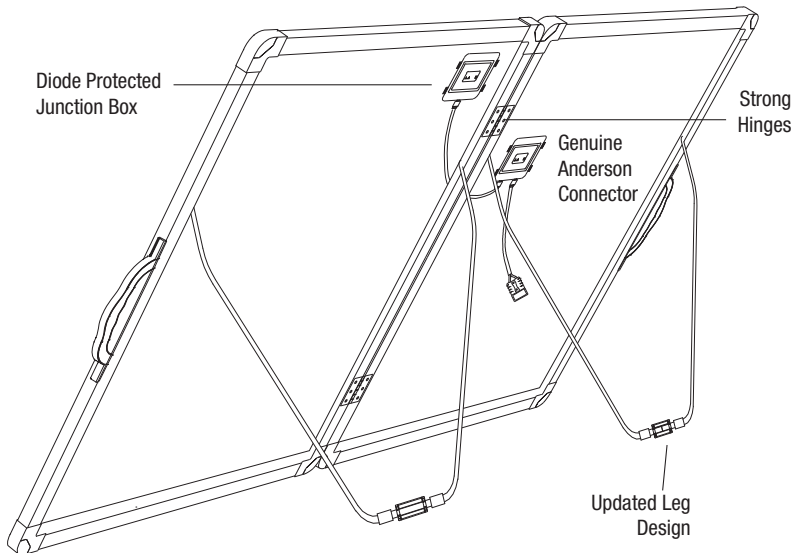
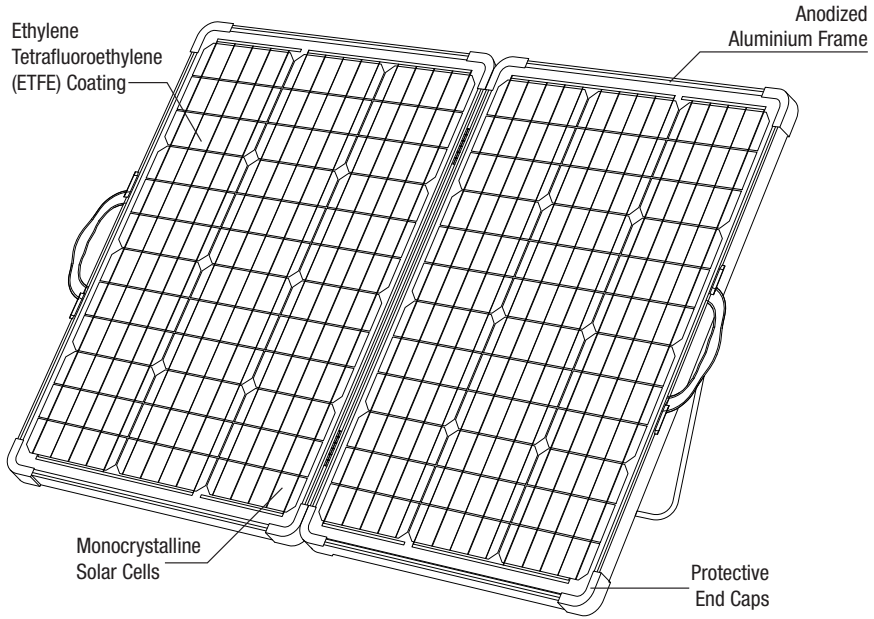

120 WATT MONOCRYSTALLINE FOLDING PANEL

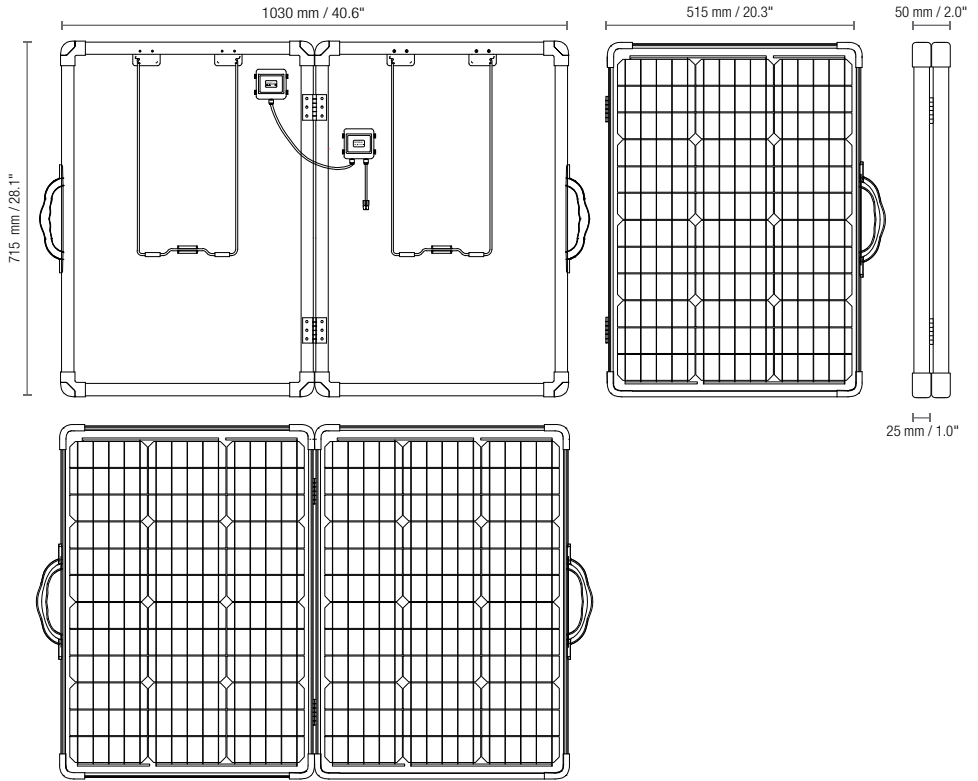

SPECIFICATIONS

Model	SPFP1120	Operating temperature	-40°C to +85°C / -40°F to +185°F
Peak power	120 W (2 × 60 W)		
Cell construction	Monocrystalline	Max power voltage	20.0 V
Frame	Anodized aluminium	Max power current	6.0 A
Cable length	300 mm / 1 ft	Open circuit voltage	24.0 V
Connection type	50 A Anderson	Short circuit current	6.48 A
Dimensions (closed)	515 × 715 × 50 mm / 20.3 × 28.1 × 2.0"	Power tolerance	±3%
Dimensions (open)	1030 × 715 × 25 mm / 40.6" × 28.1" × 1.0"	Standard test conditions	AM1.5 1000 W/m ² 25°C / 77°F
Conversion efficiency	20.6%	Net weight	6.3 kg / 13.9 lb

200 WATT MONOCRYSTALLINE FOLDING PANEL

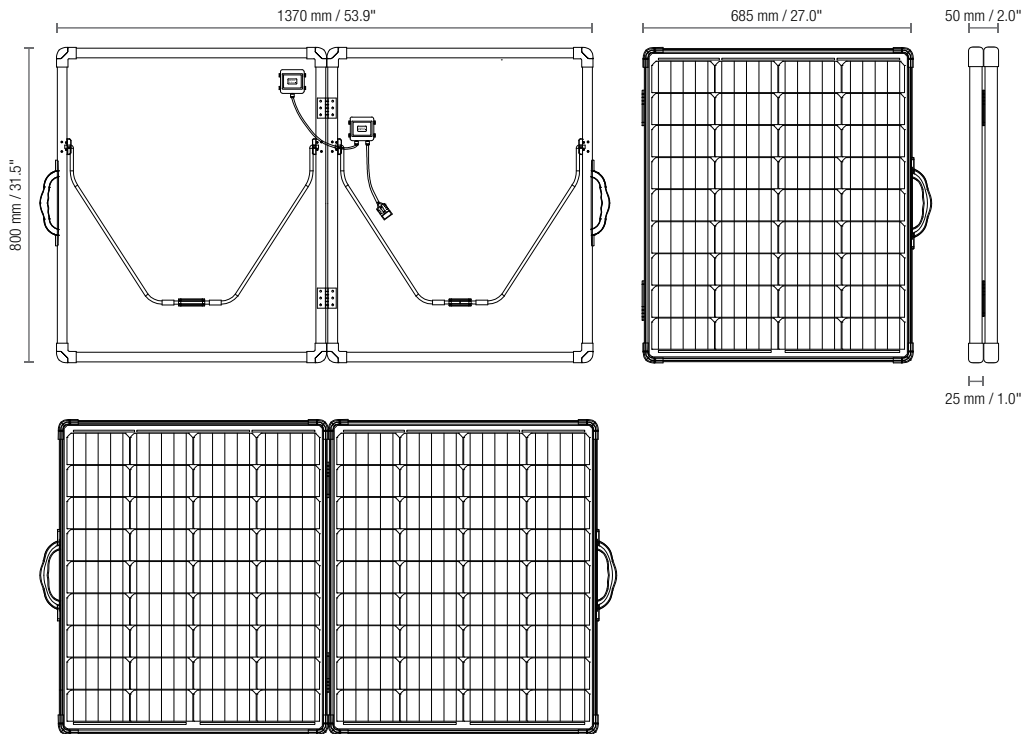

SPECIFICATIONS

Model	SPFP1200	Operating temperature	-40°C to +85°C / -40°F to +185°F
Peak power	200 W (2 × 100 W)		
Cell construction	Monocrystalline	Max power voltage	20.0 V
Frame	Anodized aluminium	Max power current	10.0 A
Cable length	300 mm / 1 ft	Open circuit voltage	24.0 V
Connection type	50 A Anderson	Short circuit current	10.8 A
Dimensions (closed)	685 × 800 × 50 mm / 27.0 × 31.5 × 2.0"	Power tolerance	±3%
Dimensions (open)	1370 × 800 × 25 mm / 53.9" × 31.5" × 1.0"	Standard test conditions	AM1.5 1000 W/m ² 25°C / 77°F
Conversion efficiency	21.8%	Net weight	9.5 kg / 20.9 lb

SOLAR OPTIMISATION

ANGLE TO THE SUN

REDARC solar panels will perform at their peak with the panel face angled directly towards the sun. However, in practice this is not always achievable. REDARC recommends having your panels angled between 20° and 40° from the ground. This will ensure the best total output from your panel across the course of the day, no matter what season.

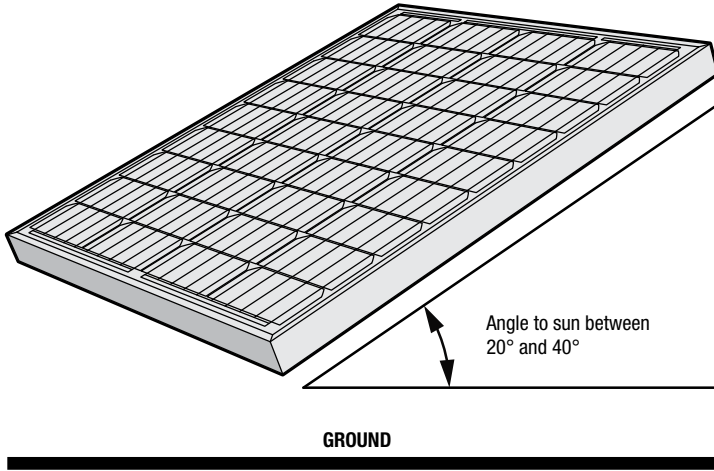

In the southern hemisphere, the sun is always in the NORTHERN half of the sky. As such facing your panel NORTH ensures the best angle to the sun for a solar panel across the course of the day. In the northern hemisphere, the sun is always in the SOUTHERN half of the sky. As such, facing your panel SOUTH ensures the best angle to the sun for a solar panel across the course of the day.

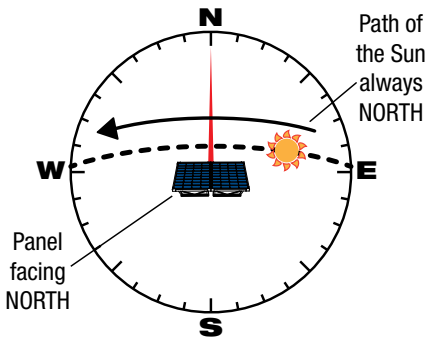

Southern Hemisphere

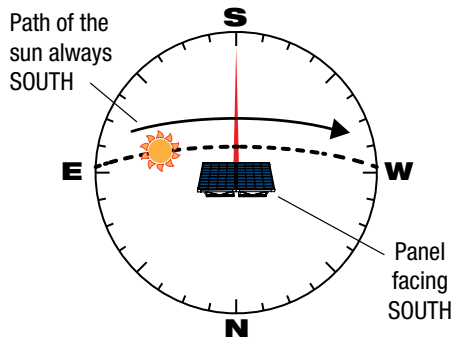

Northern Hemisphere

INSTALLATION NOTES

- Before connecting your solar panel confirm the battery is suitable for use.
- Always ensure the Anderson plug connection is clean, sound and is wired with the correct polarity.
- REDARC recommends the regulator be installed as close as possible to the battery(s). If you need to use different cables ensure their length does not exceed 10 m from the panel to the regulator.
- The supplied Anderson connectors are suitably rated for up to 50 A, if multiple panels are used to the point of exceeding this rating, alternative connectors should be sourced.
- When connecting panels from an existing setup, or non-REDARC brand panels, please ensure that the panels are diode protected, as they may be damaged if they are not.
- Please refer to Solar Regulator manual and Battery Manufacturer's specifications for specific installation instructions.
- Do NOT use the folding panel in windy/gusty conditions. Damage to the panel and or other property may result.
- No NOT use a high pressure hose to clean the folding panel. Use a damp and scratch free cloth to clean panel surfaces.
- Beware of pinch points when operating the legs and folding the panel.

SYSTEM INSTALLATION

STANDARD SETUP 120 W / 200 W

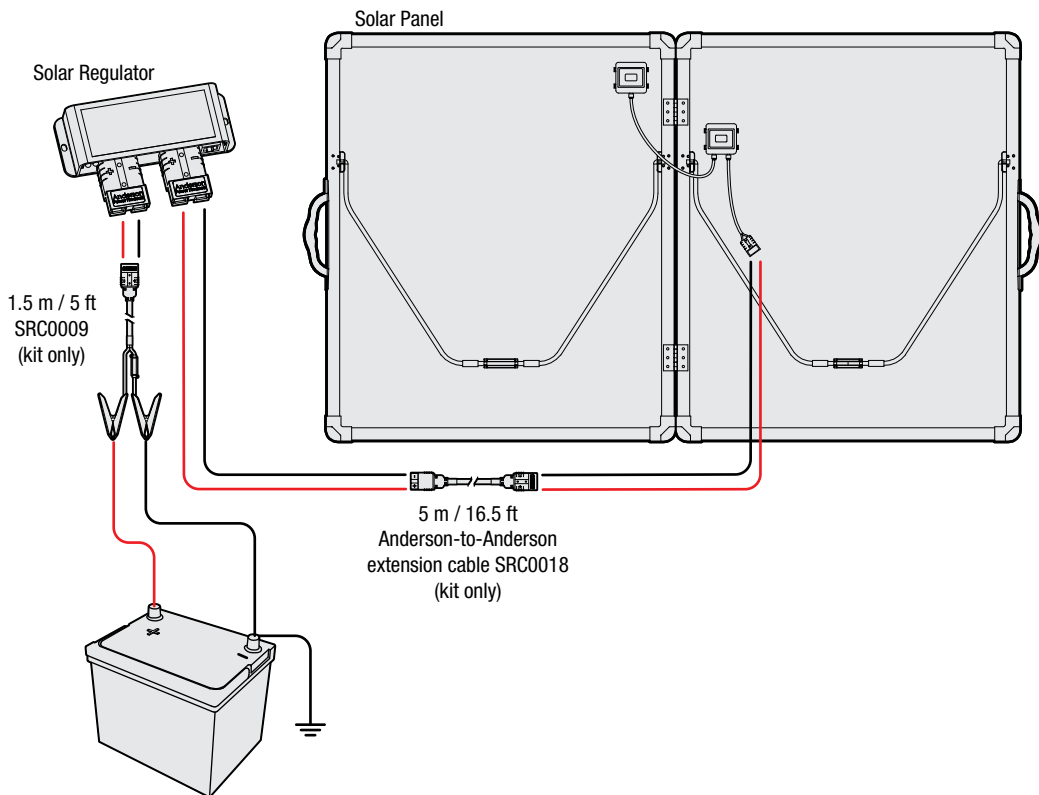

REDARC SOLAR PRODUCT WARRANTY

Limited Warranty

For full warranty terms and conditions, visit the link below or refer to the contact details applicable to your region.

<https://redarc.com.au/warranty>

<https://redarcelectronics.com/warranty>

Australia and New Zealand

www.redarc.com.au

REDARC Electronics Pty Ltd
23 Brodie Road (North),
Lonsdale SA 5160
Australia

Australia +61 8 8322 4848
New Zealand +64 9 222 1024

North America

www.redarcelectronics.com

REDARC Corporation
c/o Shallco, Inc.
308 Component Dr.
Smithfield, NC 27577
USA

USA +1 (704) 247 5150
Canada +1 (604) 260 5512
Mexico +52 (558) 526 2898

NOTES

FREE TECHNICAL ASSISTANCE

For product and technical support contact your regional distributor, call our head office between 8:00 a.m. to 5:30 p.m. Australian Central Standard Time, Monday to Friday, or send us an email.

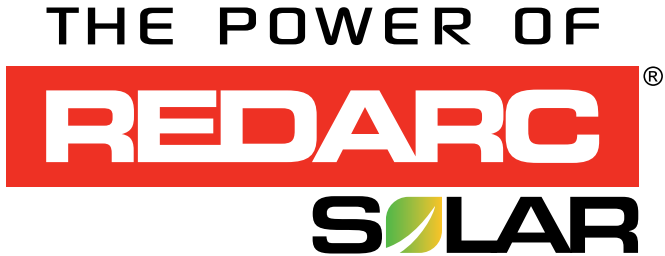

Australia

power@redarc.com.au
www.redarc.com.au
+61 8 8322 4848

New Zealand

power@redarcelectronics.co.nz
www.redarcelectronics.co.nz
+64 9 222 1024

North America

power@redarcelectronics.com
www.redarcelectronics.com

United States

+1 (704) 247 5150

Canada

+1 (604) 260 5512

Mexico

+52 (558) 526 2898

UK/Europe

power@redarcelectronics.eu
www.redarcelectronics.eu
+44 (0)20 3930 8109

www.redarc.com.au