

LOCK-RIGHT™ Performance Locker Installation Manual  
Integral Carrier Axles—C-Clip and non-C-Clip Versions  
Typical of Spicer®, Jeep®, G.M.® 10-, 12-bolt, Ford® 8.8-inch, Toyota® L.C., etc.

Introduction.....2  
Background Information.....3  
Installations Covered.....6  
    Preliminary Steps.....6  
    Determination of Axle Type.....6  
    Differential Case Removal (thick ring gear).....6  
    Disassembly of Differential Case.....8  
    Inspection of the Parts.....9  
    Preparing Parts for Assembly.....10  
    Assembly of the Parts.....10  
    Differential Case Completion.....15  
    Case Final Assembly Into Vehicle.....18

Differential Assembly Inspection.....19  
Vehicle Final Assembly.....19  
Tire Diameters.....21  
Testing Your Installation.....21  
Driving Your Vehicle.....22  
Subsequent Disassembly.....22  
Technical Assistance.....23  
Warranty Information.....23



**WWW.RICHMONDGEAR.COM**

## Introduction

Welcome to the growing family of **LOCK-RIGHT** owners! This manual will help you install your new **LOCK-RIGHT** automatic 100% full-locking differential. When the installation is complete, your vehicle will have *extreme* traction! We trust that you will be pleased with its performance and thank you for your confidence in our products.

**LOCK-RIGHT** installation simply involves disassembling and re-assembling the differential case, replacing a few parts in the process. These instructions are detailed to the point that a person who is reasonably familiar with automotive work can install a **LOCK-RIGHT** into a C-Clip integral carrier axle (and into certain non-C-Clip variants) in about one hour, and into other integral carrier axles in about 2-1/2 hours; please read them carefully before you start to be sure that you thoroughly understand them. Do not attempt shortcuts unless you know exactly what you are doing. These instructions also assume that you have the proper shop

manual for reference to instructions about axle shaft removal, torque values, settings, clearances, etc. that apply to your particular vehicle. Our manual is a general guide to operations but does not contain specific information for each vehicle.

Remember: This instruction manual is provided for your convenience to assist you or your mechanic with the installation of your new **LOCK-RIGHT**. However, the ultimate responsibility for the success of your installation and the subsequent proper operation of your vehicle rest with you, the vehicle owner.

When your installation is complete, you will have a vehicle with significantly increased capabilities. For continued “fun in the sun,” operate it in a safe and responsible manner. *Be sure to read and understand the driving information* in the **LOCK-RIGHT** Vehicle Owner’s Manual!

## Background Information

The differential **case** is the round housing inside the rear axle assembly to which the ring gear is bolted and which contains the differential spider and side gear assembly. It is installed in the differential **carrier**, which is the housing that holds the case, drive pinion gear, bearings, etc. The carrier may be removable (as part of a “drop-out” unit, or third member), or it may be integral (as a permanent part of the axle assembly, mounted in the vehicle). This manual covers the integral carrier design, both C-Clip and non-C-Clip versions.

The **LOCK-RIGHT** is designed to fit into **standard open differential cases only**, not into limited-slip (clutch-pack) type cases. If your vehicle contains a limited-slip unit you will need to purchase a standard open differential case, thrust washers and pinion shaft before proceeding.

A word about axle shaft thrust blocks: A few differentials, such as the Jeep® AMC-20 and the older 19-tooth Spicer®

44 axle, use a thrust block between the inside ends of the axle shafts as a part of the end play adjustment. When installing a **LOCK-RIGHT**, this block is re-used along with the original axles so that the original end play adjustment does not change. However, if the original axles are changed to different original-type axles, the block will continue to be used but the end play must be re-adjusted (see the shop manual for the procedure). If the axle is changed to another type that does not need end-play adjustment, such as a one-piece design, the thrust block may be omitted. (In the Land Cruiser, the block is never used.)

**A word about side gear thrust washers:** All differentials originally had a thrust washer under each side gear. Thrust washers are large in diameter and between about 1/32-inch (.031, or 0,76-mm) and 1/16-inch (.062, or 1,52-mm) thick. If either one or both are missing from the original differential, **obtain new one(s) before proceeding!**

The **LOCK-RIGHT** is designed to be used with a correct thrust washer under **each** coupler, and failure to use this washer is easy to observe during inspection and will void the warranty.

**A word about C-Clips:** Many integral carrier differentials have the axle shafts retained by C-Clips. These are semi-circular pieces of hardened steel, similar to a washer with one side cut out, that fit into a groove in the end of the axle shaft and into a pocket in the side gear. The axle shaft is held in place by the pinion (spider gear) shaft. The **LOCK-RIGHT** is designed for many of these axles, and their installation is covered in this manual. This type of axle is the easiest in which to install a **LOCK-RIGHT**, typically requiring about one hour for the procedure.

**NOTE:** The parts shown in the various figures are typical and may not exactly depict your particular model.

## **LOCK-RIGHT Installations Covered in This Manual**

**Integral carrier axles.** Typical of these is Spicer<sup>®</sup>, Jeep<sup>®</sup> AMC-20, G.M.<sup>®</sup> 10-, 12-, and 14-bolt, Ford<sup>®</sup> 7.5-inch and 8.8-inch, Toyota<sup>®</sup> Land Cruiser; similar axles, with and without C-Clips.

### **Preliminary Steps**

The following steps are only a general guide to preliminary operations used for preparing your vehicle for **LOCK-RIGHT** installation. For detailed information, refer to your shop manual. In general, the preliminary steps include:

- a) Blocking the vehicle**, putting transmission in neutral;
- b) Loosening the wheel lug nuts** (optional with C-Clips and other axles);
- c) Jacking up the axle**; securely resting it on jack stands;

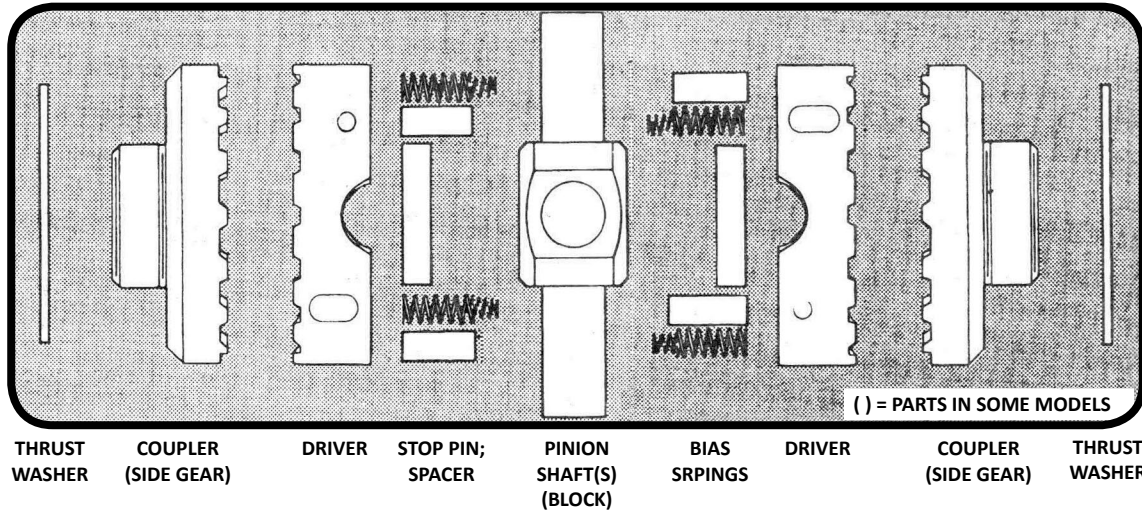

**Figure 1**  
**LOCK-RIGHT Exploded View**

- d) Removing the tires;
- e) Disconnecting the brake lines and emergency brake cables;
- f) Pulling out one or both axles a few inches.

### Determination of Axle Type

1. Remove the differential cover and drain the oil.

2. Inspect to determine axle assembly type. If it is a C-Clip design, proceed directly to Section 2 on page 8. If not, continue with step 3 (next).

3. Determine if the ring gear is thin enough to be able to pull the pinion (spider gear) shaft out past the teeth. If so, proceed directly to Section 2 on page 8. If not, continue with Section 1 (next).

## Section 1: Removal of the Differential Case and Ring Gear Assembly From the Vehicle (thick ring gear)

### Summary of steps in this section:

- 1) Securely block and jack up vehicle
- 2) Pull out axle shafts by about six inches
- 3) Mark carrier and bearing caps
- 4) Observe ring gear backlash amount
- 5) Remove bearing caps
- 6) Remove differential case from carrier
- 7) Remove and mark bearing races
- 8) Remove ring gear
- 9) Install **LOCK-RIGHT**

**1. Perform the operations listed below** and as described in your shop manual that apply to your vehicle. The axle shafts should be pulled out about six inches for differential case removal.

2. Using a center punch, **mark both the carrier and bearing cap on the ring gear side with one punch mark each and on the other side with two marks.** The caps are not interchangeable, because each one is line-bored with the carrier. *These marks are very important to correct re-assembly!*

**3. Rock the ring gear back and forth** to get a “feel” for the amount of backlash present. This amount of rotation will be re-checked when the differential case is installed to determine if it has been done correctly.

**4. Remove the bearing caps and then the differential case** and shims from the carrier as described in the shop

manual (some axle designs may require the use of a carrier spreader tool). Be sure to put a small grind mark on each shim or tag them so that they can be replaced on the same side.

**5. Remove the differential bearing race from the side with one punch mark first.** Put a very small grind mark on the outside of it, or use a tag. Be sure that you can identify it for proper re-assembly on the same side.

**6. Remove the other bearing race.**

**7. Remove the ring gear** from the case. It may need to be tapped off with a brass mallet (see the shop manual). Mark it so that it can be re-installed in the same rotational orientation as when removed.

**8. Proceed to Section 2** (next) for **LOCK-RIGHT** Installation.

## **Section 2: Disassembly of the Differential Case with thin ring gear, and C-Clips (in the vehicle); also with thick ring gear (case removed from vehicle)**

Note: If the axle assembly is a C-Clip design or has a thin ring gear, the differential case remains in the vehicle and the ring gear side axle shaft does not need to be disturbed—it simply remains bolted in place and the **LOCK-RIGHT** installation is done by only partially removing the opposite axle shaft.

**1. Remove the pinion shaft retaining pin**, using a long punch. In the vehicle, the left bearing cap may need to be removed; for **C-Clip** differentials only, unscrew the bolt.

**2. Remove the pinion shaft.**

**3. For C-Clip differentials only:** The C-Clips are located in a groove in the end of each axle shaft and are held in a

pocket in the side gear by the pinion shaft. “Bump” each tire inward slightly to free the clips; they will fall out to free up the internal parts.

**4.** For installations with the **differential case in the vehicle, leave the ring gear side axle bolted in place**; pull out only the other axle shaft about two inches.

**5. Remove the spider gears**, side gears, all washers, and axle shaft thrust block (if used in your assembly).

### **Inspection of the Parts**

**NOTE:** These steps are important. The **LOCK-RIGHT** utilizes your differential case, side gear thrust washers and pinion shaft (plus the axle shaft thrust block, if used), and they must be in excellent condition. The spider gears and washers are not used. If the following inspection shows that anything is bad, buy new parts from your dealer!



**1. Thoroughly clean** the differential case and wash remaining parts with solvent, then dry them.

**2. Inspect the pinion shaft.** Any noticeable grooves or galling may weaken it and can also adversely affect the operation of your new **LOCK-RIGHT**. If it is not in excellent condition, obtain a new one.

**3. Inspect the side gear thrust washers.** They are important to the correct positioning of the **LOCK-RIGHT** parts. If they are excessively worn or are cracked, obtain new ones. If several thicknesses are offered, try to obtain the same size as the old ones. **NOTE:** There should be **TWO** thrust washers of about equal thickness, one under each side gear.

**4. Inspect the thrust block** (if used). Be sure that the ends are smooth and not galled.

**5. Inspect the case** for any chips, cracks or similar damage. Also inspect the bearings, if the case is out of the

vehicle. If the case or bearings look bad, replace them. However, if you do, remember that the shims no longer will be correct; the ring and pinion backlash and bearings pre-load will need to be reset with a dial indicator as described in the shop manual.

## **LOCK-RIGHT Installation**

### **Preparing the Parts for Assembly**

**1. Coat the teeth** of the couplers and drivers, the large center holes of the drivers, and both sides of the thrust washers with medium grease. Also place a little grease in each of the two window holes in each driver. The grease will help hold things in place and assist with functioning until the gear oil circulates.

**2. Place a shear pin into each window hole.** It should be about flush (**Figure 2**).

3. Place a spacer into the center of each driver, wide end toward the teeth if not symmetrical (**Figure 2**).

4. Press a thrust washer (with grease added) onto the back of each coupler.

5. Insert a small spring into each of the large springs and add a little grease to the coils to hold them together. Set them aside.

### Assembly of the LOCK-RIGHT Parts into the Differential Case

#### Summary of steps in this section:

- 1) Install Ring gear side coupler and washer
- 2) Install other coupler and washer
- 3) Install left C-Clip (C-Clips only)
- 4) Install left driver and spacer assembly
- 5) Install other driver (non C-Clip); or
- 6) Install other C-Clip (C-Clips only)

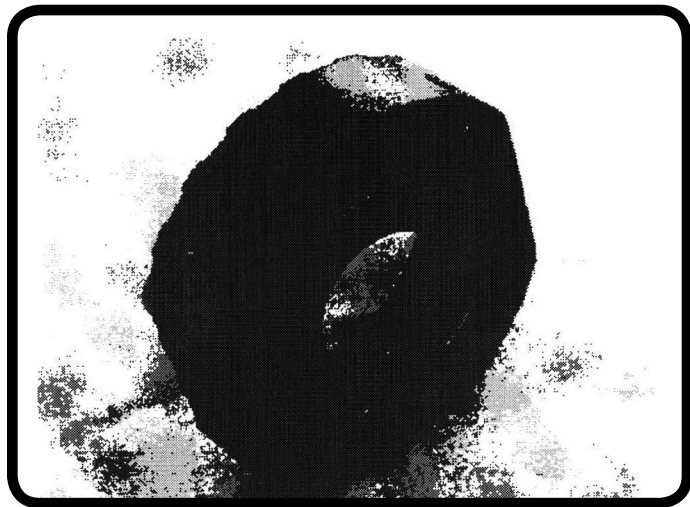

**Figure 2**  
Install shear pins and spacers

1. **Install a coupler and washer assembly** in the ring gear end of the differential case (over the axle splines if in the vehicle). See **Figure 3**. Note that the couplers in some models may have flats for clearance. If an axle shaft thrust block is used, **place it in the center of the second coupler** now if the installation is being done in the vehicle. If not, it may be installed later.

2. **Place the second coupler and washer assembly** into the other end of the differential case (**Figure 3**).

3. **For C-Clip differentials only:** Place a C-Clip with the ends pointing down into the ring gear side axle shaft end groove and pull the tire out sharply to seat the clip (**Figure 3**). Then, carefully push the other axle into the second coupler splines until the end of the axle shaft is even with the coupler surface. Keep the coupler seated in the case. Note: The ring gear is removed for clarity. Ordinarily, the differential case is in the vehicle and the ring gear is in place.



**Figure 3**  
**Install couplers (and left C-Clip if so equipped)**

**4. Important!** Be sure to have the spacers correctly placed in the drivers before doing the following steps!

**Pick up one of the driver-and-spacer assemblies.** Orient its teeth toward the ring gear flange and hold it so that the flats (if present) will clear the sides of the case. Place it on the teeth of the coupler and press it into the grease (**Figure 4**). Reach into the center and push the spacer down onto the coupler shoulder (and over the C-Clip, if so equipped).

**5. For non-C-Clip axles only,** repeat this step for the other driver-and-spacer assembly (**Figure 4**), then **proceed to Section 3** on page 13.

**6. For C-Clip axles only,** follow the steps below to install the second C-Clip and other driver.

- a) **Make a tool** with a piece of stiff wire, such as from a coat hanger. Bend it into a “U” shape about four inches wide at the bottom, with one-inch sides.

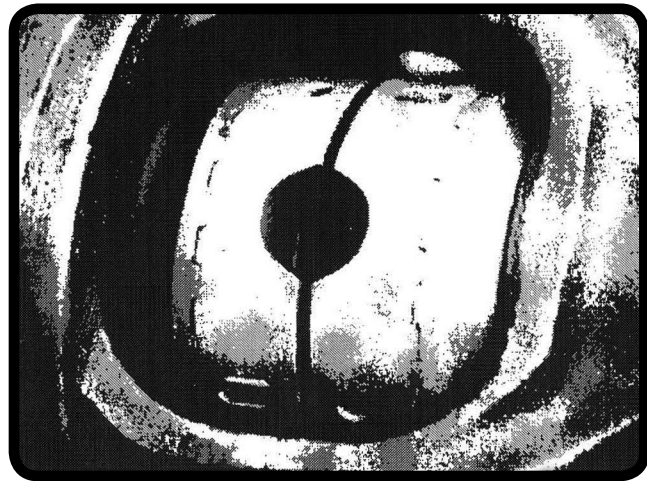

**Figure 4**  
**Non-C-Clip axles—Install drivers; C-Clip—left**

- b) **Place the other driver assembly** in the differential case. Push it to the **left**, touching the other driver (**Figure 5**).
- c) Using the U-shaped wire between the driver and coupler teeth, **push its spacer leftward** into the center of the left driver to help hold it temporarily in place.
- d) **Rotate both drivers** with the **left** tire until the C-Clip installation recess in the right driver teeth is pointing out.
- e) **Tap the right tire inward**, until the bottom of the groove in the end of the axle shaft is even with the surface of the coupler. Keep the coupler seated in the case.
- f) **Slide the other C-Clip** through the recess in the teeth and into the groove in the axle shaft end (**Figure 5**).
- g) **Pull the right tire out sharply** to seat the C-Clip.

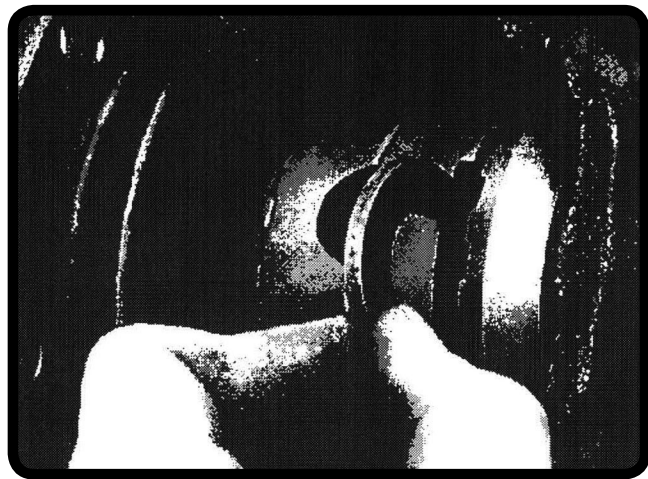

**Figure 5**  
**C-Clip axles—install C-Clip and right driver**

- h) **Rotate the right tire** 1/4-turn until the C-Clip ends are pointing downward, so that it will not fall off.
- i) **Rotate the left tire** to position both drivers so that the large semi-circular recess in the right driver is facing out.
- j) **Push the right driver** to the right and into the grease in the coupler teeth.
- k) Through the semi-circular recess, **push the right spacer** to the right, over the C-Clip and axle shaft end.

### **Section 3: Differential Case Assembly Completion (All Models)**

NOTE: These steps are for the differential case that has been removed from the vehicle and is on the bench, as well as for those remaining in the vehicle.

#### **Summary of steps in this section:**

- a) Rotate drivers; align holes
- b) Push shear pin into other driver

- c) Install spring assembly
- d) Repeat for other pins and springs
- e) Push spacers outward
- f) Install pinion shaft and retaining pin

**1. Rotate the right driver** until one of its long window holes (containing a pin) faces out, and rotate the other driver until one of its empty pin holes lines up with the first window hole.

**2. Push the pin out** of the window hole and into the pin hole in the opposite driver with a small pointed tool (**Figure 6**).

**3. Place one end of a spring assembly** (small spring inside the large one) into the window hole, behind the pin (**Figure 7**). Compress it with a small screwdriver and pop the bottom into the window hole (**Figure 8**).

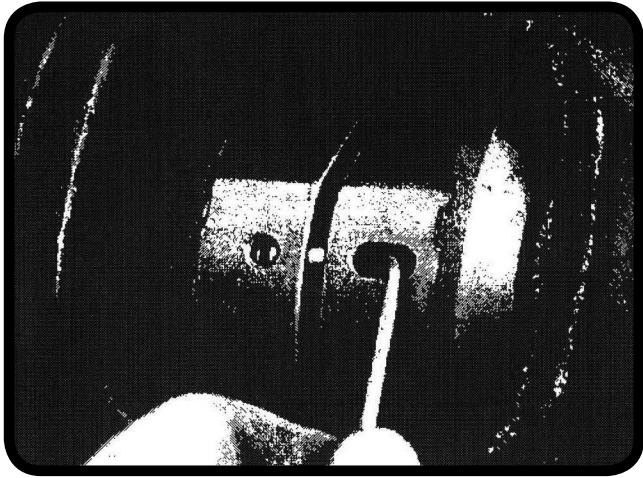

**Figure 6**  
**Push pins into opposite driver**

Push on the bottom coils to be sure that the spring snaps in and is seated all the way. **Rotate the drivers** and do the same procedure for each of the other three pins and springs.

**4. Reach in through the recesses** with your fingers and be sure that the spacers are pushed outward onto the couplers.

**5. Rotate the drivers** so that the large recesses line up with the pinion shaft holes in the differential case.

**6. If an axle shaft thrust block is being used**, push it into the center of the assembly and line up the large hole with the pinion shaft holes. If in the vehicle, push the right axle shaft inward now, into the coupler splines, to move the block to the center.

**7. Carefully insert the pinion shaft** into the hole and guide it through the drivers, past the spacers (and through the thrust block, if used). It should insert easily by hand. If not, tap it in, being very careful not to get the inner end caught on something!

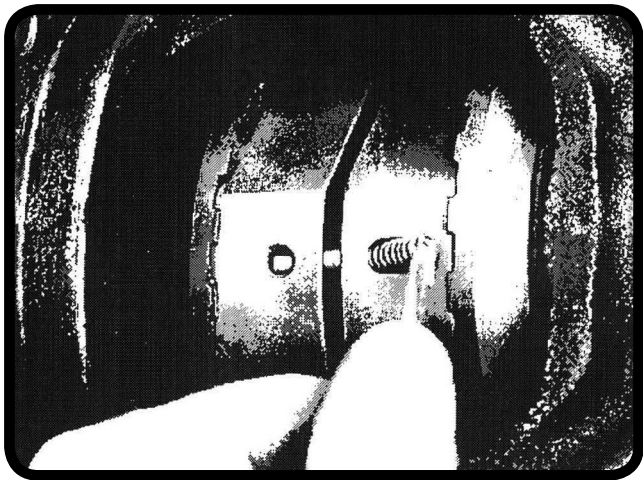

**Figure 7**  
**Install spring assemblies in holes**

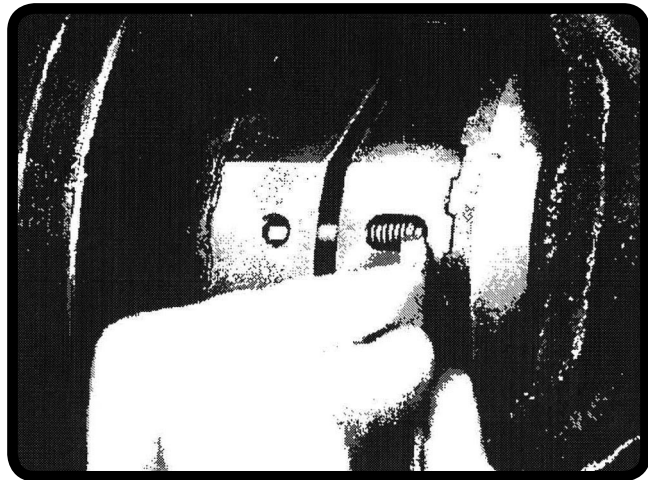

**Figure 8**  
**Snap spring assembly into hole**



Be sure to orient it so that its retaining pin hole will line up with the hole in the differential case (**Figure 9**). If the pinion shaft will not insert, or is hard to insert, be sure that the correct thrust washers are being used and that the spacers are oriented with the widest side (opening) fitting down over the coupler shoulder. Rotate the drivers and couplers back and forth to be sure that they are not binding.

**8. Install the pinion shaft retaining pin.** If the pin is solid, as opposed to a roll pin, slightly deform the metal on the side of the hole to help hold it in place (see the shop manual). For C-Clip Axles only: Screw in and tighten the bolt.

**9. For differential cases out of the vehicle:** The case should still be on the bench after the preceding steps; **install the ring gear** now and torque the bolts. Proceed to the next section.

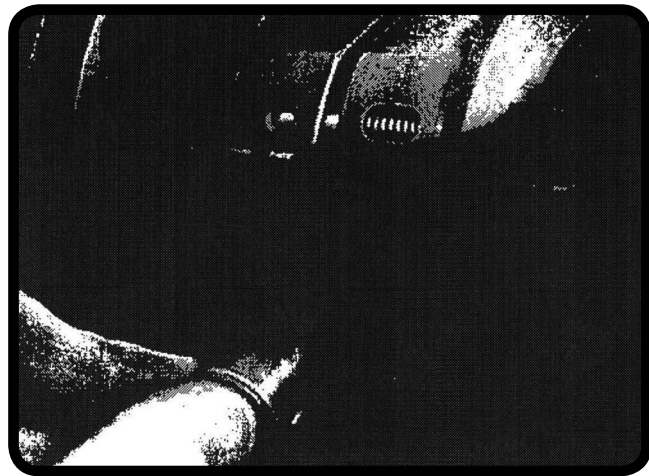

**Figure 9**  
**Install pinion shaft, then pin**

## **Assembly of Differential Case Into Vehicle (thick ring gear; differential case was removed from vehicle)**

- 1. Clean the axle housing interior**, cover, mounting surface and drain plug.
- 2. Place the correct bearing races** onto each end of the differential case, ready to install.
- 3. If shims are used, locate them** near the correct ends of the case, ready to install.
- 4. Install the differential case** in the carrier as described in the shop manual. Generally, this will involve placing the differential case and correctly-located bearing races with one shim into the carrier and then tapping in the shim on the other side, or pressing the case in if the shims are already mounted under the bearings. In some designs a spreader for the housing may be required.
- 5. Replace the bearing caps** in their marked positions and torque the bolts to their correct value. Consult the shop

manual for the exact procedure.

**6. Finish the installation** of any remaining parts by reversing the order of disassembly—in general, the axles/backing plates, brake lines, emergency brake cables, and tires. If your vehicle uses an axle shaft thrust block, be sure that the correct axle shims are in place at the outer ends of the axle shafts. In these designs there should be little or no end play. Also note that in some designs the last 1/8-inch or so of the backing plate installation may be a light press fit and the axle shaft may appear to be hitting something; tap the outside end of the axle shaft and it should go in.

### **Assembly Inspection**

**1. Inspect your work.** Look for anything that is not correct. Be sure that the drivers rotate back and forth smoothly, stopping at the pinion shaft.

Use a light to see that the spacers (and thrust block, if used) are in place and that the springs are working properly.

When the above installation steps are completed, all the parts should be in exactly the same positions as they were when the installation began. **If the differential case has been removed from the vehicle**, the backlash and pre-load settings should be unchanged from before and no further adjustments will be needed. To be certain, **rock the ring gear back and forth** to see if the backlash appears to be the same as it was prior to the installation. If not, it will need to be reset with a dial indicator as described in the shop manual. Rotate the ring gear one revolution to be sure that nothing is binding.

Your **LOCK-RIGHT** installation should now be complete. As a preliminary test only, prior to the final test on the next page, rotate the tires back and forth (transmission out of gear and drive shaft free). The drivers should randomly unlock and “click” as the tires move. Note that the tires will NOT lock

together—this easy-unlocking characteristic is a unique feature of the **LOCK-RIGHT** and is perfectly normal. Watch to be sure that both sets of teeth engage and disengage. If they do, your installation has probably been done correctly and your **LOCK-RIGHT** is ready for its final test, described in **Section 5** on page 21. Note that the clicking sound is much louder now than what you will hear during driving because the cover is off and no oil is present.

As an additional check to be sure that everything has been installed correctly, use a small ruler, vernier caliper or blade-type feeler gauge. The distance between the halves of the **LOCK-RIGHT**, that is, between the two drivers, should be about 5/32-inch (.152-inch, or 3,86-mm). The tolerance limits are between .145-inch (3,68-mm) and .170-inch (4,32-mm). If this distance is much over .170-inch, either the case is quite worn or the thrust washers are missing or are too thin and the problem should be corrected before proceeding further.

## Vehicle Final Assembly

When everything is correct, clean the axle housing gasket surface and **install the cover** using a gasket and/or sealant as appropriate, and torque the bolts.

Add gear oil. Note that we suggest using medium-to-heavy oils as recommended by the manufacturer, unless the vehicle will be used in very cold weather. Thicker oil, such as 85-140, reduces the “clicking” noise sometimes heard during tight turns and provides adequate lubrication when the assembly becomes hot. Also see the section in the Vehicle Operator’s Manual regarding temperature.

## Section 4: Tire Diameters

To help assure a long life for your new **LOCK-RIGHT, tire diameters should be as nearly equal as possible. DO NOT** change the inflation pressure to vary the rolling radius of the tire! This practice can be dangerous if one of the tires is under-inflated, producing excess heat, faster tire wear and more difficult vehicle control. The best way to equalize the rotation is to measure the circumference of all the tires, including the spare. Choose ones that are within about 3/8-inch or less of each other (do not change from side-to-side if they are radials). If one tire is much more worn than the other one, they both should be replaced for safety reasons.

## Section 5: Testing Your Installation

**1. Be sure that the vehicle is safely blocked.** Leave the axle assembly on the jack stands, with both tires free to rotate and the emergency brake off.

**2. Put the transmission and transfer case in gear** to lock the drive shaft.

**3. Rotate one of the tires** in the forward direction with your hand until it stops, then hold it. That side of the **LOCK-RIGHT** is now locked.

**4. Rotate the other tire** in the opposite (reverse) direction. The **LOCK-RIGHT** should “click” as the coupler attached to the axle rotates.

**5. Rotate the first tire** in the reverse direction and hold it; repeat step 3, rotating the other tire in the forward direction.

**6. Repeat steps 2-4**, rotating and holding the second tire to lock the second side.

## Section 6: Driving Your Vehicle

If the foregoing measurements and tests have been successfully completed, apply the emergency brake and remove the vehicle from the jack stands. Your vehicle should now be ready to drive.

*Carefully read and understand the driving information contained in the **LOCK-RIGHT Vehicle Owner’s Manual!** Safe and effective use of your new **LOCK-RIGHT**-equipped vehicle depends on knowledgeable operation, and this can only be done by understanding its characteristics before you start. Be careful, and have fun!*

## Section 7: Subsequent Disassembly

If something is not correct now or if you need to disassemble your **LOCK-RIGHT** in the future, we will briefly describe the procedure here. We will assume that the case has a thin ring gear and remains in the vehicle, or that it has a thick ring gear and has been removed from the vehicle and is on the bench.

### Non-C-Clip Axles

**1. If the case will remain in the vehicle** (thin ring gear), pull out only the right axle shaft about two inches. Otherwise, remove the differential case from the vehicle and place it in the bench.

**2. Remove the pinion shaft retaining pin** and the pinion shaft.

**3. Rotate the drivers** until one of the right window holes faces out. Push under the spring with a small sharp-pointed pick and pry the end up. Push a small screwdriver or bent

piece of small wire (a paper clip works well) under the spring and pop the bottom out. Push the shear pin out of the pin hole and into the window hole. Repeat for the other three springs and pins.

**4. Position the case horizontally and push in the spacers** so that they are in the middle of the drivers. If a thrust block is used, push it into the right coupler splines.

**5. Remove the driver and spacer opposite the ring gear flange** first and then remove the second driver.

**6. Remove the couplers.**

### C-Clip Axles

**1. Remove the pinion shaft retaining bolt** and the pinion shaft.

**2. Rotate the drivers** until one of the right window holes faces out. Push under the spring with a small sharp-pointed pick and pry the end up. Push a small screwdriver or bent

piece of small wire (a paper clip works well) under the spring and pop the bottom out. Push the pin out of the pin hole and into the window hole. Repeat for the other three springs and pins.

**3. Move the right driver to the *left***, touching the left driver.

**4. Move the right spacer to the left**, into the center of the left driver. (Use the U-shaped wire tool.)

**5. Rotate the left tire** and both drivers until the C-Clip installation recess in the teeth of the right driver is pointing down.

**6. Tap the right tire inward** to release the C-Clip so that it falls down, through the recess.

**7. Rotate the left tire** to rotate both drivers and allow the C-Clip to drop out of the case.

**8. Pull the right tire out** about one inch.

**9. Push the spacers** into the centers of the drivers.

**10. Remove the driver and spacer opposite the ring gear flange** first and then remove the second driver.

**11. Remove the left C-Clip.**

**12. Remove the couplers.**

## Section 8: Technical Assistance

If you have general questions, please contact your local dealer for assistance. If your questions are of a more technical nature, you may call RICHMOND GEAR TechLine: 1-xxx-xxx-xxxx for further information.

## Section 9: Warranty Information

The Warranty is contained in the Vehicle Owner's Manual that is supplied with your new **LOCK-RIGHT**. Consult this manual for complete warranty information.

## IMPORTANT

If your differential case or thrust washers are excessively worn, your new Lock-Right Locker may not be able to operate as it was designed. Therefore, two easy measurements must be made before final assembly to assure that your new locker will function properly. To make these measurements, proceed as follows:

1. Remove the existing spider gears, side gears and thrust washers from the differential case, and thoroughly clean it.
2. Install the Lock-Right couplers with the existing thrust washers in each end of the case.
3. Place the spacers onto the centers of the couplers (wide side toward the axle splines if not symmetrical), and hold them there.
4. Install the pinion shaft; carefully guide it past the spacers as it is being inserted through the holes in the case.
5. Measure the gap between each spacer and the pinion shaft with a feeler gauge. This gap should be between .005-inch and .020-inch, with not more than an .008-inch difference between the two.

*If your numbers are within the limits specified, remove the parts and begin your installation. If your numbers are not within these limits, check the thrust washers and the differential case. If they are excessively worn or are damaged, they may need to be replaced before installing your new Lock-Right Locker.*

***If you have any questions, call PowerTrax Customer Service at 1.864.843.9275 (8AM-6PM ET) for further assistance.***

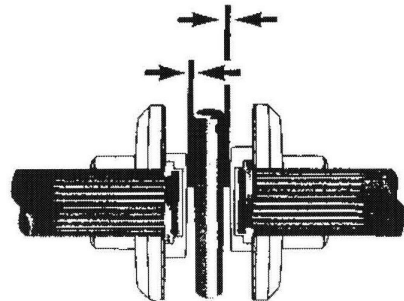



# WARNING!

*The following [WARNING!] and [CAUTION!] information is supplied to you for your protection and to provide you with many years of trouble free and safe operation of your Richmond Gear product.*

Read **ALL** instructions prior to operating transmission and/or ring and pinion. Injury to personnel, transmission or ring and pinion failure may be caused by improper installation, maintenance or operation.

## DANGER!

•It is **dangerous to get under a jacked-up vehicle**. The vehicle could slip off the jack and fall on you. You could be crushed. Never place any part of your body under a vehicle that is on a jack. Never start or run the engine while the vehicle is on a jack. **If you need to get under a raised vehicle, take it to a service center where it can be raised on a lift.**

## WARNING!

•Hot oil can cause severe burns. Use extreme care when removing lubrication plugs and when working close to a unit that has been in operation.

## IMPORTANT INFORMATION

Please Read Carefully

# CAUTION!

- Check lube level between scheduled lube changes to insure that proper lube level is maintained. Inspect vent plug to insure it is clean and operating. Inspect the tightness of mounting bolts, misalignment of connecting shafts, lube leakage, excessive heating, or any unusual noise or vibration.
- Serious personal injury may occur as a result of improperly performed maintenance, adjustments or repairs.
- Do not attempt any of the maintenance, checks or repairs described on the following pages if you are not fully familiar with these or other procedures with respect to the transmission, or are uncertain as to how to proceed. Have the necessary work done by a properly equipped and qualified workshop.
- Always be extremely careful when working on the transmission. Always follow commonly accepted safety practices and general common sense. Never risk personal injury.

(continued on next page)

# CAUTION!

- Do not operate the transmission or ring and pinion without proper lube and correct amount.
- For safe operation and to maintain the unit warranty, when changing a factory installed fastener for any reason, it becomes the responsibility of the person making the change to properly account for fastener grade, thread engagement, load, tightening torque and the means of torque retention.
- Mounting bolts should be periodically checked to ensure that the unit is firmly anchored for proper operation.
- These instructions are not intended to cover all details or variations in equipment, nor provide for every possible contingency to be met in connection with selection, installation, operation, and maintenance. Should further information be desired or should particular problems arise which are not covered sufficiently for the Buyer's purpose, the matter should be referred to Richmond Gear.

In the event of the resale of any of the goods, in whatever form, Resellers/Buyers will include the following language in a conspicuous place and in a conspicuous manner in a written agreement covering such sale:

The manufacturer makes no warranties or representations, express or implied, by operation of law or otherwise, as to the merchantability or fitness for a particular purpose of the goods sold hereunder. Buyer acknowledges that it alone has determined that the goods purchased hereunder will suitably meet the requirements of their intended use. In no event will the manufacturer be liable for consequential, incidental or other damages. Even if the repair or replacement remedy shall be deemed to have failed of its essential purpose under Section 2-719 of the Uniform Commercial code, the manufacturer shall have no liability to Buyer for consequential damages.

Resellers/Buyers agree to also include this entire document including the danger, warnings and cautions above in a conspicuous place and in a conspicuous manner in writing to instruct users on the safe usage of the product.

This information should be read together with all other printed information supplied by Richmond Gear.

**NOTES:**



# Lock-Right Part #MSD (1000-754) Dana 2309, 2310, 2311 and 2312

Welcome to the growing family of LOCK-RIGHT owners! Your new LOCK-RIGHT will give your vehicle *extreme* performance and we trust that you will be pleased with your purchase.

Included in your LOCK-RIGHT kit are two discs. These discs are to be used with non-C-Clip type axles only. If your vehicle has C-Clips, you do not need to install these discs. However, please make sure that the spacers are installed in your unit. the spacers are required in both C-Clip and non-C-Clip type axles, and must be installed for the unit to function correctly.

**RICHMOND**  
**1001 W. Exchange Ave.**  
**Chicago, IL 60609**

## 2310/2311 Addendum Sheet #1000-770

The enclosed locker contains two small washers in addition to the normal Lock Right parts described in the installation manual. They must be used with your locker whether you have a c-clip or a non c-clip differential. If you have a non c-clip differential, then simply assemble the washers onto the spacers using grease to keep them together, and follow the instructions in the installation guide treating the washer/spacer assembly as one piece (Figure 1). If the locker is being installed in a c-clip differential, follow the directions below in addition to the installation guide:

1. Press a washer onto the face of the coupler on the ring side using grease to make it stick.
2. Slide the axle shaft through and place the c-clip in it.
3. Pull the axle out to seat the c-clip on top of the washer.
4. Place a spacer over the end of the axle shaft, covering the c-clip.
5. Assemble the other washer onto the spacer using grease to keep them together, and continue with the instructions in the manual treating the washer/spacer as one piece (Figure 1).
6. When it is time to insert the second c-clip on the axle shaft, push the axle shaft through the coupler, washer/spacer assembly, and driver. The driver has a c-clip slot. Insert a sharp pick into the c-clip slot and separate the washer from the spacer.
7. Seat the washer onto the face of the coupler, line up the c-clip groove on the axle shaft with the slot on the driver and insert the c-clip between the washer and spacer (Figure 2) onto the axle shaft.
8. Slide the spacer over the c-clip and continue with the installation guide.

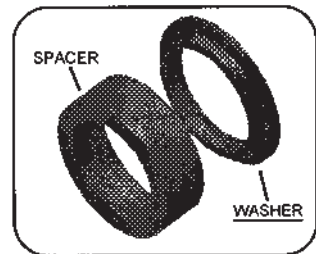

*Figure 1*

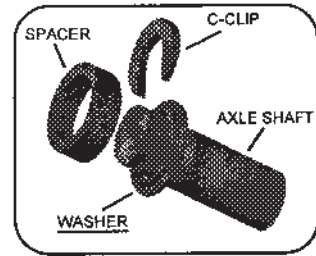

*Figure 2*