



www.skyjacker.com

04-11 GM Colorado / Canyon 2WD / 4WD 4" Suspension Lift Installation Instructions

REQUIRED TOOL LIST:

- * Safety Glasses
- * Metric & Standard Wrenches & Sockets
- * Drill & Assorted Drill Bits
- * Floor Jack
- * Jack Stands
- * Measuring Tape
- * Torque Wrench
- * Transmission Jack
- * Ball Joint Service Kit
- * 3/8" Tap



Before beginning the installation, thoroughly & completely read these instructions & the enclosed driver's WARNING NOTICE. Affix the WARNING decal in the passenger compartment in clear view of all occupants. Please refer to the Parts List to insure that all parts & hardware are received prior to the disassembly of the vehicle. If any parts are found to be missing, contact SKYJACKER® Customer Service at 318-388-0816 to obtain the needed items. If you have any questions or reservations about installing this lift kit, contact SKYJACKER® Technical Assistance at 318-388-0816.

Make sure you park the vehicle on a level concrete or asphalt surface. Many times a vehicle is not level (side-to-side) from the factory & is usually not noticed until a lift kit has been installed, which makes the difference more visible. Using a measuring tape, measure the front & rear (both sides) from the ground up to the center of the fender opening above the axle. Record this information below for future reference.

Driver Side Front: _____

Passenger Side Front: _____

Driver Side Rear: _____

Passenger Side Rear: _____

IMPORTANT NOTES:

- Important! OEM wheels must be replaced. Lift requires wheels with 4.75" Back Spacing.
- Please be aware that some 4 cylinder models with need to modify the sway bar relocation bracket. (re-drill endlink mounting hole)
- This lift is determined from the amount of lift to the front of the vehicle, while only lifting the rear to a position level with the front.
- If larger tires (10% more than the stock diameter) are installed, speedometer recalibration will be necessary. Contact your local GM dealer or an authorized dealer for details.
- After installation a qualified alignment facility is required to align the vehicle to OEM specifications.

Kit Box Breakdown:

CC401 / CC421 / CC409 / CC429:

<u>ITEM#</u>	<u>DESCRIPTION</u>	<u>QTY</u>
CC49L	STEERING KNUCKLE, LEFT	1
CC49R	STEERING KNUCKLE,RIGHT	1
CC42FCM-S	COLORADO,FRONT CROSS-MEMBER	1
CC42RCM-S	4"COLORADO,REAR CROSS-MEMBER	1
CC40DDS-S	4"COLORADO,DRIVER DIFF BRKT	1
CC40DPS-S	4"COLORADO,PASSENGER DIFF BRKT	1
CC40DVS-S	4"COLORADO,DRIVESHAFT SPACER	1
CC40TBD-L	4"COLO,TORSION BRKT, DRIVER	1
CC40TBD-R	4"COLO,TORSION BRKT,PASSENGER	1
CC40RCMB-S	4"COLO,REAR CROSS-MEMBER BUSHING	2
BSE40-S	BUMP STOP, 4" COLORADO	2
FBL48	FRONT BRAKE LINES	1
HB-CC40FCM	HDWR BAG:CC40 FRONT CROSS-MEMBER	1
HB-CC40RCM	HDWR BAG:CC40 REAR CROSS-MEMBER	1
HB-CC40DB	HDWR BAG: CC40 DIFF BRACKETS	1
HB-CC40TBB	HDWR BAG:CC40 TORSION BRACKETS	1
HB-CC40SBLR	HDWR BAG:CC40 SWAY BAR LINKS	1
HB-CC40BSSD	HDWR BAG:CC40 BUMP STOP/KNUCKLES	1
HB-CC40RBLU	HDWR BAG:BRAKE LINE/U-BOLTS	1

Note: 2WD kits will consist of the same parts except for the differential brackets & front driveshaft spacer.

Hardware Bag Breakdown:

HB-CC40FCM

Front Cross Member

<u>ITEM#</u>	<u>DESCRIPTION</u>	<u>QTY</u>
58X512FTB	5/8 X 5 1/2 FINE THREAD BOLT	2
CFXS300-S	FRT CROSS-MEMBER SLEEVE,1"OD,3"LG	2
CC40-WASH	CROSS-MEMBER WASHER	4
58FTN	5/8-18 NYLON INSERT LOCKNUT	2
58SAEW	5/8 SAE WASHERS	4

HB-CC40RCM

Rear Cross Member

<u>ITEM#</u>	<u>DESCRIPTION</u>	<u>QTY</u>
58X4FTB	5/8 X 4 FINE THD BOLT/GR 8	2
CRXS3375-S	COLO REAR XMEM SLEVE,3.375"	2
SP3684	REAR XMEMBER BUSHG,COLORADO	4
58FTN	5/8-18 NYLON INSERT LOCKNUT	2
58SAEW	5/8 SAE WASHERS	4
ZF316	ZERK FITTING ALEMITE, 3/16"	2

HB-CC40DB	Differential Brackets	
<u>ITEM#</u>	<u>DESCRIPTION</u>	<u>QTY</u>
14X50MMB	14MM X 50 METRIC BOLT/ 10.9	4
14X80MMB	14MM X 80 METRIC BOLT/ 10.9	4
14MMN	14MM NYLON INSERT LOCK NUT	4
916SAEW	9/16 SAE WASHERS	12

HB-CC40TBB	Torsion Bar Brackets	
<u>ITEM#</u>	<u>DESCRIPTION</u>	<u>QTY</u>
12X30MMB	12MM X 30 METRIC BOLT/ 10.9	2
12X40MMB	12 X 40 METRIC BOLT/10.9	4
TS250	STEEL SLEEVE .250" LONG	6
12MMN	12 MM NUT (METRIC)	6
12SAEW	1/2 SAE WASHER	12

HB-CC40SBLR	Sway Bar Links	
<u>ITEM#</u>	<u>DESCRIPTION</u>	<u>QTY</u>
CC40SBB-L	4"COLO,SWAY BAR BRKT,DRIVER	1
CC40SBB-R	4"COLO,SWAY BAR BRKT,PASSENER	1
38X1FTB	3/8 X 1 FINE THREAD BOLT	2
38SAEW	3/8 SAE WASHER	4
38FTN	3/8-24 FINE N/I LOCK NUT	2

HB-CC40BSSD	Bump Stops / Steering Knuckles	
<u>ITEM#</u>	<u>DESCRIPTION</u>	<u>QTY</u>
38X4BHB	3/8 X 4 BUTTON HEAD BOLT	2
10X40MMB	10 X 40 METRIC BOLT/10.9	4
5MMX12SHB	5MM X 12MM.80 KNUCKLE BOLTS	4
38HDCC-S	3/8 HEAVY DUTY CABLE CLAMP	4
LT100	NUTS N' BOLTS 427 1 ML TUBE	1

HB-CC40RBLU	Rear Brakeline / U-Bolts	
<u>ITEM#</u>	<u>DESCRIPTION</u>	<u>QTY</u>
8X60MMB	8MM X 60MM BOLT / 10.9	1
TS1125	STEEL SLEEVE 1.125" LONG	1
916FTN	9/16-18 NYLON INSERT LOCKNU	8

HB-CC421	2WD Models Only	
<u>ITEM#</u>	<u>DESCRIPTION</u>	<u>QTY</u>
CC421-TS	1/2" TRANSMISSION SPACER	2
10STVMMN	10MM STOVER NUT	1
5163S-RCC	5/16 X 3 TIE BOLT	2
516TBN	5/16" TIE BOLT NUT	2
WS325-516	WS325 SHIMS, DRILLED 5/16"	2

Front Installation:

1. Park the vehicle on level ground, set the emergency brake, & block the rear tires. Raise the front of vehicle & support the frame rails using jack stands.
2. Remove the torsion bar adjusting bolt using a 27mm socket.
Note: Be sure to measure the installed length of the adjuster bolt before removal. After lift installation, it will be re-installed to this length. (See Photo # 1)
3. Remove the torsion bar from the vehicle. **Note:** Be sure to mark as left & right.
4. Remove the front wheels using a 19mm socket. Disconnect the upper brakeline & ABS retaining clips. (See Photo # 2)
5. Remove the outer tie rod end using a 21mm. (See Photo # 3)
Remove the front shocks using a 18mm & 15mm socket.
6. Remove the brake caliper using a 21mm socket. Wire the caliper out of the way. The brakeline will be removed & replaced later.
7. Remove the sway bar end links using a 15mm socket. (See Photo # 4) **Note:** 2WD models skip to Step # 9.
8. Remove the CV axle retaining nut using a 1 7/16" socket.
9. Disconnect the upper & lower a-arm ball joints from the steering knuckle using a 1 1/16" & 21mm socket. Remove the steering knuckle. (See Photo # 5)
10. Remove the lower a-arm retaining bolts using a 24mm & 18mm socket. (See Photo # 6) Remove the front drive shaft using a 11mm wrench. **Note:** 2WD models skip to Step # 12.
11. Support the front differential using a transmission jack. Disconnect the driver & passenger side of the differential mounts using a 18mm socket. (See Photo # 7) Lower the differential out of the way.
12. To allow for the installation of the Skyjacker kit, the rearward a-arm bushing in the frame must be removed. A new aluminum bushing will be installed. Remove the rearward a-arm frame bushings using a ball joint service kit. (See Photo # 8)

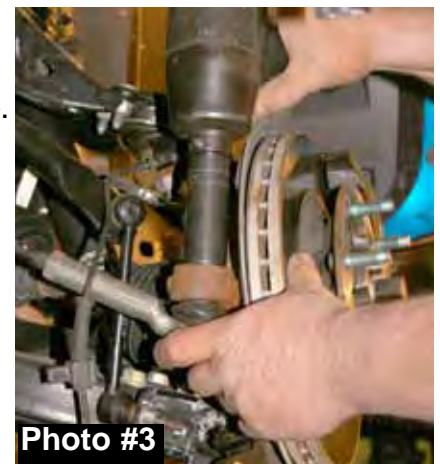

13. Install the new aluminum bushing into the frame. The bushing will install from the front to rear. **Note:** Be sure the bushing is seated flush when installed. (See Photo # 9) **Note:** 2WD models skip to Step # 15.
14. Install the new driver & passenger differential brackets using the 14x50mm bolt & washers. The bolts will thread from the inside of bracket into the frame. (See Photo # 10) Attach the differential to the new brackets using the 14x80mm bolts, washers, & nuts.
15. Install the new front cross member using the 5/8 x 5 1/2" bolts, washers, & nuts. **Note:** Be sure to install the tapered washers between the new cross member & the OEM mount. See Arrows in Photo # 11. Be sure to use the crush sleeve inside the OEM mount.
16. Locate the new rear cross member. Install the new 3/16" zirc fittings into each end of the cross member by tapping in using a 1/4" socket. Grease & install the new bushings & sleeves.
17. Install the new rear cross member using the 5/8 x 4" bolts, washers, & nuts. (See Photo # 12)
18. The inside of the OEM lower a-arms must be ground to allow for clearance of the new cross member. Photo # 13 shows the inside of the a-arm. There are two layers of metal, the lower layer must be ground flush with the upper layer. (See Arrows in Photo # 13). Measure back 4 1/4" & mark the lower layer with a paint pen.
19. With the area marked, grind down the lower layer flush with the upper layer using a grinder. (See Photo # 14) After grinding, check to make sure the a-arm will fit the new cross member.
20. Remove the OEM torsion bar bracket from the rear of the lower a-arm using a 18mm & T55 torx socket. (See Photo # 15)

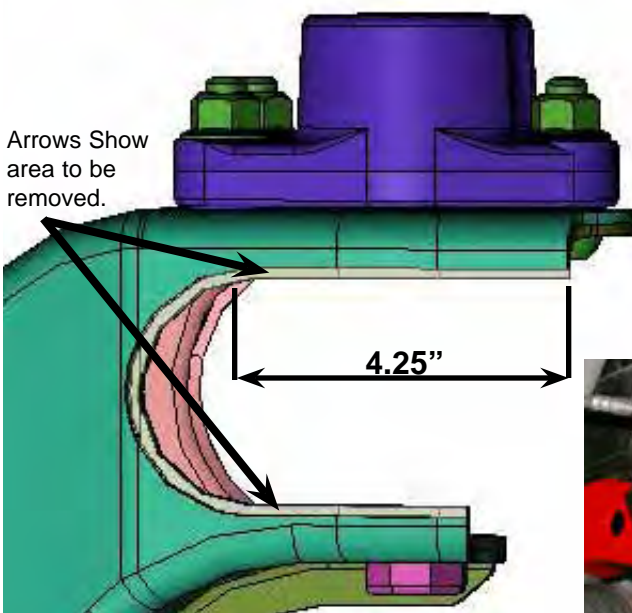
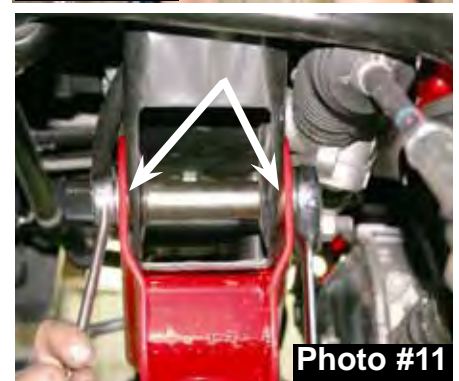

Arrows Show area to be removed.



21. Attach new torsion bar relocation brackets using the 12x40mm bolts in the outer two holes. (See Arrow in Photo # 16) **Note:** Be sure to use one 1/4" thick spacer at each bolt, between the new bracket & the a-arm. In the inward hole, install the 12x30mm bolt with the 1/4" spacer. Install this bolt from the outside in. Do not install the nut at this time. The bolt is only being installed to line up the bracket & 1/4" spacer.
22. Attach the OEM torsion bar mount to the new bracket using the OEM hardware. Before a-arm installation, remove the inner most 12x30mm bolt. (See Arrow in Photo # 17)
23. Attach the lower a-arm to the new front & rear cross member using the OEM bolts. (See Photo # 18)
24. With the a-arm installed, install & tighten the inner 12x30mm bolt on the new torsion bar bracket. (See Photo # 19)
25. Locate the new bump stop extension. Hold the new extension centered against the bottom of the OEM upper bump stop (tapered end up). Raise the a-arm up to the bottom of the bump stop extension. (See Photo # 20) Lower the a-arm down being sure to hold the bump stop extension in place against the a-arm.
26. While holding the bump stop secure to the a-arm. Use a punch to mark the center location for the bolt. (See Photo # 22) With the hole marked, remove the bump stop extension & drill this location using a 5/16" drill bit.
27. Once the hole is drilled, tap using a 3/8"-16 thread pitch tap.
28. Once tapped, install the new bump stop using the 3/8 x 4" button head bolts. Torque to 10 ft. lbs. (See Photo # 23)

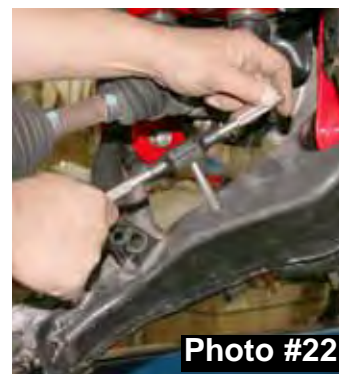
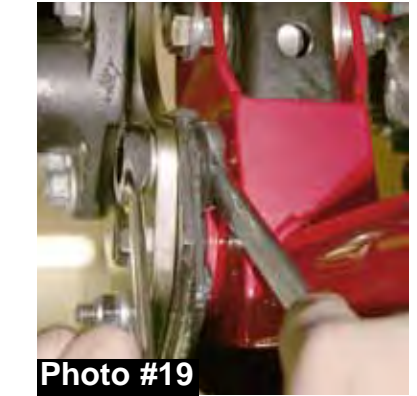

Photo #20

Photo #21

Photo #22

Photo #23

29. Remove the hub bearing assembly from the OEM steering knuckle using a 15mm socket. (See Photo # 24) Remove the ABS line from the OEM knuckle using a 7mm socket.
 30. Attach the hub bearing assembly to the new Skyjacker steering knuckle using the OEM bolts. Be sure to use the supplied loctite on the threads. (See Photo # 25)
 31. Attach the ABS line to the new steering knuckle using the supplied 5x12mm screw & plastic clips provided. (See Photo # 26)
 32. Attach the new steering knuckle assembly to the upper & lower a-arms using the OEM hardware. Reattach the ABS line at the upper a-arm. Remove the OEM brakeline from the frame & caliper.
 33. Install the brake caliper using the OEM hardware. Install the new Skyjacker Stainless Steel Braided line. (See Photo # 27)
 34. Re-Install the CV axle retaining nut, 4wd models only. Install the new front sway bar end link relocation brackets. (See Photo # 28) Remove the inner most forward ball joint retaining bolt from the lower a-arm. Line up the sway bar relocation bracket mounting hole & re-install ball joint bolt. Attach the bracket to the OEM end link location using the 3/8 x 1" fine thread bolt, washers, & nuts. (See Arrow in Photo # 28) Attach the OEM end links to the sway bar & new bracket using the OEM hardware. Re-attach the outer tie rod end & install the front shocks.
- Note:** 2WD models skip to Step # 36.
35. Locate the new aluminum front drive shaft spacer. Install the front driveshaft using the new spacer between the drive shaft & transfer case. (See Arrow in Photo # 29)
 36. Install the torsion bars & set the adjuster bolt back to the OEM length. (See Photo # 30)
 37. Install the front tires & wheels & lower the vehicle to the ground.



Photo #24



Photo #25



Photo #26

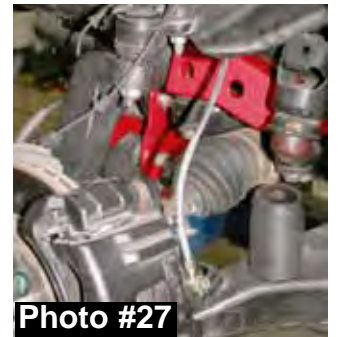

Photo #27

Rear Installation:

37. Raise the rear of the vehicle & properly support the rear frame horns using jack stands. Remove the rear tires & wheels using a 19mm socket.

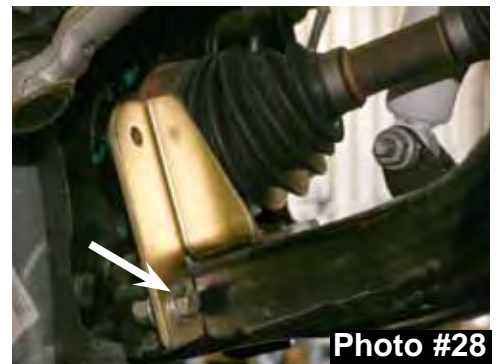

Photo #28



Photo #29



Photo #30

38. Remove the rear shock using a 21mm & 13mm socket. (See Photo # 31)
39. Disconnect the brake line retaining bolt from the differential.
Note: Do not remove the lines from the fitting. (See Photo # 32)
40. Remove the rear u-bolts using a 21mm socket.

Rear Spring Installation: For Rear Add-A-Leafs, see instruction sheet in Add-A-Leaf box.

Note: 2WD Models must install the supplied degree shim with the add-a-leafs or new rear spring. To install, use two large c-clamps to secure the spring leaves together. With the c-clamps tightened, remove the center tie bolt. Install the new degree shim so that the thick end will be towards the front of the vehicle when installed. Insert the new tie bolt & tighten. With the tie bolt secured, remove the spring leaves.

41. Remove the emergency brake cable retaining bolt from the rear leaf spring using a 10mm socket. (Photo # 33)
42. Remove the OEM rear springs using a 21mm socket. Install the new Skyjacker rear springs using the OEM hardware. (See Photo # 34)
43. Install the new rear u-bolts & reattach the brakeline to the new rear springs. Install the new Skyjacker rear shocks. (See Photo # 35)
44. Install the new brakeline spacer block. Secure the OEM T-block using the 8x60mm bolt supplied. (See Photo # 36)
45. Install the wheels & tires & lower the vehicle to the ground.



Photo #31



Photo #32



Photo #34



Photo #35

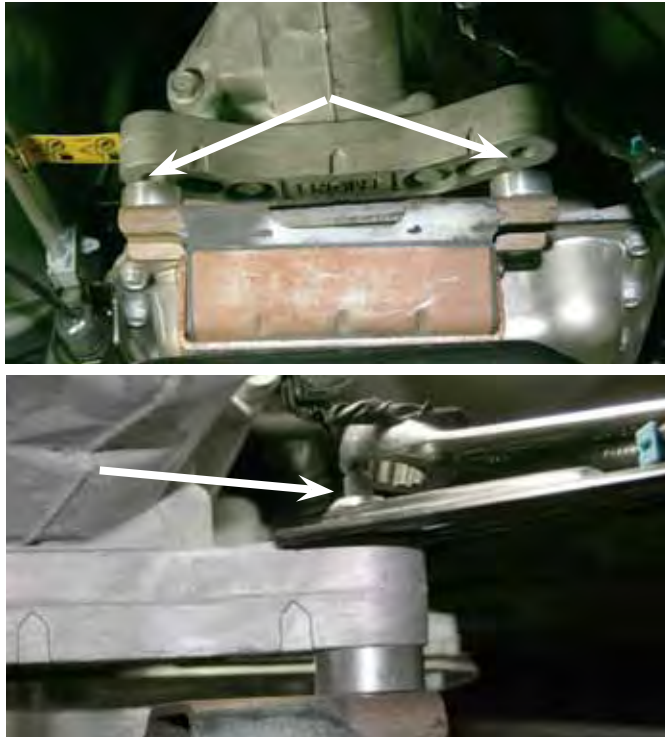

Photo #33



Photo #36

Note: 2WD Models must install the supplied transmission spacers. Using a transmission jack, support the bottom of the transmission. Remove the OEM transmission support bolts. Install the supplied aluminum spacers as shown in the photo below. Use the new 10mm stover nut to secure the O2 sensor bracket as shown.



FINAL NOTES:

- After the installation is complete, double check that all nuts & bolts are tight. Refer to the following chart below for the proper torque specifications. (Do not retighten the nuts & bolts where thread lock compound was used.)
- With the vehicle placed on the ground, cycle the steering lock to lock & inspect the steering, suspension, brake lines, front & rear drivelines, fuel lines, & wiring harnesses for proper operation, tightness, & adequate clearance.
- Have the headlights readjusted to the proper settings.
- Have a qualified alignment center realign the front end to the factory specifications.
- Retorque all the bolts after the first 100 miles.

<u>TORQUE SPECIFICATIONS</u>					
<u>INCH SYSTEM</u>			<u>METRIC SYSTEM</u>		
Bolt Size	Grade 5	Grade 8	Bolt Size	Class 8.8	Class 10.9
5/16	15 FT LB	20 FT LB	6MM	5 FT LB	9 FT LB
3/8	30 FT LB	35 FT LB	8MM	18 FT LB	23 FT LB
7/16	45 FT LB	60 FT LB	10MM	32 FT LB	45 FT LB
1/2	65 FT LB	90 FT LB	12MM	55 FT LB	75 FT LB
9/16	95 FT LB	130 FTLB	14MM	85 FT LB	120 FT LB
5/8	135 FT LB	175 FT LB	16MM	130 FT LB	165 FT LB
3/4	185 FT LB	280 FT LB	18MM	170 FT LB	240 FT LB

- The above specifications are not to be used when the bolt is being installed with a bushing.

Seat Belts Save Lives, Please Wear Your Seat Belt.