



www.skyjacker.com

1997-2006 Jeep TJ Wrangler Rock Ready® 6" Dual Rate Long Travel Coils Long Arm Lift Installation Instructions



Required Tools List:

- **SAE Hex Key & SAE Sockets \ Wrenches**
(5/16" & 5/32" Hex Key Socket & 1/2", 9/16", 3/4"
1-1/8" & 1-13/16")
- **Metric Hex Key & Metric Sockets \ Wrenches**
(13mm, 15mm, 17mm, 18mm, 21mm & 33mm)
- **Star-Shaped T40 & T55 Torx Head Bit**
- **Reciprocating Saw or Similar Cutting Tool**
- **Pipe Wrench**
- **Power Drill**
- **Power Grinder**
- **Hammer**
- **C-Clamp**
- **Wheel Chock**
- **Jack Stands**
- **Paint Marker**
- **Pitman Arm Puller Tool**
- **Drill Bit (3/8", 7/16" & 1/2")**
- **Channel Lock Pliers**
- **Center Punch**
- **Safety Glasses**
- **Floor Jack**
- **Measuring Tape**
- **Torque Wrench**

Before beginning installation, read these instructions & enclosed driver's WARNING NOTICE thoroughly & completely. Also affix WARNING decal in passenger compartment in clear view of all occupants. Please refer to Parts List to insure that all parts & hardware are received prior to disassembly of vehicle. If any parts are found to be missing, contact SKYJACKER® Customer Service at 318-388-0816 to obtain needed items. If you have any questions or reservations about installing this product, contact SKYJACKER® Technical Assistance at 318-388-0816.

Make sure you park vehicle on a level concrete or asphalt surface. Many times a vehicle is not level (side-to-side) from factory, but is usually not noticed until a lift kit has been installed which makes difference more visible. Using a measuring tape, measure front & rear (both sides) from ground up to center of fender opening above axle. Record this information below for future reference.

Driver Side Front: _____ / _____ BEFORE / AFTER	Passenger Side Front: _____ / _____ BEFORE / AFTER
Driver Side Rear: _____ / _____ BEFORE / AFTER	Passenger Side Rear: _____ / _____ BEFORE / AFTER

Important Notes:

- The Drag Link Must Be Adjusted to Center the Steering Wheel Before the Vehicle Is Driven. Failure to Do So Will Cause Computer Errors, Odd Handling Characteristics, & Poor Performance.
- If Larger Tires (10% More Than the OEM Diameter) Are Installed, Speedometer Recalibration Will Be Necessary. Contact Your Local JEEP Dealer or an Authorized Skyjacker® Dealer for Details.
- After Installation, a Qualified Alignment Facility Is Required to Align Vehicle to OEM Specs.
- 6-Speed Transmission Models May Require Additional Modifications. The Options Are Trimming of OEM Console or Bending of OEM Shifter.
- 2003-2006 Models with an Automatic Transmission Must Remove the Front Transmission Skid Plate for Drive Shaft Clearance.
- Rubicon Models Require a CV Yoke (Skyjacker # CVR680) & a Replacement CV Drive Shaft.
- A Slip Yoke Eliminator Kit (Skyjacker # RR231) & a Rear CV Drive Shaft Are Required.
- Exhaust Modifications May Be Necessary.
- Does Not Fit 2004-2006 LJ Unlimited Models.

Component Box Breakdown:**Part # TJ60FDR**

Item #	Description	Qty
TJ60FS-DR	DUAL RATE COIL, FRONT	2

Part # TJ60RDR

Item #	Description	Qty
TJ60RS-DR	DUAL RATE COIL, REAR	2

Part # TJ60RR1

Item #	Description	Qty
RRSP20	STEERING BOX SKID PLATE	1
SBE226	SWAY BAR END LINK, FRONT	1
SBE606	SWAY BAR END LINK, REAR	1
TBA60	ADJUSTABLE TRACK BAR, FRT	1
BP50S	BUMP STOP, TJ	4
BSS3020-S	BUMP STOP SPACER, 2	4
JA750	PITMAN ARM TJ W/POWER STRG	1
TJ68SP	SKID PLATE BRACKETS	1
HB-ABSS252	HDWR BAG: FOR BUMP STOPS	1
I-TJ60RRX1	INSTRUCTION SHEET: TJ60RR1	1

Part # TJ68RRX

Item #	Description	Qty
TJ60DFB-B	SUB-FRAME BRACKET, DR	1
TJ60PFB-B	SUB-FRAME BRACKET, PA	1
JLL2501SX-ASY	LOWER FLEX LINK ARM	4
H-BOX TJ68RRX	HDWR BOX: TJ68RRX	1

Hardware Box Breakdown:**Part # H-BOX TJ68RRX**

Item #	Description	Qty
TJ6VXFURB	FLEX UPPER BRACKET, FRONT	1
TJ6VXRURB	FLEX UPPER BRACKET, REAR	1
TJ60RTB	TRACK BAR BRACKET, REAR	1
FBL44-RBL98	BRAKE LINE SET, FRT & RR	1
TJRSB10	SHOCK RELOC BRACKET, REAR	1
JSRB231A	NP231 TRANSFER CASE SHIFTER	1
TJ68SP	SKID PLATE BRACKETS	1
HB-TJ68RRX	HDWR BAG: TJ68RRX COM BOX	1

Component Breakdown:**Part # TJ60RTB**

Item #	Description	Qty
TJ60RTB-B	TRACK BAR BRACKET, REAR	1
12X70MMB	12 X 70 METRIC BOLT/10.9	1
141509	ES25 SLEEVE, 1.50 LONG	1
12X114FTB	1/2 X 1-1/4 FINE THREAD BOLT	1
516X1FTB	5/16 X 1 FINE THREAD BOLT	1
12MMN	12MM NYLON INSERT LOCK NUT	1
516FTN	5/16 FINE THREAD N/I LOCK NUT	1
12FTN	1/2 FINE THREAD N/I LOCK NUT	1
12SAEW	1/2 SAE WASHER	4
516SAEW	5/16 SAE WASHER	2

Component Breakdown:**Part # RRSP20**

Item #	Description	Qty
RRSP20-S	STEERING BOX SKID PLATE	1
HB-SSP10	HDWR BAG: FOR SSP10	1

Part # SBE226

Item #	Description	Qty
SBE326-L	SWAY BAR END LINK TUBE	2
SBE-E1	SWAY BAR END LINK EYE	4
14X112SPIN	1/4 X 1-1/2 SNAPPER PIN	4
HB-SBENB01	HDWR BAG: FOR SBE226	1

Part # SBE606

Item #	Description	Qty
SBE506-L	SWAY BAR END LINK, REAR	2
HOURGLASS 3/4	SHOCK BUSHING HOURGLASS 3/4	4
142118	ES34 SLEEVE, 1.66 LONG	4

Part # TBA60

Item #	Description	Qty
TBA60-B	TRACK BAR FOR 6" TJ/XJ	1
RE34X34R	ROD END, 3/4 RH THREAD	1
34RFTJN	3/4 RIGHT HAND JAM NUT	1
7400WS	STEERING DAMPER, WHITE	1
BTIE	SHOCK BOOT TIE, RED	1
B10RS	SHOCK BOOT, RED	1
HSS	HYDRO SHOCK DECAL	1
I-TBA10	INSTRUCTIONS FOR TBA10	1
HB-TBA60	HDWR BAG FOR TBA10/60/80	1

Part # TJRSB10

Item #	Description	Qty
JRSRB1-B	SHOCK BRACKET, REAR	2
HB-TJRSB10	HDWR BAG: TJRSB10	1
I-TJRSB10	INST SHEET FOR TJRSB10	1

Part # TJ68SP

Item #	Description	Qty
TJ03SPRDB-1	SKID PLATE, REAR-DRIVER BRKT	1
TJ03SPRPB-2	SKID PLATE, REAR-PASS BRKT	1
HB-TJ68SP	HDWR BAG: SKID PLATE, REAR	1
I-TJ68SP	INSTRUCTION SHEET: TJ68SP	1

Part # JLL2501SX-ASY

Item #	Description	Qty
JLL2501-L	LOWER FLEX LINK ARM	1
RE114-916R	ROD END, 1-1/4 RH /.562 ID	1
114RFTJN	1-1/4 RIGHT HAND JAM NUT	1

Part # JSRB231A

Item #	Description	Qty
TJSRB-1	SHIFT RELOCATE BRKT, TJ MAIN	1
TJSRB-2	SHIFT RELOCATE BRKT, TJ AUX.	1
HB-JSRB231A	HDWR BAG: JSRB231A T/C BRKT	1
I-JSRB231	INST. SHEET FOR JSRB231	1

Component Breakdown:**Part # FBL44**

Item #	Description	Qty
FBL44S	BRAKE LINE, EXTENDED LENGTH	2
3CCW	COPPER CRUSH WASHER, 3/8"	4
BE15	BRAKE LINE EXTENSION	2
HC1	HOSE/HORSESHOE CLIP	2
BTIE	SHOCK BOOT TIE, RED	2
I-BL	INSTRUCTIONS: BRAKE LINES	1

Part # RBL98

Item #	Description	Qty
RBL98S	BRAKE LINE, EXTENDED LENGTH	1
BE15	BRAKE LINE EXTENSION	1
HC1	HOSE/HORSESHOE CLIP	1
I-BL	INSTRUCTIONS: BRAKE LINES	1

Hardware Bag Breakdown:**Part # HB-TJ68RRX**

Item #	Description	Qty
10MMX80MMB	10MM X 80MM METRIC BOLT /10.9	4
10MMN	10MM METRIC N/I LOCK NUT	4
12X30SHB	12MM X 30MM SOCKET HEAD BOLT	2
12X3FSB	1/2 X 3 FLAT SOCKET BOLT	6
12MMX80B	12MM X 80MM METRIC BOLT / 10.9	6
12FTN	1/2 FINE THREAD N/I LOCK NUT	4
12SAEW	1/2 SAE WASHER	8
38SAEW	3/8 SAE WASHER	8
516X1FTB	5/16 X 1 FINE THREAD BOLT	1
516X34TCFB	5/16 X 3/4 THREAD CUTTER BOLT	1
516FTN	5/16" FINE THREAD N/I LOCK NUT	1
516SAEW	5/16 SAE WASHER	1
CCTJ	COIL SPRING CLIP / JEEP TJ	1
12X412FTB	1/2 X 4-1/2 FINE THREAD BOLT	4
12XTFW	1/2" EXTRA THICK FLAT WASHER	8
12X114FTB	1/2 X 1-1/4 FINE THREAD BOLT	1
716X312FTB	7/16 X 3-1/2 FINE THREAD BOLT	4
716FTN	7/16 FINE THREAD N/I LOCK NUT	4
716SAEW	7/16 SAE WASHER	8

Part # HB-JTRSB10

Item #	Description	Qty
12X3FTB	1/2 X 3 FINE THREAD BOLT	4
12FTN	1/2 FINE THREAD N/I LOCK NUT	4
12SAEW	1/2 SAE WASHER	8
12XTFW	1/2 EXTRA THICK FLAT WASHER	4
142121	ES24 SLEEVE \402087 1.38	2
38X1FTB	3/8 X 1 FINE THREAD BOLT	2
38FTN	3/8 FINE THREAD N/I LOCK NUT	2
38SAEW	3/8 SAE WASHER	4

Part # HB-ABSS252

Item #	Description	Qty
38X234FTB	3/8 X 2-3/4 FINE THREAD BOLT	4
38FTN	3/8 FINE THREAD N/I LOCK NUT	4
38SAEW	3/8 SAE WASHER	4

Hardware Bag Breakdown:**Part # HB-TJ68SP**

Item #	Description	Qty
38X114FTB	3/8 X 1-1/4 FINE THREAD BOLT	2
38FTN	3/8-24 FINE THREAD N/I LOCK NUT	2
38SAEW	3/8 SAE WASHER	4

Part # HB-JSRB231A

Item #	Description	Qty
516X1FTB	5/16 X 1 FINE THREAD BOLT	2
516FTN	5/16" FINE THREAD N/I LOCK NUT	2
516SAEW	5/16 SAE WASHER	2
38FSFTN	3/8-24 FLANGE SERRATED NUT	2
FSB3838	FLANGED SLV BRG 3/8 X 3/8	2
SS1062-UL	JSRB SLEEVE, 1.062 1.052 LONG	1
SS312-UL	JSRB SLEEVE, .312 .302 LONG	1
TS38	EXT. TUBE, 3.25 FOR JSRB KIT	1

Part # HB-SSP10

Item #	Description	Qty
12SAEW	1/2 SAE WASHER	2
38FTN	3/8 FINE THREAD N/I LOCK NUT	1
38SAEW	3/8 SAE WASHER	1
38X2FTB	3/8 X 2 FINE THREAD BOLT	1
516X34TCFB	5/16 X 3/4 THREAD CUTTER BOLT	1
58SP	5/8 SPACER	1

Part # HB-SBENB01

Item #	Description	Qty
SBB2	SWAY BAR U-BRACKET FOR SBE	2
141509	ES25 SLEEVE \403646 1.50	4
12X212CTBG5	1/2 X 2-1/2 COARSE THREAD BOLT	2
10X35MMB	10MM X 35MM METRIC BOLT / 10.9	2
12CTCLN	1/2" COARSE CENTER LOCK NUT	2
10MMN	10MM METRIC N/I LOCK NUT	2
38SAEW	3/8 SAE WASHER	2
12SAEW	1/2 SAE WASHER	2

Part # HB-TBA60

Item #	Description	Qty
TJDLB	TJ DRAG LINK BUSHING, 1.125	2
12X212FSB	1/2 X 2-1/2 FLAT SOCKET BOLT	1
12X312FTB	1/2 X 3-1/2 FINE THREAD BOLT	1
12USSW	1/2 USS WASHER	1
12SAEW	1/2 SAE WASHER	1
12STVFTN	1/2" STOVER LOCK NUT, FINE THD	1
2888	BUSHING JEEP TRACK BAR	2
142121	ES24 SLEEVE 402087 1.38 LONG	1
81004	TAPERED SLEEVE, 1/2 I.D.	1
LT100	NUTS N' BOLTS 427 1 ML TUBE	1
HOURLASS 5/8	HOURLASS SHOCK BUSHING	2
P837	STABILIZER TAPERED STUD	1
140629	EB6 STUD BAG - P932/140629	1
7146-B	TJ TRACK BAR/STABILIZER BRKT	1
12STVCTN	1/2" STOVER COARSE, LOCK NUT	1

Pre-Installation Tips:

'SET' the Length of the Rock Ready® Flex Link Arm Assemblies.

Skyjacker # JLL2501SX-ASY (JLL2501-L Lower Flex Link Arm with # RE114-916R Right Hand 1-1/4" Rod End & # 114RFTJN Jam Nut). (See Photo # 1)

Measure length of Skyjacker Flex Link Arm assembly from centerline of rod end to centerline of bushing. **Note:** Be sure to keep ends square with each other.

Note: These are pre-alignment measurements only. Final Measurements are to be set by a qualified alignment facility.

Skyjacker Flex Link
centerline-to-centerline
Measurement for 6" Lift.
Lower Front = 29-1/4"
Lower Rear = 29-1/4"

On the rod end, rotate the jam nut against the steel tubing. Hold the rod end in place with a pipe wrench & use another pipe wrench or 1-13/16" wrench on the jam nut to completely tighten.
(See Photo # 2 & # 3)

Tech Note: The jam nut must be tightened against the steel tubing before installation.

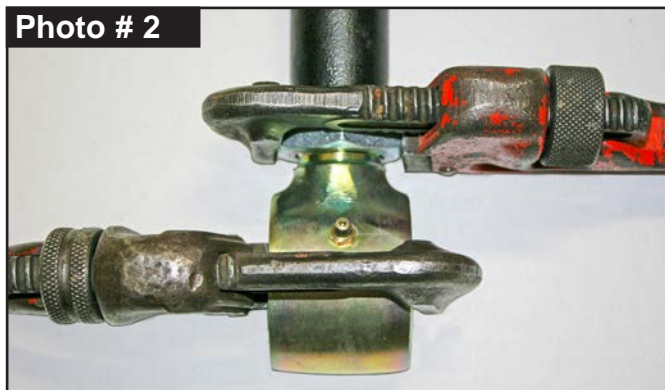

Front Installation: **Note:** Save all factory components & hardware for reuse, unless noted.

1. With vehicle on flat level ground, set emergency brake & chock rear tires \ wheels.
2. From inside the engine compartment, disconnect both OEM front shock upper stud mounts using a 15mm socket \ wrench.
3. Raise front of vehicle, support frame rails using jack stands at indicated lift points in OEM service manual.
4. Remove the front tires \ wheels using a 3/4" or 18mm socket.
5. Place a floor jack underneath front axle for support. Disconnect OEM front shock lower mount using a 13mm socket \ wrench. Retain factory lower mounting hardware for re-use.
6. Remove OEM steering stabilizer using a 15mm socket \ wrench.

7. Disconnect OEM front track bar from lower passenger side axle mount using a 15mm socket \ wrench or a T55 Torx head bit. (See Photo # 4)
8. Disconnect OEM drag link assembly from OEM pitman arm. Use a pitman arm puller tool to detach drag link from pitman arm. Take caution not to tear the drag link grease boot.
Mark the position of OEM pitman arm on steering gear box. Remove OEM nut & washer from steering gear box using a 33mm socket \ wrench. Align & install Skyjacker # JA750 Pitman Arm on OEM steering gear shaft. Install with OEM washer & nut. Tighten using 33mm socket \ wrench. Torque 185 ft-lbs.
9. Disconnect OEM sway bar end links from axle brackets using a 18mm socket \wrench & a T55 Torx head bit. (See Photo # 5)
10. Disconnect OEM brake line bracket from frame using a T40 Torx socket. (See Photo # 6)

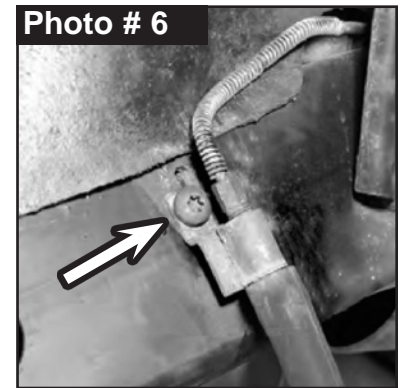
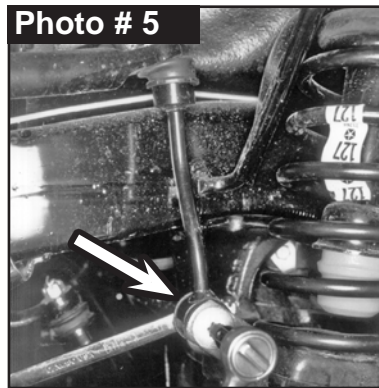
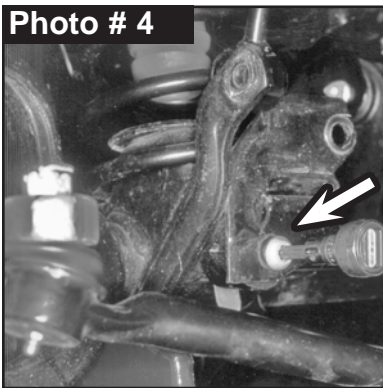

11. Remove two (2) brake caliper mounting bolts & remove brake caliper from OEM knuckle using a 21mm socket \wrench.
Tech Note: Hang brake caliper on frame out of way using a hook or bungee. **Do Not** hang by rubber brake line.

12. Support front axle with a floor jack. While checking for appropriate slack in ABS lines, brake lines, differential vent hose & etc, lower the front differential until the OEM front coil springs become loose. Remove OEM bottom bolt & clip from driver side OEM coil spring using a 13mm socket \wrench. (See Photo # 7)

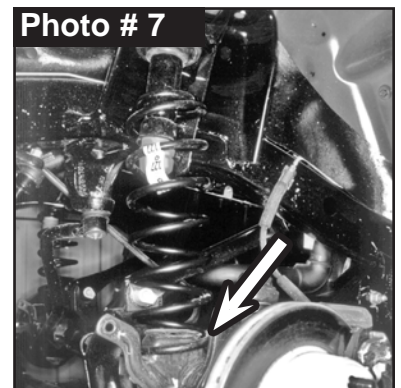

Remove OEM coil spring. **Tech Note:** If front axle cannot be lowered enough to allow coil spring to be installed, carefully rotate the pinion up to provide more clearance.

13. Remove OEM upper bump stop. **Tech Note:** Use channel lock pliers working OEM bump stop back & forth to remove.

Install Skyjacker #BP50S Bump Stop into OEM bump stop cup. **Tech Note:** A silicon spray or lubricant will help installation.

14. Drill a 3/8" hole in the center indent of the lower coil seat. (See Photo # 8)



Install Skyjacker # BSS3020-S Bump Stop Spacer (round) polymer bump stop spacer.

Insert supplied 3/8 X 2-3/4 Fine Thread Bolt with 3/8" SAE Washer into bump stop. Align bolt into hole of OEM lower coil spring mount pad. Reach under spring mount pad & above axle tube to install supplied 3/8" Nylon Insert Lock Nut onto bolt. Tighten bump stop into place using a 9/16" socket \ wrench. (See Photo # 9) Torque 25 ft.-lbs.



15. Remove OEM lower link arm using a 21mm socket \ wrench.
Note: If equipped with ABS brakes, remove ABS sensor wire / clamp from the inside of the lower arms.

16. Using care, grind off OEM front lower link arm mount. File smooth any burrs or sharp edges on OEM frame, then paint or undercoat all exposed metal surface areas. (See Photo # 10)

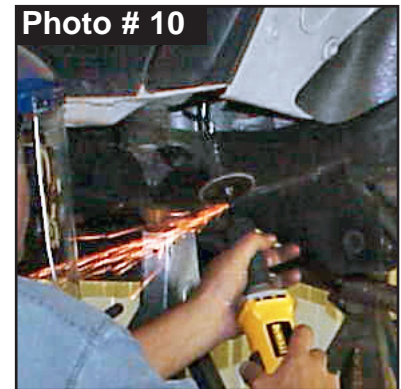

17. Place a jack under OEM transfer case crossmember \ skid plate.
 Remove six (6) OEM bolts of the transfer case crossmember \ skid plate: three (3) on each frame rail. (See Photo # 11)
 1997-2002: Use 3/4" socket \ wrench.
 2003-2006: Use a 18mm socket \ wrench.
 Lower skid plate down.



18. **CAUTION: 2003-2006 TJ Models** Will Require Modification to OEM Skid Plate in order to Install the Skyjacker Sub-Frame. (See Page 16)

Place the Skyjacker # TJ60DFB-B Driver Side & # TJ60PFB-B Passenger Side Sub-Frames between the bottom of the frame & skid plate. **Tech Note:** On some models, it may be necessary to grind down OEM rear step bar nut insert on the outside of the frame to allow the sub-frame rail to mount flush.

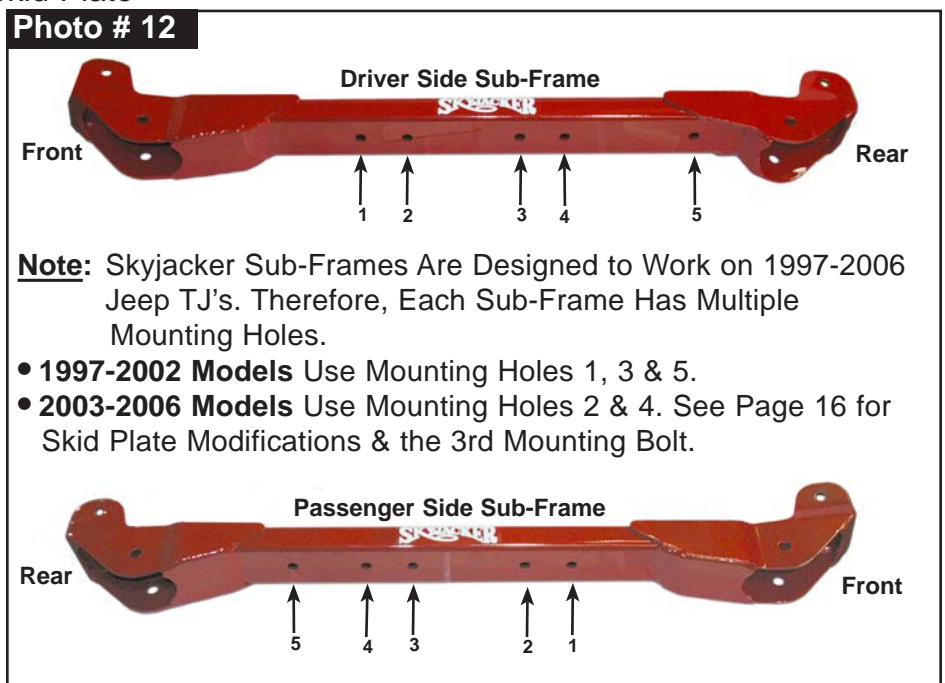

1997-2002 TJ Models Note: Apply a few drops of supplied # LT100 Thread Lock Compound onto supplied 1/2" x 3" Flat Socket Tapered Head Bolts. Tighten using a 5/16" hex head socket. (See Photo # 12) Secure, but **Do Not Completely Tighten** until all six (6) are installed. Torque 90 ft-lbs.

2003-2006 TJ Models Note: Apply a few drops of supplied # LT100 Thread Lock Compound onto supplied 12mm x 80mm Metric Bolts. Install with 1/2 SAE Washer on bolt & tighten using a 18mm socket \ wrench. (See Photo # 12) Secure, but **Do Not Completely Tighten** until all six (6) are installed. Torque 75 ft-lbs.

19. With the Skyjacker sub-frames attached, use the Skyjacker bracket hole as a guide.

Mark, center punch & drill a pilot hole.

Drill out pilot hole using a 1/2" drill bit. (See Photo # 13)

Center punch through drilled hole. Drill completely through the frame & the mounting tab located on the back side of the sub-frame using a 1/2" drill bit. **Tech Note:** Keep drill as straight & square to bracket as possible.

Install supplied 1/2" x 4-1/2" Fine Thread Bolt with 1/2" SAE Washer on outside & 1/2" SAE Washer with 1/2" Nylon Insert Lock Nut inside using a 3/4" socket \ wrench. Secure, but **Do Not Completely Tighten**. To set bushings properly for ride height, these will be tightened once vehicle is on ground with full vehicle weight on tires \ wheels.

20. Install Skyjacker # JLL2501SX-ASY Lower Link Arm with OEM hardware using a 21mm socket \ wrench. (See Photo # 14) **Note:** Install with rod end at OEM lower axle mount & bushing end to upper sub-frame mount.

21. One at a time, remove OEM upper link arm using a 21mm socket \ wrench. (See Photo # 15)

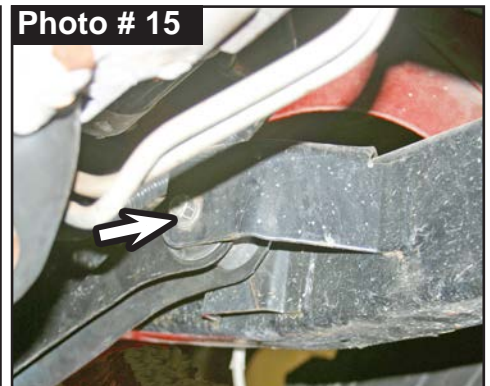
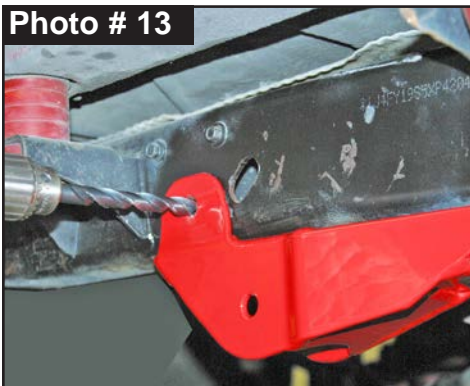

22. Install Skyjacker Front Upper Link Arm Relocation Bracket (# TJ6VXFDRB-B Driver Side & # TJ6VXFPRB-B Passenger Side). Attach bracket into OEM link arm upper mount with OEM hardware using a 21mm socket \ wrench. (See Photo # 16) Secure, but **Do Not Completely Tighten**. To set bushings properly for ride height, these will be tightened once full vehicle weight vehicle is on the ground.

Important Note: Exhaust modifications may be necessary to allow for articulation & clearance of Skyjacker Upper Link Arm Relocation Brackets. On some models, the cross over pipe will need to be shortened so that it does not run under the link arm & Skyjacker bracket.

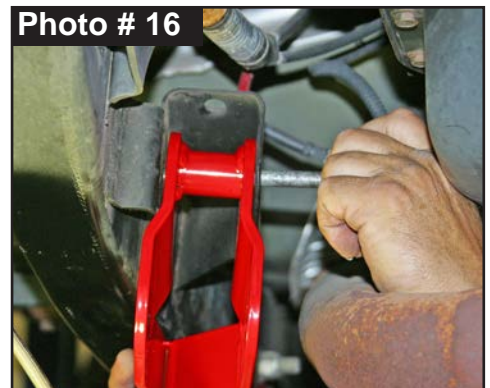

23. Measure from the edge of the upper arm access hole 7-1/8" toward the rear of the vehicle. Measure from the bottom of the frame up 3/4". Make marks where both of the measurements align. Center punch to be drilled. (See Photo # 17 & # 18)

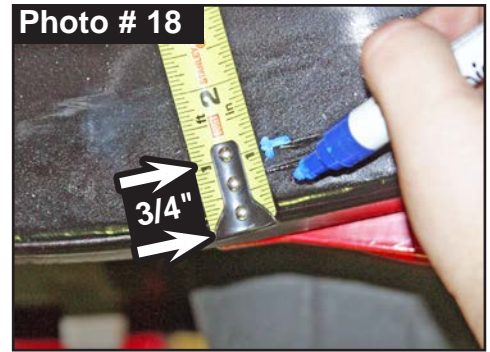

24. Using a square, align Skyjacker bracket with the bottom of the frame. (See Photo # 19)
Clamp into place with C-Clamp. (See Photo # 20)

Drill a pilot hole at center punch mark. Drill out pilot hole thru the frame & Skyjacker bracket using a 7/16" drill bit. (See Photo # 20)

25. Install with supplied 7/16" x 3-1/2" Fine Thread Bolt with 7/16" SAE Washer outside & 7/16" SAE Washer with 7/16" Nylon Insert Lock Nut inside using a 9/16" socket \ wrench. (See Photo # 21)

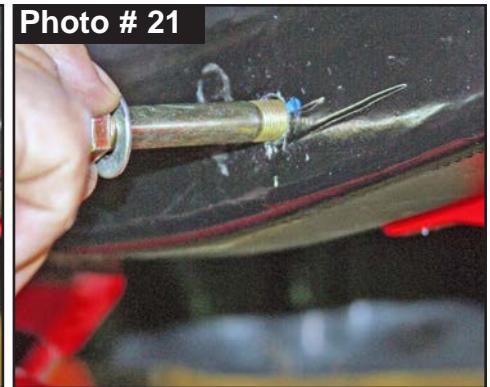

26. Install OEM upper link arm into Skyjacker Upper Link Arm Relocation Bracket with supplied 10mm x 80mm Bolt with 3/8" SAE Washer outside & 3/8" SAE Washer with 10mm Nylon Insert Lock Nut inside using a 15mm socket \ wrench. Tighten all bolts at this time.

27. Attach OEM upper link arm to axle mount with OEM hardware using a 21mm socket \ wrench.

28. Locate Skyjacker # JSRB231A Transfer Case Shifter Bracket & hardware bag. Install now per separate instructions.

29. Lower the front differential. Install Skyjacker coil spring placing the top of the coil spring over the upper bump stop mount first. Be sure that the coil & OEM spring isolator are indexed to seat properly, then raise axle enough to hold coil spring in place.

Re-install OEM bottom clip & bolt to driver side over Skyjacker coil spring using a 13mm socket \ wrench. Torque 20 ft.-lbs.

Note: OEM provides a hole mount on the passenger side lower coil spring mount for you to fasten the coil spring securely to its seat.

Locate Skyjacker # CCTJ Coil Spring Clip. (See Photo # 22) Install Coil Spring Clip to passenger side with supplied 5/16" x 3/4" Thread Cutter Flange Bolt using a 1/2" socket \ wrench. Install the same as on the driver side. Torque 180 in-lbs.



30. Locate Skyjacker # TBA60-B Adjustable Track Bar. Locate # HB-TBA60 Hardware Bag. Coat the two (2) # 2888 Poly Bushing halves & one (1) # ES24 1.38 Long Steel Sleeve with a water resistant grease. Press bushings & sleeve into upper track bar mount.

Insert the bushing end of the Skyjacker track bar into the OEM Steering Stabilizer location on the passenger side of the axle (Not OEM track bar location).

Attach Skyjacker # 7146-B Steering Stabilizer Mounting Bracket with the tab over the OEM sway bar end link stud with the OEM nut.

Attach Skyjacker track bar to mounting bracket with supplied 1/2" x 2-1/2" Flat Socket Head Bolt & 1/2" Stover Nut using a 5/32" Hex Key Socket & 3/4" socket \wrench. (See Photo # 23)

Note: In extreme situations (depending on pinion angle & caster settings), the drag link may contact the Skyjacker Steering Stabilizer Mounting Bracket when turning. This bracket can be slightly ground for additional clearance, if needed.



31. From # HB-TBA60 Hardware Bag, install Skyjacker Track Bar rod end by following the hardware pictured. (See Photos # 24 & # 25) Being sure to keep the rod end square (parallel) with the frame mount.

On the rod end, rotate the jam nut against the steel tubing. Hold the rod end in place with a pipe wrench & use another pipe wrench or 1-1/8" wrench on the jam nut to completely tighten.

Tech Note: The jam nut must be tightened against the steel tubing before installation.

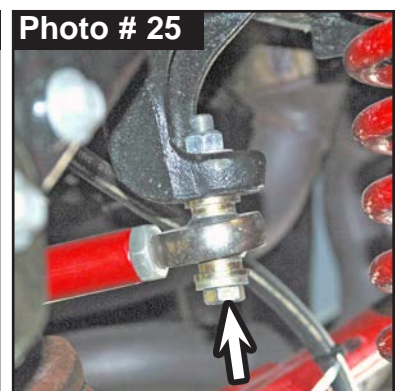

32. Locate Skyjacker # P837 Tapered Stud & # 140629 EB6 Stud Hardware.

Install Skyjacker # P837 Tapered Stud into upper mounting hole on the Skyjacker Track Bar Bracket through OEM drag link mounting hole. Attach with stud hardware.

Coat the two (2) # Hourglass 5/8 Bushings with a water resistant grease. Press bushings into the Skyjacker Steering Stabilizer eyes. Attach to Skyjacker Stabilizer bracket stud & OEM stud mount. (See Photo # 26)



33. Apply a few drops of supplied # LT100 Thread Lock Compound onto the two (2) brake caliper OEM mounting bolts. Attach brake caliper to OEM knuckle using a 21mm socket \wrench.

34. Locate Skyjacker # FBL44 Front Brake Lines. Install now per separate instructions.

NOTE: If installing HYDRO, NITRO, Black MAX, or M95 Monotube Shocks: Proceed to Step 35. If installing ADX 2.0 Remote Reservoir Shocks: Proceed to Step 36.

35. Install Skyjacker front shock at upper shock tower mount with supplied stud bushings, cup washers & nut using a 15mm socket \wrench.

Connect Skyjacker shock at lower axle mount with OEM hardware using a 13mm socket \wrench. Secure, but **Do Not Completely Tighten**. To set bushings properly for ride height, these will be tightened once vehicle is on ground with full vehicle weight on tires \wheels.

36. Install Skyjacker ADX front shock. **Tech Note:** ADX Remote Reservoir are to be mounted with the remote reservoir toward rear for proper clearance (opposite side of coil spring mount). (See Photo # 27 & # 28)

Loosely assemble two (2) supplied reservoir clamps with two (2) supplied hex head bolts using a 5/32" Hex Key socket. Position clamp into place around shock & reservoir cylinder. Secure, but **Do Not Completely Tighten.**

Install Skyjacker ADX front shock at upper shock tower mount with supplied stud bushings, cup washers & nut using a 15mm socket \ wrench.

Connect Skyjacker shock at lower axle mount with OEM hardware using a 18mm socket \ wrench. Secure, but **Do Not Completely Tighten** at this time. These will be tightened once vehicle is on ground with full vehicle weight on tires \ wheels.

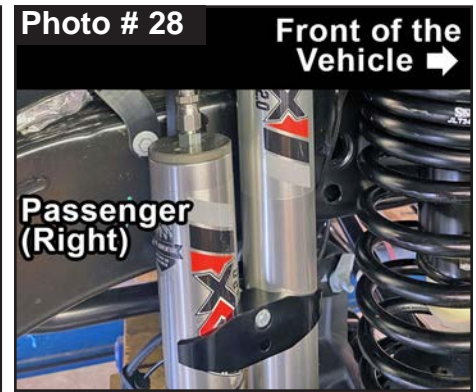
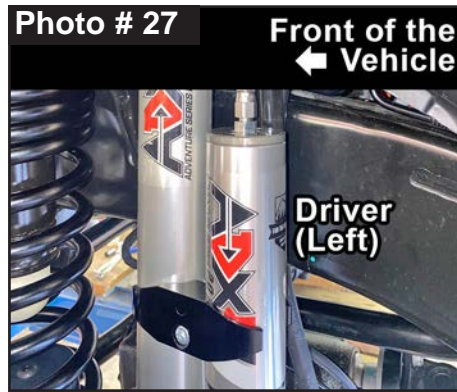

37. Connect OEM drag link to Skyjacker Pitman Arm using OEM hardware. Torque 55 ft.-lbs. **Note:** Always tighten, never loosen castellated nut to align cotter pin hole.
38. Connect OEM brake line bracket to frame with OEM bolt using a T40 Torx socket. (See Photo # 6)
39. Locate Skyjacker # SBE226 Front Sway Bar Double Disconnect End Links. Coat # ES25 1.50 Long Steel Sleeves with a water resistant grease & press into upper & lower end links mounts. **Note:** Sway Bar End Links are to be installed with offset inward as shown. (See Photo # 29)
- Install Skyjacker # SBB2 Sway Bar End Link U-Bracket to bottom of OEM sway bar. Connect with 10mm x 35mm Bolt up through u-bracket & sway bar with 3/8" SAE Washer & 10mm Nut on top. Tighten using a 15mm socket \ wrench. (See Photo # 30)
- Install upper end link mount into Skyjacker U-Bracket. Connect with supplied 1/2" x 2-1/2 Bolt with 1/2" SAE Washer from frame side out to provide adequate clearance. Attach 1/2" Center Lock Nut with 1/2" SAE Washer on outside using a 3/4" socket \ wrench. (See Photo # 30)
- Attach lower end link to axle mount with OEM hardware using a 18mm socket \ wrench & a T55 Torx head bit. Passenger side goes in between OEM mount & Steering Stabilizer Mounting Bracket. (See Photo # 31) Secure, but **Do Not Completely Tighten** at this time.

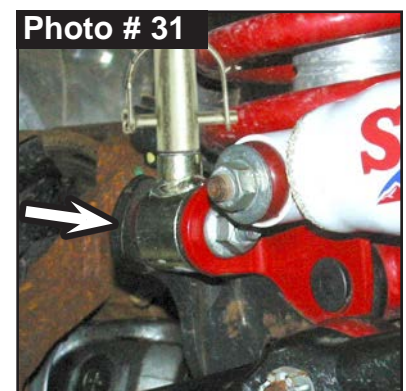
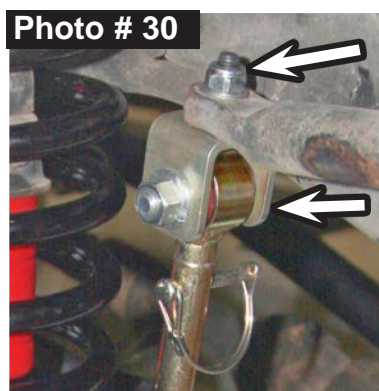
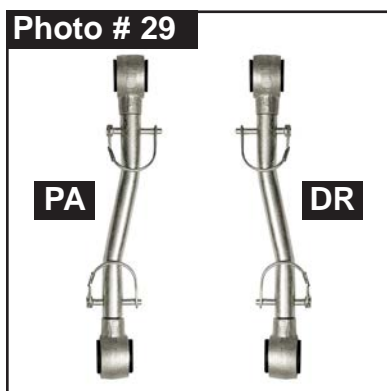

40. Install the front tires \ wheels using a 3/4" or 18mm socket & lower the vehicle to the ground.
41. Locate Skyjacker # RRSP20 Steering Box Skid Plate. Install now per separate instructions.

REAR Installation:

Note: Save all factory components and hardware for reuse, unless noted.

1. Chock front tires \ wheels. Raise rear of vehicle & support frame rails using jack stands at indicated lift points in OEM service manual.
2. Remove the rear tires \ wheels using a 3/4" or 18mm socket.
3. Remove OEM rear shocks. Disconnect upper mount bar pin using a 13mm socket \ wrench. Disconnect lower axle mount using a 18mm & a 15mm socket \ wrench.
4. Disconnect OEM rear track bar at axle mount using a using a T55 Torx bit.
5. Disconnect OEM rear sway bar end links using a 18mm & a 15mm socket \ wrench.
6. Support rear axle with a floor jack. Disconnect rear emergency brake cables. While checking for appropriate slack in ABS lines, brake lines, differential vent hose & etc, lower the rear axle until the OEM rear coil springs become loose. Remove OEM coil spring.
7. Remove OEM upper bump stop. **Tech Note:** Use channel lock pliers working OEM bump stop back & forth to remove.

Install Skyjacker #BP50S Bump Stop into OEM bump stop cup. **Tech Note:** A silicon spray or lubricant will help installation.

8. Drill a 3/8" hole in the center indent of the lower coil seat.
Install Skyjacker # BSS3020-S Bump Stop Spacer (round) polymer bump stop spacer.

Insert supplied 3/8 X 2-3/4 Fine Thread Bolt with 3/8" SAE Washer into bump stop. Align bolt into hole of OEM lower coil spring mount pad. Reach under spring mount pad & above axle tube to install supplied 3/8" Nylon Insert Lock Nut onto bolt. Tighten bump stop into place using a 9/16" socket \ wrench. (See Photo # 32) Torque 25 ft.-lbs.



9. Install Skyjacker # TJ60RTB-B Rear Lower Track Bar Bracket over OEM rear lower track bar bracket at axle.

With Skyjacker bracket seated flush, insert supplied 12mm x 70mm Bolt with 1/2" SAE Washer from rear-to-front through bottom hole of bracket \ axle mount. Place # 141509 Crush Sleeve inside OEM mount & insert bolt through bracket \ axle mount. Attach with 12mm Nylon Insert Lock Nut using a 18mm socket \ wrench. (See Photo # 33) Tighten.

With bracket \ axle mount tightly in place, use the Skyjacker bracket hole as a guide & mark / center punch the OEM bracket. (See Photo # 34)

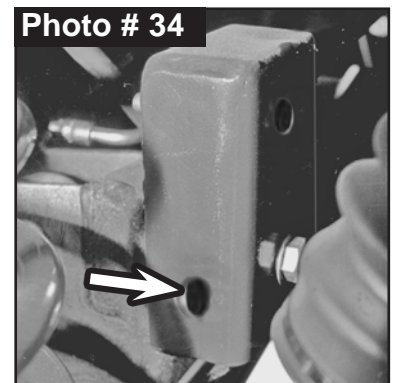
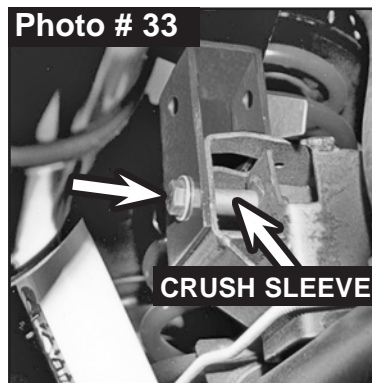

10. Remove Skyjacker bracket & supplied hardware. Drill axle mount using a 1/2" drill bit.

Re-install Skyjacker bracket. Insert supplied 1/2" x 1-1/4" Fine Thread Bolt with 1/2" SAE

Washer through bracket \ axle mount at drilled hole. Attach with 1/2" SAE Washer & 1/2" Nylon Insert Lock Nut using a 3/4" socket \ wrench. (See Photo # 35) Torque 60 ft.-lbs.

Install supplied 5/16" x 1" Fine Thread Bolt with 5/16" SAE Washer into forward hole of bracket. Attach with 5/16" SAE Washer with 5/16" Nylon Insert Nut using a 1/2" socket \ wrench. Torque 180 in-lbs.

Re-install supplied hardware for bracket \ axle mount as stated before & tighten all mounting hardware. 1/2" Bolt Torque 65 ft.-lbs. 12mm Bolt Torque 75 ft.-lbs.

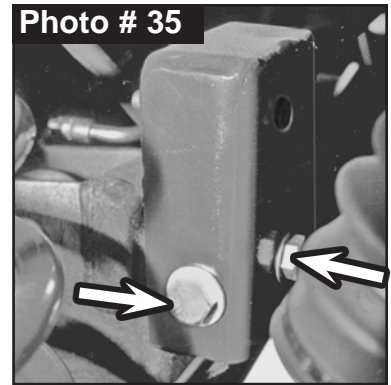

11. Install Skyjacker rear coil spring. Be sure coil spring is seated properly at lower axle mount by rotating the coil until the pigtail hits the spring stop. **Note:** Be sure OEM upper coil spring isolator is properly aligned with coil & upper coil spring mount.

Raise rear axle to load Skyjacker rear coil springs.

12. One side at a time, remove OEM rear lower link arm using a 21mm socket \ wrench.

13. Using care, grind off OEM rear lower link arm mounts. File smooth any burrs or sharp edges on OEM frame, then paint or undercoat all exposed metal surface areas. **Note:** This is the same process as the front lower link arm bracket.

14. One at a time, install Skyjacker # JLL2501SX-ASY Rear Lower Link Arm with OEM hardware using a 21mm socket \ wrench. **Note:** Install with rod end at OEM lower axle mount & bushing end to upper sub-frame mount. (See Photo # 36) Secure, but **Do Not Completely Tighten**. To set bushings properly for ride height, these will be tightened once full vehicle weight vehicle is on the ground.

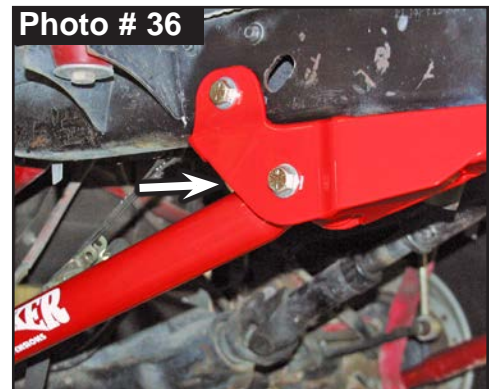

2003-2006 TJ Models Note: Remember to run bolt through Skyjacker Skid Plate Rear Mounting Brackets. (See Page 16)

15. One at a time, remove OEM upper link arm using a 21mm socket \ wrench.

One at a time, install Skyjacker Rear Upper Link Arm Relocation Bracket (# TJ6VXRDRB-B Driver Side & # TJ6VXRPRB-B Passenger Side). **Note:** Same process as the front upper link arm bracket.

Attach bracket into OEM link arm upper mount with OEM hardware using a 21mm socket \ wrench. (See Photo # 37) Secure, but **Do Not Completely Tighten**.



16. Measure from the edge of the upper arm access hole 8-1/2" toward the rear of the vehicle. Measure from the bottom of the frame up 1". Make marks where both of the measurements align. Center punch to be drilled. (See Photo # 38 & # 39)



17. Using a square, align Skyjacker bracket with the bottom of the frame.
Clamp into place with C-Clamp. (See Photo # 40)
Drill a pilot hole at center punch mark. Drill out pilot hole thru the frame & Skyjacker bracket using a 7/16" drill bit.
18. Install with supplied 7/16" x 3-1/2" Fine Thread Bolt with 7/16" SAE Washer outside & 7/16" SAE Washer with 7/16" Nylon Insert Lock Nut inside using a 9/16" socket \ wrench. (See Photo # 41)
19. Install OEM upper link arm into Skyjacker Upper Link Arm Relocation Bracket. **Note:** This bracket features two (2) mounting locations for the upper link arm. If installing a Skyjacker 6" lift, use the forward hole in the bracket or the rearward hole for 8" lifts. (See Photo # 42)
Install with supplied 10mm x 80mm Bolt with 3/8" SAE Washer outside & 3/8" SAE Washer with 10mm Nylon Insert Lock Nut inside using a 15mm socket \ wrench. Secure, but **Do Not Completely Tighten**.

Photo # 40

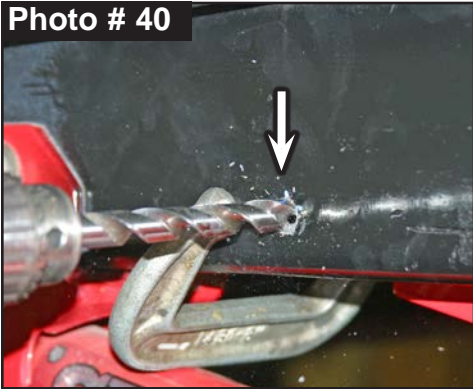

Photo # 41

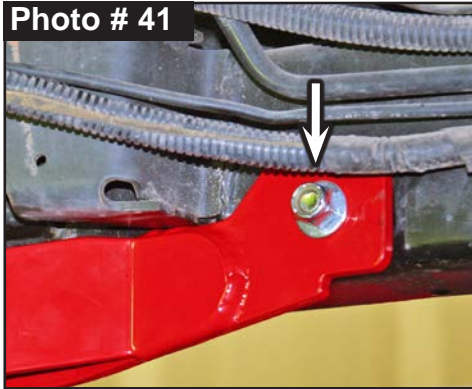
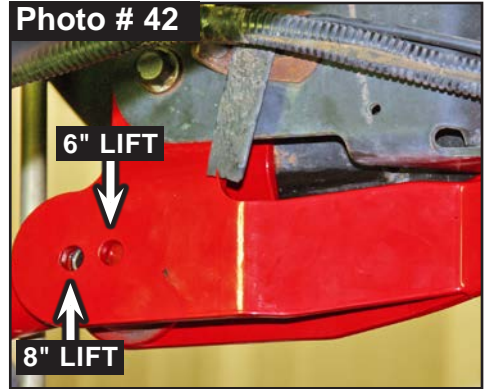
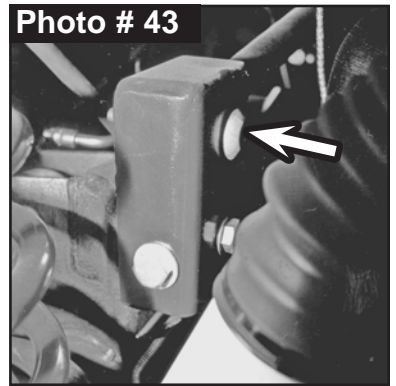

Photo # 42



20. Attach OEM upper link arm to axle mount with OEM hardware using a 21mm socket \ wrench. **Tech Note:** If the vehicle is equipped with an optional upper link arm eccentric cam bolts, the Cam Bolts Must Be Reused. Secure, but **Do Not Completely Tighten**.
21. Connect OEM rear track bar to Skyjacker rear track bar bracket with OEM hardware from rear-to-front using a using a T55 Torx bit. (See Photo # 43) Secure, but **Do Not Completely Tighten** at this time. **Tech Note:** It may be necessary to raise \ lower axle to align track bar bolt. A ratchet strap can be helpful to align track bar / bracket.

Photo # 43



22. Locate Skyjacker # RBL98 Rear Brake Lines. Install now per separate instructions.

Connect OEM rear emergency brake cables.

23. Locate Skyjacker # SBE506-L Rear Sway Bar End Links. Coat # Hourglass 3/4 Bushings & # 142118 Steel Sleeves with a water resistant grease & press into upper & lower end link mounts.
One side at a time, install Skyjacker End Links with OEM hardware with large washer to bushing side of end link using a 18mm socket \ wrench. (See Photo # 44)
Secure, but **Do Not Completely Tighten** at this time.

Photo # 44

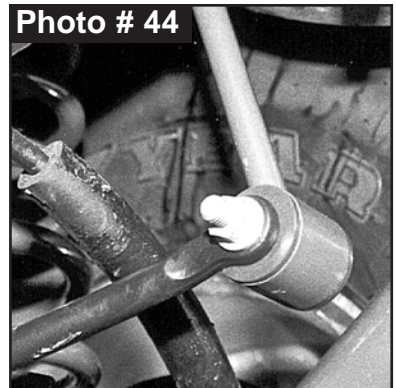

24. Locate Skyjacker # JRSRB1-B Rear Lower Shock Relocation Bracket & hardware bag. Install now per separate instructions.

NOTE: If installing HYDRO, NITRO, Black MAX, or M95 Monotube Shocks: Proceed to Step 25. If installing ADX 2.0 Remote Reservoir Shocks: Proceed to Step 26.

25. Install Skyjacker rear shock. Connect upper bar pin mount with OEM hardware using a 15mm socket \ wrench.

Connect lower axle mount with OEM hardware using a 18mm socket \ wrench. Secure, but **Do Not Completely Tighten** at this time.

26. Assemble Skyjacker ADX rear shock. Loosely assemble two (2) supplied reservoir clamps with two (2) supplied hex head bolts using a 5/32" Hex Key socket. Position clamp into place around shock & reservoir cylinder. Secure, but **Do Not Completely Tighten** at this time.

Install Skyjacker ADX rear shock. Connect upper bar pin mount with OEM hardware using a 15mm socket \ wrench.

Connect lower axle mount with OEM hardware using a 18mm & a 15mm socket \ wrench.

Secure, but **Do Not Completely Tighten** at this time. **Tech Note:** Remote reservoir is to be mounted toward rear of vehicle & rotated for proper clearance.

27. Install the rear tires \ wheels using a 3/4" or 18mm socket & lower the vehicle to the ground.

Final Clearance Check & Torque Steps:

Notes: Check Front Center Axle Disconnect (CAD) connection & on **RUBICON** Models: Check Front & Rear locker connections.

The Drag Link Must Be Adjusted to Center the Steering Wheel Before the Vehicle Is Driven. Failure to Do So Will Cause Computer Errors, Odd Handling Characteristics, & Poor Performance.

1. Start vehicle. Make sure there are no dash lights pertaining to suspension.
2. Jounce vehicle a couple of times. This will help suspension settle to new ride height. Cycle steering lock-to-lock & check all components for proper operation & clearances. Pay special attention to clearance between tires \ wheels, ADX Shocks & Reservoirs, control arms, brake hoses, ABS wiring, etc.

Rotate the drive shafts & check for interference at the differential yoke & Cardan joint. If necessary, lightly dress the casting(s) and \ or u-joint tabs in order to eliminate binding.

3. Front Tighten & Torque Sequence.

Skyjacker track bar at lower axle \ bracket mount using a 5/32" Hex Key Socket & 3/4" socket \ wrench. Torque 90 ft-lbs.

Skyjacker track bar at upper frame mount using a 3/4" socket \ wrench. Torque 90 ft-lbs.

Front shock absorber upper mount using a 15mm socket \ wrench. Torque 17 ft-lbs.

Front shock absorber lower mount using a 13mm socket \ wrench. Torque 250 in-lbs.

ADX Reservoir clamp. Double check position & clearance. Tighten with 5/32" Hex Key socket.

Sway bar end link upper bolt using a 3/4" socket \ wrench. Torque 90 ft-lbs.

Sway bar end link lower bolt using a 18mm socket \ wrench & T55 Torx bit. Torque 75 ft-lbs.

Skyjacker sub-frame lower link arm mount bolts using a 3/4" socket \ wrench. Torque 90 ft-lbs.

Skyjacker upper link arm bracket mount bolt using a 21mm socket \ wrench. Torque 120 ft-lbs.

Skyjacker upper link arm at frame bracket mount using a 15mm socket \ wrench. Torque 60

ft-lbs. Skyjacker upper link arm at axle mount using a 21mm socket \ wrench. Torque 60 ft-lbs.

Skyjacker lower link arm at axle & sub-frame mounts using a 21mm socket \ wrench. Torque 130 ft-lbs.

4. Rear Tighten & Torque Sequence.

Skyjacker track bar bracket bolts. 1/2" Bolt Torque 65 ft-lbs. 12mm Bolt Torque 75 ft-lbs.

Track bar at Skyjacker bracket using a T55 Torx bit. Torque 74 ft-lbs.

Rear shock absorber upper mount using a 13mm socket \ wrench. Torque 26 ft-lbs.

Rear shock absorber lower mount using a 18mm & a 15mm socket \ wrench. Torque 74 ft-lbs.

ADX Reservoir clamp. Double check position & clearance. Tighten with 5/32" Hex Key socket.

Sway bar end link mounts using a 18mm & a 15mm socket \ wrench. Torque 40 ft-lbs.

Skyjacker sub-frame lower link arm mount bolts using a 3/4" socket \ wrench. Torque 90 ft-lbs.

Skyjacker upper link arm bracket mount bolts using a 21mm socket \ wrench. Torque 120 ft-lbs.

Upper link arm at axle & frame mounts using a 21mm socket \ wrench. Torque 60 ft-lbs.

Skyjacker lower link arm at axle & sub-frame mounts using a 21mm socket \ wrench.

- 1997-2002 Models Torque 130 ft-lbs.
- 2003-2006 Models Torque 150 ft-lbs.

Final Notes:

- After installation is complete, double check that all nuts & bolts are tight. Refer to the following chart for proper torque specifications. (**Note:** Do not re-tighten nuts & bolts where thread lock compound was used.)
- With vehicle placed on ground, cycle steering lock to lock & inspect steering, suspension, brake lines, front & rear drivelines, fuel lines & wiring harnesses for proper operation, tightness & adequate clearance.
- Have headlights readjusted to proper settings.
- Have a qualified alignment center align vehicle to OEM specifications.
- After first 100 miles, check all hardware for proper torque & periodically thereafter.

TORQUE SPECIFICATIONS					
INCH SYSTEM			METRIC SYSTEM		
Bolt Size	Grade 5	Grade 8	Bolt Size	Class 8.8	Class 10.9
5/16	180 in-lbs	240 in-lbs	6MM	102 in-lbs	108 in-lbs
3/8	30 ft-lbs	35 ft-lbs	8MM	16 ft-lbs	23 ft-lbs
7/16	45 ft-lbs	60 ft-lbs	10MM	32 ft-lbs	45 ft-lbs
1/2	65 ft-lbs	90 ft-lbs	12MM	55 ft-lbs	75 ft-lbs
9/16	95 ft-lbs	130 ft-lbs	14MM	85 ft-lbs	120 ft-lbs
5/8	135 ft-lbs	175 ft-lbs	16MM	130 ft-lbs	165 ft-lbs
3/4	185 ft-lbs	280 ft-lbs	18MM	170 ft-lbs	240 ft-lbs

**The Above Specifications Are Not to Be Used
When the Bolt Is Being Installed With a Bushing.**

Seat Belts Save Lives, Please Wear Your Seat Belt.

Note: 2003-2006 TJ Models Will Require Modifications to the OEM Crossmember \ Skid Plate in order to Install the Skyjacker Sub-Frame.

Locate the supplied Cut Template on the last pages of this installation instruction manual. Cut out the template using the 'outside' edge of the lines as a guide.

1. With the skid plate removed, use the supplied templates to scribe & cut the rear of the OEM transfer case skid plate. Place the template on the outer profile of the OEM skid plate. The template will line up with the outer rear edge of the skid plate as shown for the Driver Side & for the Passenger Side. (See Photo # 1 # 2, & # 3)



2. Photo # 4 shows the removed portion of the driver side.

Photo # 5 shows the removed portion of the passenger side.

Note: File smooth any burrs or sharp edges on OEM skid plate, then paint or undercoat all exposed metal surface areas.

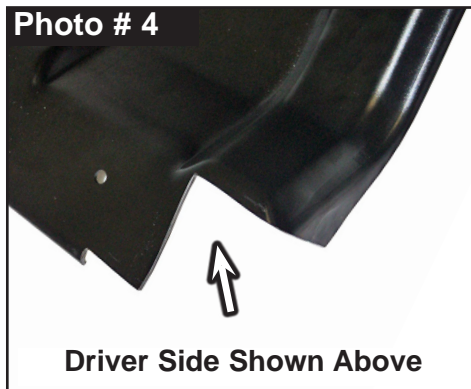

3. With skid plate modified, locate Skyjacker Skid Plate Rear Mounting Brackets. (# TJ03SPRDB-1 Driver & # TJ03SPRPB-2 Passenger)

Mount Skyjacker skid plate bracket to Skyjacker Link Arm Mounting Points on the sub-frame. Install bracket so that it is flush against the sub-frame & the back of OEM skid plate. Mount using the OEM lower link arm bolt. (See Photo # 6)

4. Once installed, mark & drill the new mounting point on the skid plate using a 3/8" drill bit. Install & tighten with supplied 3/8" x 1-1/4" Bolt with 3/8" SAE Washer outside & 3/8" SAE Washer with Nylon Insert Lock Nut inside using a 9/16" socket \ wrench. Torque 35 ft-lbs.

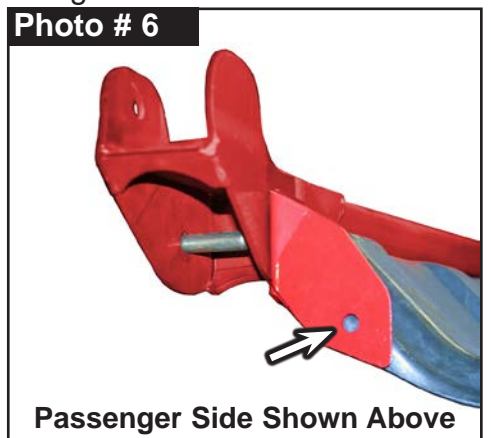

Refer Back to Step 18, Page 6 Lift Kit Instructions at this Time.

Note: Cut out template using the 'outside' edge of the lines as a guide.

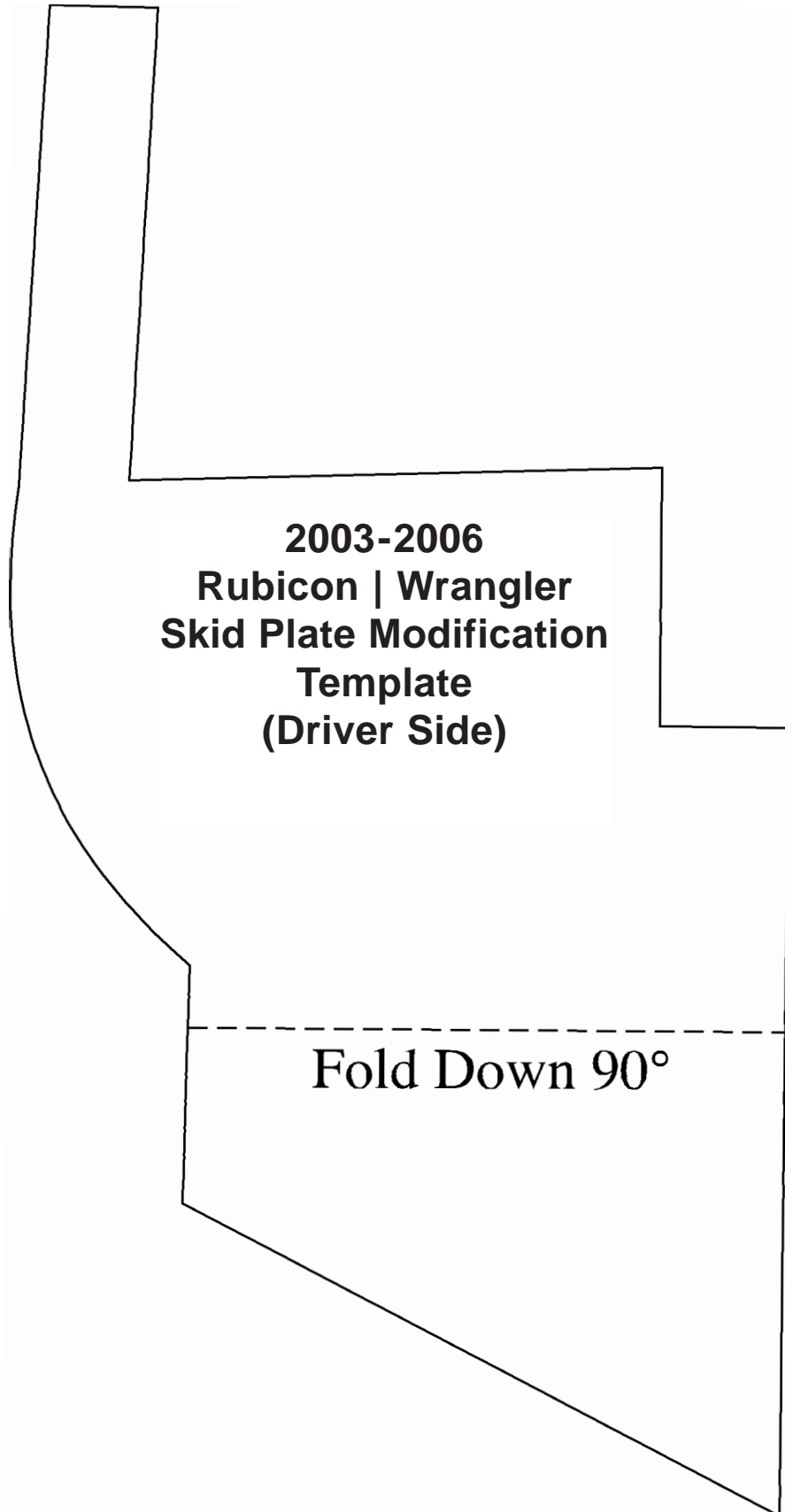

Note: Cut out template using the 'outside' edge of the lines as a guide.

