

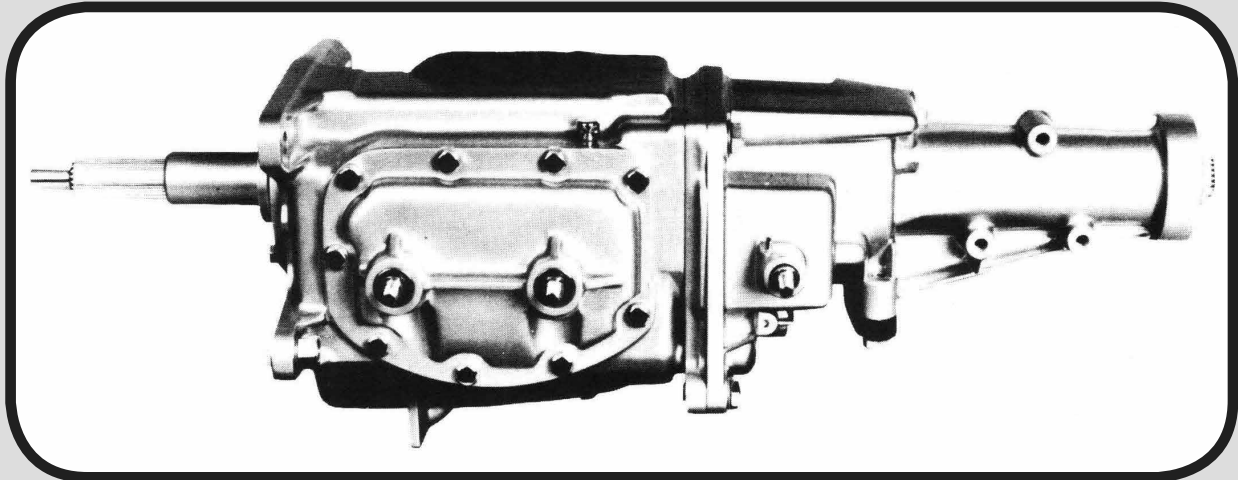

Hi-Performance Transmissions

SUPER T10 ***OWNER'S MANUAL***



Chicago, IL USA
Tech Line: 864-843-9275
Fax: 864-843-1276
Email: techsupport@richmondgear.com

IMPORTANT

Read all information prior to installing and operation of Transmission. Injury to personnel or Transmission failure can be caused by improper installation, operation, lubrication and maintenance.

Check to make certain the application does not exceed the allowable load capacities published in the catalog.

Buyer shall be solely responsible for determining the adequacy of the product for any and all uses to which buyer shall apply the product. The application by buyer shall not be subject to any implied warranty of fitness for that particular purpose.

*Proudly assembled and individually tested
in the USA. Manufactured using top grade
materials, statistically controlled CNC
machinery, state-of-the-art heat treating.*

CAUTION: Units are shipped WITHOUT lube oil. Fill **immediately**.

TABLE OF CONTENTS

Super T10 Features and General Specifications _____	2
<u>SERVICE PROCEDURES</u>	
Bellhousing Alignment _____	3-4
Lubricants and Sealants _____	6
Installation _____	3-5
General _____	6
Disassemble _____	6-7
Clean and Inspect _____	7
Assemble _____	7-8
Torque Values and Specifications _____	9
Exploded View _____	11
Replacement Parts _____	12
Tooth Counts by Gear Number _____	13-14
Troubleshooting _____	15
Speedometer Information _____	16
Notes _____	10, 17-18

WARRANTY INFORMATION

Warranty is limited to material and/or workmanship defect at time of shipment from the factory, and in no event shall seller have any liability for consequential damages of any kind resulting from a breach of this warranty. This warranty will be void on all products that show evidence of misapplication, improper installation, abuse, lack of proper maintenance, negligence, or alteration from original design. This warranty is in lieu of any other warranties, either express or implied, INCLUDING ANY IMPLIED WARRANTIES OF MERCHANTABILITY OR FITNESS FOR ANY PARTICULAR PURPOSE.



Chicago, IL USA
Tech Line: 864-843-9275
Fax: 864-843-1276
Email: techsupport@richmondgear.com

SUPER T10

Born in the "Muscle Car Era" of the 1960's, the Richmond Super T10 has been redesigned and improved for the 21st century. NASCAR proven, the current Super T10 is 10 pounds lighter and 50% more durable than the original.

The Super T10 is deigned to provide improved acceleration potential while best utilizing the advantages of a four speed transmission.

A four speed ccountershaft helical gear transmission, the Super T10 is synchronized in all forward gears. First and reverse are "constant mesh" to prevent gear "clash", while strut-type synchronizers provide longer life and easier shifting.

Four models are available to fit specific applications. All four ratio sets provide a low first gear while retaining a relatively close spacing between 2nd to 3rd and 3rd to 4th shifts.

The Richmond Super T10 should be your choice gor performance type automobiles, light trucks and selected models of intermediate and full-sized cars. Our engineering expertise and a "PRO-QUALITY" approach to drivers demanding winning performance are built into every transmission that wears the Richmond name.

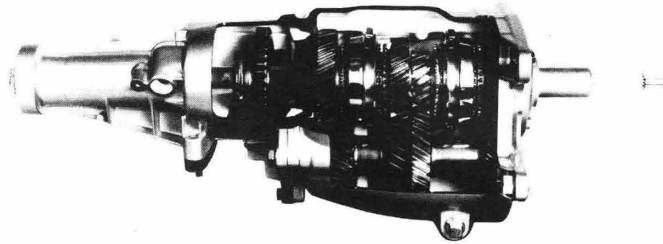
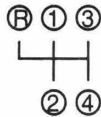

Super T10 Plus Part #	Super T10 Part #	1st	2nd	3rd	4th	Rev.	Torque
7021510	1304000070	2.43	1.61	1.23	1.00	2.35	375 fp (5.19 kg.m.)
7021520	1304000069	2.64	1.75	1.34	1.00	2.55	325 fp (44.9 kg.m.)
7021530	7021090	2.64	1.60	1.23	1.00	2.55	325 fp (44.9 kg.m.)
7021540	1304000072	2.88	1.91	1.33	1.00	2.78	300 fp (41.5 kg.m.)
7021550	1304000062	2.88	1.74	1.33	1.00	2.78	300 fp (41.5 kg.m.)
7021560	1304000071	3.42	2.28	1.46	1.00	3.51	266 fp (39.kg.m.)

Parenthetical dimensions are expressed metrically.

Center Distance _____ 3.25 inches (82.55mm)

Oil Capacity _____ 2.4 U.S. pints (1.14 liters)

Approximate Dry Weight _____ 70 lbs. (31.8 kg.)

Case & Extension Housing _____ Aluminum

Controls _____ Side Lever

INSTALLATION

INSTALLATION

As with any high performance product, proper installation and set-up is critical for optimum performance. The following are a few helpful hints to help you get the maximum performance from your new Richmond Transmission.

** Shifter Set-Up

Mount and adjust the shifter linkage before you install the transmission. Make sure that all rods are mounted and working freely without binding at the shifter hangers or the transmission itself. (Be sure rod adjustment is made with the rail alignment pin in place.) Once rods are set, set the shifter stops to prevent overshift.

** Lubrication

Many technological improvements in gear lubricants are available in the market today. It is hard to recommend one particular product for all applications. Thus far in our testing we found that a standard 85-90 wt. Petroleum oil will suit most applications. Synthetic gear lube, however, may be used to improve shiftability or cold weather start-up. This transmission is a significant investment, and you certainly don't want to ruin your transmission with a cheap lube. We recommend **Richmond GL6** synthetic manual transmission fluid.

** The Clutch

The clutch can truly be THE difference in the smoothness and shiftability of any transmission. In general, the more mass in the clutch, the more difficult shifting becomes. And, of course, shifting at high rpm makes proper of clutch adjustment essential. In our testing thus far we have found a good starting point is .070" clearance.

** Bellhousing Alignment

Proper alignment of bellhousing to the motor is critical! The most common problems associated with a misaligned bellhousing are: jumping out of gear, vibration, excessive pilot bushing wear, difficult shifting, or excessive wear of the tailhousing bushing.

OEM and high performance drive train components have manufacturing tolerances which can shift the bellhousing into an unacceptable position.

From the engine block viewpoint, all machining for the main bearings is done at a right angle to the surface where the bellhousing bolts to the block. Anytime an engine is lined-honed or bored, it could move the crankshaft centerline to the dowel pins at the rear of the block.

Whenever a new bellhousing or a rebuilt motor is involved, we strongly recommend indicating the bellhousing to assure proper alignment.

An article specific to proper bellhousing alignment is included for your understanding of the importance of this matter. See following article for further instructions.

BELLHOUSING ALIGNMENT

Bellhousing alignment is absolutely essential to smooth and reliable clutch and transmission operation. Of major importance is the position of the bellhousing on the rear of the engine; the centerline of the transmission input shaft must line up exactly with the centerline of the crankshaft. In addition, the transmission mounting surface (rear of the bellhousing) must be parallel to the clutch engagement surface of the flywheel.

All too frequently, the bellhousing or scattershield, is merely bolted up by using the factory installed dowel pins as a guide. But the placement of the dowel pins and the positioning of the dowel pin holes in the bellhousing can be affected by the manufacturing tolerances of mass-production. Frequently, these tolerances multiply to produce a considerable alignment error.

A variety of problems can result from the bellhousing being out of alignment: pilot bearing failure, transmission bearing failures, clutch chatter, sloppy shifts, sluggish clutch movement, rapid synchronizer wear, or popping out of gear. And of course, the transmission and/or clutch takes the blame for what is really a bellhousing alignment problem.

A dial indicator (with a magnetic base) is needed to verify bellhousing alignment. Using stock dowel pins, install the bellhousing and tighten securely. The trueness of the flywheel should be the first checkpoint, because all subsequent alignment checks will use the flywheel face as a measuring point. The flywheel face must be perpendicular to the centerline of the crankshaft if consistent, smooth clutch action is to occur. This can be determined by mounting the dial indicator on the bellhousing. Rotate the crankshaft slowly recording any variations on the dial indicator, by measuring from the flywheel to the bellhousing face (a runout of .005" is acceptable). If the flywheel runout is more than .005", check for dirt or burrs on the faces of the flywheel or crankshaft. If there are none, flywheel warpage may be the problem and the flywheel may be in need of resurfacing.

Next, affix the dial indicator to the flywheel (prior to clutch installation) and attached the indicator so that it contacts the bellhousing's transmission mating surface about one inch outside the rear opening. (Be sure to avoid the transmission mounting bolt holes and clutch pivot ball hole.) Rotate the crankshaft by hand slowly and note any variations

in the indicator reading to determine if the surface is parallel with the flywheel. Maximum variation between the highest and lowest readings is .005". If a greater variation is found, place shim stock in line with the low point between the bellhousing and the block. Adjust shim thickness until variation of .005" or less are obtained. Again, carefully check the mating surfaces for dirt and burrs to make sure these are not causing the problem.

Remount the dial indicator so that it measures the inside diameter of the rear opening in the bellhousing. Once again, be sure there is no paint buildup, nicks or burrs on the edges of the opening. Slowly, rotate the crankshaft and check the dial indicator readings. The maximum variation is 0.10" because the actual error is the total variation divided by two, or .005" misalignment. If the variation exceeds .010" realignment is required. Make several revolutions of the crankshaft to verify the readings.

If the bellhousing must be realigned, one of several approaches can be used, in any case, the stock dowel pins must be removed from the block and discarded. The stock pins must be removed carefully to avoid distorting or otherwise damaging the pin holes.

The first method consists of simply loosening the bellhousing bolts to permit repositioning of the bellhousing until dial indicator reading variation of .010" or less is obtained. It may be necessary to enlarge the bellhousing bolt holes slightly to obtain sufficient movement. Then tighten the bolts and recheck it to ensure the housing hasn't shifted. With the bolts securely tightened and the housing properly aligned, choose two points, approximately 180 degrees apart. It will be necessary to drill through the bellhousing flange and into the block for installation of the new dowel pins. The new pins need not be as large as the stock

ones. A diameter of 1/4 - 5/16" is sufficient. Once the new pins are in place, the bellhousing can be removed and reinstalled without the need to check alignment.

The second method utilizes offset dowel pins. These special pins are offered in three offsets, .007", .014" and .021", in both 5/8" and 1/2" diameters. Before installing the offset pins, drill and tap a small hole in the side of each dowel pin hole (in the block) so that a small Allen-head set screw can be used to lock the offset pins in place after alignment is completed.

When installed, the offset dowel pins can be adjusted with a screwdriver to obtain proper alignment. In some cases the dowel pins must be polished with a strip of emery cloth to permit them to be rotated in the dowel pin holes with a screwdriver. Adjustment with these offset pins can be tedious and time consuming, so be patient. After this is completed, tighten all bellhousing bolts and recheck the alignment one more time. If everything is okay, the bellhousing portion of the job is done.

But there's one more part to check; the front bearing retainer on the transmission. The outer diameter of this retainer, not the transmission bolts, determines placement of the transmission on the bellhousing. Therefore, it is important that the bearing retainer be matched to the bellhousing being used. The retainer should fit snugly in the opening into the bellhousing. If it doesn't another retainer of the proper diameter must be used.

"Bellhousing Alignment" article compliments of G-Force Products.

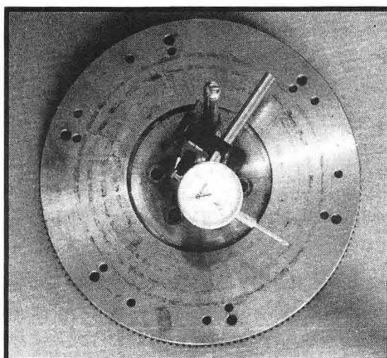

This is how the dial indicator must be positioned to check concentric alignment of the rear bellhousing opening with the crankshaft centerline.

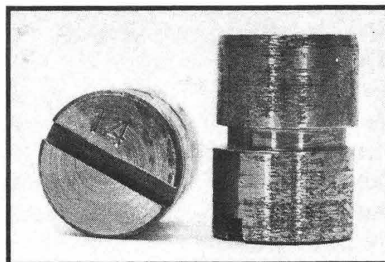

Shown is a pair of the offset dowel pins, along with two 10-32 set screws to lock the dowels in place when the alignment process is completed.

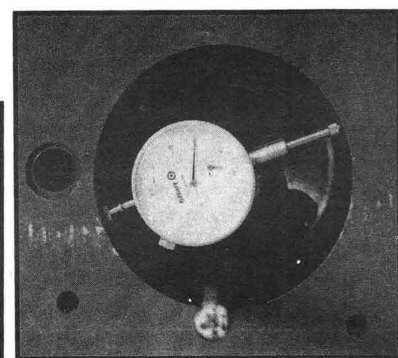

When bellhousing alignment is complete, tighten the set screws to secure the dowel pins for future reassembly without the hassles of realignment.

INSTALLATION INSTRUCTIONS

Items recommended or required to complete the installation of the Super T10 and Super T10 Plus:

1. Transmission Mount: There were two types of transmission mounts used in early GM automatic and manual transmissions, a single stud mount, GM part number 17982949, and a double stud mount, GM part number 3913498 (discontinued from GM). Richmond makes a universal polyurethane mount that will fit both applications, Richmond part number 86-0010-1, and we highly recommend that you use this mount when installing your new Super T10 or Super T10 Plus transmission.

2. Shifter Assembly: We recommend a LONG shifter part number HB1000S. This shifter and rail assembly will put the centerline of your shifter 19" from the front face of the transmission. Some of the earlier GM's had a shifter centerline at 17.5", which we do not make a shifter for.

3. Speedometer Drive and Driven Gear: If you are replacing a 4 speed or a Turbo 350 with a Super T10 or Super T10 Plus, you will be able to use your original speedo driven gear holder. If not, or you would like to replace your original, you can purchase Richmond part number 345215. Your Super T10- transmission comes with an 8 tooth drive gear, and multiple driven gear options are available, please see page 15 for a list of options, as well as a speedometer gear ratio formula.

4. Yokes: All Super T10 and Super T10 plus transmissions use a 32 spline, turbo 400 slip yoke. Richmond makes these in 1310, part number SY-1310, 1330, part number SY-1330, and 1350, part number SY-1350.

5. Bellhousing: Your Richmond T10 transmission will bolt up to your factory 4-speed bellhousing, or aftermarket bellhousing.

Step 1 Remove the Current Transmission
Remove the current transmission from the car.

Step 2 Mounting the Shifter
Attach the shifter plate to the transmission. With the shifter rail alignment pin installed, mount and adjust all shift rods so there is no binding of the rods. **Remove the alignment pin.** Shift transmission through all gears. Interference will cause **hard shifting.** Once the rods are in place, set the shifter stops to prevent overshift. Once the shifter is set, remove all rods and the shifter plate from the transmission. The transmission is now ready to install.

Step 3 Installing the Transmission
Install the transmission. Once transmission is aligned, slide forward to set flush with bellhousing. Tighten all bolts to approximately 40 ft. lbs. Next lift the shift assembly into position, pushing shifter handle through the shifter boot. Now bolt the shifter assembly into place. Mount all rods (make sure alignment pin is in place for installation). Remove pin and shift through the gears. Make sure rods are still moving freely.

Step 4 Install Mounting Pad
Align the mounting pad to the transmission. Install (2) bolts and torque to approximately 40 ft. lbs.

Step 5 Install Crossmember
Bolt the crossmember to the mounting pad. Bolt crossmember into position.

Step 6 Install Spedometer
Install proper speedometer gear and housing in tail-housing. (These components can sometimes be used from your old GM transmission.) Connect speedometer cable.

Step 7 Drive Shaft Installation
Install Drive Shaft. Again, be sure that you have adequate clearance from the end of the transmission to the face of the yoke.

Step 8 Recheck Installation
Go over entire installation, being sure bolts are tight and shifter rods are working freely.

Step 9 Lubrication
Fill the transmission with Richmond TLUBE gear lube, filling to the bottom of the pipe plug.

Your transmission should now be ready for many miles of great service. You will find the shifter and synchronizers will have a tendency to "break in" and actually perform better after a few miles.

If you have any technical questions on the transmission, call the Tech Line at Richmond Gear at 864-843-9275.

WARNING: All mounting bolts used to install the transmission in your car should be grade 5 or higher. All mounting bolts should be checked periodically to make certain they maintain proper torque.

WARNING: Never operate the transmission without proper amounts of correct lubricant. Never allow vehicle to idle in neutral without applying parking brake. Check oil level between scheduled oil changes to insure proper oil changes to insure proper oil level is maintained.

The manufacturer makes no warranty or representations, expressed or implied, by operation of law or otherwise, as to the merchantability or fitness for a particular purpose of the goods sold hereunder. Buyer acknowledges that it alone has determined that the goods purchased hereunder will suitably meet the requirements of their intended use. In no event will the manufacturer be liable for consequential, incidental or other damages.

This instruction manual should be read together with all other printed information, such as catalogs, supplied by Richmond Gear.

These instructions do not purport to cover all details or variations in equipment, nor to provide for every possible contingency to be met in connection with selection, installation, operation, lubrication, and maintenance. Should further information be desired or should particular problems arise which are not covered sufficiently for the purchaser's purpose, the matter should be referred to Richmond Gear.

Richmond Super T10 Service Procedures

GENERAL

Do not open a healthy transmission except for pre-race inspection or to change ratios. Improper rebuilding may damage the assembly. List all symptoms and study the troubleshooting guide before opening the unit. Use proper tools on a clean bench. Carefully follow the procedures, refrain from using unnecessary force, and work at a sensible speed.

LUBRICANTS AND SEALANTS

- **Choose an operating lubricant to meet the vehicle service cycle. Fill with 1-1/4 quarts (2.4 pints) of Richmond™ GL6 Manual Transmission Fluid Part# TLUBE**
- Use the operating lubricant to lubricate the running surfaces of all gears and bushings during assembly.
- Retain loose rollers, thrust washers, and spacers with petroleum jelly during assembly. **Do not use grease.** Grease provides inadequate lubrication and will not dissolve in oil.
- Apply sealing cement to all through bolts, fill and drain plugs, and idler shaft cup plug during assembly.
- When called for, use gaskets to seal mating parts. Substituting RTV sealant may reduce or eliminate required clearances.

DISASSEMBLE

Follow the manufacturers recommended procedure to remove the transmission from the vehicle. *Threading TWO (2) STUDS in the upper mounting holes will support the transmission and protect the clutch disc.*

1. If not done previously, drain the lubricant. Caution: Used transmission oil contains harmful contaminants that have caused skin cancer in laboratory animals. Avoid prolonged skin contact, Clean skin and nails thoroughly using soap and water - not mineral oil, fuels, or solvents. Launder or discard clothing, shoes, or rags containing used transmission oils.
WARNING: Hot oil and transmissions can cause severe burns. Use extreme care when removing lubrication plug.
2. Shift the transmission into neutral. Remove the shift cover assembly, gasket, and fasteners.
3. Remove the maindrive retainer, gasket, and fasteners.
4. Remove the reverse shift lever taper pin by driving toward the rear.
5. Remove the extension assembly, gasket, and fasteners. Use a soft hammer to free the extension, pulling the reverse shift lever assembly outward to separate the reverse shift fork and mainshaft reverse gear.
6. Remove the rear idler gear, rear idler thrust race and bearing (washer on some models).
7. Remove the speedometer circle gear and mainshaft reverse gear.
8. Remove the mainshaft and mainshaft bearing support as an assembly.
9. Remove the mainshaft pilot rollers and synchronizer ring.
10. Remove the front idler gear and front idler gear thrust washer.
11. Remove the maindrive bearing assembly by tapping from the inside of the case outward.
13. Drive the countershaft toward the rear and remove. Remove the countershaft cluster gear assembly

Richmond Super T10 Service Procedures

and separate the countershaft thrust washers, rollers, roller spacers, roller tube, and countershaft cluster gear.

14. From the mainshaft assembly, remove the 3rd/4th synchronizer snapping 3rd/4th synchronizer assembly, and mainshaft 3rd gear.
15. With the pilot end down, support the mainshaft assembly under the mainshaft bearing support. Spread the mainshaft bearing/support snapping and press the mainshaft assembly through the support.
16. With the pilot end down, support the mainshaft assembly under the mainshaft 2nd gear. Remove the mainshaft bearing/shaft snapping and spacer. Press the mainshaft through and separate the mainshaft bearing, mainshaft 1st gear and sleeve, 1st/2nd synchronizer assembly, and mainshaft 2nd gear.
17. From the extension assembly, remove the idler shaft lockpin plug. Drive the idler shaft lockpin into the idler shaft clearance hole and remove the shaft and pin. Remove the reverse shift fork. Drive the reverse shift lever assembly inwards and remove the lever, detent ball, and detent spring.

CLEAN AND INSPECT

1. Wash the case, extension, mainshaft bearing support, shift cover, and maindrive retainer thoroughly inside and out, removing all dirt, metal, and loose contaminants. Inspect all mating surfaces for dings and burrs and remove where found.
2. Wash the ball bearings in cleaning solvent. Blow out with dry compressed air while slowly turning the bearings by hand. **Do not allow the bearings to spin.** Lubricate and inspect. Replace the bearings if rough, noisy, or excessively loose.
3. Inspect all loose rollers, thrust washers, and spacers for wear and replace if necessary. Replace all spread or twisted snaprings. Use new parts (from a small parts kit) whenever possible.
4. Inspect the countershaft for wear and replace if pitted or worn.
5. Inspect all gears for missing, broken, or damaged teeth and replace if necessary. Small chips and blemishes can be blended with a die grinder to reduce induced noise. Replace any heat damaged ("blued") gear or shaft.
6. Inspect the synchronizer rings and gear for complete clutch teeth, without burrs. The rings should have straight (not flared or "bell-mouthed") strut pockets, fit the mating cones without rocking, and leave a gap when pressed tight. The gear cones should not show excessive polish, but have a uniform taper without ridges. Replace if necessary.
7. Inspect the synchronizers for broken, distorted, or worn struts. Hubs should be without burrs, and with straight strut pockets. Replace if necessary.
8. Remove and discard old oilseals and gaskets.

ASSEMBLE

1. Press the maindrive bearing on maindrive. Assemble maindrive bearing/shaft spacer and retain with the thickest snapping that will go on (*endplay should not exceed 0.005"*) Some early assemblies used a left-handed nut which should be tightened and staked.
2. Assemble the countershaft cluster gear assembly. Retain the countershaft roller tube, rollers, and roller spacers in the gear with petroleum jelly. Lock each roller track by installing the last roller endwise.
3. Rest the case with the side opening up. Place the countershaft thrust washer tangs in the notches provided and retain with petroleum jelly.
4. Carefully, set the countershaft cluster gear assembly in the case without disturbing the countershaft thrust washers. Do not install the countershaft at this time.

Richmond Super T10 Service Procedures

5. Pass the maindrive assembly through the side opening and gently tap into place. Retain with the maindrive bearing/case snapping.
6. Place the countershaft cluster gear assembly in mesh with the maindrive. Install the countershaft key and press in the countershaft until flush with rear of case. *The countershaft cluster gear must spin freely and endplay must not exceed 0.025".*
7. Assemble the synchronizers. The 1st/2nd synchronizer assembly (*10 spline*) is correctly assembled when the clutch taper faces 1st gear and the long hub faces 2nd gear. The 3rd/4th synchronizer assembly (*6 spline*) is correctly assembled when the clutch taper and the long hub face the maindrive.
8. Assemble the mainshaft 2nd gear, synchronizer ring, and 1st/2nd synchronizer assembly on the mainshaft. Press the mainshaft 1st gear bushing until seated against the synchronizer hub. Assemble a second synchronizer ring, mainshaft 1st gear, and mainshaft 1st gear thrust washer on the mainshaft. *Insure that the oil grooves on the thrust washer face 1st gear and the synchronizer struts fall in the ring strut pockets.*
9. Press the mainshaft bearing tightly against the mainshaft shoulder. Assemble the mainshaft bearing/shaft spacer and retain with the thickest snapping that will go on (*endplay should not exceed 0.005"*).
10. From the front of the mainshaft assemble the mainshaft 3rd gear, synchronizer ring, and 3rd/4th synchronizer assembly. Retain with a narrow (*0.087"*) snapping.
11. Assemble the mainshaft bearing support on the mainshaft. Spread the mainshaft bearing/support snapping and press the mainshaft assembly downward until the snapping relaxes in the bearing groove.
12. Assemble the mainshaft reverse gear with the shift flange toward the rear.
13. Assemble the speedometer circle gear and retain. Early General Motors assemblies use a press-fit steel gear which should be driven until centered 4-1/2" behind the rear face of the mainshaft bearing support.
14. Stand the case upright, resting on the front face with maindrive down.
15. Assemble the mainshaft pilot rollers in the maindrive and retain with petroleum jelly. Place the remaining synchronizer ring on the maindrive cone and the mainshaft bearing support gasket on the case. Place the front idler thrust washer and front idler gear on the case idler boss.
16. Lower the mainshaft assembly into the case. Turn the maindrive synchronizer ring until the struts fall in the strut pockets. Install and tighten the mainshaft bearing support bolt.
17. Assemble the rear idler gear through the mainshaft bearing support, engaging the front idler gear already in the case. Place the mainshaft extension gasket on the support.
18. Press the idler gear shaft into the extension. Retain with idler shaft lockpin and seat the opening with the idler shaft lockpin plug. Assemble the rear idler gear thrust race and bearing (washer only on some assemblies) on the idler shaft and retain with petroleum jelly.
19. Shift both synchronizers to neutral (*centered clutches*).
20. Assemble the detent ball, detent spring, reverse shift lever assembly and reverse shift fork in the extension. **Do not install the reverse shift lever taper pin until the extension is installed.**
21. Pull the reverse shift lever assembly outwards and toward the extension front. Start the extension onto the mainshaft until the reverse shift fork will fall in the reverse gear flange. Push the reverse shift lever assembly inward and toward the rear as the extension seats. Install and tighten the extension bolts.
22. Line up the groove on the reverse shift lever assembly with the extension hole and press in the reverse shift lever taper pin.
23. Assemble the maindrive retainer, maindrive, oilseal, an gasket. Install and tighten the retainer bolts.

Richmond Super T10 Service Procedures

24. Place forks on each sliding clutch groove. With the shift lever in neutral, assemble the shift cover and shift cover gasket on the forks and seat against the case. Install and tighten the cover bolts. **Check that all ranges are present and that the levers will over shift slightly in all gears before installing the transmission in the vehicle.**

Follow the manufacturers recommended procedure to install the transmission in the vehicle. Threading TWO (2) STUDS in the upper mounting holes will support the transmission and protect the clutch disc.

FILL THE TRANSMISSION WITH LUBRICANT BEFORE DRIVING

1-1/4 qts. (2.4 U.S. pints) of Richmond™ GL6 Manual Transmission Fluid

TORQUE VALUES (Clean new fasteners)

		Initial
Maindrive Retainer Bolts	5/16-18 x 7/8	15-20 lb. ft.
Shift Cover Bolts	5/16-18 x 3/4	15-20 lb. ft.
Extension Housing Bolts	7/16-14 x 1-1/8	20-30 lb. ft.
Extension Housing Bolts	1/2-13 x 1-7/8	35-45 lb. ft.
Bearing Support Bolt	1/2-13 x 1-1/8	30-40 lb. ft.
Drain Plug		15-25 lb. ft.
Fill Plug		25-35 lb. ft.

GENERAL TORQUE SPECIFICATIONS**

GRADE OF BOLT		SAE 1 & 2	SAE 5	SAE 6	SAE 8	N/A*	SOCKET OR WRENCH SIZE	
MIN. TENSILE STRENGTH		60,000 P.S.I.	105,000 P.S.I.	133,000 P.S.I.	150,000 P.S.I.	160,000 P.S.I.		
U.S. STANDARD		TORQUE (IN FT.-LBS.)					U.S. REGULAR	
BOLT DIA.	U.S. DEC. EQUIV.						BOLT HEAD	NUT
1/4	.250	5	7	10	10.5	11	3/8	7/16
5/16	.3125	9	14	19	22	24	1/2	9/16
3/8	.375	15	25	34	37	40	9/16	5/8
7/16	.4375	24	40	55	60	65	5/8	3/4
1/2	.500	37	60	85	92	97	3/4	13/16
9/16	.5625	53	88	120	132	141	7/8	7/8
5/8	.625	74	120	167	180	192	15/16	1
3/4	.750	120	200	280	296	316	1-1/8	1-1/8
7/8	.875	190	302	440	473	503	1-5/16	1-5/16
1	1.000	282	466	660	714	771	1-1/2	1-1/2
MULTIPLY READINGS BY 12 FOR INCH POUND VALUES								

* PREMIER SUPERTANIUM.

** The following rules apply to the chart:

- Figures may be used directly when Never-Seer compound, Molykote, Fel-Pro C-5, graphite and oil or similar lubricants are used.
- Increase torque by 20% when using engine oil or chassis grease as a lubricant (generally not recommended for fasteners).
- Reduce torque by 20% when plated bolts are used.

Information courtesy of P.A. Sturtevant Co.

NOTES

T-10 FOUR SPEED EXPLODED VIEW

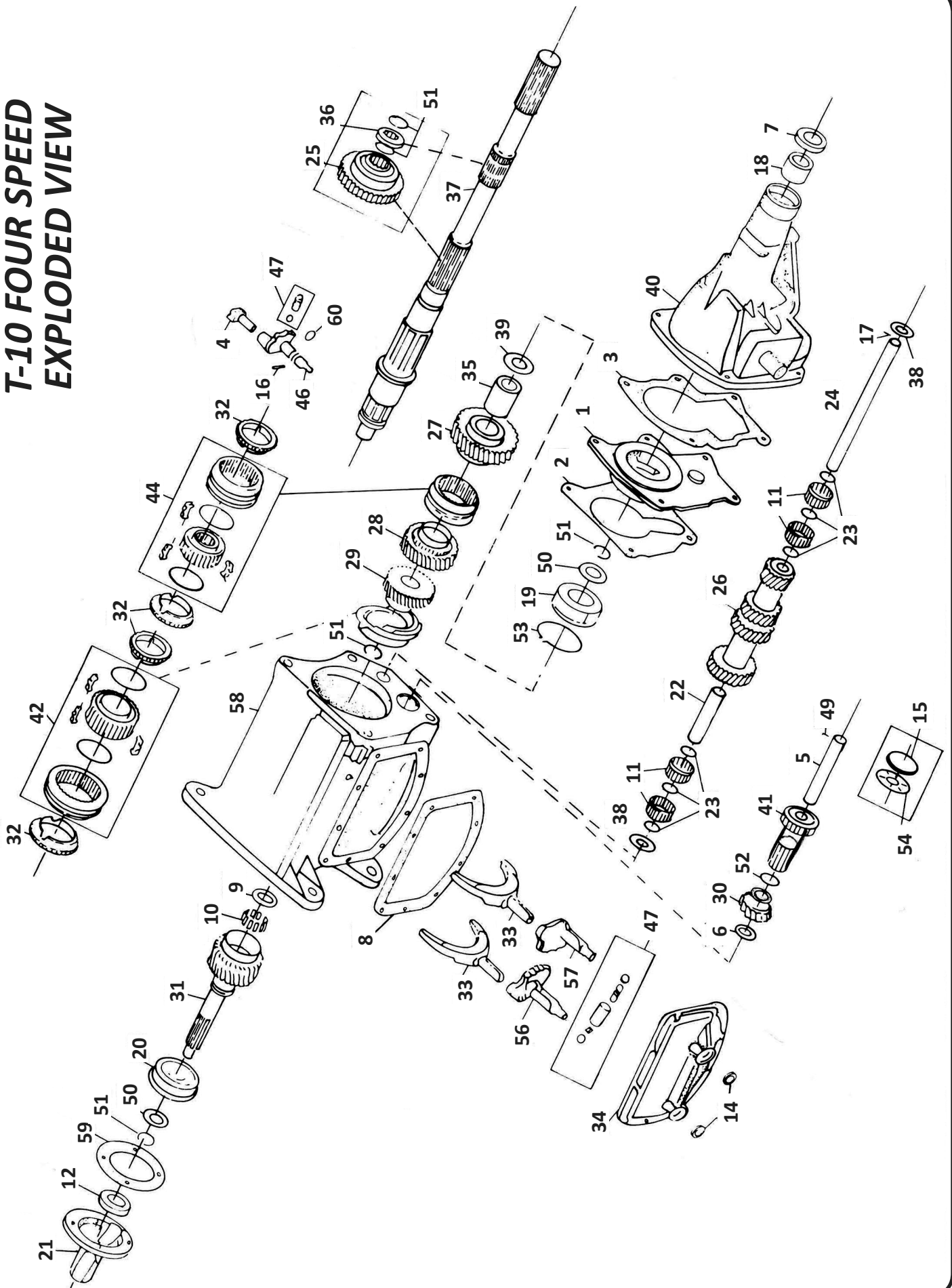

T10 4 SPEED

ASSEMBLIES

Road Race T10Part #	Standard T10 Part #	Description
7021520	1304000069	2.64 W Ratio
7021510	1304000070	2.43 S Ratio
7021540	1304000072	2.88 CC Ratio
7021530	7021090	2.64 X Ratio
7021550	1304000062	2.88 Y Ratio
7021560	1304000071	342. Z Ratio

REPLACEMENT PARTS

View #	Part No.	Description
28	1304080001	Second Gear S, W, CC & Z Ratios
	1304080020	Second Gear X & Y Ratios
29	1304080019	Third Gear X, CC & Y Ratios
	T10S11	Third Gear S & W Ratios
	T10U11	Third Gear Z Ratio
30	1304084005	Reverse Idler Gear All Except Z Ratio
	1304084004	Reverse Idler Gear Z Ratio
31	1304085006	Input Drive S Ratio
	1304085016	Input Drive w & X Ratio
	1304085022	Input Drive CC & Y Ratio
	1304085023	Input Drive Z Ratio
32	1304091002	Brass Synchro Ring
Alt.	1304091010	Brass Synchro Ring Road Race
33	1304096002	Shift Fort
34	1304097004	Side Cover
35	1304103001	First Gear Sleeve
36	1304110002	Speed O Gear
37	1304171005	Mainshaft
38	1304193101	Thrust Washer
39	1304193002	Thrust Washer
40	1304566005	Extension Housing Assy.
41	1304584002	Reverse Idler Gear Assy.
42	1304590007	3-4 Synchro Assy. W/O Brass
43	1304590008	3-4 Synchro Assy. W/Brass
44	1304590010	1-2 Synchro Assy. W/O Brass
45	1304590010	1-2 Synchro Assy. W/Brass
46	1304598003	Reverse Shift Cam Assy.
47	1304603010	Detent Kit
48	1304603011	Small Parts Kits (Needle Bearings, Snap Rings, Spacers and Washers)
	1304603012	Gasket Kit - Consists of 2, 3, 8 & 59 (not shown)
49	456876	Lock Pin
50	4652U	Spacer
51	4734A-E	Snap Ring
52	4821A	Snap Ring
52	4829	Snap Ring
54	7880010	Needle Thrust Bearing
55	6291034	Key and Spring Kit
56	6680025	3-4 Shift Cam Assy.
57	6692012	1-2 Shift Cam Assy.
58	7180049	Main Case
59	8195086	Bearing Retainer Gasket
60	8280040	"O" Ring
43	1304590016	3-4 Synchro Assy. W/Brass
Alt.		Road Race
45	1304590018	1-2 Synchro Assy. W/Brass
Alt.		Road Race

REPLACEMENT PARTS

View #	Part No.	Description
1	AT10107A	Rear Adapter Assy.
2	T101451/2C	Adapter Gasket
3	T10146 A	Adapter Gasket
4	T1024	Reverse Shift Fork
5	T1035	Reverse Idler Shaft
6	T1088A	Thrust Washer
7	T22110A	Ext. Housing Seal
8	T85B115	Side Cover Gasket
9	T85G25	Spacer
10	T85G26	Input Needle Bearing
11	T86166	Cluster Needle Bearing
12	T89C54	Front Bearing Retainer Seal
14	T90A108	Control Housing Seal
15	8680003	Thrust Plate (2 Required)
16	103565	Taper Pin
17	103905	Woodruff Key
18	1000127050	Extension Housing Bushing
19	1000130010	Mainshaft Bearing
20	1000130010	Input Bearing
21	1304027001	Front Bearing Retainer
Alt.	1304027010	Frnt. Bearing Ret. Road Race
22	1304053003	Cluster Bearing Spacer
23	1304053004	Cluster Bearing Washer
24	1304068001	Cluster Shaft
25	1304070002	Reverse Gear
26	1304077008	Cluster Gear 2.64 W Ratio
	1304077009	Cluster Gear 2.43 S Ratio
	1304077010	Cluster Gear 2.64 X Ratio
	1030477012	Cluster Gear 2.88 Y Ratio
	1304077016	Cluster Gear 3.42 Z Ratio
	1304077017	Cluster Gear 2.88 CC Ratio
27	1304080004	First Gear All Except Z Ratio
	1304080023	First Gear Z Ratio

Tooth Counts By Gear Number

1304000070 and 7021510 (2.43-1.61-1.23-1.00)		
Input	1304085006	21 T.
1st Gear	1304080004	34 T.
2nd Gear	1304080001	25 T.
3rd Gear	T10S11	22 T.
Cluster	1304077009	27-23-20-18 T. 2 Grooves
Rev. Gear - Slider	1304070002	39 T.
Rev. Idler	1304084005	16 T.
Rev. Assembly	1304584002	19 T.
Input - 2 I.D. Grooves		

1304000069 and 7021520 (2.64-1.75-1.34-1.00)		
Input	1304085016	20 T.
1st Gear	1304080004	34 T.
2nd Gear	1304080001	25 T.
3rd Gear	T10S11	22 T.
Cluster	1304077008	28-23-20-18 T. 3 Grooves
Rev. Gear - Slider	1304070002	39 T.
Rev. Idler	1304084005	16 T.
Rev. Assembly	1304584002	19 T.
Input - 3 I.D. Grooves		

7021090 and 7021530 (2.64-1.60-1.23-1.00)		
Input	1304085016	20 T.
1st Gear	1304080004	34 T.
2nd Gear	1304080020	24 T.
3rd Gear	1304080019	21 T.
Cluster	1304077010	28-24-21-18 T. 5 Grooves
Rev. Gear - Slider	1304070002	39 T.
Rev. Idler	1304084005	16 T.
Rev. Assembly	1304584002	19 T.
Input - 3 I.D. Grooves		

1304000072 and 7021540 (2.88-1.91-1.33-1.00)		
Input	1304085022	19 T.
1st Gear	1304080004	34 T.
2nd Gear	1304080001	25 T.
3rd Gear	1304080019	21 T.
Cluster	1304077017	29-24-20-18 T. 2 Grooves + 2 Grooves
Rev. Gear - Slider	1304070002	39 T.
Rev. Idler	1304084005	16 T.
Rev. Assembly	1304584002	19 T.
Input - 5 I.D. Grooves		

Tooth Counts By Gear Number

1304000062 and 7021550 (2.88-1.74-1.33-1.00)		
Input	1304085022	19 T.
1st Gear	1304080004	34 T.
2nd Gear	1304080020	24 T.
3rd Gear	1304080019	21 T.
Cluster	1304077012	29-24-21-18 T. 1 Groove +1 Groove
Rev. Gear - Slider	1304070002	39 T.
Rev. Idler	1304084005	16 T.
Rev. Assembly	1304584002	19 T.
Input - 5 I.D. Grooves		

1304000071 and 7021560 (3.42-2.28-1.46-1.00)		
Input	1304085023	17 T.
1st Gear	1304080023	30 T.
2nd Gear	1304080021	25 T.
3rd Gear	T10U11	20 T.
Cluster	1304077016	31-25-20-16 T. 2 Grooves +1 Groove
Rev. Gear - Slider	1304070002	39 T.
Rev. Idler	1304084004	15 T.
Rev. Assembly	1304584002	19 T.
Input - 6 I.D. Grooves		

Richmond Super T10 Troubleshooting

ALL GEARS MISSING BUT SPEEDOMETER FUNCTIONS

- (1) Broken mainshaft or driveshaft yoke

ALL GEARS MISSING AND SPEEDOMETER DOES NOT FUNCTION

- (1) Broken maindrive or clutch

ALL INDIRECT GEARS MISSING/DIRECT GEAR PRESENT

- (1) Broken teeth on maindrive or countershaft cluster

ALL INDIRECT GEARS PRESENT/DIRECT GEAR MISSING

- (1) Broken clutching teeth on maindrive or sliding clutch

ONLY ONE GEAR MISSING/OTHERS PRESENT

- (1) Broken teeth on mainshaft gear or countershaft cluster
- (2) Broken clutching teeth on mainshaft gear or sliding clutch

TRANSMISSION LOCKED IN ALL GEARS

- (1) Worn or bent shift fork
- (2) Worn or broken synchronizer rings
- (3) Worn or broken detent spring
- (4) Worn or broken interlock

TRANSMISSION LOCKED IN ALL GEARS BUT ONE

- (1) Seized mainshaft gear

PERSISTENT MAINSHAFT OILSEAL LEAK

- (1) Worn universal joint
- (2) Bent or unbalanced driveshaft assy.
- (3) Worn mainshaft bushing

NOISE WITH THE TRANSMISSION IN NEUTRAL

- (1) Low oil level or improper oil used
- (2) Worn bearings
- (3) Worn countershaft thrust washers
- (4) Loose material in transmission
- (5) Worn or spread case

NOISE IN ALL GEARS (QUIETEST IN FOURTH)

- (1) Low oil level or improper oil used
- (2) Worn bearings
- (3) Broken or damaged maindrive or countershaft drive teeth

NOISE IN ONE OR MORE INDIRECT GEARS

- (1) Broken or damaged mainshaft gear or countershaft gear teeth
- (2) Broken or missing snaprings, washers, or spacers

GEAR CLASH IN SHIFTING

- (1) Clutch not releasing fully
- (2) Bound clutch pilot bushing or bearing
- (3) Worn synchronizer rings or mating gear cones
- (4) Worn or broken synchronizer struts
- (5) Broken or missing synchronizer rings

HARD SHIFTING

- (1) Worn or bent external shift linkage
- (2) Worn or broken synchronizer struts
- (3) Broken or missing synchronizer rings
- (4) Excessively heavy oil used

JUMPS OUT OF FOURTH (DIRECT) GEAR

- (1) Misaligned transmission case or clutch housing
- (2) Low oil level of improper oil used
- (3) Worn clutch pilot bearing or bushing
- (4) Worn clutching teeth or sliding clutch
- (5) Worn or broken detent spring
- (6) Worn or bent shift fork
- (7) Excessive maindrive endplay
- (8) Worn maindrive bearing

JUMPS OUT OF ONE OR MORE INDIRECT GEARS

- (1) Low oil level or improper oil used
- (2) Worn mainshaft pilot or pilot rollers
- (3) Worn clutching teeth or sliding clutch
- (4) Worn or broken detent spring
- (5) Worn or bent shift fork
- (6) Excessive mainshaft endplay
- (7) Worn mainshaft bearing

Richmond T10, 5 Speed & 6 Speed Transmission Speedo Parts List

GM PART NUMBERS LISTED BELOW

DRIVEN GEAR:	DRIVE GEAR:	DRIVEN GEAR HOLDER:
3987917 - 17T	361002 - 7T (GREEN)	345215
3987918 - 18T (BROWN)	6260705 - 8T (BLUE)	
3987919 - 19T (WHITE)	14038093 - 9T (WHITE)	HOLDER RETAINER:
3987920 - 20T (BLUE)		3708148
3987921 - 21T (RED)		
3987922 - 22T (BLACK)		BOLT:
3860346 - 23T		6264903 (1/4-20 X 1/2)
3860347 - 24T		
3860348 - 25T		

SPEEDOMETER GEAR RATIO FORMULA

$$\text{SPEEDOMETER GEAR RATION (SGR)} = \frac{63360 \times \text{AXLE RATIO}}{3141.6 \times \text{TIRE DIAMETER}}$$

EXAMPLE:

REAR AXLE RATIO = 3.08
REAR TIRE DIAMETER = 26"

$$\text{SGR} = \frac{63360 \times 3.08}{3141.6 \times 26} = 2.389$$

To determine speedometer gears required, multiply the number of teeth on the speedometer drive gear by SGR to determine the number of teeth required for the driven gear.*

*Richmond gear transmissions are supplied with an 8 tooth drive gear.

EXAMPLE:

SGR x 8 = Number of Driven Gear Teeth

2.389 x 8 = 19 Teeth on Driven Gear

NOTES

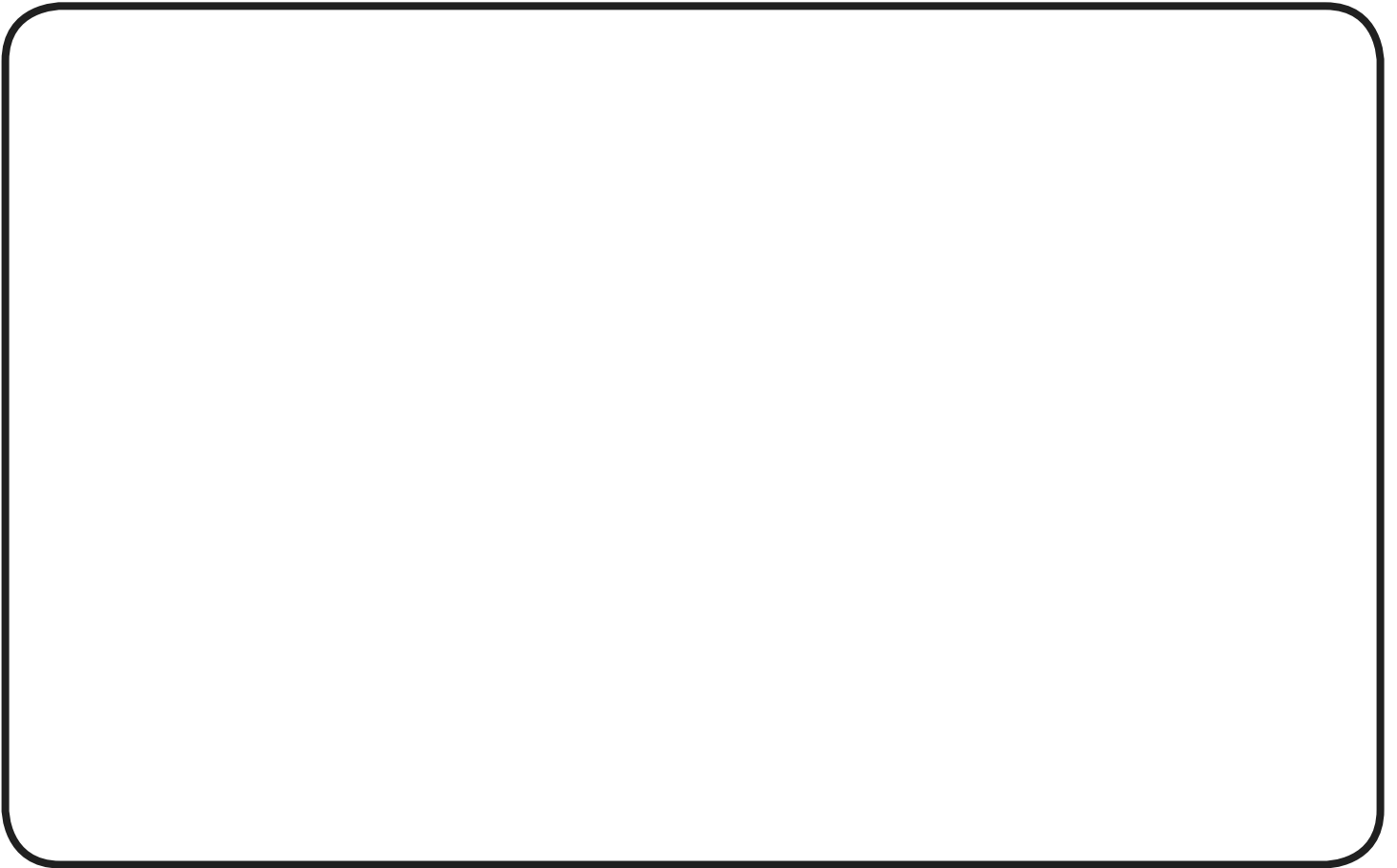

NOTES

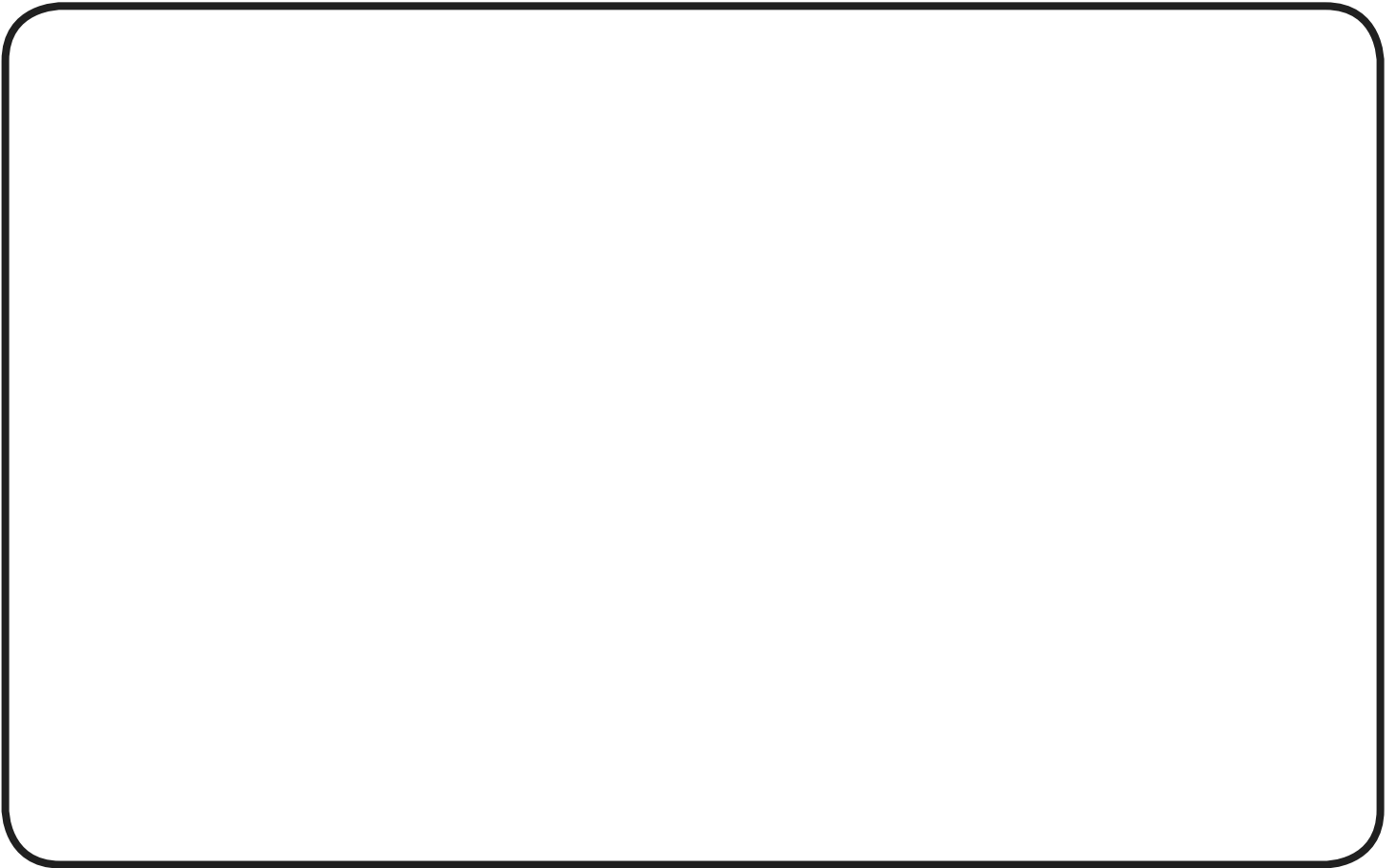



WINNER'S RUN RICHMOND!



Chicago, IL USA
Tech Line: 864-843-9275
Fax: 864-843-1276
Email: techsupport@richmondgear.com