



*70-81 Camaro
Rack & Pinion Steering System*



70-81 Camaro Rack & Pinion Cradle System

Index

For safety disconnect battery cables and ensure that vehicle is properly supported by jack stands.

NOTE: Hoses (FR1610) Pump Mounting Brackets (FR1611) is sold separately and is not included in this kit. Factory inner and outer tie rod ends must be used with this rack and pinion kit.

Before paint or powder coating of the rack and pinion cradle system we recommend that you pre-fit the system to ensure proper fit.

Installation hardware and inventory	PG 2
Electrical System Verification (Only if using a Flaming River Column)	PG 3
Removal of Factory Steering Shaft	PG 3
Removal of Factory Steering Column (Only if using a Flaming River Column)	PG 4
Steering Box & Linkage Removal	PG 4-5
Installation of Flaming River Column (For kits including new Column)	
Installation of New Flaming River Tilt Column	PG 6
Electrical System Notes	PG 7
Steering Wheel Installation	PG 7-8

Installation of the Flaming River Rack & Cradle

Installation of Rack and Cradle	PG 8-10
Section 4 Universal Joint Installation	
A. Universal Joint and Steering Shaft Installation	PG 10-11
Torque Specs	PG 11

Warranty Disclaimer

Because of their intended usage, the manufacturer makes no warranties whatsoever express or implied, oral or written, to purchasers of their products regarding performance, safety, fit merchantability, or length of service. Purchasers are responsible for selection of proper goods and must rely on there own skill or judgment that such goods are suitable for purchasers application.

70-81 Camaro Rack & Pinion Cradle System

P/N	DESCRIPTION	QTY
100202	KIT, HDW CRADLE CAMARO 70-81	1
100205	ASM, JOINT HEIM Ø.75 MODIFIED	1
100207	ASM, CRADLE CAMARO 1970-81	1
FR1614	REMOTE RESEVOIR-PWR STEERING	1
FR1717DD	3/4DD X 1DD	1
FR1789P-2	FR POWER X 3/4DD	1
FR1850-22	22" 3/4DD SHAFT	1
FR20114-K	FACTORY DROP	1
FR20118	FEMALE CONNECTOR KIT	1
FR2644	FORGED U-JOINT 3/4DD X 3/4DD	1
FR30001	33" KEY COLUMN PAINT	1
FRDMDCL	FR DOMED DECAL	1
FRPMSB-V	PUMP W/V-BELT PULLY ON	1

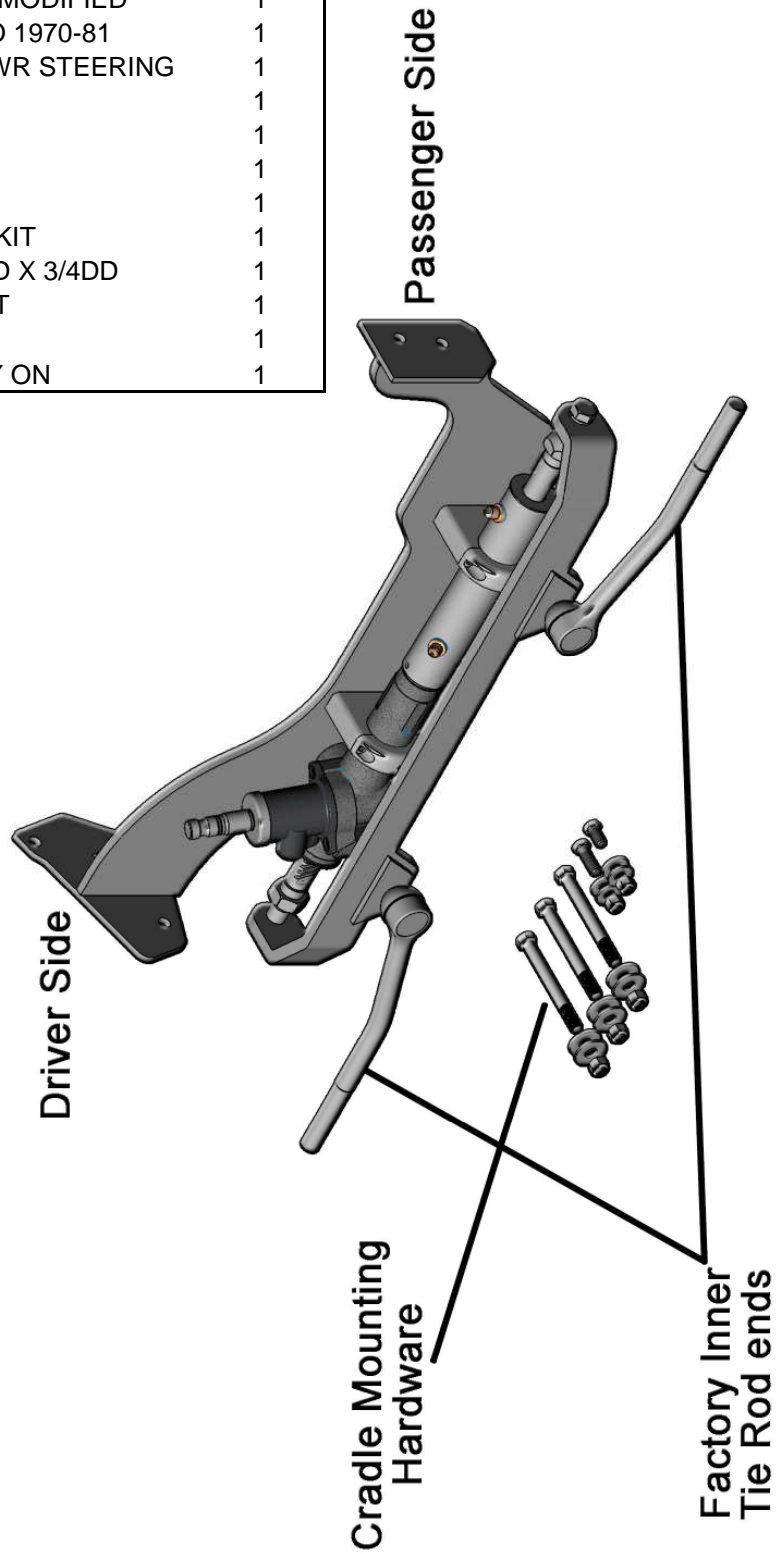
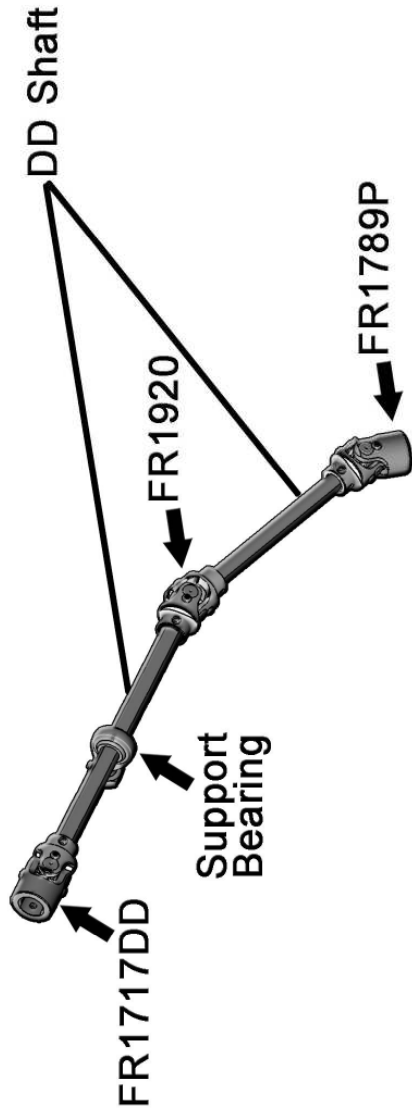

70-81 Camaro Rack & Pinion Cradle System

If using a Flaming River Steering Column it is recommended that before any disassembly you should first verify the wiring for your turn signals and ignition switch to ensure proper operation.

Color Verification to be completed before disassembly

Before disconnecting the turn signal and the ignition connectors verify the wiring color to ensure proper operation. The colors listed with the ignition switch diagram below are from a stock wiring system. Wire colors may change due to the use of aftermarket wiring harnesses and wiring modifications. The use of a wiring diagram is recommended.

- Brake Light Switch : _____
- RR Turn Signal : _____
- LR Turn Signal : _____
- Turn Signal Power : _____
- Hazard Power : _____
- RF Turn Signal : _____
- LF Turn Signal : _____
- Horn : _____

Original Steering Shaft Removal

- 1) Remove the pinch bolt that retains the steering coupler to the steering column and the bolt that retains the rag joint to the steering box. Collapse shaft and remove it from the car.

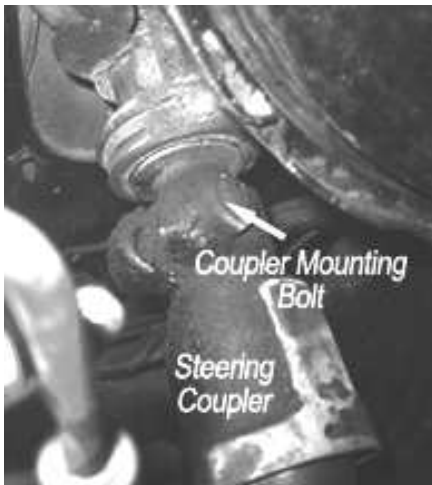

70-81 Camaro Rack & Pinion Cradle System

Original Column Removal

Only perform these steps if using a new Flaming River Steering Column

- 1) Disconnect the column wiring connectors.
- 2) Remove the bolts that hold the column floor mount to the firewall.
- 3) Support the column and remove the bolts that retain the under dash mounting clamp.
- 4) Remove the factory steering column from the vehicle.



Steering Box and Linkage Removal

Before beginning you must first measure the width of your front end from LEFT outer tie rod end zerk to the RIGHT outer tie rod end zerk to determine the overall width of your front end. Write dimension here for further reference _____

- 1) Remove the pitman arm from the steering box using a pitman arm puller.



- 2) Remove the two bolts that retain the idler arm to the frame rail.



70-81 Camaro Rack & Pinion Cradle System

- 3) Remove the cotter pins and castle nuts and separate the outer tie rod ends from the spindles.

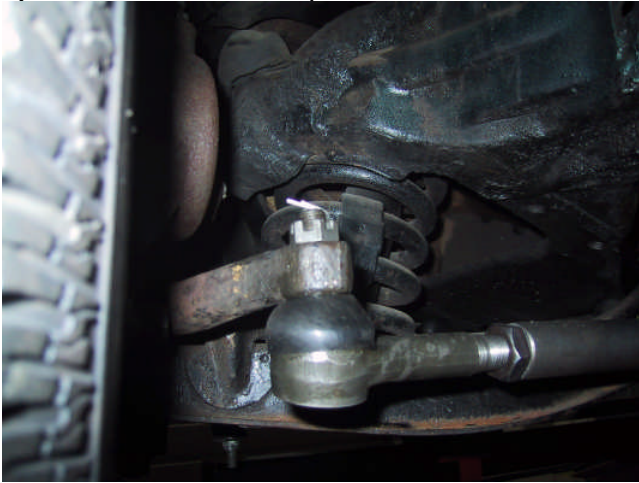

- 4) Next remove the steering linkage from the car.



- 5) If you have power steering remove the lines from your power box, pump and pump brackets.
6) Remove the three bolts that retain the box to the frame rail and remove the box from the car



70-81 Camaro Rack & Pinion Cradle System

Installation of Flaming River Column

Note: The factory OEM floor mount is fixed to the steering column. Modification to the factory floor mount is required to hold the new steering column in place. (See example below)

- 1) Remove the two screws that hold the dash mount together and separate.

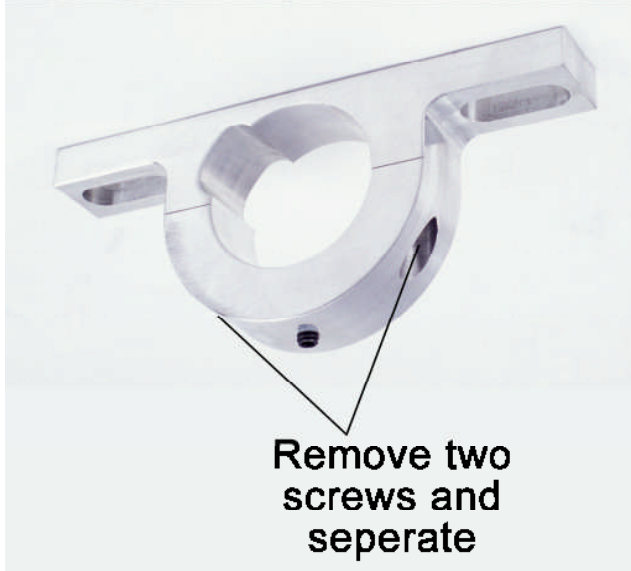

- 2) Take the upper portion of the mount and place it in the stock mounting location, next using the factory mounting hardware snug the mount in place.
- 3) Place the modified factory floor mount over the column tube.
- 4) Hold the new column into the mounting location and reattach the lower portion of the dash mount bracket.
- 5) Ensure that the column straight by having the turn signal arm points to the 9 o'clock position. Tighten the two mounting screws on the new Flaming River clamp.
- 6) Install the floor mounting screws and tighten to 15 ft lbs.
- 7) Tighten the floor mounting clamp around the tube.

Note: Floor Mount and parts to modify the factory floor mount are not included



70-81 Camaro Rack & Pinion Cradle System

Electrical System Notes

Caution: Before disconnecting your original steering column wiring harness please verify each wire color and function on the worksheet below. Some wire colors may vary from year to year.

FLAMING RIVER COLUMN WIRING

P-WHITE-BRAKELIGHT SWITCH
N-DK GREEN-RR TURN SIGNAL
M-YELLOW-LR TURN SIGNAL
L-PURPLE-TURN SIGNAL POWER
K-BROWN-HAZARD POWER
J-DK BLUE-RF TURN SIGNAL
H-LT BLUE-LF TURN SIGNAL
G-BLACK-HORN

Color Verification to be completed before disassembly

- Brake Light Switch : _____
- RR Turn Signal : _____
- LR Turn Signal : _____
- Turn Signal Power : _____
- Hazard Power : _____
- RF Turn Signal : _____
- LF Turn Signal : _____
- Horn : _____

Steering Wheel Installation

- 1) Install horn contact kit into canceling cam tube and turn to lock.

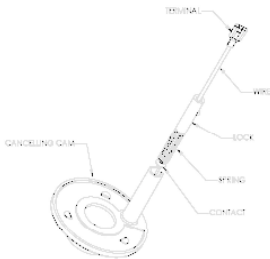

- 2) Align steering wheel adapter so that the canceling cam hole is at approx the 11 o'clock position and that one of the steering wheel mounting holes is at the 12 o'clock position.

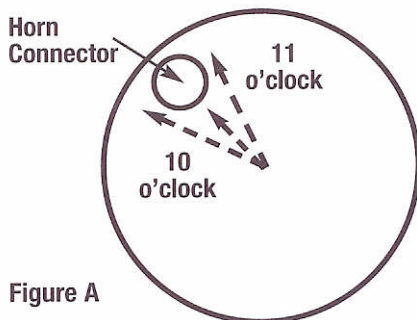
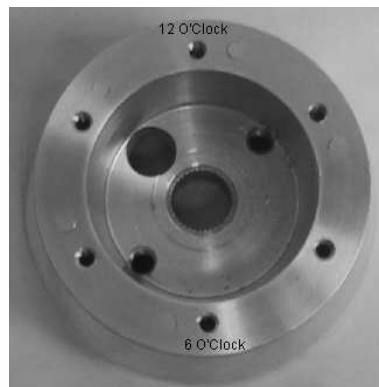
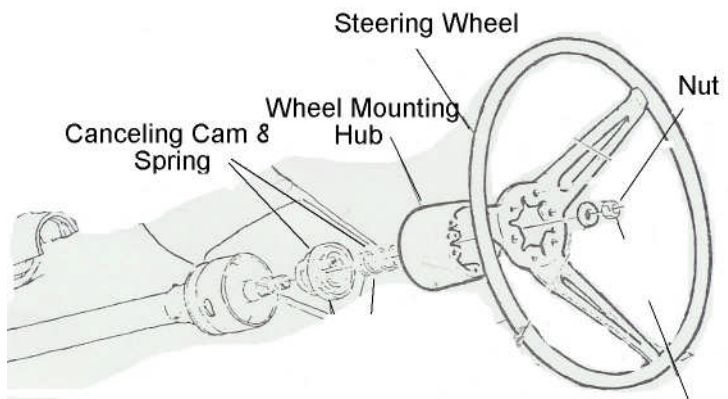

Figure A



70-81 Camaro Rack & Pinion Cradle System

- 3) To install the wheel adapter run the horn contact wire through the hole for the canceling cam and place the adapter on to the splined column shaft.
- 4) Tighten the adapter-retaining nut until the adapter is approximately 1/16" away from the column shroud.



Installation of the Flaming River Rack and Cradle

- 1) Install the rack and pinion cradle by sliding it into place between the frame rails, installing the new hardware using three 7/16" bolts where the gear box was mounted and two 3/8" bolts where the idler arm was located. Tighten the 7/16" nuts and bolts to 50-65 ft lbs and the 3/8" nuts and bolts to 40 -45 ft lbs.

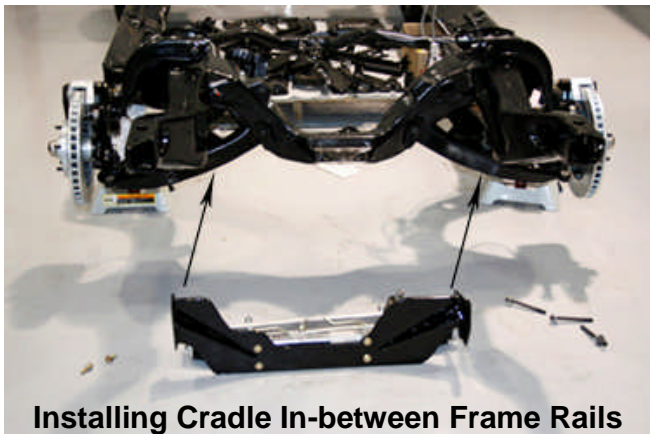

70-81 Camaro Rack & Pinion Cradle System

- 2) To install the Flaming River rack and travel bar system rotate the travel bar over the lip of the cross member, next position the rack into place and install the rack to the cradle using the mounting brackets provided. Once you have adjusted the pinion angle tighten the 4 mounting bracket bolts and the 2 ¼-20 set screws to lock the rack in place.

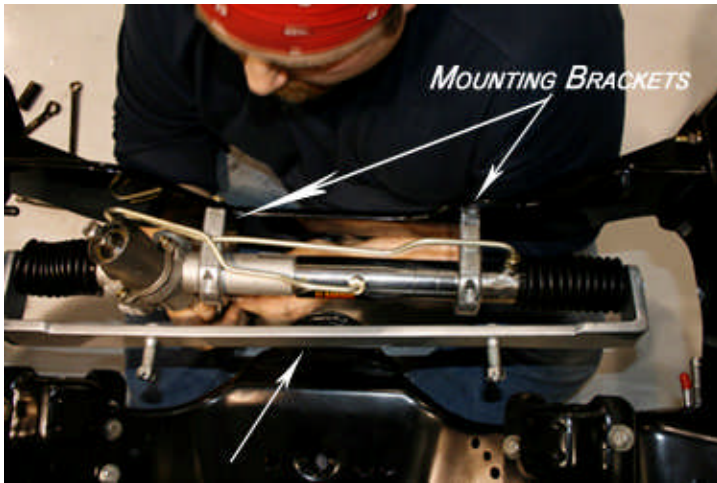

- 3) Install the inner and outer tie rod assembly into the travel bar assembly and adjust tie rods until the original zerk to zerk measurement taken before disassembly is obtained.

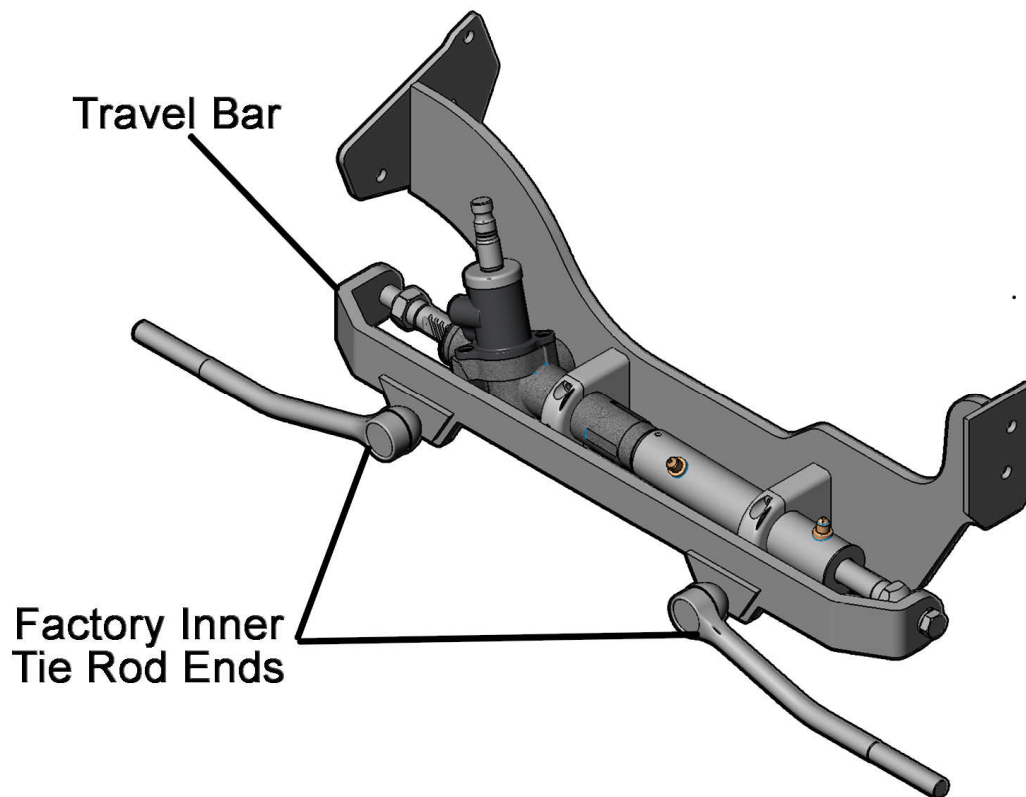

70-81 Camaro Rack & Pinion Cradle System

- 4) To install the outer tie rod ends into the spindles you must load the front suspension. (Securely placing jack stands under the lower control arms and lowering the car onto the jack stands accomplishes this.) Install the outer tie rod ends into the spindle and tighten the castle nuts to 30-40 ft lbs. Make sure to install cotter pins into the castle nut and tie rod end and bend the tabs over for security.



Universal Joint System.

- 1) Install support-bearing mount onto the rear control arm bolt; after the shafting is installed make sure to tighten the set screw.

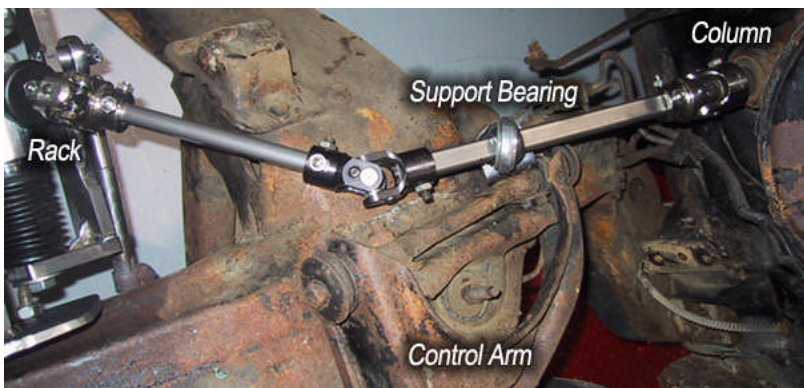

70-81 Camaro Rack & Pinion Cradle System

- 2) We recommend the use of $\frac{3}{4}$ " wood dowel rod to mock up the steering shaft to obtain the correct length of the shafts.
- 3) Install your shaft kit and snug each set screw so that it will leave a mark in the shafts.
- 4) Remove shaft and dimple each setscrew mark using a $\frac{1}{4}$ " drill bit. (As shown below.)

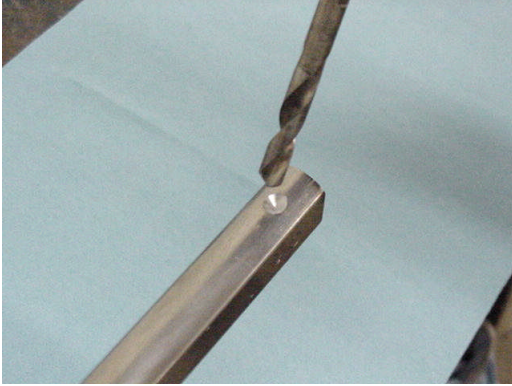

- 5) Re-install the shafts using **red loc-tite thread locker** on the set screw threads. Tighten each setscrew to 25 ft. lbs. Tighten all lock nuts securely. We recommend that you inspect setscrews periodically for tightness.

Torque Specs

Cradle to Frame Mounting Bolts

7/16" Mounting Bolts	50-65 ft lbs
3/8" Mounting Bolts	40-45 ft lbs

Outer Tie Rod Ends to Spindle 30-40 ft lbs

Universal Joint Set Screws 25 ft-lbs