

Installation Instructions

I - Sheet Number VS13 Rev.A



AUTO VENT SHADE™

Ventshade® Deflector

For proper installation and best possible fit, please read all instructions **BEFORE** you begin.
For technical assistance or to obtain missing parts, please call Customer Relations at 1-800-241-7219.

Important Safety Information



- CAUTION - Before driving, ensure that the vent visor is properly secured to vehicle.
- Do not use automatic "brush-style" car washes.
- Do not use cleaning solvents of any kind.
- Periodically check all components for tightness.

Contents - 2 Piece Set

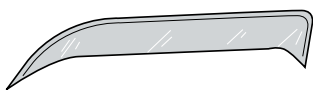

Front Driver Side Visor

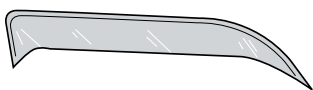

Front Passenger Side Visor



GP-1 Clip x 8

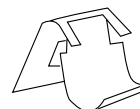

GM-3 Clip x 8

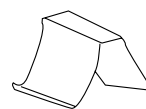

GM-4 Clip x 2

Tools Required



Car Wash Supplies



Clean Towel



Pencil

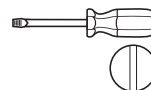

Flathead Screwdriver

Preparation Before Painting / Installation

- A trial fit is recommended to ensure proper positioning and fit.
- Check fit of parts before painting as we will not accept the return of modified or painted parts.
- Wash and dry your vehicle to remove any debris and/or dirt from the installation area.

Installation Steps

NOTE: Actual application may vary slightly from illustrations.

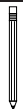

Lower window. Use a pencil to mark clip installation locations on rubber trim as shown. **Two-piece clip** locations are indicated by white triangles; the location of the **one-piece clip** (one inch down from the top) is indicated by black triangle.

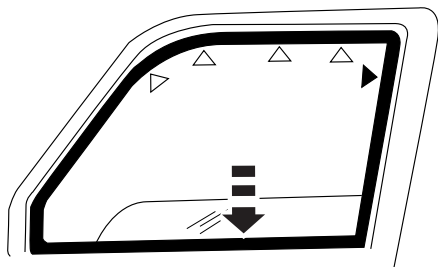

1

The rubber window channel has weather seals which press against the window when it is rolled up. Pull one of the seals down with thumb at one of the two-piece clip locations.

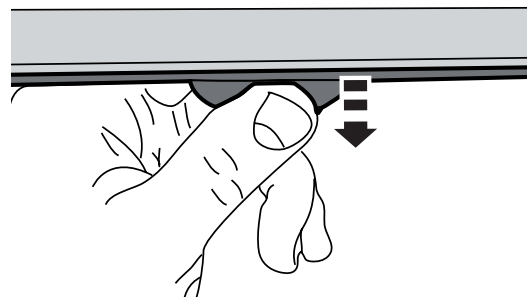

2

Installation Steps

NOTE: Actual application may vary slightly from illustrations.

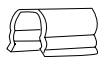

Insert a GP-1 clip as shown. Push it all the way up into the window channel, then release seal with thumb. Pull the other window seal out from under the clip to seat it properly. See cross section.

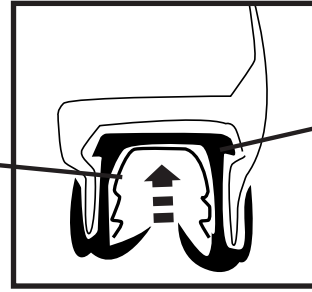
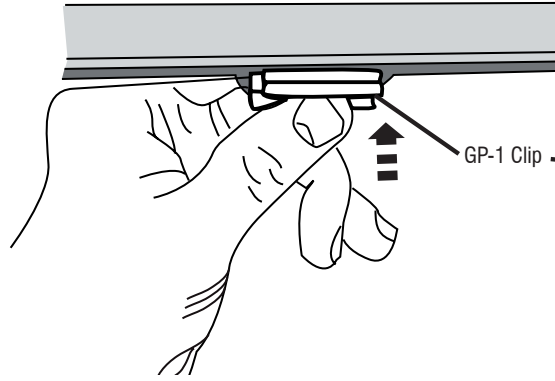

Rubber Window Channel

GP-1 Clip

CROSS SECTION

3

Place flange of deflector into rubber cavity of window. Figure 4 shows deflector in position. See cross section of deflector flange in the window channel.

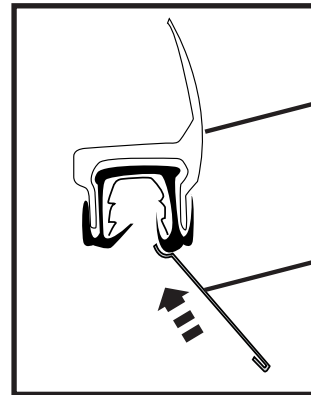
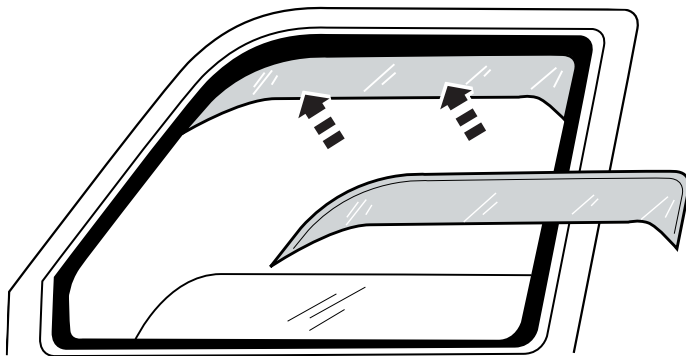

Outside of Door Frame

Deflector

CROSS SECTION

4



Install the GM-3 components of the two-part clips into the GP-1 parts installed in **Steps 1-3**. Use a screwdriver to push the GM-3 clips up into place. **NOTE: The barbs on the GM-3 clip must lock into place in the GM-1 clip, so it is very important that they are installed at the proper locations, as marked in Step 1.**

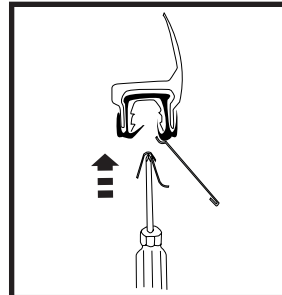
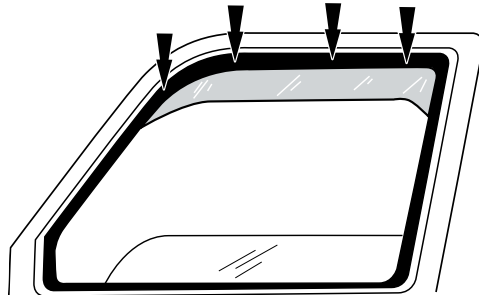
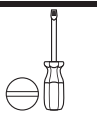

CROSS SECTION

5

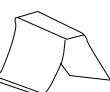

Place GM-4 clip at the rear of the deflector, with the curved bottom of foot facing outward. **NOTE:** there should be a one-inch gap between top of clip and bottom edge of top of window frame. Seat the clip by pushing it back into the channel with a screwdriver.

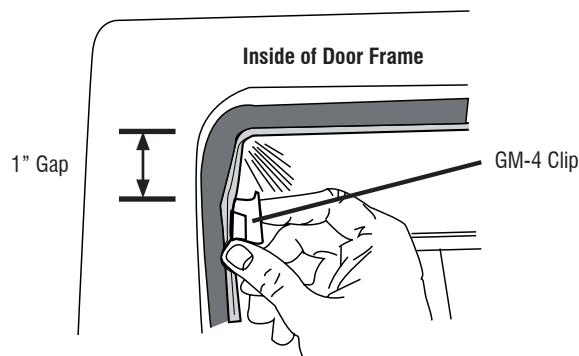
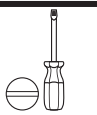

Inside of Door Frame

1" Gap

GM-4 Clip

6

Installation Steps

NOTE: Actual application may vary slightly from illustrations.

Repeat **Steps 1-6** for opposite side

Care and Cleaning

- Wash only with mild soap & dry with a clean cloth.

Congratulations!

You have purchased one of the many quality Auto Ventshade™ branded products offered by Lund International, Inc. We take the utmost pride in our products and want you to enjoy years of satisfaction from your investment. We have made every effort to ensure that your product is top quality in terms of fit, durability, finish and ease of installation.



Lund International, Ventshade Accessories Division
655 Raco Drive, Lawrenceville, GA 30045

800-241-7219 • Fax 770-339-5839 • Visit us at lundinternational.com

© 2006 Lund International, Inc. All rights reserved.

Auto Ventshade™, the Auto Ventshade™ logo and the AVS™ logo are trademarks of Lund International, Inc.





Ventshade® Deflector

Pour obtenir une installation correcte et le meilleur ajustement possible, lire toutes les instructions **AVANT** de commencer.
 Pour toute assistance technique ou obtention de pièces manquantes, appeler le service des relations avec la clientèle au
1-800-241-7219.

Informations importantes concernant la sécurité



- **ATTENTION** – Avant de conduire, s'assurer que la visière est solidement assujettie sur le véhicule.
- Ne pas utiliser les stations de lavage de voitures à brosses.
- Ne pas utiliser de solvants.
- Vérifier régulièrement le serrage des composants.

Contenu - Ensemble 2 pièces

NOTE: Le produit réel peut changer de l'illustration.

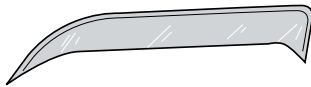

Visière avant côté conducteur

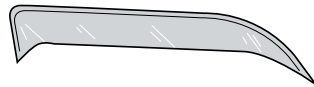

Visière avant côté passager

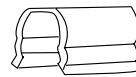

GP-1 Attache (8)

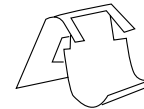

GM-3 Attache (8)

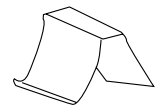

GM-4 Attache (2)

Outils nécessaires



Fournitures pour lavage de voiture



Serviette propre

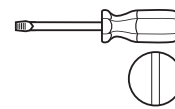

Tournevis de Flathead

Préparation pour la peinture/l'installation

- Il est recommandé de procéder à un essai pour s'assurer que le positionnement et l'ajustement sont corrects.
- Vérifier l'ajustement des pièces avant peinture, car nous n'acceptons pas le retour de pièces modifiées ou peintes.
- Laver les glissières de glaces de la portière du véhicule pour éliminer toute poussière et tous débris.
- Sécher les glissières avec une serviette propre.

Étapes d'installation

REMARQUE : La méthode d'application peut être légèrement différente de celle représentée par les illustrations.



Abaisser la glace. À l'aide d'un crayon, marquer sur la garniture en caoutchouc les emplacements d'installation des clips, comme illustré. L'emplacement des **clips deux pièces** est indiqué par les triangles blancs, et celui du **clip une pièce** (à 2,5 cm [1 po] du haut) est indiqué par le triangle noir.

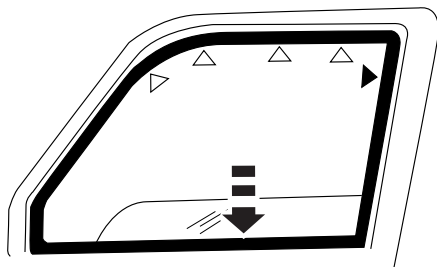

1

La glissière en caoutchouc de la glace est dotée de joints d'étanchéité qui font pression contre la glace lorsqu'elle est relevée. À l'un des emplacements des clips deux pièces, tirer l'un des joints vers le bas avec le pouce.

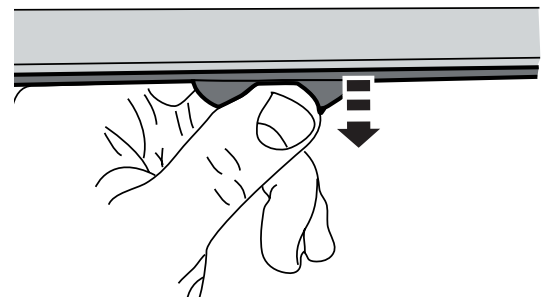

2

Étapes d'installation

REMARQUE : La méthode d'application peut être légèrement différente de celle représentée par les illustrations.

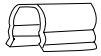

Insérer un clip GP-1 comme illustré. L'enfoncer complètement dans la glissière de la glace, puis relâcher le joint avec le pouce. Tirer l'autre joint de la glace pour le sortir du dessous du clip, pour bien le mettre en place. Voir la coupe transversale.

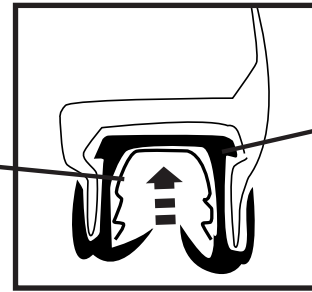
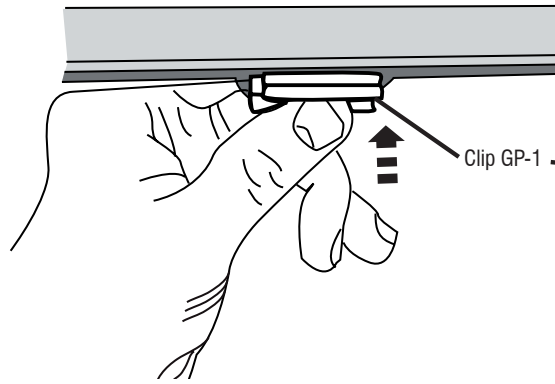

Glissière en caoutchouc de la glace

COUPE TRANSVERSALE

3

Placer le rebord du déflecteur dans la cavité en caoutchouc de la glace. La figure 4 illustre le déflecteur en place. Voir la coupe transversale du rebord du déflecteur en place dans la glissière de glace.

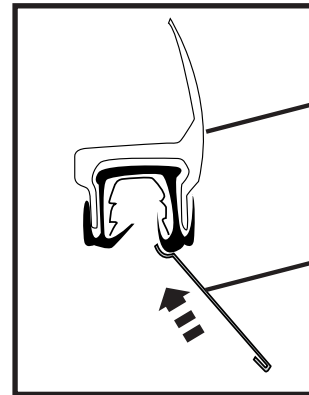
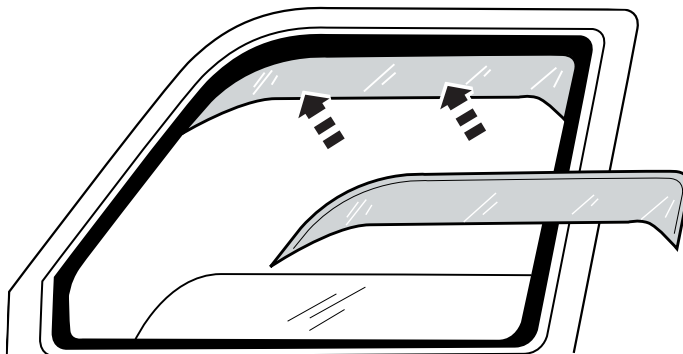

Extérieur du cadre de portière

Déflecteur

COUPE TRANSVERSALE

4

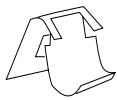

Installer les composants GM-3 des clips deux pièces dans les pièces GP-1 installées aux étapes 1 à 3. Mettre les clips GM-3 en place en les poussant vers le haut à l'aide d'un tournevis. **REMARQUE :** Les barbelures du clip GM-3 doivent se bloquer en place dans le clip GM-1. Il est donc très important de les installer aux bons emplacements, qui ont été marqués à l'étape 1.

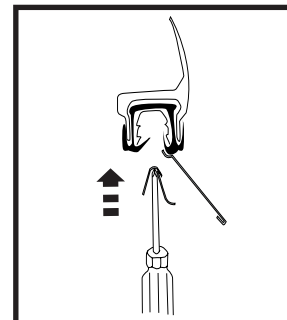
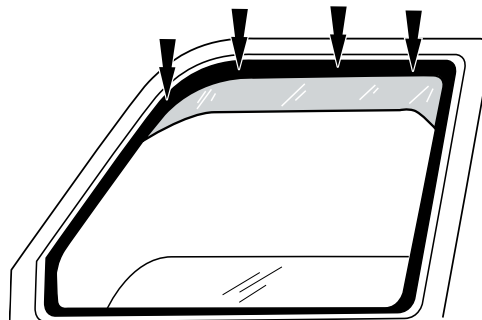
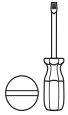

COUPE TRANSVERSALE

5

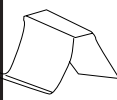

Placer le clip GM-4 à l'arrière du déflecteur, avec la partie inférieure incurvée de la patte orientée vers l'extérieur. **REMARQUE :** il doit y avoir un écart de 2,5 cm (1 po) entre le haut du clip et le rebord inférieur du haut du cadre de glace. Bien mettre le clip en place en le poussant dans la glissière à l'aide d'un tournevis.

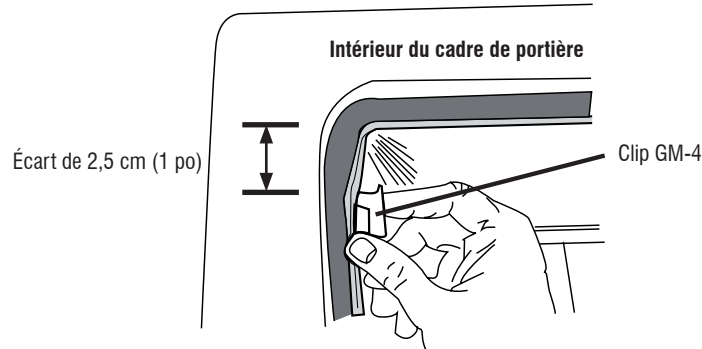
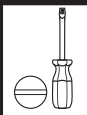

Intérieur du cadre de portière

Écart de 2,5 cm (1 po)

Clip GM-4

6

Répéter **les étapes 1 à 6** pour les autres glaces

Entretien et nettoyage

- Laver exclusivement avec de l'eau savonneuse et sécher avec un chiffon propre.

Félicitations !

Vous avez acheté l'un des nombreux produits de qualité Auto Ventshade™ fabriqués par Lund International, Inc. Nous sommes extrêmement fiers de nos produits et souhaitons que vous tiriez des années de satisfaction de votre investissement. Nous avons pris toutes les mesures nécessaires pour assurer que ce produit est d'une qualité supérieure en ce qui concerne l'ajustement, la durabilité, la finition et la facilité d'installation.



AUTO VENTSHADE™

Lund International, Ventshade Accessories Division

655 Raco Drive, Lawrenceville, GA 30045, USA

800-241-7219 • Fax 770-339-5839 • Visitez notre site lundinternational.com



© 2006 Lund International, Inc. Tous droits réservés.
Auto Ventshade™, le logo Auto Ventshade™ et le logo AVS™ sont des marques déposées de Lund International, Inc.





Ventshade® Deflector

Para una instalación adecuada y el mejor ajuste posible, lea todas las instrucciones ANTES de comenzar. Si desea recibir asistencia técnica u obtener piezas faltantes, llame al Servicio al cliente al 1-800-241-7219.

Información importante de seguridad



- **PRECAUCIÓN** - Antes de conducir, asegúrese de que la visera esté correctamente anclada al vehículo.
- No utilice servicios automáticos de limpieza de vehículos que utilizan cepillos.
- No utilice limpiadores al solvente de ningún tipo.
- Compruebe periódicamente que todos los componentes estén ajustados.

Contenido - Juego de dos piezas

NOTA: El producto real puede variar de la ilustración.

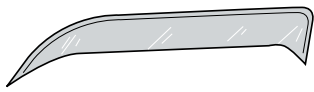

Visera delantera del conductor

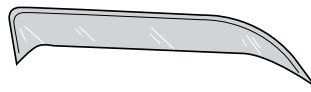

Visera delantera del acompañante

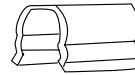

GP-1 Sujetador x 8

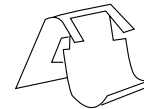

GM-3 Sujetador x 8

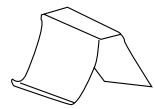

GM-4 Sujetador x 2

Herramientas necesarias



Equipo de limpieza de vehículos



Toalla limpia

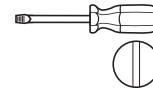

Destornillador de cabeza llana

Preparación antes de pintar o instalar

- Se recomienda realizar un ajuste de prueba para asegurar el posicionamiento y ajuste correctos.
- Compruebe que las piezas se ajusten correctamente antes de pintarlas, ya que no aceptaremos la devolución de piezas modificadas o pintadas.
- Lave los canales de la ventanilla del vehículo para quitar los desechos y la suciedad.
- Seque los canales de la ventanilla con una toalla limpia.

Pasos de instalación

AVISO: La colocación real puede variar con respecto a las ilustraciones.



Baje la ventanilla. Utilice un lápiz para marcar las ubicaciones de las presillas para su instalación en la banda de goma, como se indica. Las ubicaciones de las **presillas de dos piezas** se indican con los triángulos blancos; la ubicación de la **presilla de una pieza** (una pulgada por debajo de la parte superior) se indica con el triángulo negro.

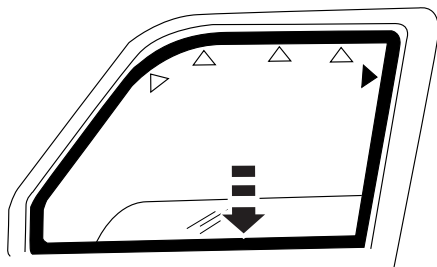

1

2

El canal de goma de la ventanilla cuenta con burletes que se presionan contra la ventanilla al subirla. Baje uno de los burletes con el pulgar en una de las ubicaciones de las presillas de dos piezas.

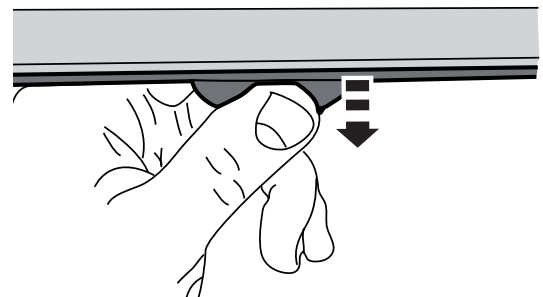

Pasos de instalación

AVISO: La colocación real puede variar con respecto a las ilustraciones.

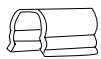

Inserte una presilla GP-1 como se indica. Colóquela presionando hasta el fondo dentro del canal de la ventanilla, luego libere el burlete con el pulgar. Retire el otro burlete de la ventanilla desde abajo de la presilla para asentarla correctamente. Consulte la vista de corte transversal.

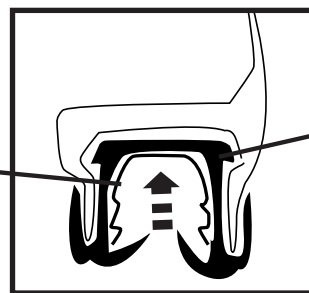
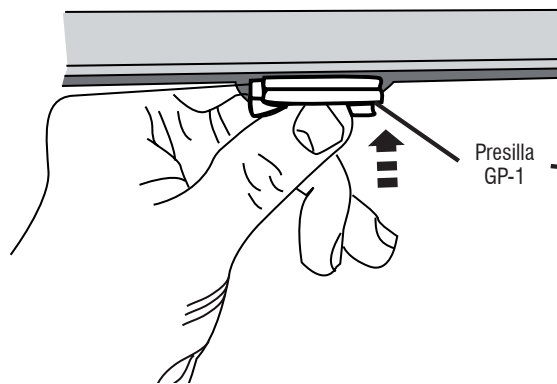

VISTA DE CORTE TRANSVERSAL

3

Coloque el reborde del deflector en la cavidad de goma de la ventanilla. La figura 4 muestra el deflector en su lugar. Consulte la vista de corte transversal del reborde del deflector en el canal de la ventanilla.

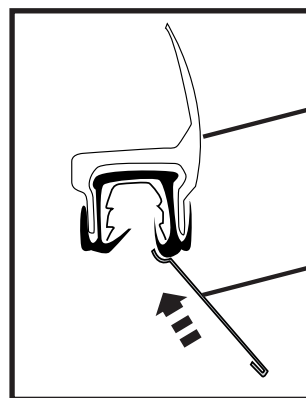
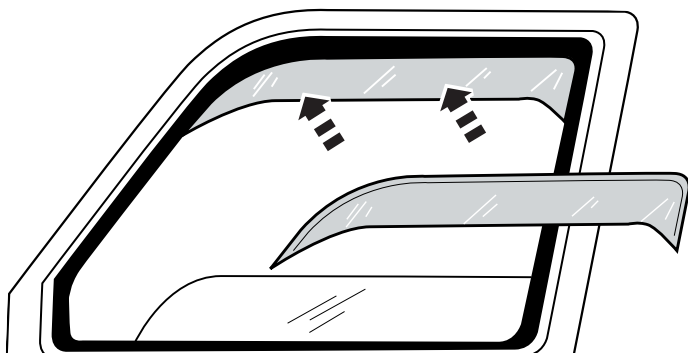

Parte exterior del marco de la puerta

Deflector

VISTA DE CORTE TRANSVERSAL

4



Instale los componentes GM-3 de las presillas de dos piezas en las partes GP-1 instaladas según los **pasos 1 a 3**. Utilice un destornillador para colocar las presillas GM-3 en su lugar. **AVISO:** Las púas de las presillas GM-3 deben trabarse en su lugar en las presillas GM-1, por lo que es muy importante que estén instaladas en las ubicaciones correspondientes, como se indica en el paso 1.

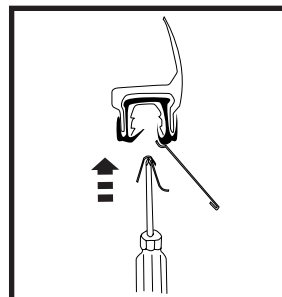
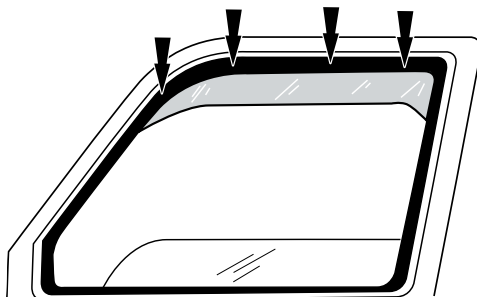

VISTA DE CORTE TRANSVERSAL

5



Coloque la presilla GM-4 en la parte trasera del deflector, con la parte inferior curva de la base apuntando hacia afuera. **AVISO:** debe haber un espacio de una pulgada entre la parte superior de la presilla y el borde inferior de la parte superior del marco de la ventanilla. Asiente la presilla presionándola otra vez dentro del canal con un destornillador.

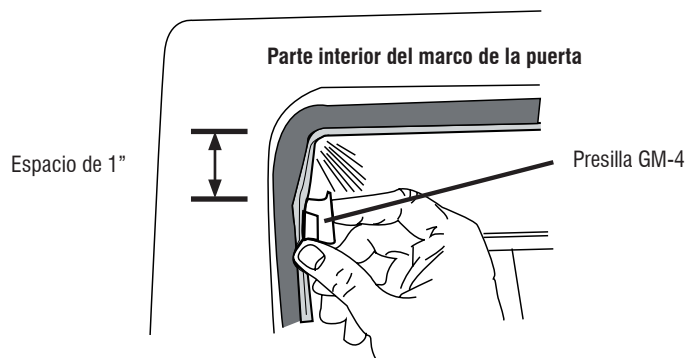
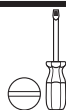

6

Repita **los pasos del 1 al 6** para las
ventanillas restantes

Cuidado y limpieza

- Limpie solamente con agua jabonosa tibia y seque con un paño limpio.

Felicidades

Usted ha comprado uno de los tantos artículos de calidad de Auto Ventshade™ ofrecidos por Lund International, Inc. Nuestros productos son nuestro mayor orgullo. Deseamos que disfrute de años de satisfacción con su inversión. Hemos realizado todos los esfuerzos para asegurarnos de que su producto sea de la mejor calidad en cuanto a ajuste, durabilidad, acabado y facilidad de instalación.



AUTO VENTSHADE™

Lund International, Ventshade Accessories Division

655 Raco Drive, Lawrenceville, GA 30045

800-241-7219 • Fax 770-339-5839 • Visite nuestro sitio Web: lundinternational.com



© 2006 Lund International, Inc. Todos los derechos reservados.

Auto Ventshade™, el logo de Auto Ventshade™ y el logo de AVS™ son marcas comerciales de Lund International, Inc.

