



# INSTRUCTIONS—INSTRUCCIONES—CONSIGNES

APPLICATION: 2007-UP JEEP WRANGLER  
APP PART # 46-23635  
MAX WINCH TRAY

AUTOMOTIVE PRODUCTS, INC.

ITEM	QUANTITY	DESCRIPTION	TOOLS NEEDED
1	1	WINCH TRAY	18MM WRENCH
2,3	2	FRONT MOUNTING BRACKETS (2) DRIVERS SIDE, (3) PASSENGER SIDE	18MM SOCKET
4,5	2	FRAME MOUNTING BRACKETS (4) DRIVERS SIDE, (5) PASSENGER SIDE	RATCHET
6	2	M12 NUT PLATES	TORQUE WRENCH
7	2	M12 x 40MM HEX HEAD BOLT	
8	2	M12 X 30MM HEX HEAD BOLT	
9	8	M12 X 24MM OD FLAT WASHERS	
10	4	M12 X 37MM OD FLAT WASHERS	
11	12	M12 LOCK WASHERS	
12	8	M12 HEX NUT	
13	6	M12 HEX HEAD BOLTS (BLACK ZINC)	
14	6	M12 FLAT WASHERS (BLACK ZINC)	
15	6	M12 LOCK WASHERS (BLACK ZINC)	

1. Remove all contents from box, verify all parts listed are present and free from damage. Carefully read and understand all instructions before attempting installation.
2. Starting at the front of the vehicle locate all fasteners attaching the front bumper to the frame. Remove the bumper and set aside.
3. With the bumper removed, remove the metal frame from inside the bumper, there are 4 factory bolts fastening the frame to the plastic shell. Once the metal frame is removed, remove the factory tow hooks which are wedged between the metal frame and plastic bumper shell. NOTE: the factory tow hooks will not be reused (FIG 1).
4. Take the front mounting brackets and install them in the factory tow hooks place (FIG 2). NOTE: On 2wd models, the plastic bumper shell will not have the tow hook hole but an indent in the plastic shell cut these indents out to allow the front mounting bracket to be installed. Re assemble the metal frame to the plastic bumper shell and set aside.
5. Locate the M12 nut plates and insert them into the inside frame pocket shown in (FIG 3).
6. Locate the frame mounting brackets and attach them to the previously installed nut plates. To mount the bracket to the top nuts use (2) M12 x 30mm hex head bolts, (2) M12 x 37mm flat washers, and (2) M12 lock washers, to mount to the bottom nuts use, (2) M12 x 40mm hex head bolts, (2) M12 x 37mm flat washers, and (2) M12 lock washers. Do not fully tighten at this time (FIG 4).
7. Take the bumper assembly and attach it back onto the vehicle. The two inside bolts will go through the frame and the frame mounting brackets. Attach the bumper assembly using, (8) M12 x 24mm flat washers, (8) M12 lock washers, and (8) M12 hex nuts. Do not fully tighten at this time (FIG 5).
8. Once the bumper is installed (FIG 6), locate the winch tray and place it on top of the frame between the bumper and grille, align the winch tray with the frame mounting brackets and the front mounting brackets, attach the winch tray to the frame and front mounting brackets using (6) M12 hex head bolts (black zinc), (6) M12 lock washers (black zinc), and (6) M12 flat washers (black zinc) (FIG 7). Do not fully tighten at this time.
9. Align and adjust winch tray as needed then fully tighten all hardware at this time. Torque all M12 fasteners to 50-55 ft lbs



Westing Automotive Products, Inc.  
5200 N. Irwindale Ave. Suite 220  
Irwindale, Ca. 91706

Thank You for choosing Westin products  
For Additional installation assistance please call  
Customer service (800) 793-7846  
[www.westinautomotive.com](http://www.westinautomotive.com)

**CARE INSTRUCTIONS**

- REGULAR WAXING IS RECOMMENDED. DO NOT USE ANY TYPE OF POLISH OR WAX THAT MAY CONTAIN ABRASIVES
- STAINLESS STEEL PRODUCTS CAN BE CLEANED WITH MILD SOAP AND WATER. STAINLESS STEEL POLISH SHOULD BE USED TO POLISH SMALL SCRATCHES.
- GLOSS BLACK FINISHES SHOULD BE CLEANED WITH MILD SOAP AND WATER

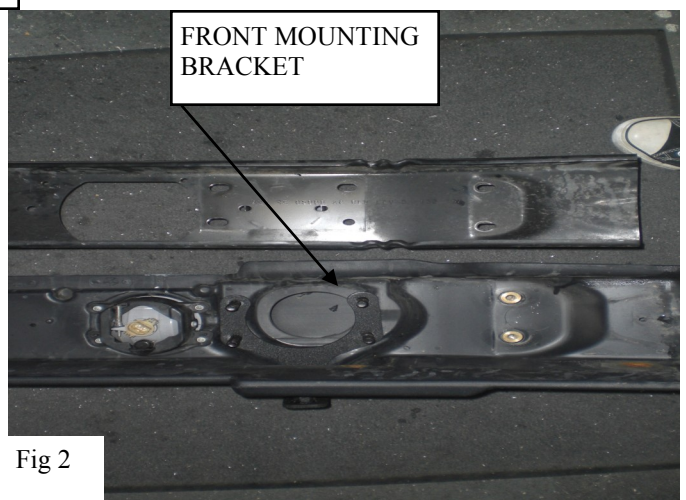
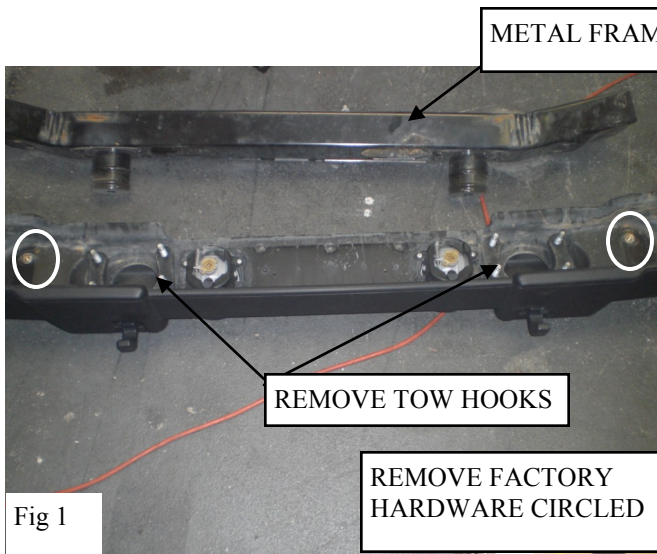
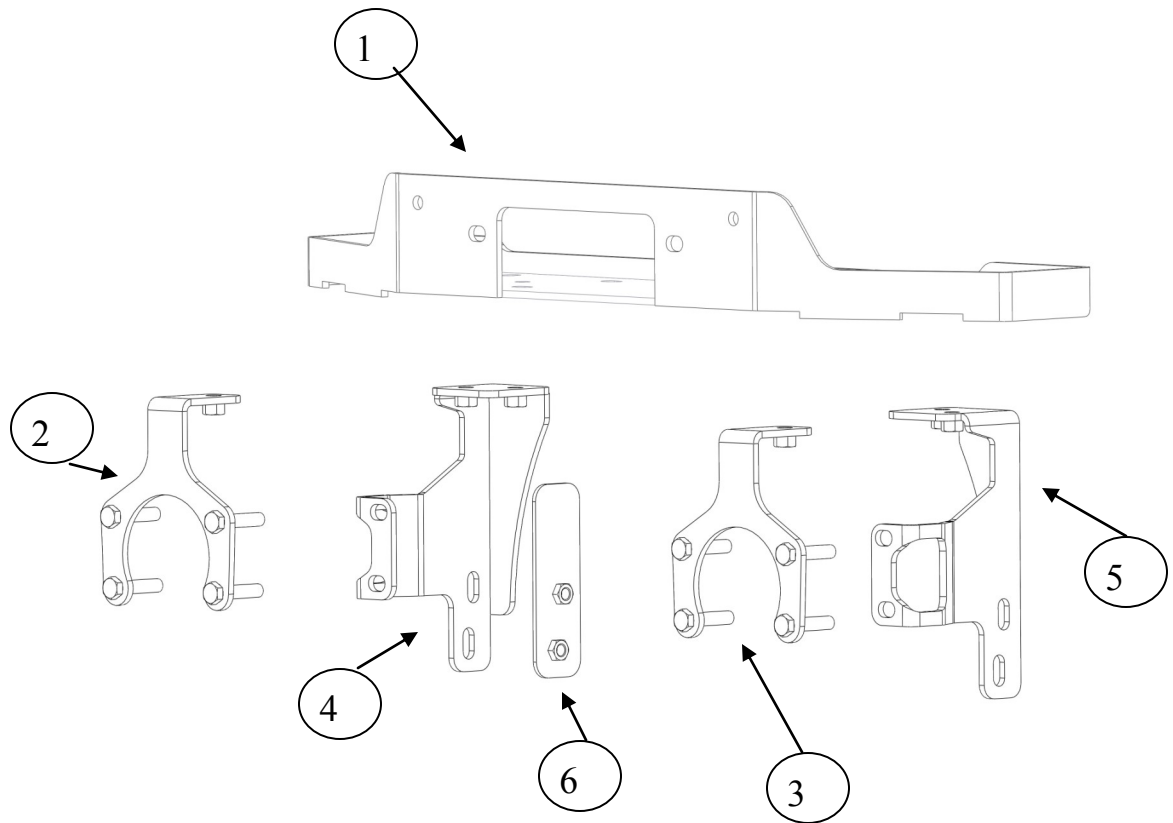

Westin Automotive Products, Inc.  
5200 N. Irwindale Ave. Suite 220  
Irwindale, Ca. 91706

Thank You for choosing Westin products  
For Additional installation assistance please call  
Customer service (800) 793-7846  
[www.westinautomotive.com](http://www.westinautomotive.com)



FIG 3

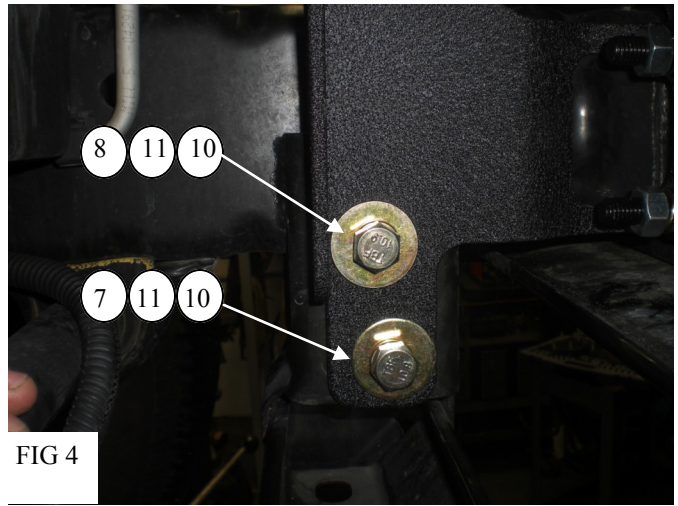

FIG 4

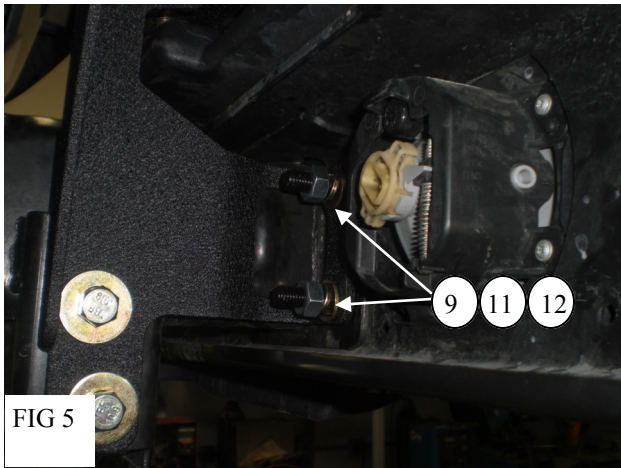
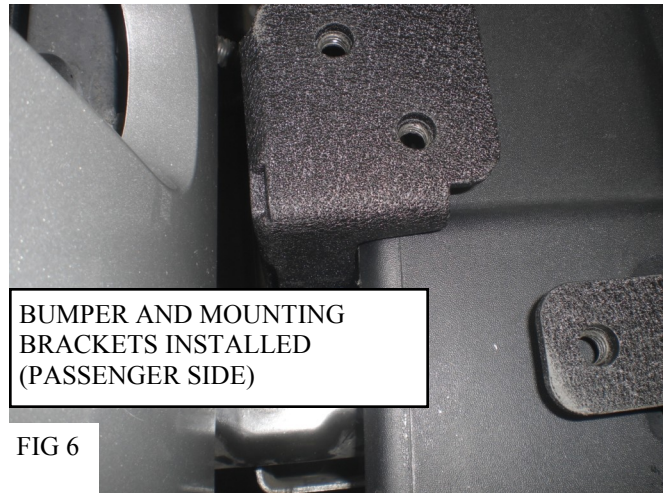

FIG 5



BUMPER AND MOUNTING BRACKETS INSTALLED (PASSENGER SIDE)

FIG 6

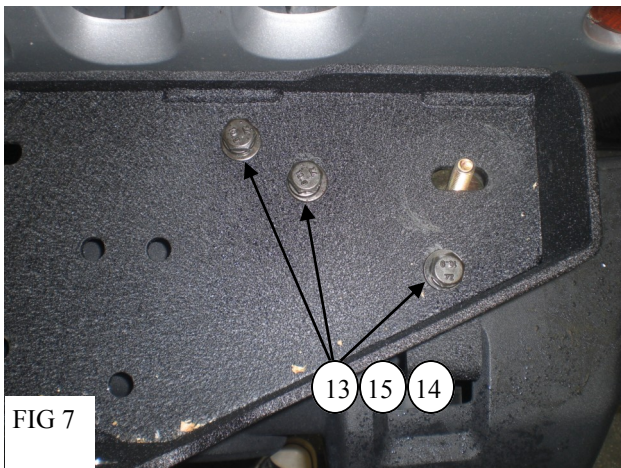

FIG 7



INSTALLATION COMPLETE (SHOWN WITH OPTIONAL WINCH TRAY BULL BAR)