

Installation Instructions for 93700-93749

In-Channel Side Window Visors

Important Safety Information

- **CAUTION** - Before driving, insure that the vent visor is properly secured to vehicle.
- Do not use automatic "brush-style" car washes.
- Do not use cleaning solvents of any kind.
- Periodically check all components to make sure they are secure

Contents – 2 Piece Set

Front Driver Side Visor

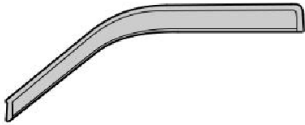

Front Passenger Side Visor

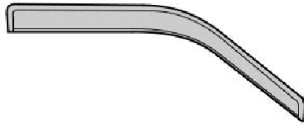

Alcohol Pad x2



Scuff Pad

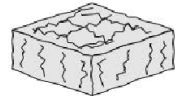

Contents – 4 Piece Set

Front Driver Side Visor

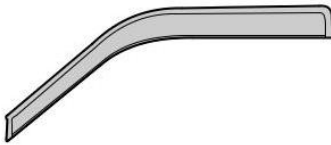

Front Passenger Side Visor

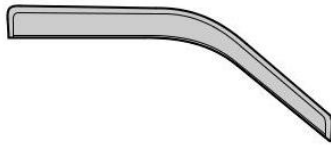

Rear Driver Side Visor



Rear Passenger Side Visor



Alcohol Pad x4

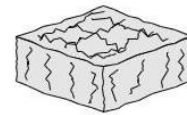

Scuff Pad

Preparation Before Painting/ Installation

- A trial fit is recommended to ensure proper positioning and fit
- Check fit of parts before painting as we will not accept the return of modified or painted parts
- Wash your vehicle to remove any debris and/or dirt from installation area.
- Dry the installation area with a clean towel

NOTE: Actual application may vary slightly from illustrations.



Roll down window. Buff the inside felt surface with scuff pad. Then clean with alcohol pad.



Clean

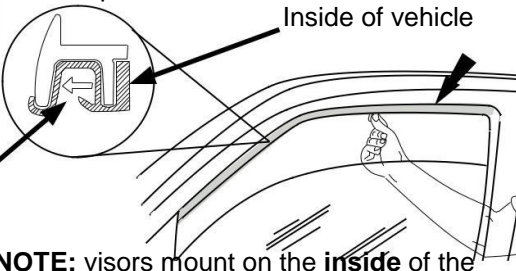

Inside of vehicle

1

NOTE: visors mount on the **inside** of the window channel.

Remove the tape from the front and rear flanges. Peel back 2" (5cm) of tape liner from each end of top flange.

Free end

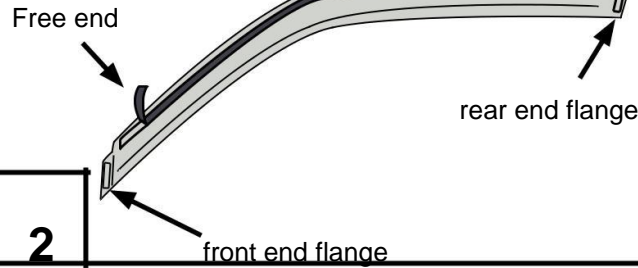

2

Slide the front end flange of the visor into position **outside** the window channel between the rubber trim and mirror cap. Then rotate visor up and slide top and rear flanges **inside** the window channel.

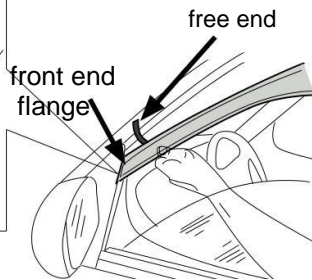
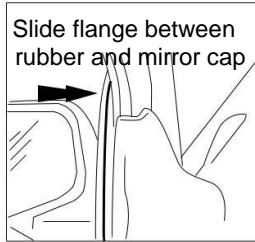

3

NOTE: Proper placement is important to prevent window from breaking flange during operation.

Press the exposed area of tape against the surface and verify position.

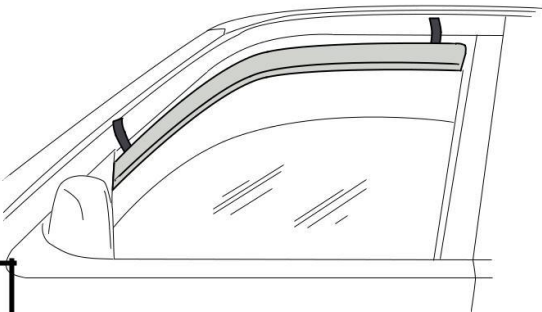

4

With the visor in its final position, remove the remainder of the tape liner by pulling on free ends.

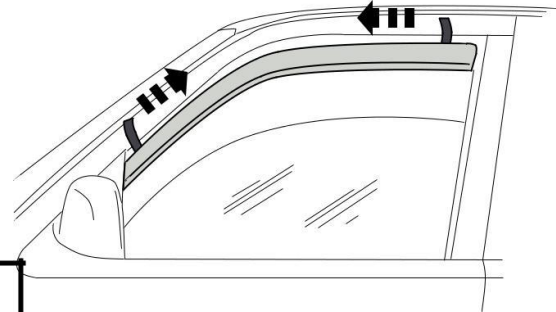

5

Apply pressure along the inside of window channel and flange edges to secure in place.

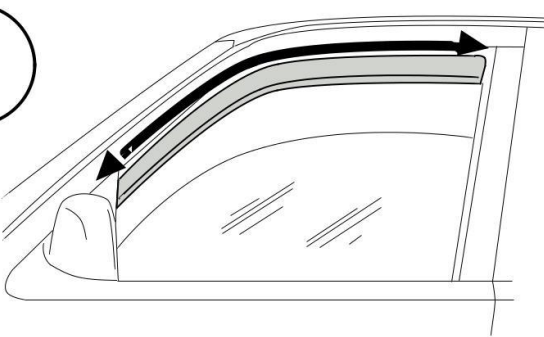

6

Roll up window and leave window up for 24 hours to ensure proper adhesion.

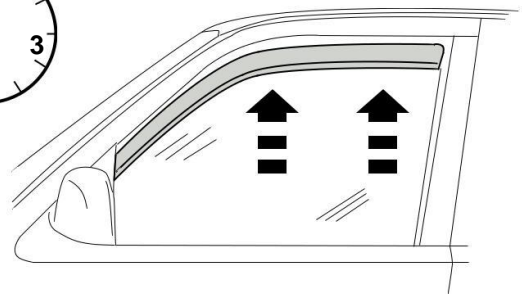
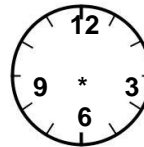

7



1-800-345-4545 jegs.com

4 Piece Set **NOTE:** Actual application may vary slightly from illustrations.

The driver side rear visor attaches to the felt surface following the same procedure.

Rear visor
in final position

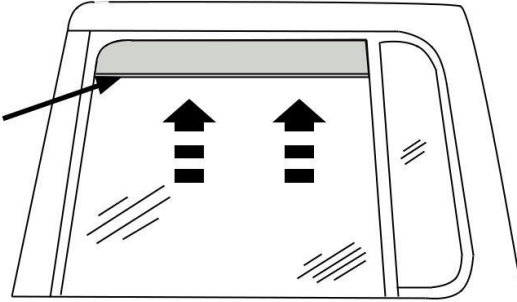

Repeat **Steps 1-8** for passenger side

8

Care and Cleaning

- Wash only with mild soap & dry with a clean cloth.

Congratulations!

██████████ We take the utmost pride in our products and want you to enjoy years of satisfaction from your investment. We have made every effort to ensure that your product is top quality in terms of fit, durability, finish and ease of installation.