



CD-7/CD-7 Carbon

Part Number	Description
30-5500	Aluminum Enclosure, Non-Logging
30-5501	Aluminum Enclosure, Logging
30-5502	Aluminum Enclosure, Non-Logging with VDM
30-5503	Aluminum Enclosure, Logging with VDM
30-5700	Carbon Fiber Enclosure, Non-Logging
30-5701	Carbon Fiber Enclosure, Logging
30-5702	Carbon Fiber Enclosure, Non-Logging with GPS
30-5703	Carbon Fiber Enclosure, Logging with GPS
30-5700F	Flat Panel, Carbon Fiber Enclosure, Non-Logging
30-5701F	Flat Panel, Carbon Fiber Enclosure, Logging
30-5702F	Flat Panel, Carbon Fiber Enclosure, Non-Logging with GPS
30-5703F	Flat Panel, Carbon Fiber Enclosure, Logging with GPS

CD-5 Carbon

Part Number	Description
30-5600	Carbon Fiber Enclosure, Non-Logging
30-5601	Carbon Fiber Enclosure, Logging
30-5602	Carbon Fiber Enclosure, Non-Logging with GPS
30-5603	Carbon Fiber Enclosure, Logging with GPS
30-5600F	Flat Panel, Carbon Fiber Enclosure, Non-Logging
30-5601F	Flat Panel, Carbon Fiber Enclosure, Logging
30-5602F	Flat Panel, Carbon Fiber Enclosure, Non-Logging with GPS
30-5603F	Flat Panel, Carbon Fiber Enclosure, Logging with GPS

Introduction

Dash Design 2.2 is a powerful tool used to create and edit AEM CD-X dash setups. The graphics design possibilities are extensive and this help documentation is not intended to cover all possible options. It will provide an overview of tools and features. An interactive help feature is included in the application. Hovering your mouse over certain target areas will trigger a tool tip that contains helpful information. There are two versions of this document, a System User Guide and a Quick Start Guide. The Quick Start Guide is a subset of the information found in the System User Guide. Both documents are installed with the software and can be found at the following location: \\Documents\AEM\DashDesign\Instructions. Additionally, the Windows online help feature located in the Help menu contains the exact same content.

Quick Start

AEM DashDesign 2 is distributed as a single install executable. To install, visit aemelectronics.com and click on Software Downloads and navigate to CD Dash/DashDesign. Download the software and then run the AEM DashDesign Setup.exe and follow the on-screen instructions including restarting computer if prompted to do so. If using the logging version of dash, also download and install AEMdata for downloading and analyzing data logs.

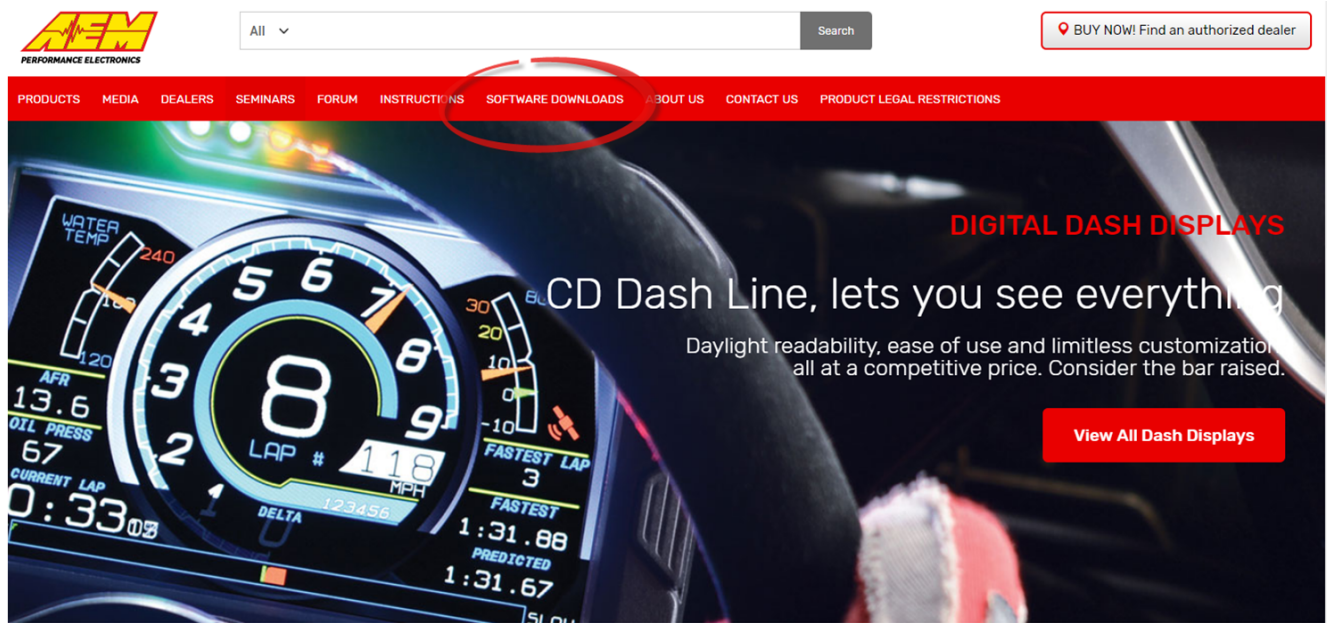

Click on table to jump to a specific software section

Infinity EMS	Series 2 EMS	EMS-4	Series 1 EMS
Fuel/Ignition Controllers	AQ-1 Data Logger	AEMData Logging and Analysis	Wideband Failsafe
Water/Methanol Failsafe	Serial Gauge	X-WiFi	CD-5 / CD-7 Carbon Dash Design

Follow the on screen prompts to install the application. Double click the shortcut to launch AEM Dash Design.



Infinity 71XX

If using an AEM supplied Infinity harness, simply plug the 4 pin Deutsch DTM connector from the dash harness into the corresponding connector on the Infinity harness labeled AEMNet. If using a custom designed harness, see the System User Guide [Electrical & Wiring](#) ⁽⁶⁰⁾ section for details. Note that a switched, 12V power source at the AEMNet connector is required for proper function of the Dash.

1. Be sure you have the latest software installed.
2. Connect the Dash to your PC using the supplied USB connector.
3. Turn the key on. Ensure the dash is powered up.
4. In the DashDesign software, go to Tools | Upload Firmware. The firmware files are located at \Documents\AEM\DashDesign\Firmware with the format CD-15x09.bin where x09 is an example version. See [Updating the Firmware Version](#) ⁽⁶⁸⁾ in the System User Guide for more detail.
5. In the DashDesign software, go to File | Open... and navigate to the library of pre-configured setup files for the Infinity. They are installed at the following location.
 \Documents\AEM\DashDesign\Setups\App Specific\AEM Infinity. Choose your file and click Open. See [Uploading a Setup File](#) ⁽⁶⁶⁾ in the System User Guide for more detail.

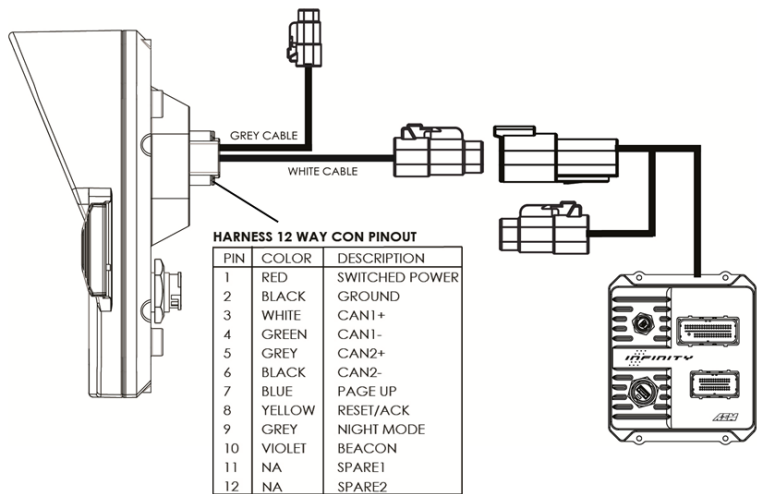

Series 2 or EMS-4

See Series II user documentation for location of the CAN1L and CAN1H circuits. Following is a pinout of the 4 pin Deutsch DTM connector on the Dash harness.

Pin	Function
1	AEMNet CAN+
2	AEMNet CAN-
3	+12V Power
4	Ground

Connect the CAN1H circuit from your Series II ECU to Pin 1 AEMNet CAN+. Connect the CAN1L circuit from your Series II ECU to Pin 2 AEMNet CAN-. Use optional AEM PN 35-2626 as mating connector.

1. Be sure you have the latest software installed.
2. Connect the Dash to your PC using the supplied USB connector.
3. Turn the key on. Ensure the dash is powered up.
4. In the DashDesign software, go to Tools | Upload Firmware. The firmware files are located at \Documents\AEM\DashDesign\Firmware with the format CD-15x09.bin where x09 is an example version. See [Updating the Firmware Version](#) in the System User Guide for more detail.
5. In the DashDesign software, go to File | Open... and navigate to the library of pre-configured setup files for the AEM Series2 & EMS-4. They are installed at the following location.
 \Documents\AEM\DashDesign\Setups\App Specific\AEM Series2 & EMS-4. Choose your file and click Open. See [Uploading a Setup File](#) in the System User Guide for more detail.

The AEMNet CAN output must be enabled in your Series II ECU before the dash can receive messages.

1. In AEMTuner, select Wizards | Setup Wizard and choose Telemetry: AEMNet from the Wizard Types column.
2. Left click on the Configuration Name AEMNet Datastream and click the Apply button to enable.

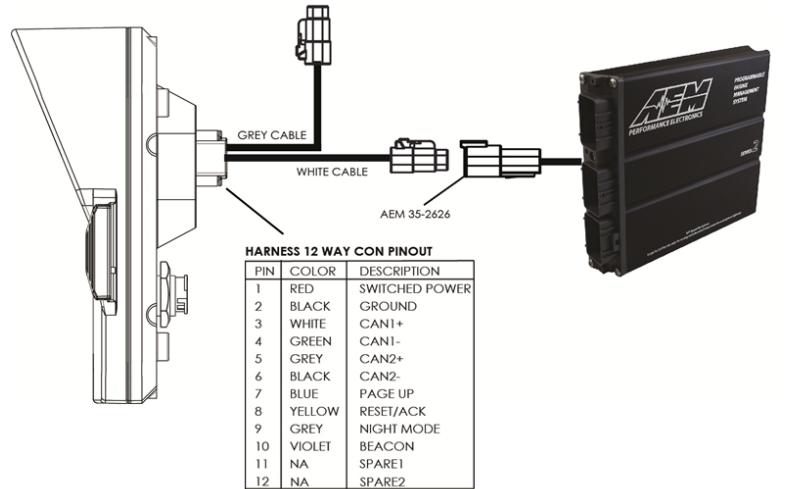

Series 1 ECU

The Series 1 ECU uses RS232 Serial Communications to send data to the dash. This requires the user to use the AEM 30-2228, Serial2CAN Adapter for the Series 1 ECU.

The Serial Telemetry must be enabled on the Series 1 ECU. This is done using the AEMPro Software.

Note: The serial datastream will only work with version 1.19 or newer firmware. When connected to the EMS, the firmware version is shown in the blue strip at the top of the screen. If your ECU is not running version 1.19 or later, you can download the required files from the aemelectronics.com website.

1. Open AEM Pro and connect to the EMS. Wait for the EMS to finish downloading.
2. Left click on "VIEW" and select the telemetry wizard from the wizards drop down menu.
3. In the telemetry wizard, left click on "AEM Serial Datastream Gauge:" and click OK. Close AEM Pro.
4. Connect the adapter to the EMS, and cycle power to the EMS. The EMS is now configured to output data to the gauge.

Since the Serial2CAN adapter shares the comms port with the PC communications cable, the ECU will always start in PC Comms mode when the power is cycled. If the ECU does not sense communications with a PC immediately it will then revert to data telemetry output. To initialize PC comms after the ECU has switched to telemetry mode you will need to power cycle the ECU.

The Serial2CAN adapter makes the Serial output from any AEM Series 1 ECU look like the CAN output of an AEM Series 2 ECU. So the fastest way to get something working on the dash is to use the AEM created setups for the Series 2 ECU. With the install of DashDesign2 on your computer there are many different base setups you can choose from.

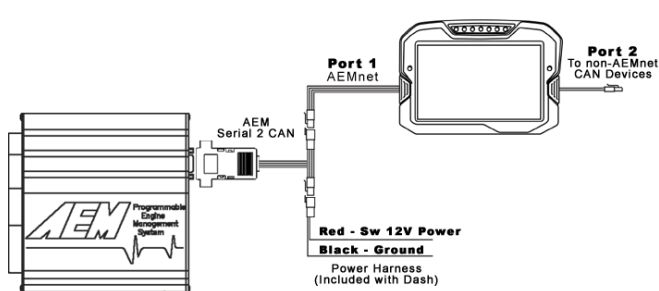

22 Channel CAN Sensor Module

1. Reference simplified connection diagram at right.
2. Be sure you have the latest software installed.
3. Connect the Dash to your PC using the supplied USB connector.
4. Turn the key on. Ensure the dash is powered up.
5. In the DashDesign software, go to Tools | Upload Firmware. The firmware files are located at \Documents\AEM\DashDesign\Firmware with the format CD-15x09.bin where x09 is an example version. See [Updating the Firmware Version](#) [68] in the System User Guide for more detail.
6. In the DashDesign software, go to File | Open... and navigate to the library of pre-configured setup files for the 22 Channel CAN Sensor Module. They are installed at the following location:
 \Documents\AEM\DashDesign\Setups\App Specific\AEM 30-2212 22 Ch CAN Sensor Module. Choose your file and click Open. See [Uploading a Setup File](#) [68] for more detail.
7. Alternatively, you may append a .dbc file for the 22 Channel CAN Sensor Module onto your existing setup. See the [Managing DBC File Imports](#) [10] section for more detail. .dbc files for the 22 Channel CAN Sensor Module are located in the
 \Documents\AEM\DashDesign\CAN folder. They will have *AEM 30-2212* in the filename.

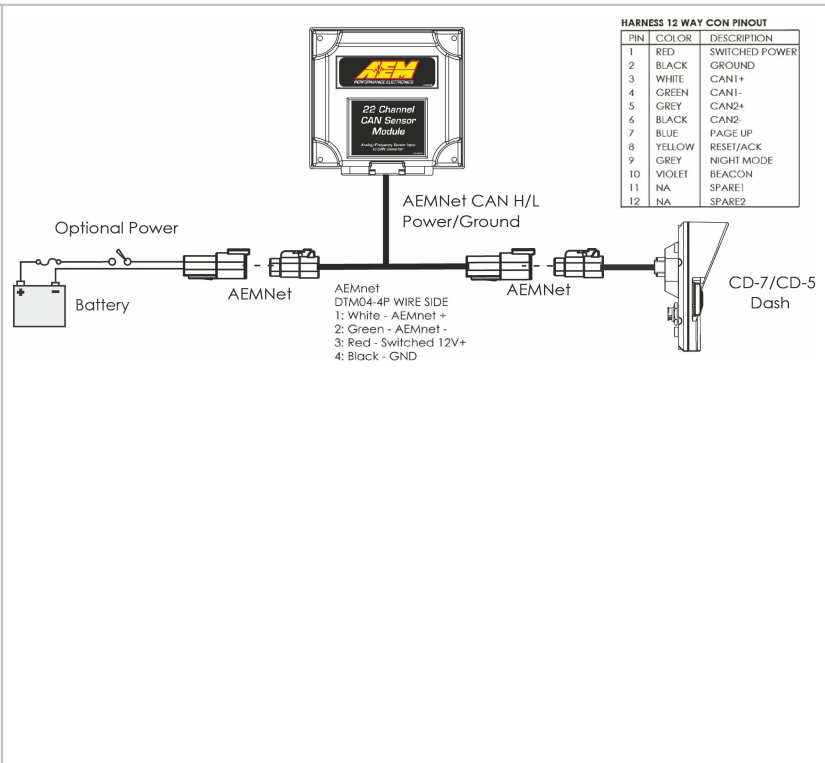

6 Channel CAN Sensor Module

1. Reference simplified connection diagram at right.
2. Be sure you have the latest software installed.
3. Connect the Dash to your PC using the supplied USB connector.
4. Turn the key on. Ensure the dash is powered up.
5. In the DashDesign software, go to Tools | Upload Firmware. The firmware files are located at \Documents\AEM\DashDesign\Firmware with the format CD-15x09.bin where x09 is an example version. See [Updating the Firmware Version](#) [68] in the System User Guide for more detail.
6. In the DashDesign software, go to File | Open... and navigate to the library of pre-configured setup files for the 6 Channel CAN Sensor Module. They are installed at the following location:
 \Documents\AEM\DashDesign\Setups\App Specific\AEM 30-2226 6 Ch CAN Sensor Module. Choose your file and click Open. See [Uploading a Setup File](#) [68] for more detail.
7. Alternatively, you may append a .dbc file for the 6 Channel CAN Sensor Module onto your existing setup. See the [Managing DBC File Imports](#) [10] section for more detail. .dbc files for the 6 Channel CAN Sensor Module are located in the
 \Documents\AEM\DashDesign\CAN folder. They will have *AEM 30-2226* in the filename.

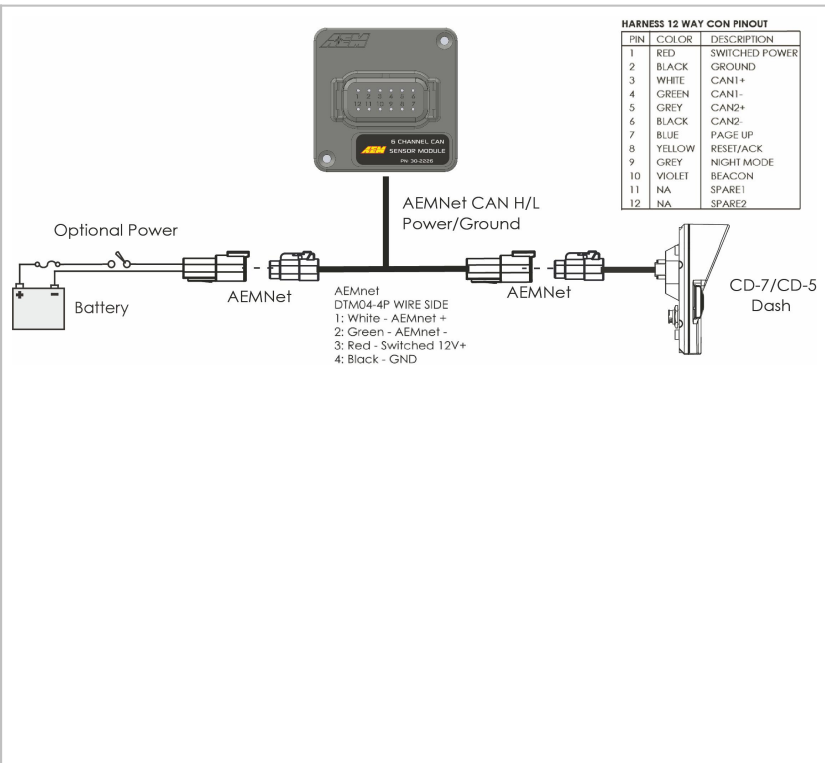

8 Channel K-Type EGT CAN Module

1. Reference simplified connection diagram at right.
2. Be sure you have the latest software installed.
3. Connect the Dash to your PC using the supplied USB connector.
4. Turn the key on. Ensure the dash is powered up.
5. In the DashDesign software, go to Tools | Upload Firmware. The firmware files are located at
 \Documents\AEM\DashDesign\Firmware with the format CD-15x09.bin where x09 is an example version. See [Updating the Firmware Version](#) ⁶⁸ in the System User Guide for more detail.
6. In the DashDesign software, go to File | Open... and navigate to the library of pre-configured setup files for the 6 Channel CAN Sensor Module. They are installed at the following location:
 \Documents\AEM\DashDesign\Setups\App Specific\AEM 30-2224 8 Ch EGT. Choose your file and click Open. See [Uploading a Setup File](#) ⁶⁸ in the System User Guide for more detail.
7. Alternatively, you may append a .dbc file for the 8 Channel EGT onto your existing setup. See the [Managing DBC File Imports](#) ¹⁶ in the System User Guide for more detail. .dbc files for the 8 Channel EGT are located in the \Documents\AEM\DashDesign\CAN folder. They will have *AEM 30-2224* in the filename.

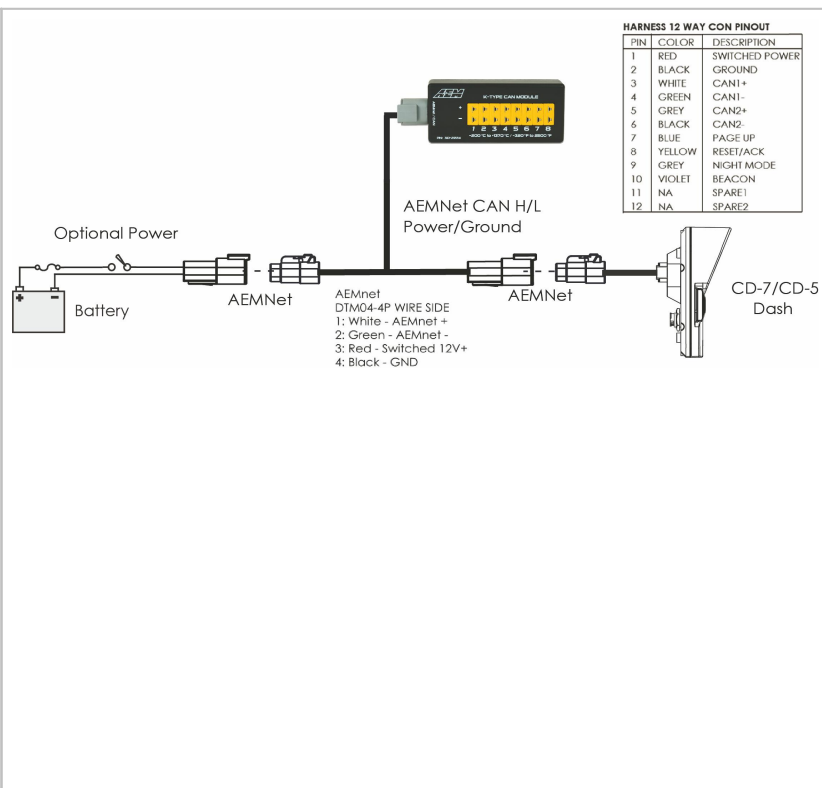

Vehicle Dynamics Module

1. Reference simplified connection diagram at right.
2. Be sure you have the latest software installed.
3. Connect the Dash to your PC using the supplied USB connector.
4. Turn the key on. Ensure the dash is powered up.
5. In the DashDesign software, go to Tools | Upload Firmware. The firmware files are located at
 \Documents\AEM\DashDesign\Firmware with the format CD-15x09.bin where x09 is an example version. See [Updating the Firmware Version](#) ⁶⁸ in the System User Guide for more detail.
6. Append a .dbc file for the Vehicle Dynamics Module onto your existing setup. See the [Managing DBC File Imports](#) ¹⁶ in the System User Guide for more detail. .dbc files for the Vehicle Dynamics Module are located in the \Documents\AEM\DashDesign\CAN folder. They will have *AEM 30-2203* in the filename.

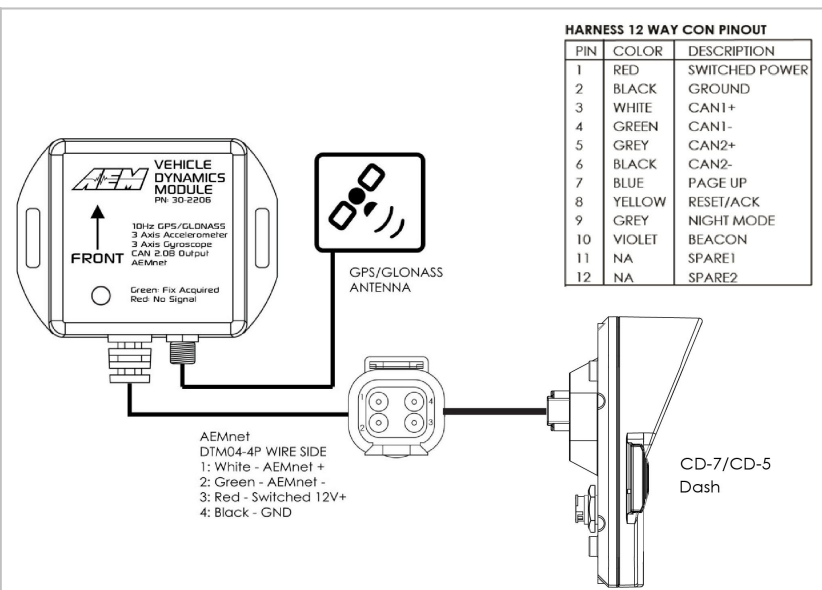

GPS Module

1. Reference simplified connection diagram at right.
2. Be sure you have the latest software installed.
3. Connect the Dash to your PC using the supplied USB connector.
4. Turn the key on. Ensure the dash is powered up.
5. In the DashDesign software, go to Tools | Upload Firmware. The firmware files are located at `\Documents\AEM\DashDesign\Firmware` with the format `CD-15x09.bin` where `x09` is an example version. See [Updating the Firmware Version](#) ¹⁶ in the System User Guide for more detail.
6. Append a `.dbc` file for the GPS Module onto your existing setup. See the [Managing DBC File Imports](#) ¹⁶ in the System User Guide for more detail. `.dbc` files for the GPS Module are located in the `\Documents\AEM\DashDesign\CAN` folder. They will have `AEM 30-2203` in the filename.

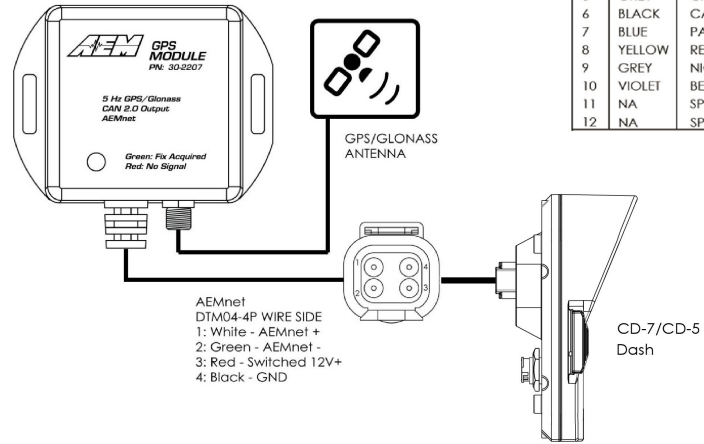

OBDII

1. Be sure you have the latest software installed.
2. Connect the Dash to your PC using the supplied USB connector.
3. Turn the key on. Ensure the dash is powered up.
4. In the DashDesign software, go to Tools | Upload Firmware. The firmware files are located at \Documents\AEM\DashDesign\Firmware with the format CD-15x09.bin where x09 is an example version. See [Updating the Firmware Version](#) ⁶⁸ in the System User Guide for more detail.
5. In the DashDesign software, go to File | Open... and navigate to the library of pre-configured setup files for OBDII. They are installed at the following location.
 \Documents\AEM\DashDesign\Setups\App Specific\OBDII. Choose your file and click Open. See [Uploading a Setup File](#) ⁶⁶ in the System User Guide for more detail.

To configure your dash for OBDII data display, the dash must scan your vehicle's OBDII port to identify all ECUs and available PIDs. PID stands for Parameter ID. These are codes used to request specific data from a vehicle.

Connect the OBDII interface cable to your vehicle's OBDII connector. To begin the scan process, launch AEM DashDesign and go to Tools | Scan Vehicle OBDII...

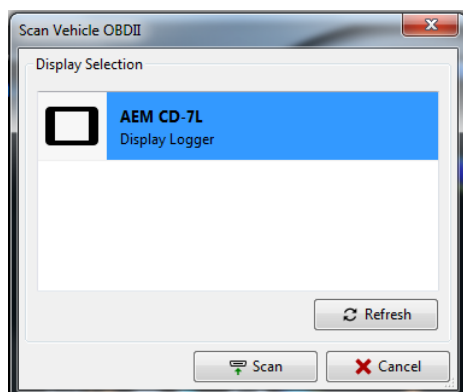

Click *Scan* and follow the on screen prompts. See [OBDII PID Scan](#) ⁶³ in the System User Guide for more detail.

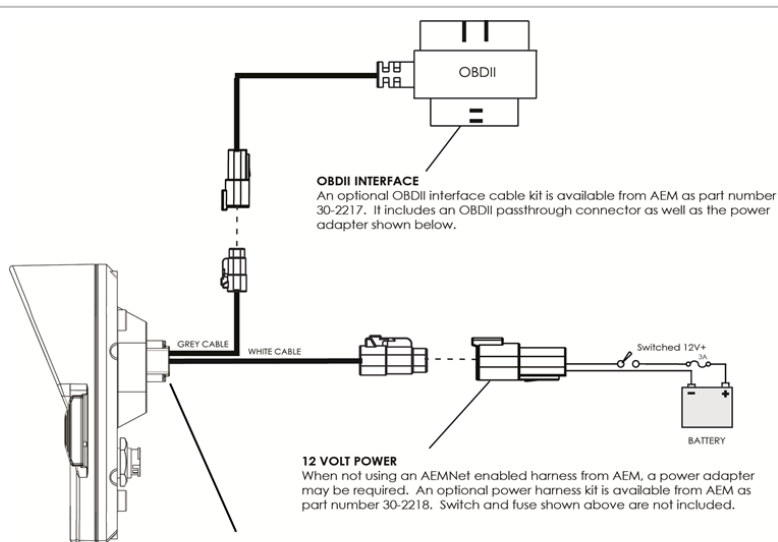

HARNESS 12 WAY CON PINOUT

PIN	COLOR	DESCRIPTION
1	RED	SWITCHED POWER
2	BLACK	GROUND
3	WHITE	CAN1+
4	GREEN	CAN1-
5	GREY	CAN2+
6	BLACK	CAN2-
7	BLUE	PAGE UP
8	YELLOW	RESET/ACK
9	GREY	NIGHT MODE
10	VIOLET	BEACON
11	NA	SPARE1
12	NA	SPARE2

A 3 amp fuse is required for switched power!

3rd Party Applications

Use CAN 2 (Port 2) for 3rd party devices. AEMNet (Port 1) is typically used for AEM devices to avoid confusion.

CAN 2 connector pinout:

PIN	COLOR	DESCRIPTION
1	GREY	CAN2+
2	BLACK	CAN2-

Workflow Tips

RECOMMENDED STEPS

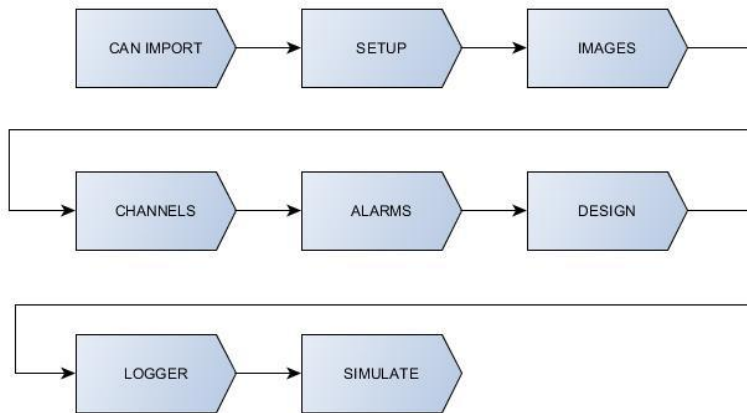

The basic workflow for creating a new setup or editing an existing setup:

1. CAN messages must exist before they can be displayed on screens. See the [CAN Tab](#) ^[13] section for more information.
2. Basic setup parameters are defined using the [Setup Tab](#) ^[17]. These include things like shift lights and screen brightness.
3. The [Images Tab](#) ^[20] is used to import all graphic assets for use in your setup.
4. Use the [Channels Tab](#) ^[22] to define custom channel names for CAN messages or to create your own custom channels from scratch.
5. Alarm channels must be defined before they can be used as inputs to display items. See the [Alarm Tab](#) ^[20] section for more detail.
6. Once all graphics, alarms and channels are defined, edit existing screens or design your own using the [Design Tab](#) ^[32].
7. If your dash hardware is equipped with internal logging, configure your logging preferences using the [Logger Tab](#) ^[40].
8. Finally, use the [Simulate Tab](#) ^[41] to test your setup. Simulate channel data and watch your screens come to life right on your PC screen.
9. Update the firmware to the latest version. See [Updating the Firmware Version](#) ^[68] in the System User Guide for more detail. If the latest firmware is not installed, attempts to upload the setup file may cause errors.
10. Save your setup and upload it to your dash. See the [Uploading a Setup File](#) ^[66] section.

Menus

File

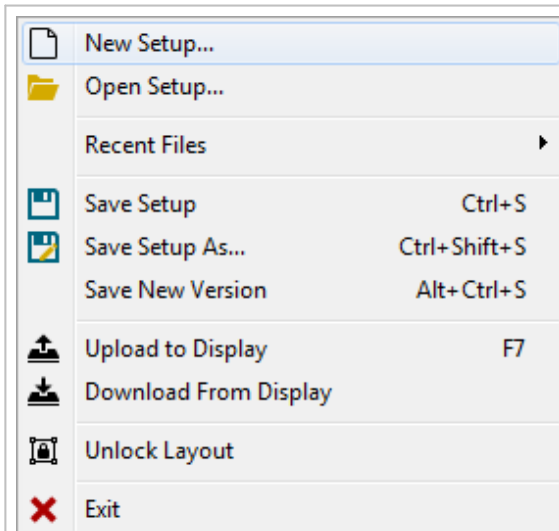

New Setup... Creates a new Setup file from scratch

Open Setup... Opens an existing Setup file

Recent Files is a list of recently opened Setup files

Save Setup saves the existing Setup file to disk

Save Setup As... saves the existing Setup file to disk with a new name

Save New Version saves the existing Setup file to disk with an automatically incremented suffix number.















Upload to Display loads the existing setup onto a CD-X dash. The PC must be connected to the dash with the included USB cable and the dash must be powered on. See [Uploading a Setup File](#) ^[66] for more details.

Download From Display saves a Setup file to disk that is currently loaded onto a CD-X dash. See [Downloading a Setup File](#) ^[67] for more details. The PC must be connected to the dash with the included USB cable and the dash must be powered on.



Unlock Layout unlocks the layout so gauge items can be edited.

Exit exits the program.

Edit

	Undo	Ctrl+Z	<p><i>Undo</i> removes the last edit <i>Redo</i> reapplies an edit that was previously undone <i>History</i> displays a running log of recorded edits. See the Edit History ^[38] section for more detail. <i>Cut</i> cuts a selection <i>Copy</i> copies a selection <i>Paste</i> pastes a selection <i>Delete</i> deletes a selection <i>Select All</i> selects all items on the current screen <i>Select None</i> deselects all previously selected items <i>Group, Ungroup, Raise, Lower, Raise to Top, Lower to Bottom</i> - See the Screen Editing ^[32] section for more details.</p>
	Redo	Ctrl+Y	
	History	Ctrl+H	
	Cut	Ctrl+X	
	Copy	Ctrl+C	
	Paste	Ctrl+V	
	Delete	Delete	
	Select All	Ctrl+A	
	Select None	Esc	
	Group	Ctrl+G	
	Ungroup	Ctrl+Shift+G	
	Raise		
	Lower		
	Raise to Top		
	Lower to Bottom		



Screen

	Clear Screen		<p><i>Clear Screen</i> removes all items from the current screen. <i>Duplicate Screen</i> launches a dialog that allows you to copy all items from any screen in the setup to the current screen. <i>Import Screen</i> replaces all items in the current screen with items from any screen that exists within any setup on your PC. <i>Select Screen</i> launches a selection dialog window that allows screen selection.</p> <p>See the Pages ^[32] section for more details.</p>
	Duplicate Screen		
	Import Screen		
	Select Screen		



View

	Toggle Fullscreen Mode	F11	<p><i>Toggle Fullscreen Mode</i> displays the window full screen <i>Reset Workspace Layout</i> resets the layout of windows docked to the edges of the frame</p>
	Reset Workspace Layout		

Tools

	Program Clock...		<p><i>Program Clock</i> synchronizes the CD-X internal hardware clock with the clock on your PC. See the Program Clock ^[67] section for more details. <i>Upload Firmware...</i> reprograms the CD-X with a different firmware file. Firmware is the internal operating system. See the Updating the Firmware Version ^[68] section for more details. <i>Scan Vehicle OBDII...</i> initiates a utility that probes the vehicle for available OBDII CAN messages. See the OBDII PID Scan ^[63] section for more details.</p>
	Upload Firmware...		
	Scan Vehicle OBDII...		

Configure

-  Unit Preferences...
-  Keyboard Shortcuts...
-  Toggle Dark Theme

Unit Preferences... allows the user to set global unit preferences.

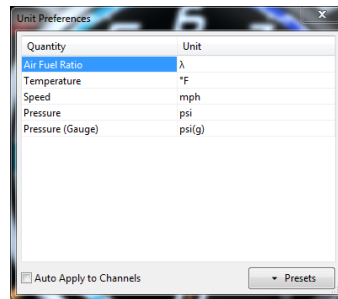

For each quantity, a list of unit preferences is available. Select from the drop down list.

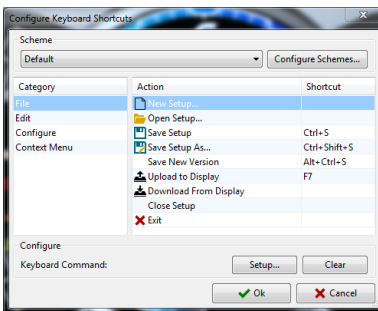
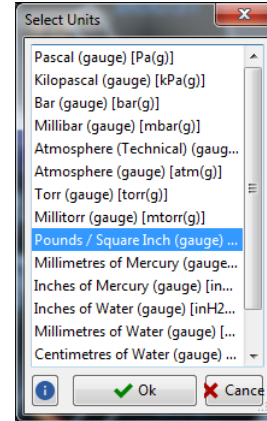

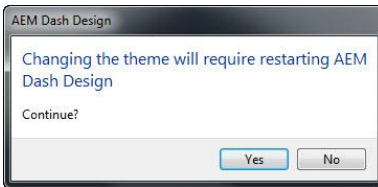

Keyboard Shortcuts... may be customized as desired. Actions available for customization are available through the *Keyboard Shortcuts...* menu.



Toggle Dark Theme... allows the user to toggle between a light a dark theme. A restart is required.

Help

-  Help... F1
-  About... Shift+F1
-  Check for Update

The *Help...* menu will launch a version of this document.

About Dash Design... will display application version info.

Check for Update will check for new versions of the software. If an update is available, follow the prompts to perform the update within the software.

Main Tabs Overview

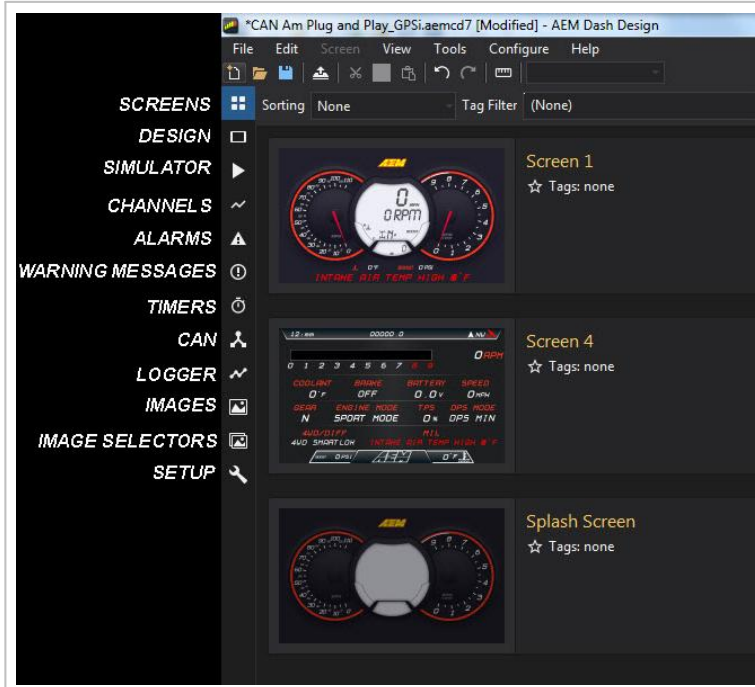

Twelve main tabs are used to create and edit a dash display setup. The tabs are accessible via vertically arranged icons on the left hand side of the window.

Screens - managing screens and creating and configuring graphical gauge elements

Design - Select, place and edit screen elements

Simulator - Dynamically simulate your configuration

Channels - editing value based channels

Alarms - define channel based logic that controls the dash alarm indicators

Warning Messages - Create and edit warning messages for display

Timers - Create and edit timers for display

CAN - define CAN receive and transmit channels

Logger - define internal logger channels and trigger criteria

Images - Library for all images used in the configuration

Image Selectors - Create and edit image selectors

Setup - define miscellaneous hardware features

CAN Tab

The AEM CD-X series dashes are designed to display and transmit CAN message data. The CAN setup must be defined in order to display data on screens or transmit data to other devices. DashDesign2 includes a feature for automatically importing pre-configured CAN setups. These setups have either a .dbc or .aemcan file extension. Available files will be installed in the \Documents\AEM\DashDesign2\CAN directory.

CAN Receive

CAN Receive is used to display CAN data on the dash, using other CAN devices as a source.

Port
 Show Baudrate Termination Resistor

The Show menu selects which Port to display and edit. There are two CAN ports available on CD-X dashes.

The Baudrate menu sets the data transmit rate for the selected bus.
IMPORTANT: All devices on a given CAN port must be set to the same value or the bus will not function.

The Termination Resistor check box enables the internal 120 ohm termination resistor for the selected CAN port. Every physical CAN bus needs to have 2 termination resistors installed, one on each physical end of the bus.

Port Mode
 Normal Mode

Normal Mode means this port operates as a normal CAN bus port. OBDII Mode means this port is used exclusively to receive CAN Based OBDII Vehicle Parameters (J1979 Mode 1 PIDs). Click the Import OBDII Scan...button to configure OBDII CAN channels.

MoTeC M800 Support

Off
 Set 1
 Set 3
 ID:

Off disables the unique Motec hundred series CAN support.

Set 1 configures this port to receive a Motec M800 Dataset 1 CAN stream. Most Hundred Series ECU's (M400, M600, M800, M880), with the exception of the M84, can send Dataset 1. Confirm the Dataset that the ECU is transmitting.

Set 3 Configures this port to receive a Motec M800 Dataset 3 CAN stream. All Hundred Series ECU's (M84, M400, M600, M800, M880) can send Dataset 3 and this is the preferred Motec Dataset. Confirm the Dataset that the ECU is transmitting.

Use the ID text box to enter the base address for the selected Dataset. The default Motec address for Dataset 1 is 0x5F0 (1520 decimal). The default Motec address for Dataset 3 is 0x0E8 (232 decimal). **IMPORTANT**, Confirm the base address that the ECU is sending the data out on and enter that value here, don't assume the ECU is using the default values. If you want to enter the address as a decimal number, then un-check the "Show CAN IDs in Hexadecimal" check box lower down on the page.

Address Mask

Enabled
 Mask:

Subjects all incoming message addresses to a logical mask to strip out unwanted information. In most cases this is used to remove unique device information and leave only a core address. If enabled, the value entered as the mask is subjected to a logical AND with the received address and the resulting value is treated as the CAN message address for all decoding purposes. Address masking is not a common requirement but it is used on most of the Holley EFI controllers which require a mask of 0xFFFFF800.

Show CAN IDs in Hexadecimal

Toggles between displaying the CAN ID's as either decimal and hexadecimal values. It is important to understand that this does not change the underlying CAN ID value, only the way you choose to see and enter it. Most devices use hex but a few use decimal. If you have any documentation that contains addresses beginning with "0x" or containing any letters then it is definitely Hexadecimal

CAN Message Layout

Byte	7	6	5	4	3	2	1
Byte 0	7	6	5	4	3	2	1
Byte 1	15	14	13	12	11	10	9
Byte 2	23	22	21	20	19	18	17
Byte 3	31	30	29	28	27	26	25
Byte 4	39	38	37	36	35	34	33
Byte 5	47	46	45	44	43	42	41
Byte 6	55	54	53	52	51	50	49
Byte 7	63	62	61	60	59	58	57

Multiplexor:

The CAN message layout is a tabular representation of the message structure. Click a message in the list below to update.

The Multiplexor selection box allows you to choose the specific multiplex switch value to show for multiplexed messages.

Signal	ID
AFR1	0x01F0A003
✓ AFR1ControlTrim	0x01F0A006
✓ AFRTarget	0x01F0A004
✓ BoostControlTarget	0x01F0A00B
✓ CoolantFan1State	0x01F0A004
✓ CoolantTemp	0x01F0A000
✓ CoolantTempErrorState	0x01F0A008
✓ ECUBatteryVoltage	0x01F0A003
✓ EngineSpeed	0x01F0A000
✓ EngineVolumetricEfficiency	0x01F0A004
✓ FuelInj1Pulsewidth	0x01F0A006
✓ FuelInjDutyPrimary	0x01F0A006
✓ FuelPresErrorState	0x01F0A008

AEM provides pre-configured CAN definition files. Click the Import CAN/DBC... button. Available files will be installed in the \Documents\AEM\DashDesign2\CAN directory.

The Clear button will remove all messages from the list.

 will add a new undefined message.

 will delete the selected message.

CAN Request

Some CAN devices require the dash to request the data from the source. Use this page to configure the CAN setup.

CAN Transmit

The CAN Transmit page works similarly to the CAN Receive page. There is a button at the bottom of the page to automatically add the GPSi messages (only for displays that have internal GPS).

CAN Status Outputs

The CAN Status output can be used to display the state of the current CAN port by setting it as the input to a Dynamic Text Display. The following status messages will be displayed:

- CAN 1 OK: The CAN bus is working correctly.
- CAN 1 DISABLED: The CAN bus has not been setup or is not present.
- CAN 1 BUS OFF: A serious error has occurred on the CAN bus - this may be due to the wrong baud rate being set or the CAN wires shorted together.
- CAN 1 Disconnected: No messages have been received by the display in the last three seconds.
- CAN 1 Warning: Errors are present on the bus; this may be due to incorrect baud rate or noise.
- CAN 1 Tx not acknowledged: A message sent by the dash has not been acknowledged by any nodes on the network.
- CAN 1 TOO MANY MESSAGES: The total number of messages that the display is being asked to receive and transmit exceeds the capability of the CAN hardware. This can be overcome by using CAN message masks.
- CAN 1 Rx Timeout: Traffic is present on the bus but none of the channels that the dash has been set up to monitor on the current screen (and monitor screen) are present.

AEMNet Enabled Device Reference

If available from AEM, pre-configured setups are available within the \Documents\AEM\DashDesign\Setups base directory in the sub directory listed in the table below. CAN DBC files are located in the \Documents\AEM\DashDesign\CAN directory.

Product Part Number	Product Name	Pre-configured Setups	.dbc files
30-2212	22 Channel CAN Sensor Module	<i>\App Specific\AEM 30-2212 22 Ch CAN Sensor Module</i>	<i>AEM 30-2212 CAN Sensor Module20180212.dbc</i>
30-2226	6 Channel CAN Sensor Module	<i>\App Specific\AEM 30-2226 6 Ch CAN Sensor Module</i>	<i>AEM 30-2226 CSM6 20180713.dbc</i>
30-2224	8 Channel K-Type EGT Module	<i>\App Specific\AEM 30-2224 8 Ch EGT</i>	<i>AEM 30-2224 EGT8.dbc</i>
30-03X0	X-Series UEGO Gauge & Inline UEGO	Not available	<i>AEM X-Series Gauges Rev0.dbc AEM 30-03X0 X-Series UEGO 20161011.dbc</i>
30-6XXX	EMS Series II	<i>\App Specific\AEM Series2 & EMS-4</i>	<i>AEM 30-6XXX EMS-V2 20161128.dbc</i>
30-71XX	Infinity EMS	<i>\App Specific\AEM Infinity</i>	<i>AEM 30-71XX Infinity 20161021.dbc</i>
30-7108TA	Infinity EMS, TA2	<i>\App Specific\AEM Infinity</i>	<i>AEM 30-7108TA TransAm TA2 Spec Infinity 20161213.dbc</i>
30-2340	4 Channel UEGO	Not available	<i>AEM 30-2340 4Ch UEGO 20161213.dbc</i>
30-4900	Wideband Failsafe Gauge	Not available	<i>AEM 30-4900 Wideband Failsafe 20161014.dbc</i>
30-4911	Flex Fuel Failsafe Gauge	Not available	<i>AEM 30-4911 Flex Fuel Failsafe 20161013.dbc</i>
30-6905	EMS-4	Not available	<i>AEM 30-6905 EMS-4 20170823.dbc</i>
30-2203 30-2206	Vehicle Dynamics Module	Not available	<i>AEM 30-2203 VDM 20161018.dbc AEM 30-2206 VDM 20190312.dbc</i>
30-2207	GPS Module	Not available	<i>AEM 30-2207 GPS 20190312.dbc</i>

Product Part Number	Product Name	Pre-configured Setups	.dbc files
30-2230 30-2231	Serial to CAN, Motec M4	\\App Specific\Motec_M4	AEM 30-2230 2231 S2C_Motec_M4_Rev0.dbc
30-2228	Serial to CAN, AEM Series1 EMS	\\App Specific\AEM Series2 & EMS-4	AEM 30-2228 S2C_AEMS1ECU_Rev0.dbc
30-2229	Serial to CAN, Hondata KPro	\\App Specific\Hondata_KPro1-3	AEM 30-2229 S2C_Hondata_KPro_Rev0.dbc

Managing DBC File Imports

The screenshot shows the 'Import CAN' dialog box with a tree view. The root node is 'AEM 30-2226 CSM6 20180713.dbc'. Underneath, there is a folder 'AEM_CSM6' which is expanded. Inside 'AEM_CSM6', there are two message folders: 'MSG_0x0000B600 (0x0000B600)' and 'MSG_0x0000B601 (0x0000B601)'. The 'MSG_0x0000B600' folder is expanded, showing a list of messages: 'AnalogResistanceExt_1', 'AnalogResistanceExt_2', 'AnalogVoltsExt_3', and 'AnalogVoltsExt_4'. The 'MSG_0x0000B601' folder is also expanded, showing 'BatteryVoltsExt', 'FuelLevelExt', and 'TachoFrequencyExt'. Each message has a checkmark to its left, indicating it is selected. At the bottom of the dialog are 'Ok' and 'Cancel' buttons.

The button allows you to import all available messages or simply a subset. Expand the menu structure as shown to see details. Toggle the check box to the left of each message to include or exclude. Click OK and your selection will be appended to the CAN receive signal list.

Setup Tab

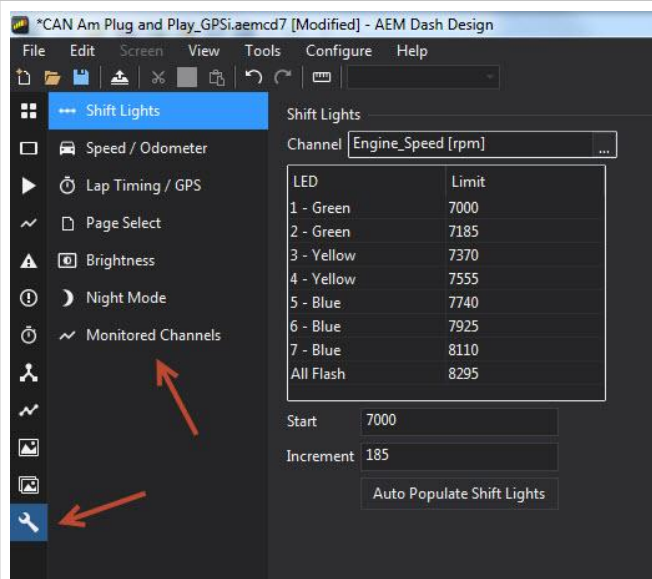

The setup sub tabs are accessed by clicking the  icon.



Shift Lights

Channel

LED	Limit
1 - Green	5000
2 - Green	5285
3 - Yellow	5570
4 - Yellow	5855
5 - Blue	6140
6 - Blue	6425
7 - Blue	6710
All Flash	6995

Start

Increment

Configure the seven shift light LEDs by first selecting a channel (typically EngineSpeed [rpm])

Select an RPM threshold for each LED or alternatively, select a starting RPM, an increment value and click Auto Populate Shift Lights. Exceeding the last shift light by this value will cause all lights to flash. If you simply want all LEDs to turn on and flash at the same value, enter that number as the start value and set the increment as 0, then click Auto Populate Shift Lights.

Brightness Setup

Screen

Normal Mode

Night Mode

Shift and Warning Lights

Normal Mode

Night Mode

0% equals off. Night mode is active when the night mode input (pin 9) is pulled high.

The Brightness setup dialog allows you to choose two different brightness settings for both the screen and LEDs. 100% should only be used in direct sunlight. 70% gives almost as much brightness without over driving the backlight. 5%-10% is appropriate for night mode. If the LEDs are directly in line with the drivers eyes you may find the best shift light brightness settings for night mode to be as low as 1 or 2%.

Lap Timing Mode

Beacon GPS

Beacon Type

Standard AIM

Optional lap timing features require a location reference for the start/finish line. Select Beacon for a beacon input. Select GPS to use a GPS reference. If using a beacon, select either Standard or AIM type.

With lap timing configured, the race vehicle can be driven on track to collect GPS data. At the exact moment when crossing the start/finish line, the lap beacon button should be pressed and held momentarily until both the amber and red LEDs flash on the dash. The lap beacon button is an external input that must be added using the violet wire input. See [Electrical & Wiring](#)⁶⁰. The flashing LEDs indicate that the start/finish line GPS coordinates have been successfully set. Each time the vehicle crosses the start/finish line, a new lap will be counted and lap timer will reset.

Average Speed Setup

Input for average lap speed and predictive lap:

Select the speed channel to use when calculating the average lap speed and the predictive lap time.

GPS Mode Setup

Longitude

Latitude

Course

Track Width [m]

Select channel inputs to use for GPS Latitude, Longitude and Course.





Track Width [m] is the maximum possible width at the start/finish line that the vehicle could pass through.

Odometer Setup

Speed input to the odometer.
This channel must be scaled in kilometers per second.

Speed [km/s]

This is an internal counter backed up to non-volatile memory that cannot be reset (it is set to zero when the unit is built). Select an input that is road speed in km per second. All AEM base setups include an odometer scaled in both miles and kilometers.

<p>Page Select Source</p> <p>Select a channel to be used for page selection. The value matches the page number.</p> <input type="text"/> 	<p>An optional method of choosing which page should be displayed on the dash. A page channel can be selected here and as long as it has values of 1-4 then the dash will display those pages. Normally, the pages are changed by pressing the left button or grounding the page increment input to the dash.</p>
<p>Night Mode Control</p> <p>Night mode trigger channel: 0 => day mode brightness. 1 => night mode brightness. If set, overrides the Night Mode pin.</p> <input type="text"/> 	<p>Night Mode is set whenever the Night Mode pin on the connector (Pin 9, Gray wire) is pulled to 12V. Night mode can also be triggered via a CAN message identified here.</p>
<p>Monitor Channels</p> <div style="border: 1px solid #ccc; padding: 5px; margin-bottom: 10px;"><p>Channel</p><div style="height: 200px;"></div></div> <div style="display: flex; justify-content: flex-end; gap: 10px;"></div>	<p>Normally a given channel is only monitored if used by a gauge on the currently displayed screen. In certain circumstances however, it is necessary to monitor some channels regardless of whether or not they are used by the currently displayed screen page. For example, if the maximum coolant temperature is required as a channel for some screens, switching screens deletes the data as the screen changes and recreates it if necessary. The maximum value is then reset and its information is lost. By adding this channel to the monitor page it is created when the color display is switched on. Changing screens has no effect on the channel and the data is not reset unless a reset signal is received.</p> <p>Furthermore, channels added to the monitor screen are automatically stored in non-volatile memory. Thus, the value of a min, max or average added to the monitor screen is preserved even when the screen is powered off.</p>

Alarm Tab

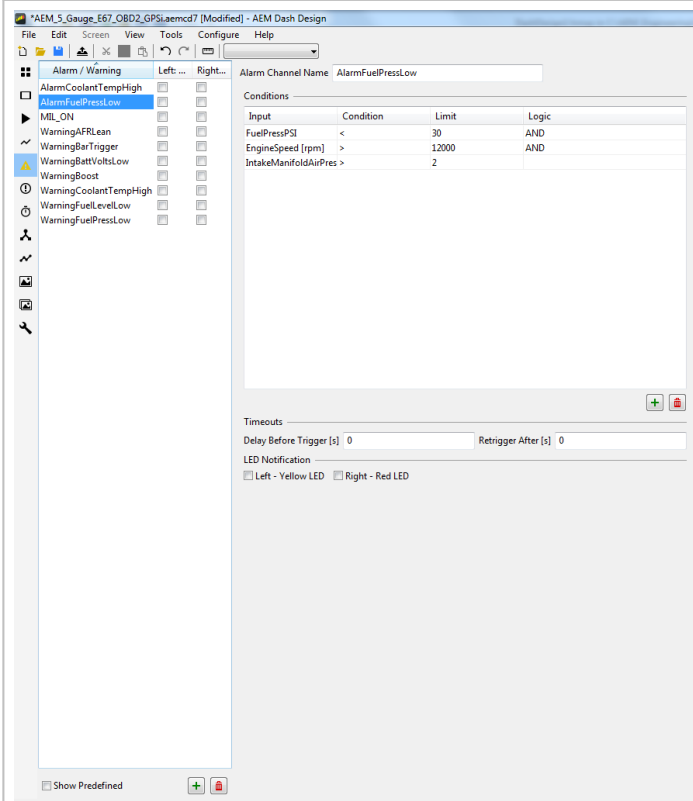

The *Alarm/Warning* table is a list of alarms and warnings. Click the button to add a new entry. Assign a unique name to the channel using the *Alarm Channel Name* dialog. For newly created alarm/warning channels, add conditions using the

Conditions table. Click the button to add new entries. Select an input from the list of available channels using the *Input* column of the table. Add additional conditions as needed.

When defining alarms, the possible conditions are:

- < Less Than
- > Greater Than
- = Equal to
- <> Not Equal to
- <= Less than or Equal to
- >= Greater than or Equal to

The logic is performed from top to bottom with the running result of the last performed test being carried forward as the input to the next test.

Timeouts/Delay Before Trigger [s] specifies a timeout in seconds that the conditions for the alarm must be met before the alarm will trigger.

Timeouts/Retrigger After [s] Specifies a timeout in seconds after which the alarm (if still triggered) will toggle to untriggered and back to triggered.

This is useful for when an alarm has been used to trigger a page change, usually showing a warning to the driver, for example, low oil pressure. The driver can select the standard page again to cancel the alarm. If the oil pressure is still low after the specified period, then the warning page will be shown again. If the retrigger value is set to zero, then the alarm will only retrigger if the input conditions change to false and back to true again.

Select the preference for Yellow/Red LED using the *LED Notification* check boxes.

Images

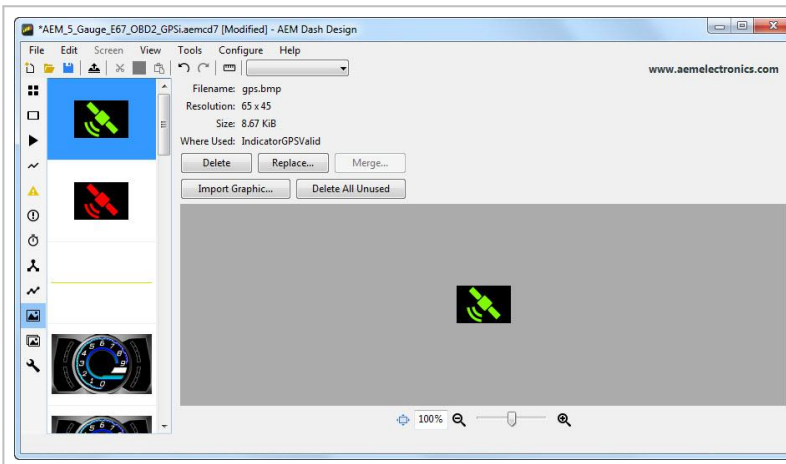

Import Graphic... adds a new image to the setup file. Once loaded, the graphic may be used on any screen or within any image selector.

Delete removes the selected image from the setup file.

Replace... replaces the selected image with a new image from the disk.

Delete All Unused removes all unassigned images from the setup file. Unused images increase the setup file size and adversely affect performance.

Selectors

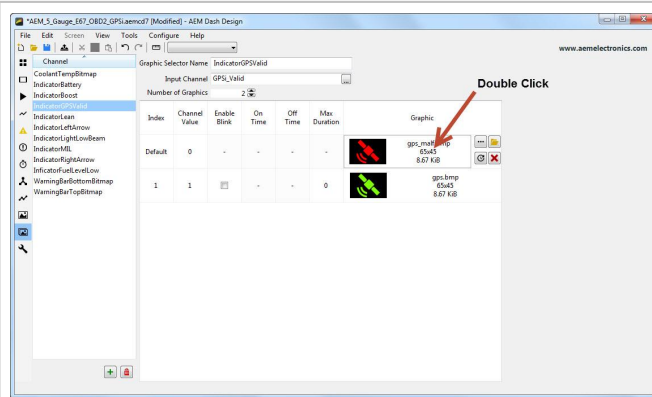

Graphic Selector Name is the unique name of the graphic selector channel. Images defined as part of a graphics selector will have a unique identifier when they appear in a selection window. See example below.

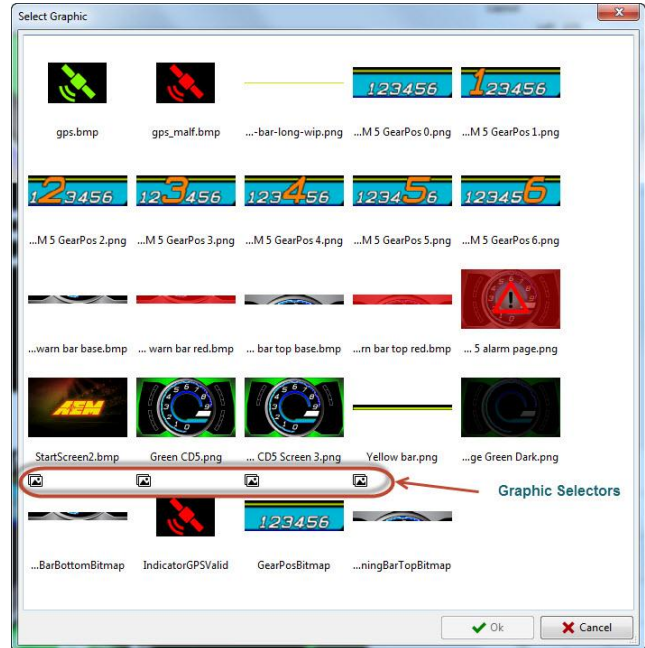

Input Channel is the channel used as the reference index, controlling which image to display.

Number of Graphics is the number of different image possibilities this selector will have. The table below will update based on this value.

Graphic Selector Name: GearPosBitmap
 Input Channel: GearPosCalculated
 Number of Graphics: 7

Index	Channel Value	Enable Blink	On Time	Off Time	Max Duration	Graphic
Default	0	-	-	-	-	AEM 5 GearPos 0.png 121x38 2.19 KiB
1	1	<input type="checkbox"/>	-	-	0	AEM 5 GearPos 1.png 121x38 2.60 KiB
2	2	<input type="checkbox"/>	-	-	0	AEM 5 GearPos 2.png 121x38 2.76 KiB
3	3	<input type="checkbox"/>	-	-	0	AEM 5 GearPos 3.png 121x38 2.70 KiB
4	4	<input type="checkbox"/>	-	-	0	AEM 5 GearPos 4.png 121x38 2.73 KiB
5	5	<input type="checkbox"/>	-	-	0	AEM 5 GearPos 5.png 121x38 2.63 KiB
6	6	<input type="checkbox"/>	-	-	0	AEM 5 GearPos 6.png 121x38 2.87 KiB

The example to the left shows how you can use a graphics selector to display gear position information using different graphics images.

Channels Tab

Basic Layout

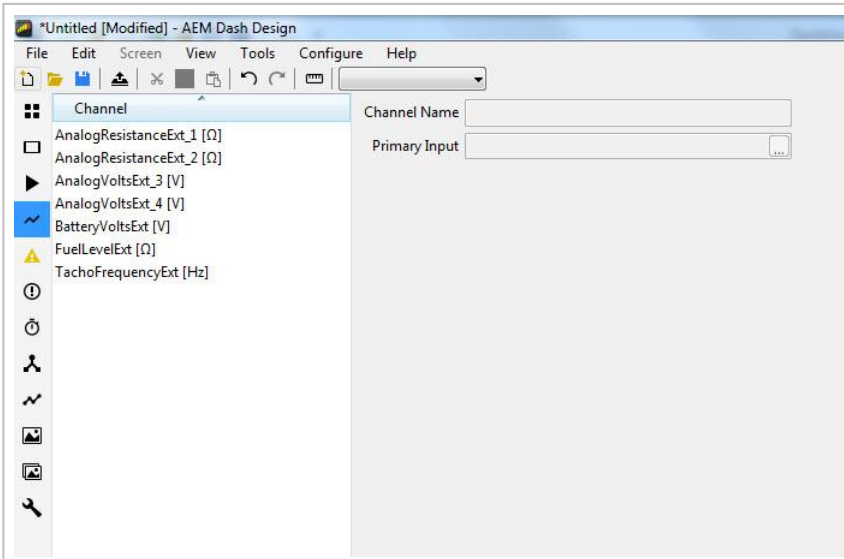

The Channels Tab is where all channel configuration is done if not related to CAN messages definitions. CAN definitions are created and edited in the CAN Tab. The example at left shows a very basic setup with only 7 channels defined. This is an example of an AEM 30-2226 6 Channel CAN Sensor Module.

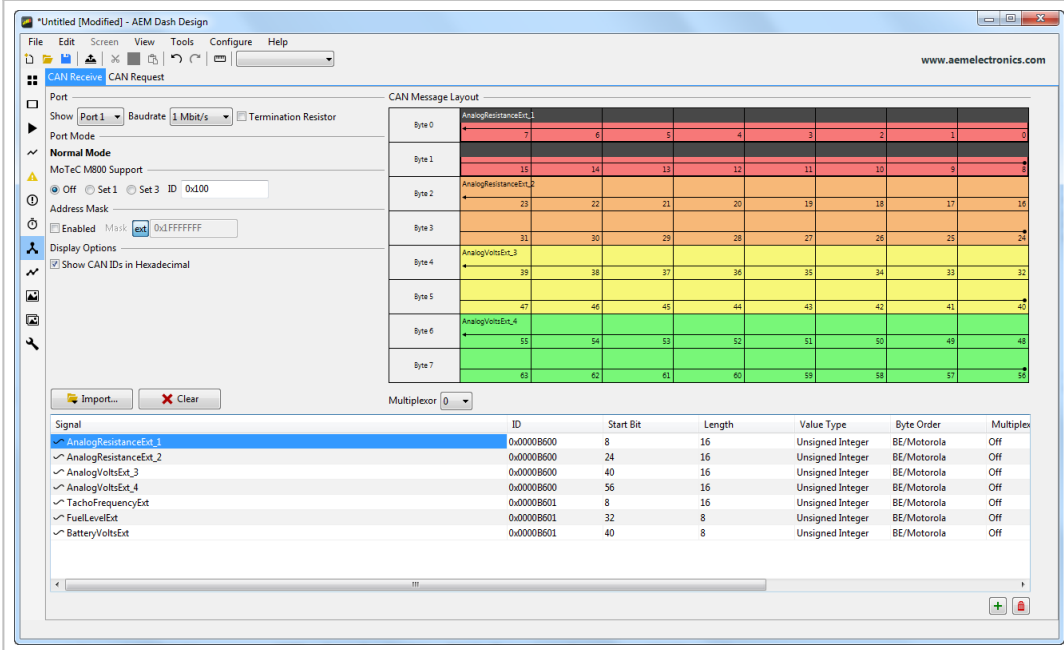

The example at left shows how this setup would look on the CAN Tab.

CAN Channel Selected

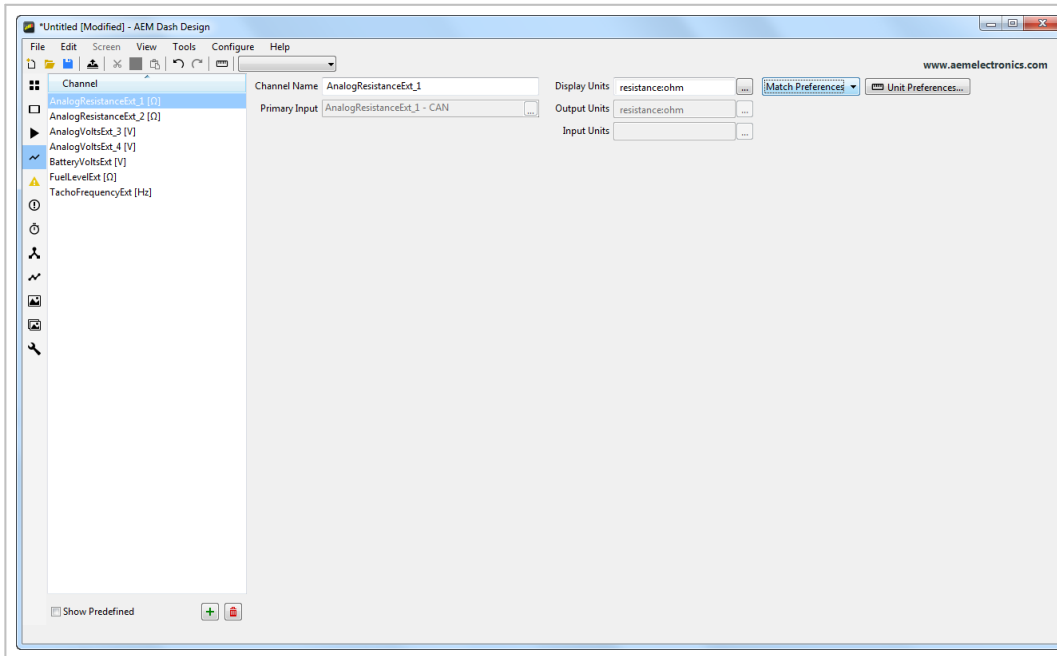

With a CAN message channel selected, two attributes are editable. The channel name can be changed as well as the display units. Selecting *Override Default Units* will present the user with a list of alternative units as shown in the example below.

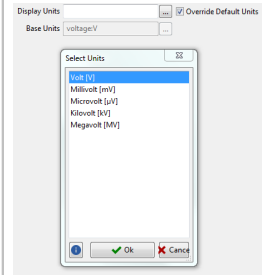

User Channel - Library

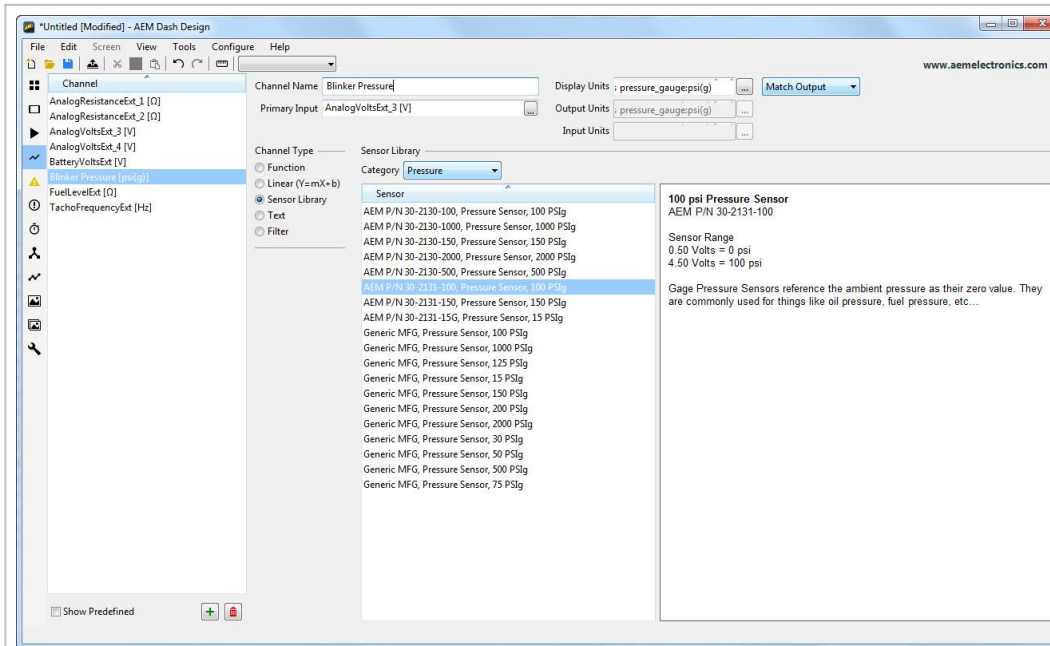

A new channel can be defined by selecting from a list of available library sensors. This is most often used when you have a common sensor type connected to an existing channel that has some sort of raw data in it, either volts, ohms, frequency etc...

For this example, imagine you are receiving a voltage value from some external device over CAN and that voltage is the output from a pressure sensor and you want to see the pressure value rather than volts.

Start by adding a new channel and selecting the "Sensor Library" channel type.

Type in a Channel Name for the new channel. In this example the new channel will be named *Blinker Pressure*.

Select which channel will be used as the Primary Input for this new channel. In this example, the existing channel *AnalogVoltsExt3* has been selected.

From the available list of sensors, select the correct sensor whose calibration you want to apply to the Primary Input channel. In this case, we have selected a specific AEM 100 PSIg sensor.

Once the sensor is selected, the Base Units and Display Units fields will show a unit type. If you wish to change the display units you can select a different one from the drop down menu next to Display Units.

User Channel - Linear

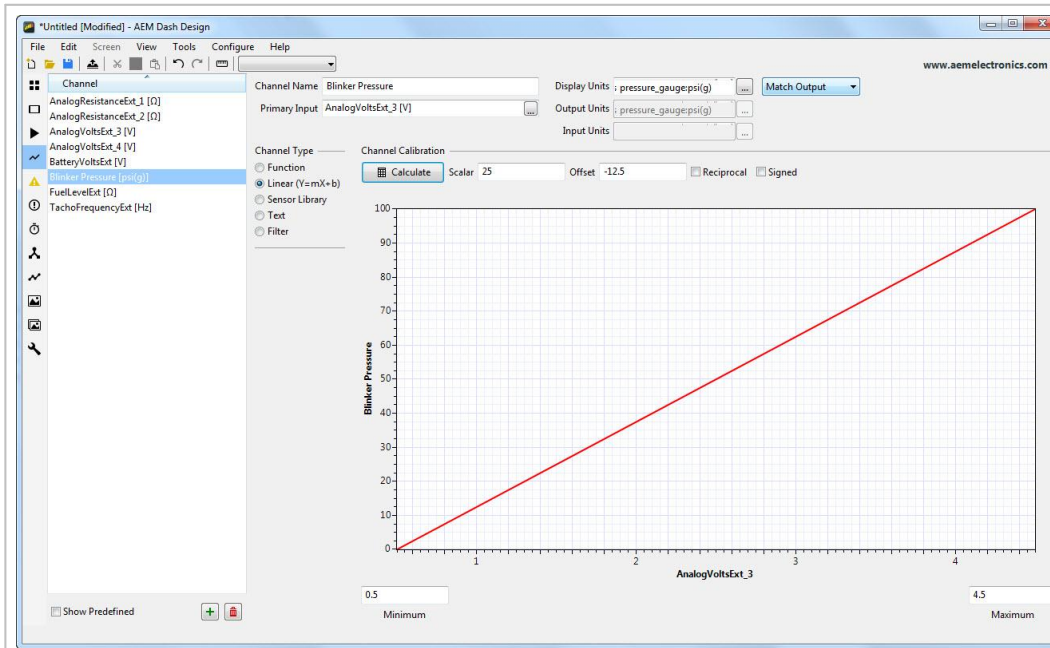

A custom linear channel can be created following the example at left.

This is most often used when you want to re-scale an existing channel and the relationship is linear.

The new channel will be scaled with the equation $Y=mX=b$

Where the Output = Input*(Scalar) + Offset

The optional *Calculate* feature automatically calculates the proper scalar and offset based on two data points.

The 'Calculate Scaling Function' dialog box shows the input and output values used for the scaling calculation. The input (X) values are 0.5 and 4.5, and the output (Y) values are 0 and 100. The resulting equation is $Y = (25 * X) + -12.5$.

Input (X)	Output (Y)
0.5	0
4.5	100

$Y = (25 * X) + -12.5$

In the example above, a sensor with a voltage output range of 0.5 to 4.5 volts has a calibration range of 0 to 100 psi.

User Channel - Function

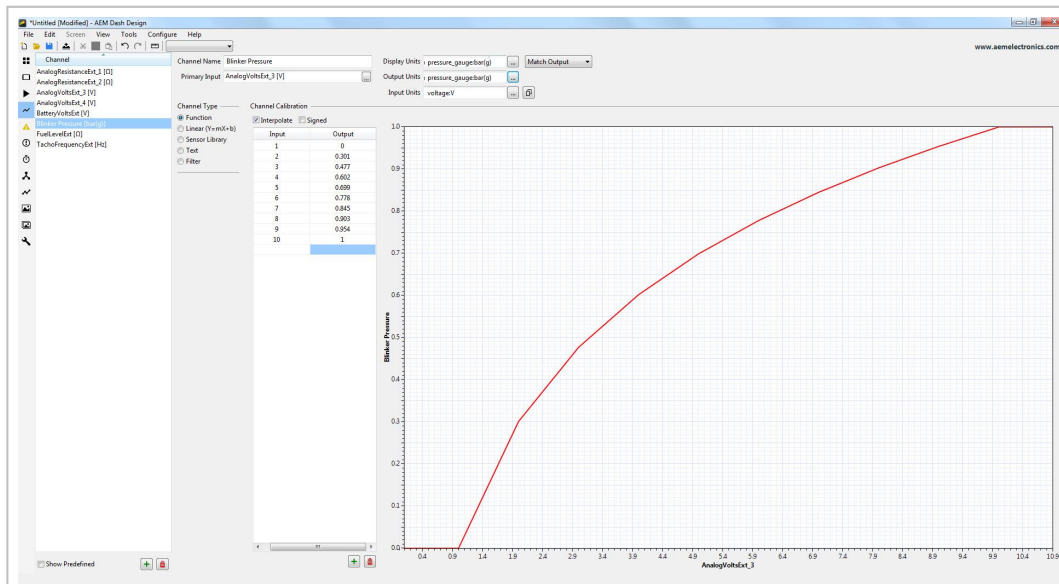

A custom function channel can be created following the example at left.

Start by typing in a Channel Name for the new channel. In this example, the new channel will be named *Blinker Pressure*.

Select the Base Units this channel will be calibrated in. For this example, the channel will be defined with the units of *Bar (gauge)*

Select which channel will be used as the Primary Input for this new channel. In this example, the existing channel *AnalogVoltsExt3* has been selected.

Manually enter the input and the corresponding outputs that will drive this new channel. In the example shown, when the value of *AnalogVoltsExt3* is 4, the value for *Blinker Fluid* will be 0.602 bar(g)

Add rows as needed. If the "Interpolate" box is left checked, the output value will be a linear interpolation between the closest 2 defined input points. So if the value of *AnalogVoltsExt3* is 1.5 the output value for *Blinker Fluid* will be calculated as 0.1505 bar(g).

User Channel - Channel Based Text

Channel Name: EngineSyncState_Text

Primary Input: EngineSyncState

Channel Type: Linear Non-linear Sensor Library Text Filter

Value	Text
0	NOT SYNC'D
1	SYNC'D

Advanced

+ - ↑ ↓

Text can be used to replace numeric values using the Channel Based Text feature. In the example at left, the input *EngineSyncState*, which will be either 0 or 1 depending on the state, is replaced by two text strings.

0 = NOT SYNC'D
1 = SYNC'D

These text strings can be displayed rather than the numeric value of the channel by using a [Dynamic Text Display](#) gauge

Timers Tab

The Timers Tab allows you to configure three different types of timers for your dash - performance, stopwatch, and count down.

Note: Timers will only function with firmware version 15x03 or higher.

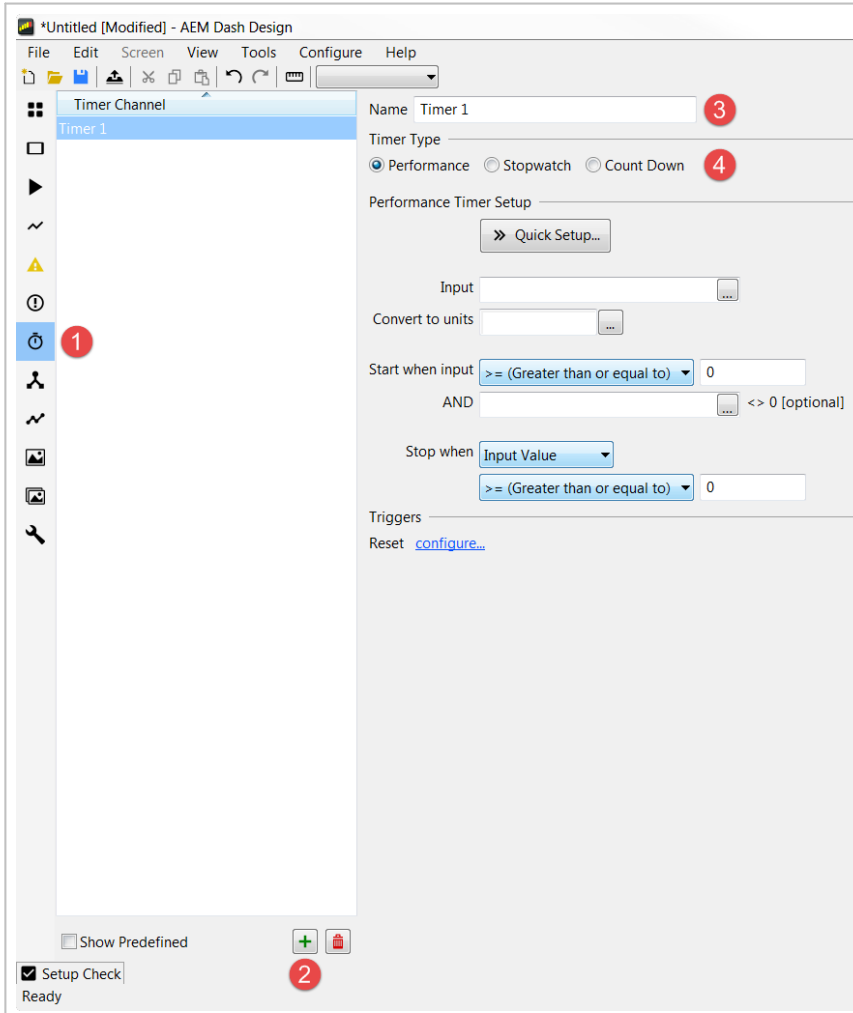

To add a new Timer Channel:

1. Click on the *Timers Tab*. It is the 7th tab down and the icon is in the shape of a stopwatch.
2. Click on the green plus sign located below the *Timer Channel* box. A new Timer Channel will appear in the list.
3. Rename the timer.
4. Select timer type.

Performance Timer

Performance timers can be used to measure various performance metrics, e.g. 0-60 MPH or 1/4 mile. Use the *Quick Setup* option for quick and easy setup of distance and speed range timers or create a custom performance timer by filling out the *Performance Timer Setup* fields.

Quick Setup

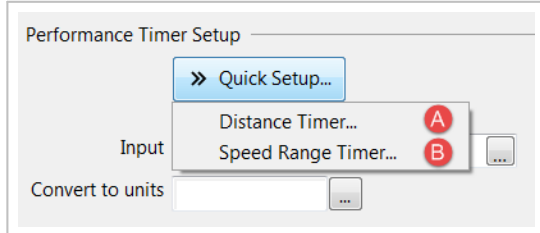
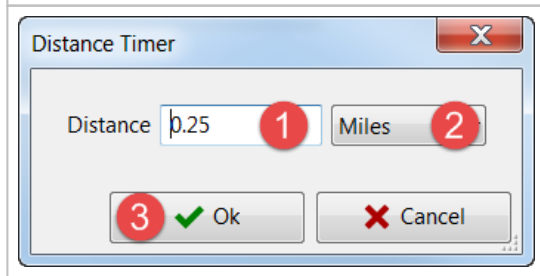
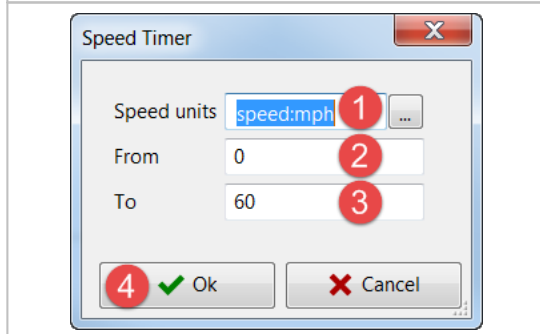
 <p>Performance Timer Setup</p> <p>Input <input type="text" value="0.25"/> <input type="text" value="Miles"/></p> <p>Convert to units <input type="text" value="..."/></p> <p>Buttons: >> Quick Setup... (A), Distance Timer... (B), Speed Range Timer... (B), ...</p>	<p>Click on the <i>Quick Setup</i> button and select one of the following:</p> <ul style="list-style-type: none"> A. Distance Timer. B. Speed Range Timer.
 <p>Distance Timer</p> <p>Distance <input type="text" value="0.25"/> <input type="text" value="Miles"/></p> <p>Buttons: Ok (3), Cancel</p>	<p>Distance Timer:</p> <ol style="list-style-type: none"> 1. Input the distance over which the timer is active. 2. Select desired distance unit of measure. 3. Click <i>Ok</i> to confirm.
 <p>Speed Timer</p> <p>Speed units <input type="text" value="speed:mph"/> <input type="text" value="..."/></p> <p>From <input type="text" value="0"/></p> <p>To <input type="text" value="60"/></p> <p>Buttons: Ok (4), Cancel</p>	<p>Speed Timer:</p> <ol style="list-style-type: none"> 1. Click the three dots next to <i>Speed units</i> to select desired speed unit of measure. 2. Input the speed at which the timer starts. 3. Input the speed at which the timer ends. 4. Click <i>Ok</i> to confirm.

Performance Timer Setup

Name

Timer Type

Performance Stopwatch Count Down

Performance Timer Setup

[» Quick Setup...](#)

Input ... **1**

Convert to units ... **2**

Start when input **3** **4**

AND **5**

Stop when **6**

7 **8**

Triggers

Reset [configure...](#) **9**

Performance Timer Setup Instructions:

1. Click the three dots to select input channel to use for performance timer.
2. Click the three dots to select units to convert to, if applicable. Otherwise, use same units as input units.
3. Click the dropdown to select the comparison operator for the timer start condition.
4. Input the value used for timer start condition. This value corresponds to the selected input channel and is unit aware.
5. Optional: If multiple start conditions are desired, select additional input channel. Otherwise, leave blank. If more than two conditions are desired, create alarm channel with all desired conditions to be met.
6. Click the dropdown to select the mathematical operation to perform on the input. The descriptions for the options are below:
 - o Input value - No calculation on input value. Use this option for a speed range timer with an input of vehicle speed.
 - o Integrated value - Integrates the input. Use this option for a distance timer with an input of vehicle speed.
 - o Summed value - Add the current input value to an internal sum if the input sample time increases. This is similar, but not the same to the Integrated mode (i.e. summation as opposed to integral). This would be used where the summed quantity is the same as the input, e.g. summing small piece-wise distance values to obtain a total distance.
 - o Value offset - Takes the input value when the timer started and subtracts from the current value. The result of that is used for comparison with the stop limit.
7. Click the dropdown to select the comparison operator for the timer stop condition.
8. Input the value used for timer stop condition. This value corresponds to the selected input channel and is unit aware.
9. Configure the trigger for the timer. See *Triggers* section below for more info.

Stopwatch Timer

Name

Timer Type

Performance Stopwatch Count Down

Triggers

Start [configure...](#)

Stop [configure...](#)

Reset [configure...](#)

Stop until reset [configure...](#)

Toggle [configure...](#)

The stopwatch timer is a manually triggered timer. See *Triggers* section below for more info on how to configure the triggers.

Count Down Timer

Name

Timer Type
 Performance Stopwatch Count Down

Initial Value

Hours	Minutes	Seconds	Milliseconds
<input type="text" value="0"/>	<input type="text" value="0"/>	<input type="text" value="0"/>	<input type="text" value="0"/>

Triggers

Start [configure...](#)

Stop [configure...](#)

Reset [configure...](#)

The count down timer counts down from an initial value. Input the time to start the count down from under *Initial Value*. See *Triggers* section below for more info on how to configure the triggers.

Triggers

Triggers

Start [configure...](#)

Stop [configure...](#)

Reset [configure...](#)

Stop until reset [configure...](#)

Toggle [configure...](#)

Triggers are used to start, stop, or reset a timer through the use of either the reset button or an alarm channel input. Each timer type has different types of triggers available. Click *configure* to setup the trigger of choice.

Note: The *toggle* trigger type allows use of the same input to start and stop a timer. If the same input is assigned to both the *start* and *stop* triggers, the timer will not function because it is simultaneously trying to start and stop the timer at the same time.

Select Start Trigger

Button Triggers

Reset Button

Channel Trigger

Alarm Input

Reset Button Trigger Options:

- Click - Single click.
- Long Click - Fires when button released after having been held for at least 1.5 seconds.
- Hold - Fires when button has been held for 1 second. This event will also repeat every 0.25 seconds after that and will also accelerate in frequency the longer the button is held down. This behavior is useful for menu buttons / value adjusters etc.
- Long Hold - Fires when button has been held down for 3 seconds and not released yet.

Alarm Channel Input:

Select an alarm channel for use with the trigger. See the *Alarm Tab* section of the *User Guide* for more info on how to setup alarm channels.

Screens Tab

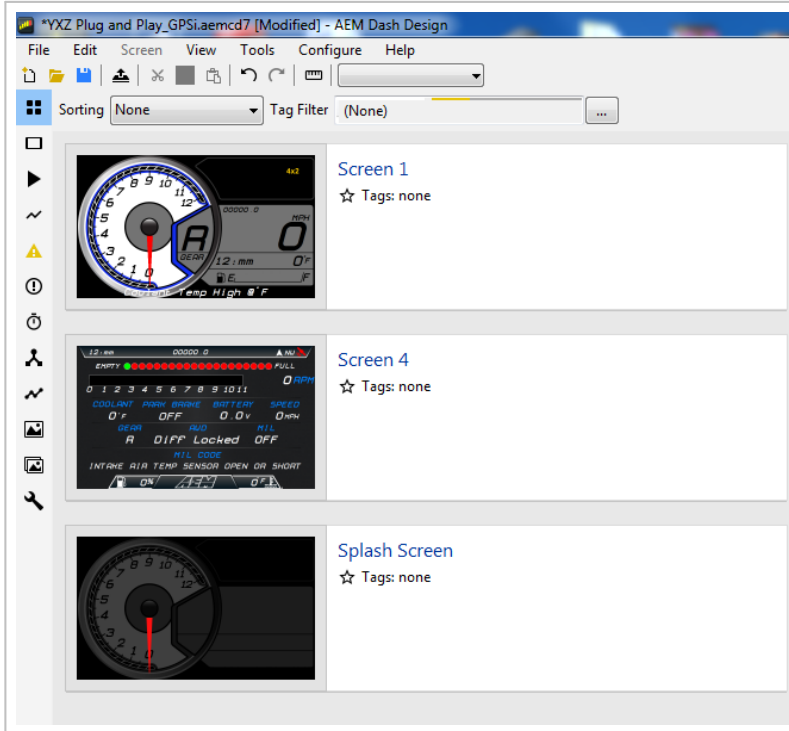

The screens tab provides a visual overview of all screens used in the setup. Double click a screen to enter design mode.

Design Tab

Screen Editing

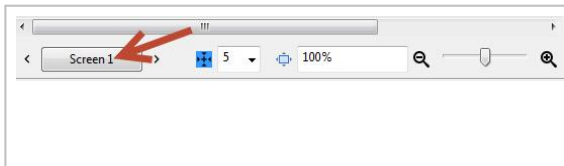

Select the screen by clicking the Screen button. A selection dialog will be presented allowing screen selection for editing. Alternatively, use the arrow keys to cycle through each. The selected screen will be displayed in the main window for editing.

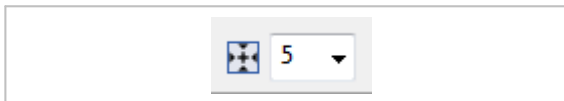

Enables snap to grid. Select from the menu to configure the snap grid size.



Displays the current zoom level. Drag the pointer or click the icons to select a zoom level for the main window.

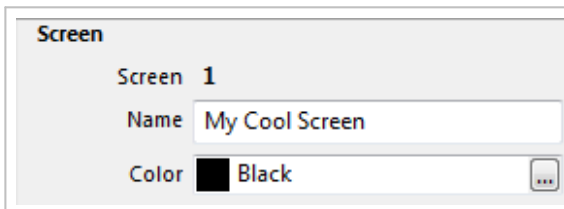

Displays the number or type of screen page, provides a text box for an optional user name and allows the user to select the screen background color.

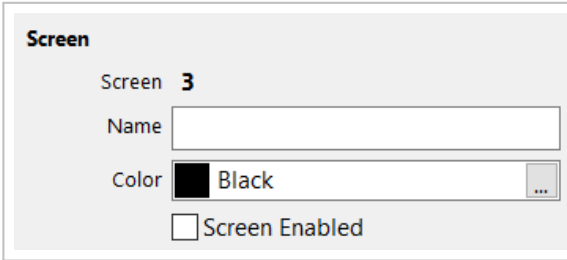

On Screens 3 & 4, the "Screen Enabled" check box allows the user to show/hide that screen.

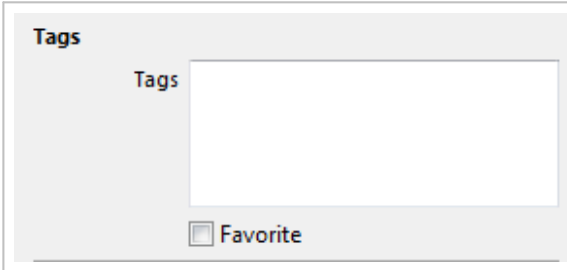

Tags can be helpful for organizing screens in the import screen dialog. Left click inside the field then select the icon to edit tag definitions. Click the icon to add a new tag to the list. Click the icon to remove a tag from the list. Once the tags are created, they can be assigned to the screen by selecting them from the dialog or by simply typing into the text field. Closely matching tags will be filtered for selection.

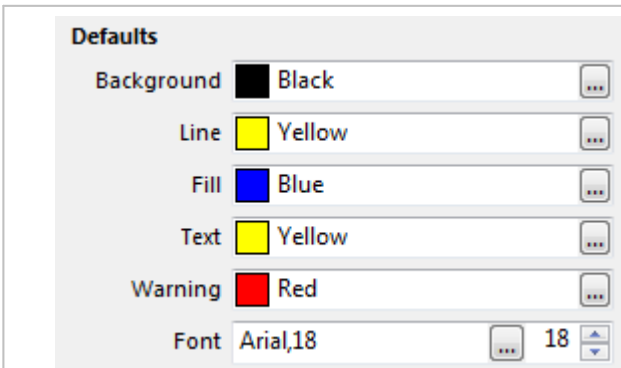



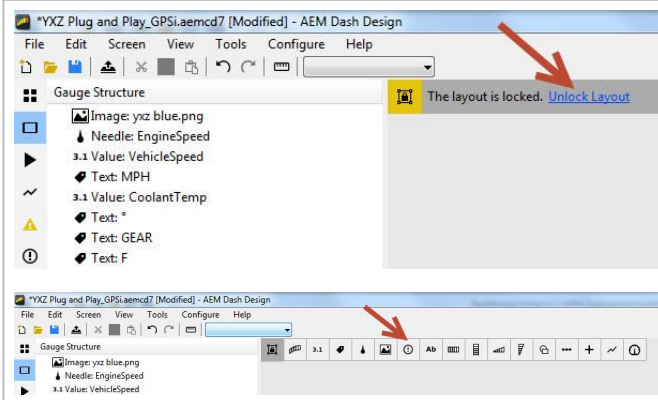







Gauge defaults are used when a new gauge is added to the selected screen. The default settings can be overridden in the individual gauge properties.



Screen editing tools are accessed by clicking *Unlock Layout*.

Following is a brief description of each gauge tool available for use in the Screens tab. Drag and drop onto the screen in the main window. The right pane will update to show configuration settings for each gauge.

	Vertical Triangular Bar Graph	Create a new Vertical Triangular Bar Graph. The gauges size, location, colors and scaling are configurable. The gauge can either display the value as a filled bar from the bottom, from the center or display the value as a single line.
	Horizontal Triangular Bar Graph	Create a new Horizontal Triangular Bar Graph. The gauge can either display the value as a filled bar from the side or filled from the center, or display the value as a single line. The gauges size, location, colors and scaling are configurable.
	Vertical Square Bar Graph	Create a new Vertical Square Bar Graph. The gauges size, location, colors and scaling are configurable. The gauge can either display the value as a filled bar from the bottom, from the center or display the value as a single line.

	Horizontal Square Bar Graph	Create a new Horizontal Square Bar Graph. The gauge can either display the value as a filled bar from the side, from the center or display the value as a single line. The gauges size, location, colors and scaling are configurable.
	Circular Tachometer	Create a new Circular Tachometer. Can be assigned to display any channel. The overall size and location can be set as well as the label font, size and format. The display scaling, and segment size can also be set. Colors can be specified for the background, border, labels and needle.
	Horizontal Tachometer	Create a new Horizontal Tachometer. Features progressive scaling and 3 definable color bands. Can be either a sweep or a horizontal style. The Input Channel, Scaling, Location and Colors are configurable.
	Numeric Value	Create a new Numeric Value. The Value gauge is a numeric display that shows the value of the specified channel according to the numeric format specified. It's Location, Font, Size, Justification and color can be set. The Value gauge has an optional warning mode that changes the color of the gauge when a warning limit for the input is exceeded or is a specified alarm is active. Special numeric formats are also available to display system values. Examples of these values are the system time and date as well as display specific information such as firmware version, serial number, hour meter, reset counter, and current setup filename.
	Fixed Text Label or Caption	Create a new Fixed Text Label/Caption. The Text Label has no input and is used to label other gauges and provide non-changing information to the user. The actual text displayed, it's location, font, size, color, justification and direction can be configured. It can also be made to flash and/or change color under specified alarm conditions.
	Limiter Light Gauge	Create a new Limiter light gauge. The individual lights can be either square or circular. Typically used to signal an approaching limit by means of several boxes that change color as the limit approaches. The background and fill colors are configurable as well as their location, size, starting value and the offset.
	Static Image or Image Selector	Create a new Static Image or Image Selector. Used to show a graphic from a file or the output of a graphic selector. BMP, PNG or JPG image types are allowed but PNG's and JPG's may be preferable to reduce the size of the setup. A smaller setup has a faster boot time, page changes and frame update rate.
	Warning Bar	Create a new Warning Bar. The Warning Bar gauge is a block that changes color depending on its input. Typically this is used to indicate out-of-range parameters. For example, a Warning Bar may be placed next to or behind a gauge showing coolant temperature. The input to the Warning Bar is configured to signal an error signal if the coolant temperature rises above a pre-determined level. The bar color changes from the specified background color to the Fill color to give an easily seen warning indication. It's location, size and colors are definable.
	Dynamic Text Display	Create a new Dynamic Text Display. The Dynamic Text display is a text display that shows the changing text based on the numeric value of the specified channel. It's Location, Font, Size, Justification and color can be set. The Dynamic Text Display has an optional warning mode that changes the color of the text when a specified alarm is active and can be made to flash as well. Typical uses for the Dynamic Text is for PRNDL gear notifications rather than just numbers, also for item status updates in a natural language rather than status codes, i.e. "AFR Sensor 1 Low Volts" rather than Failure Status Code = 22.
	Fixed Shape Display	Create a new Fixed Shape. Can be either a Square, Rectangle, Circle or Ellipse. The size, location, border and fill colors are configurable.
	X-Y Cross Hair Gauge	Create a new X-Y cross-hair gauge. The X-Y Cross Hair Graph plots a cursor on a graph with the vertical and the horizontal location of the cursor is determined by user definable channel inputs. The X & Y Input Channels, cursor size, scaling, location and cursor appearance are configurable. A background image can also be specified to give context to the data.

	Graph/Strip Chart	Create a new Graph/Strip Chart. The Graph is a strip recorder type historical graph that shows trends of one or more outputs in the form of a Value vs Time graph. The charts time base, it's location and size is configurable. The number of channels, their individual scaling and colors are also configurable.
	Floating Needle	Create a new Floating Needle. Adds a programmable needle element that can be placed over a background image to create a custom gauge. The Needle center point, it's sweep definitions, color and shape are fully definable.

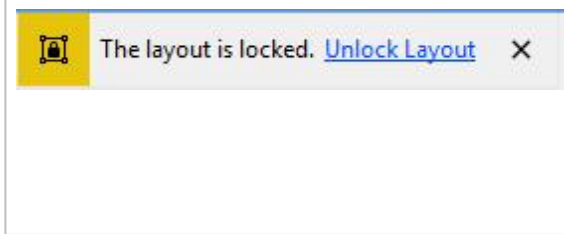

The Layout Locked feature can be enabled by going to File | Lock Layout. Disable by going to File | Unlock Layout or click the *Unlock Layout* toggle shown or right click and select Unlock Layout.

Caution as inadvertent clicks and drags can move items unintentionally. Some basic editing of the default screens is possible even with the Layout Locked feature turned on. It is a good idea to leave Layout Locked activated until you specifically need to move or delete a gauge. Having it on prevents you from accidentally moving a gauge or deleting one inadvertently.

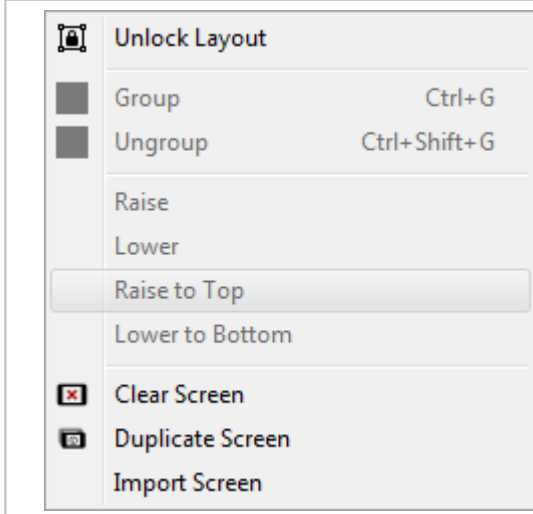

Additional right click menu options include Clear Screen, Duplicate Screen and Import Screen. These are also accessible from the Screen menu.

Clear Screen removes all items from the current screen.

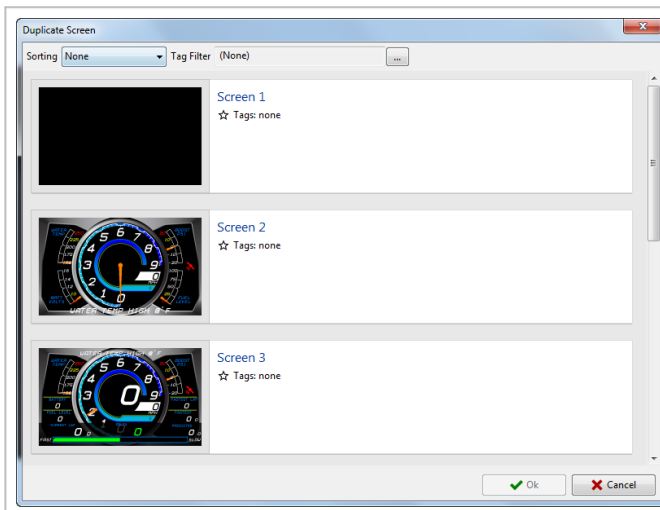

Duplicate Screen launches a dialog that allows you to copy all items from any screen in the setup to the current screen.

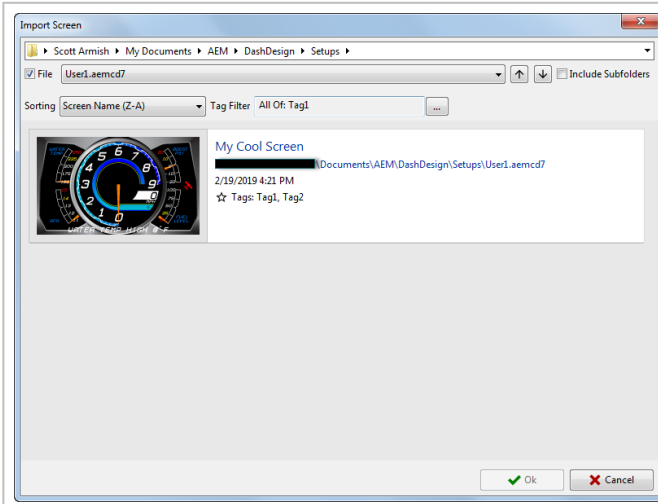

Similar to Duplicate Screen, Import Screen replaces all items in the current screen with items from any screen that exists within any setup on your PC.

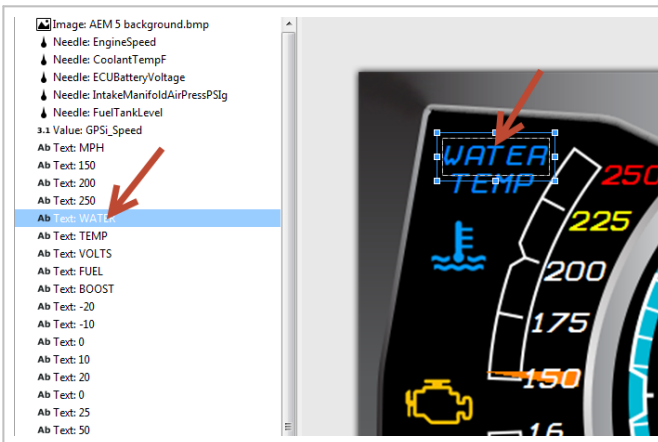

Clicking on a gauge item in the list will highlight it on the screen. When the item is highlighted, gauge attributes will be displayed on the right hand pane for editing. Gauge elements can be cycled through using the keyboard shortcut keys *Alt+Left/Alt+Right*. The *Enter* key focuses on the properties grid, while *ESC* key moves focus back to the screen editor.

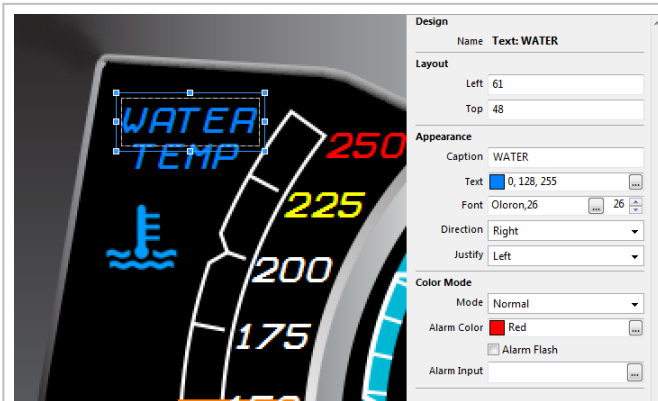

With an item highlighted, a right click menu is available. Four options are available to control the Z-order of the element. Z-order is the position of the element relative to other layers on the screen. Raise will move the item one layer closer to the top. Lower will lower the item one layer closer to the bottom. Raise to Top will send the item to the top layer above everything below it. Lower to Bottom will send the item to the lowest layer.

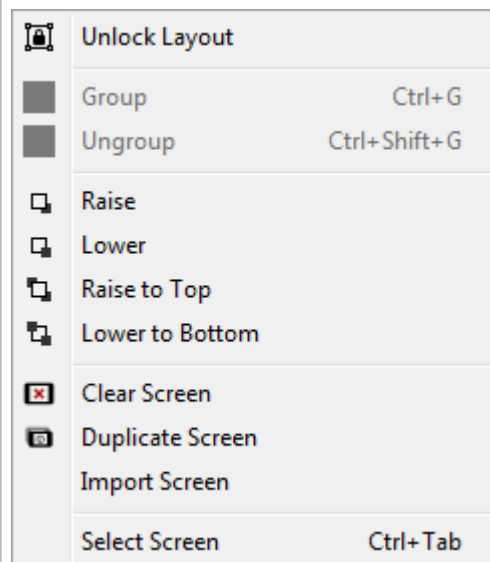

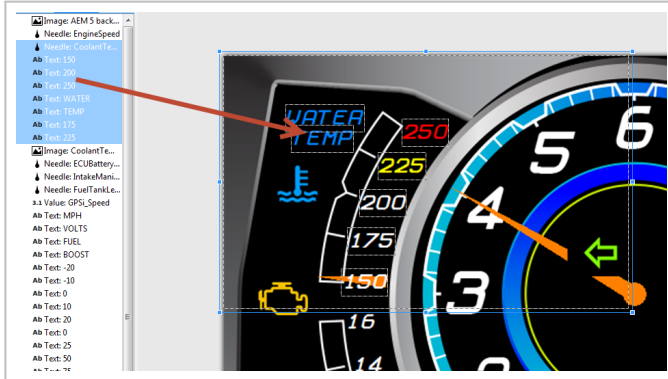

Hold the Ctrl key and left click to select individual gauge elements or hold the Shift key and left click the beginning and end of a sequential list. Once you have the items selected, right click to group them.



Once the new group is created, its name and position can be edited in the right hand pane. The group can be collapsed if desired in the left hand pane to minimize clutter in your gauge list. Select an item within the group then right click. This will allow you to change the Z-order of that item within the group.

Alarm Screen

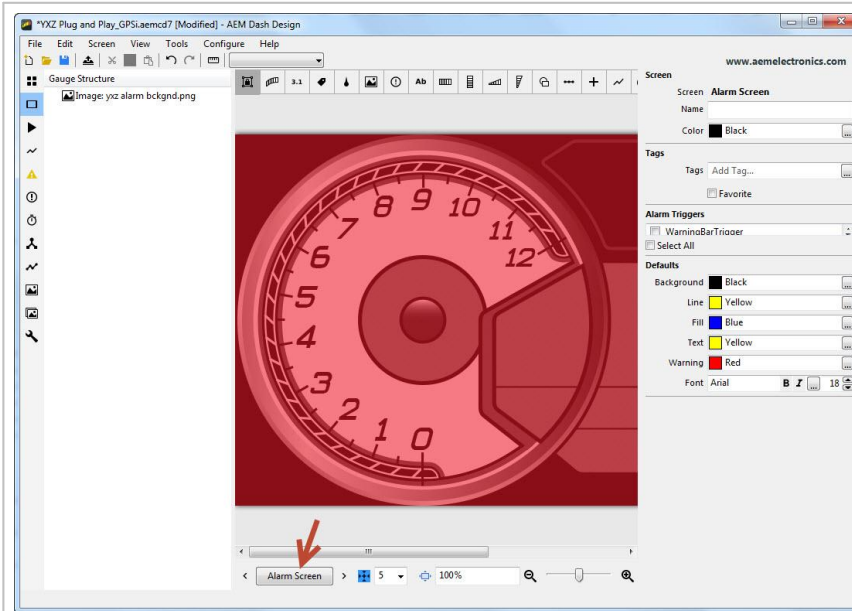

The alarm screen is triggered when user defined alarm triggers are activated.

The alarm page editor will include a list of available alarm triggers. Select which ones you want to trigger the alarm page.

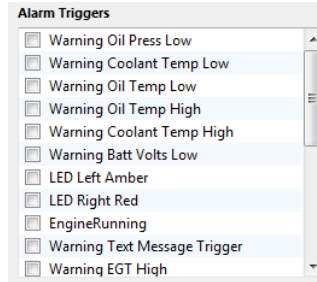

Once this page is triggered, it will remain displayed until the user presses the left button. This will revert the display back to the page that was being displayed before the alarm page was triggered.

We recommend triggering this page only when there is a very serious issue that requires the driver to take an immediate action. Simply informing the driver of a situation to monitor is likely better accomplished with a basic warning text message as those may not as dramatically interrupt the driver's focus nor force the driver to take action to get back to the normal screen.

The Alarm page is intentionally disruptive to the driver so use it sparingly and ideally only as a last resort.

Edit History

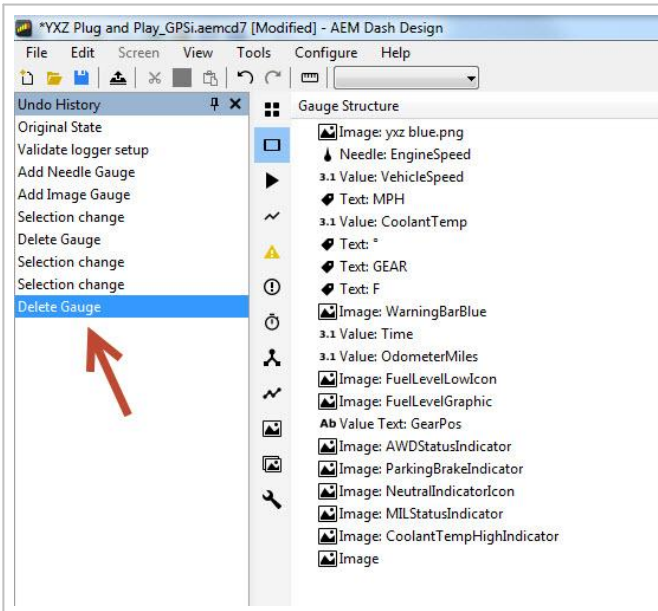

History displays a running log of recorded edits. Clicking in the list will highlight the edit on the screen. *Undo* or *Redo* commands with the history list open will be indicated by a blue bar that follows the history forward or backwards. If you step backwards by applying *Undo* commands and click outside the history list, all changes from that point forward will be deleted and the list will begin again from that point.

On Change Screen

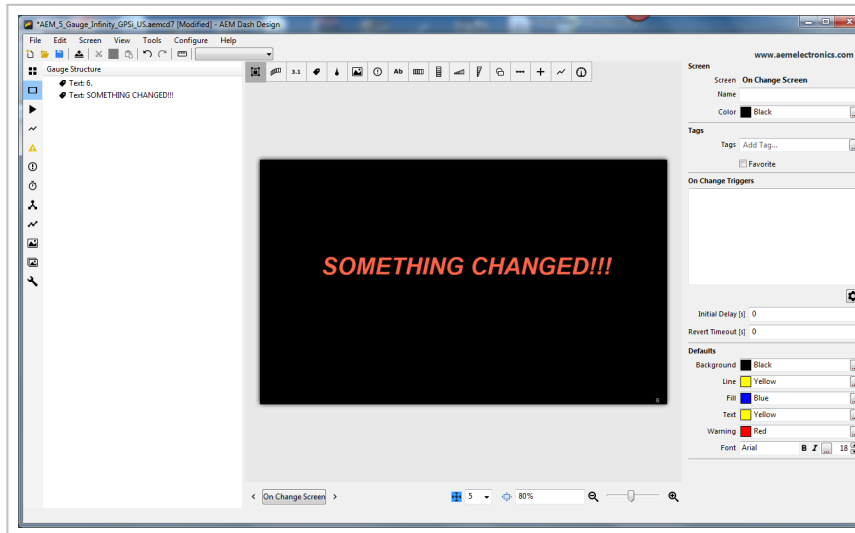

The On Change Page allows you to setup a custom page that will be displayed whenever any changes are detected on selected channels.

Click the  button to select page change trigger channels.

Initial Delay suppresses the on change function for this amount of time after a power up or a system reset. This allows connected devices to be up and running before changing outputs are acted upon.

The *Revert Timeout* is the time the on change page should continue to display after the trigger channel(s) have stopped changing. After this time has elapsed, the page will revert back to displaying the page that was being displayed when the on change was triggered.

Splash Screen

Splash Screen

Duration [s]

The splash screen is a special screen that is shown for a set period when the display starts; for showing a team logo for example.

Design the screen as normal then choose a display duration. The screen will display for this amount of time after power up.

Logger Tab

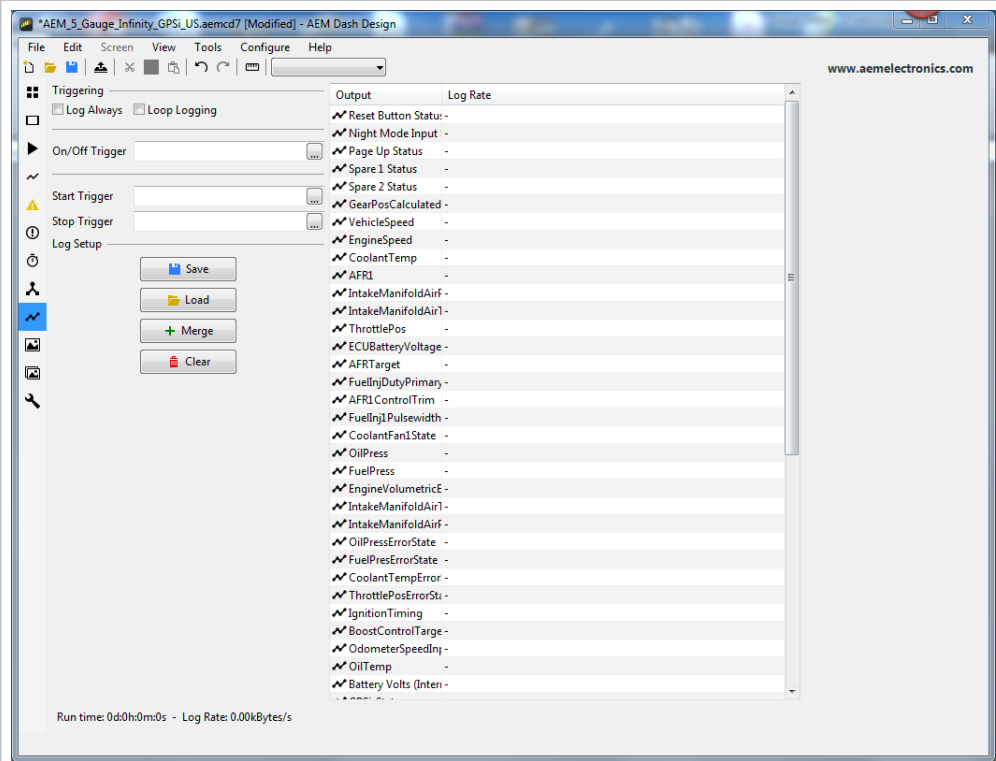

The Logger Tab contains all setup options for data logging. The Tab is only useful for logging enabled units.

Enable a channel for logging by selecting a Log Rate.



The Run time indicator will update to show how much logging time is available with the existing setup.

Run time: 6d:9h:18m:2s - Log Rate: 0.37kBytes/s

Triggering/Log Always if checked, data will be logged constantly regardless of conditions.

Triggering/On/Off Trigger - select a channel for the log trigger. If the channel is non-zero, data will be logged.

Triggering/Start Trigger - if non zero, the log will be started.

Triggering/Stop Trigger - if non zero, the log will be stopped.

Log setup files can be saved and managed using

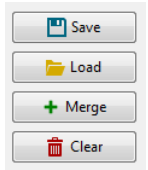

Simulate Tab





The simulate tab features an interactive simulation of dash operation using the open setup file.

To begin a simulation session:

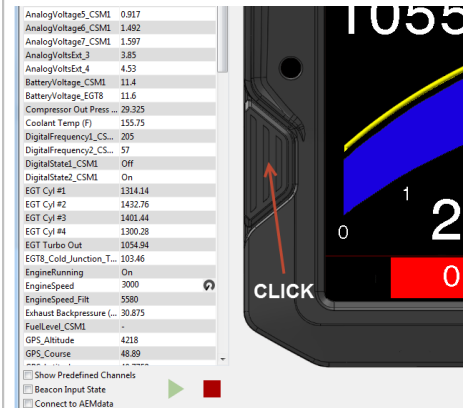
1. Click the  button. The simulator will boot up and function exactly the same as real dash hardware.
2. Click the virtual left/right buttons to interact just like the real dash. This includes warnings, alarms and on change page functionality.



3. Type values into the channel list or interact with the  icon to simulate data. Note, the data values available to be simulated will adhere to the channel resolution defined by the CAN channel the data is based on. For example, if the EngineRPM value comes over CAN with a minimum resolution of 1 RPM, then typing 2,544.36 as the engine RPM will cause the system to round it down to 2544 as the data value for this specific channel is limited to a resolution of 1 RPM by the underlying CAN source of the data.
4. Click the  button to end the simulation.

The simulator can be synchronized with AEMdata to tie the simulator channels to actual logged data.

1. Launch AEMdata and open a log file.
2. The simulator will display the data from channels whose names match those in the log file. The cursor position in the log file will determine what values are used in the simulator.

Utilizing the playback function in AEMdata allows the data to play and loop automatically in real time. This allows you to visualize actual logged channel data on the dash in the simulator. All automatic alarms, warning, page changes, etc. will function as programmed in the current dash setup. Changing the conditions in the setup that trigger these automatic events will result in new dash actions showing how the dash would have acted to the data with the new threshold conditions.

Gauge Reference

Numeric Value

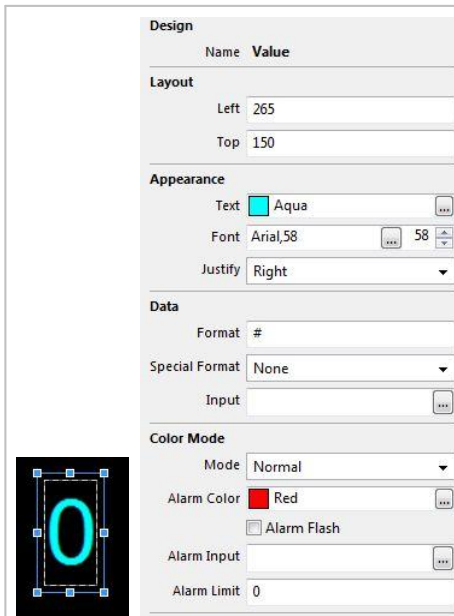

Name	Value
Left	265
Top	150

This gauge type is used to display changing numeric values.

Design/Name is the name of the gauge.

Layout/Left is the horizontal (X) location of the left side of the gauge in pixels
Layout/Top is the vertical (Y) location of the top of the gauge in pixels

Appearance/Text is the color of the text

Appearance/Font defines the font and size

Appearance/Justify is the alignment of the text. It can be left, right or centered.

Data/Format specifies the numeric formatting of the displayed value.

Data/Special Format -

A value other than NONE will show the relevant internal system channel value.

Setting any Special Format automatically uses the correct system variable to source the data to be shown and the Input channel is ignored.

Serial Number displays the units serial number as "Serial number: xxx".

Version Number displays the firmware version as "Version: ##X##".

Log Support reports the internal loggers current operating mode.

"Logging not Supported" This firmware does not support logging.

"Logging Stopped" The device is not currently logging.

"Logging Running" The device is currently logging.

"Log Looped" The log has looped.

"Log Memory Space Low" There is less than 5% of the memory remaining.

"Log Memory Full" The logging memory is full and logging has stopped.

"Log Initializing" The logger is currently processing the setup.

"Log Setup Error" There is a problem with the logger setup.

"Log Overrun" Reduce the # of channels or the screen complexity.

"Log Memory Worn" Flash worn, Log will continue at reduced capacity.

Usage Hours reports the total time used in the format of "Used: XX hrs".

Reset Count reports the number of dash reset cycles as "Reset Count: XX".

File Name returns the currently loaded setup file in the dash.

Frame Rate reports the current frame redraw rate as "fps:xx".

Processor Speed is not available on all displays.

FRAM size reports the size of the Flash RAM as "FRAM xxxKb".

Data/Input defines the input channel to display with this gauge.

Color Mode/Mode - selects the secondary color mode of the gauge.

Normal Mode - No secondary color is used.

Alarm Mode - If the gauge is in Alarm mode, the color of the gauge will change to the Alarm Color when the Alarm Input is equal to 1.

Limit Mode - *Value Gauges only* If the gauge is in Limit mode, the gauge alarm color will be used when the value of the gauge channel exceeds this value.

Color Mode/Alarm Color is the color the gauge will be displayed in if the alarm is active

Color Mode/Alarm Flash if checked, the gauge will flash if the alarm is active

Color Mode/Alarm Input - If the gauge is in Change on Alarm mode, the gauge alarm will be active if this input is true. If the gauge is in direct drive mode, the value of this input will be used as the RGB color of the gauge.

Color Mode/Alarm Limit - If the gauge is in Change on Limit mode, the gauge alarm will be active if the gauge input exceeds this value.

Fixed Text Label or Caption

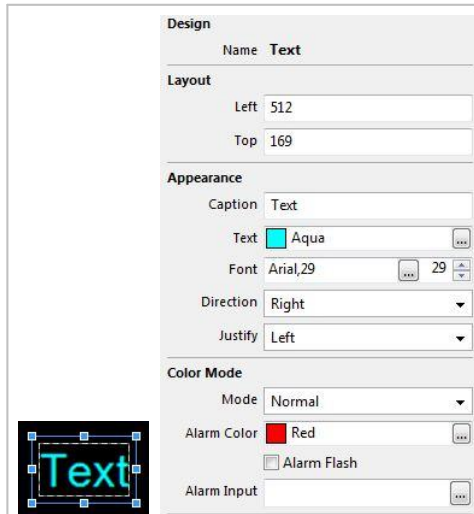

Design

Name **Text**

Layout

Left 512

Top 169

Appearance

Caption Text

Text Aqua

Font Arial, 29 29

Direction Right

Justify Left

Color Mode

Mode Normal

Alarm Color Red

Alarm Flash

Alarm Input

This gauge type is used to display fixed text labels.

Design/Name is the name of the gauge.

Layout/Left is the horizontal (X) location of the left side of the gauge in pixels
Layout/Top is the vertical (Y) location of the top of the gauge in pixels

Appearance/Caption is the caption text

Appearance/Text is the color of the text

Appearance/Font defines the font and size

Appearance/Direction is the direction of the text (right, left, up or down)

Appearance/Justify is the alignment of the text. It can be left, right or centered.

Color Mode/Mode - selects the secondary color mode of the gauge.

Normal Mode - No secondary color is used.

Alarm Mode - If the gauge is in Alarm mode, the color of the gauge will change to the Alarm Color when the Alarm Input is equal to 1.

Limit Mode - *Value Gauges only* If the gauge is in Limit mode, the gauge alarm color will be used when the value of the gauge channel exceeds this value.

Color Mode/Alarm Color is the color the gauge will be displayed in if the alarm is active

Color Mode/Alarm Flash if checked, the gauge will flash if the alarm is active

Color Mode/Alarm Input - If the gauge is in Change on Alarm mode, the gauge alarm will be active if this input is true. If the gauge is in direct drive mode, the value of this input will be used as the RGB color of the gauge.

Color Mode/Alarm Limit - If the gauge is in Change on Limit mode, the gauge alarm will be active if the gauge input exceeds this value.

Floating Needle

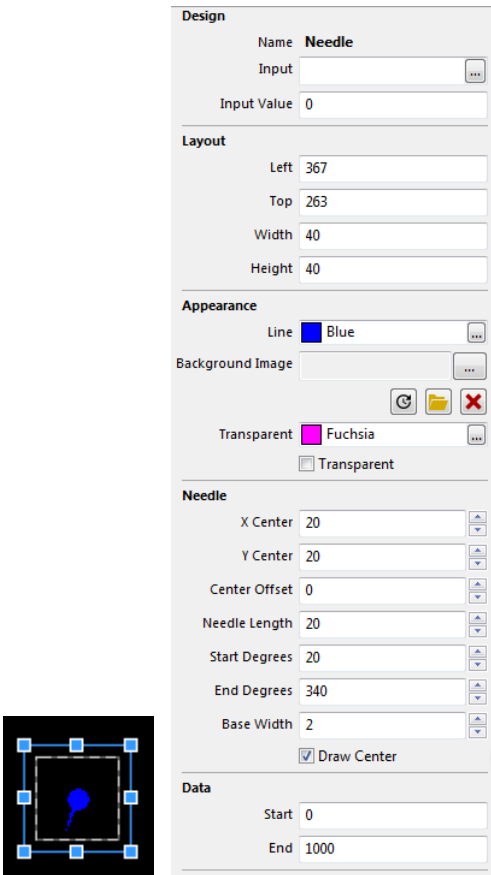

Design

Name **Needle**

Input

Input Value 0

Layout

Left 367

Top 263

Width 40

Height 40

Appearance

Line ■ Blue

Background Image

Transparent ■ Fuchsia

Transparent

Needle

X Center 20

Y Center 20

Center Offset 0

Needle Length 20

Start Degrees 20

End Degrees 340

Base Width 2

Draw Center

Data

Start 0

End 1000

This gauge is used to place a fully definable moving needle on top of a fixed graphics background.

Design/Name is the name of the gauge.

Design/Input is the input channel for the gauge

Design/Input Value is a preview value to be used for screen design and setup

Layout/Left is the horizontal (X) location of the left side of the gauge in pixels

Layout/Top is the vertical (Y) location of the top of the gauge in pixels

Layout/Width is the width of the gauge in pixels

Layout/Height is the height of the gauge in pixels

Appearance/Line is the color of the lines on the gauge

Appearance/Background Image is the optional background image to display

Appearance/Transparent is the transparency mask color. Select check box to enable.

Needle/X Center is the horizontal (X) position of the center of rotation of the needle, in pixels. Measured from the left side of the needle gauge item. Note: this center of rotation does not have to be within the limits of the gauge or even the overall screen dimensions. It many cases it may need to be far outside the normal screen window to get the gauge shape desired.

Needle/Y Center is the vertical (Y) position of the center of rotation of the needle, in pixels. Measured down from the top of the gauge item. Note: this center of rotation does not have to be within the limits of the gauge or even the overall screen dimensions. It many cases it may need to be far outside the normal screen window to get the gauge shape desired.

Needle/Center Offset is the distance from the center of rotation of the needle to the location where the inside of the needle starts, in pixels. Note: this center of rotation does not have to be within the limits of the gauge or even the overall screen dimensions. It many cases it may need to be far outside the normal screen window to get the gauge shape desired. If the value entered is negative, the needle will also draw a "tail" on the needle as well.

Needle/Needle Length is the length of the needle in pixels

Needle Start Degrees is the start angle of the needle, in degrees.

0 deg is down (6 o'clock)

90 deg is left (9 o'clock)

180 deg is up (12 o'clock)

270 deg is right (3 o'clock).

Needle/End Degrees is the end angle of the needle, in degrees.

0 deg is down (6 o'clock)

90 deg is left (9 o'clock)

180 deg is up (12 o'clock)

270 deg is right (3 o'clock).

Needle/Base Width is the width of the base of the needle in pixels.

Needle/Draw Center will draw a circle at the center of the needle.

Data/Start is the starting channel value to display with the needle

Data/End is the maximum channel value to display with the needle.

Horizontal Tachometer

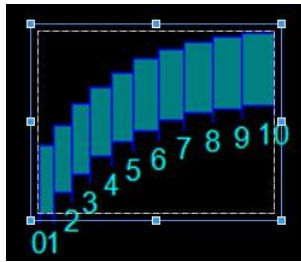

Design

Name **Bar Tacho**

Layout

Left 130

Top 135

Width 130

Height 100

Appearance

Line

Background

Fill

Label Color

Label Font Arial,18

Rectangular Tacho

Separators Between Bars

Smooth Edges

Data

Input

Start 0

End 10

Segment Size 1

Format #

Label Frequency 1

Label Divisor 1

Lower Limit

Lower Limit Enabled

Lower Limit End 0

Lower Limit Color

Upper Limit

Upper Limit Enabled

Upper Limit Start 1000

Upper Limit Color

Flash

Lower Limit Flash

Upper Limit Flash

Flash All Enabled

Flash All Start 1000

Flash Rate 500

Preview

Input Value 0

This gauge is used to display a horizontal bar graph in either an arc styled sweep or a basic rectangle, with increasing weight given to the higher values.

Design/Name is the name of the gauge.

Layout/Left is the horizontal (X) location of the left side of the gauge in pixels

Layout/Top is the vertical (Y) location of the top of the gauge in pixels

Layout/Width is the width of the gauge in pixels

Layout/Height is the height of the gauge in pixels

Appearance/Line is the color of the lines on the gauge

Appearance/Background is the color of the background sections of the gauge when it is in its base configuration

Appearance/Fill is the color of the filled or active sections of the gauge

Appearance/Label Color is the color of the labels on the gauge

Appearance/Label Font is the font used for labels

Appearance/Rectangular Tacho makes the tach a rectangular design instead of an arc based design

Appearance/Separators Between Bars draws separating lines between bars

Appearance/Smooth Edges - if on, makes the tacho bar edges smooth instead of stepped

Data/Input defines the input channel to display with this gauge.

Data/Start defines the minimum display value for the gauge.

Data/End defines the maximum display value for the gauge.

Data/Segment Size is the numeric value represented by each individual segment.

Data/Format specifies the numeric formatting of the displayed value.

Data/Label Frequency is the frequency at which labels are drawn.

Data/Label Divisor - the label values will be the channel value divided by this number.

Lower Limit/Lower Limit Enabled defines an area at the lower limit of the gauge that can be colored differently than the rest of the gauge

Lower Limit/Lower Limit End - anything below this value will be colored in the lower limit color

Lower Limit/Lower Limit Color - the lower limit area color

Upper Limit/Upper Limit Enabled defines an area at the upper limit of the gauge that can be colored differently than the rest of the gauge

Upper Limit/Upper Limit Start - anything above this value will be colored in the upper limit color

Upper Limit/Upper Limit Color - the upper limit area color

Flash/Lower Limit Flash makes the lower limit area flash when the display value is below the lower limit

Flash/Upper Limit Flash makes the upper limit area flash when the display value is above the upper limit

Flash/Flash All Enabled makes the entire gauge flash in the upper limit color when the display value is above the Flash All Start value

Flash/Flash Rate is the rate, in milliseconds, at which regions of the gauge will flash if any of the flash modes are active. Values between 100 and 500ms are valid.

Preview/Input Value is the value to display on the gauge during setup.

Warning Bar

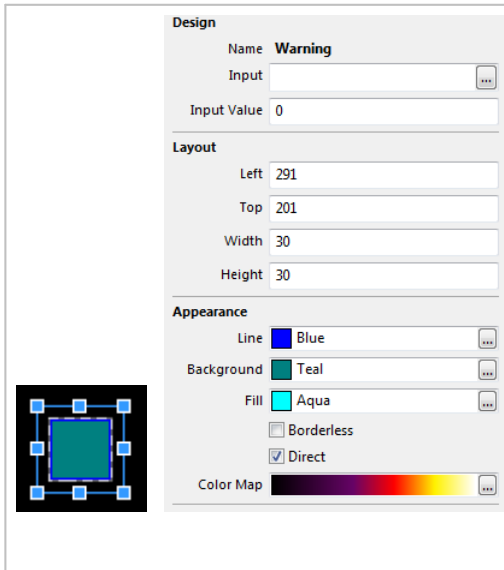

The image shows the configuration interface for a Warning Bar gauge. It includes a preview window on the left showing a square gauge with a teal background and blue border. The main configuration area is divided into three sections: Design, Layout, and Appearance.

Design

- Name: Warning
- Input: [text field]
- Input Value: 0

Layout

- Left: 291
- Top: 201
- Width: 30
- Height: 30

Appearance

- Line: Blue
- Background: Teal
- Fill: Aqua
- Borderless
- Direct
- Color Map: [color gradient bar]

This gauge type is used to create a color changing element, with either a simple color toggle being triggered by an alarm or as a "heat map" type display with the color display representing the channel value driving it.

Design/Name is the name of the gauge.

Design/Input is the input channel for the gauge.

Design/Input Value is the value to display on the gauge during setup.

Layout/Left is the horizontal (X) location of the left side of the gauge in pixels

Layout/Top is the vertical (Y) location of the top of the gauge in pixels

Layout/Width is the width of the gauge in pixels

Layout/Height is the height of the gauge in pixels

Appearance/Line is the color of the lines on the gauge

Appearance/Background is the color of the background sections of the gauge when it is in its base configuration

Appearance/Fill is the color of the filled or active sections of the gauge

Appearance/Borderless when selected will draw the gauge without a border

Appearance/Direct uses the input value as the color. No border is drawn in this mode.

Appearance/Color Map maps the input value to a color. This is very useful to make a Warning Bar into a heat map styled element

Dynamic Text Display

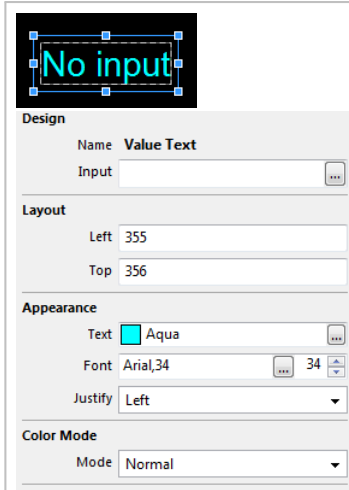

The image shows the configuration interface for a Dynamic Text Display gauge. It includes a preview window on the left showing a square gauge with the text "No input" in blue. The main configuration area is divided into three sections: Design, Layout, Appearance, and Color Mode.

Design

- Name: Value Text
- Input: [text field]

Layout

- Left: 355
- Top: 356

Appearance

- Text: Aqua
- Font: Arial, 34
- Justify: Left

Color Mode

- Mode: Normal

This gauge type is used to display changing text values that are determined by a value channel.

Design/Name is the name of the gauge.

Design/Input is the input channel for the gauge.

Layout/Left is the horizontal (X) location of the left side of the gauge in pixels

Layout/Top is the vertical (Y) location of the top of the gauge in pixels

Appearance/Text is the color of the text

Appearance/Font defines the font and size

Appearance/Justify is the alignment of the text. It can be left, right or centered.

Color Mode/Mode - selects the secondary color mode of the gauge.

Normal Mode - No secondary color is used.

Alarm Mode - If the gauge is in Alarm mode, the color of the gauge will change to the Alarm Color when the Alarm Input is equal to 1.

Static Image or Image Selector



Design
Name Image: cheeseburger_1.png

Layout
Left 280
Top 45

Data
Graphic/Input cheeseburger_1.png

Preview
Input Value 0

This gauge type is used to display either static images or changeable images that vary based on a channel value (like warning icons).

Design/Name is the name and file name of the image

Layout/Left is the horizontal (X) location of the left side of the gauge in pixels
Layout/Top is the vertical (Y) location of the top of the gauge in pixels

Data/Graphic/Input is used to select the graphic file. If the file is a Graphic Selector, the *Preview/Input Value* box may be used to simulate the behavior in the setup file. See the [Selectors](#) section for more detail.

Vertical Triangular Bar Graph

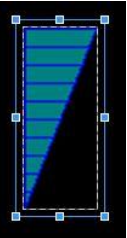

Design
Name VT Bar

Layout
Left 99
Top 93
Width 40
Height 100

Appearance
Line Blue
Background Teal
Fill Aqua
 Separators Between Bars

Data
Input
Start 0
End 10
Segment Size 1

This gauge type is used to display bar graph based on a channel value.

Design/Name is the name of the gauge.

Layout/Left is the horizontal (X) location of the left side of the gauge in pixels
Layout/Top is the vertical (Y) location of the top of the gauge in pixels
Layout/Width is the width of the gauge in pixels
Layout/Height is the height of the gauge in pixels

Appearance/Line is the color of the lines on the gauge
Appearance/Background is the color of the background sections of the gauge when it is in its base configuration
Appearance/Fill is the color of the filled or active sections of the gauge
Appearance/Separators Between Bars draws separating lines between bars

Data/Input defines the input channel to display with this gauge.
Data/Start defines the minimum display value for the gauge.
Data/End defines the maximum display value for the gauge.
Data/Segment Size is the numeric value represented by each individual segment.

Horizontal Triangular Bar Graph

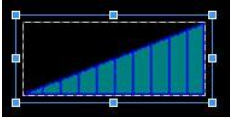

Design

Name HT Bar

Layout

Left 230

Top 132

Width 100

Height 40

Appearance

Line ■ Blue

Background ■ Teal

Fill ■ Aqua

Separators Between Bars

Data

Input

Start 0

End 10

Segment Size 1

This gauge type is used to display bar graph based on a channel value.

Design/Name is the name of the gauge.

Layout/Left is the horizontal (X) location of the left side of the gauge in pixels

Layout/Top is the vertical (Y) location of the top of the gauge in pixels

Layout/Width is the width of the gauge in pixels

Layout/Height is the height of the gauge in pixels

Appearance/Line is the color of the lines on the gauge

Appearance/Background is the color of the background sections of the gauge when it is in its base configuration

Appearance/Fill is the color of the filled or active sections of the gauge

Appearance/Separators Between Bars draws separating lines between bars

Data/Input defines the input channel to display with this gauge.

Data/Start defines the minimum display value for the gauge.

Data/End defines the maximum display value for the gauge.

Data/Segment Size is the numeric value represented by each individual segment.

Vertical Square Bar Graph

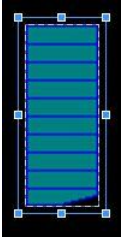

Design

Name VS Bar

Layout

Left 392

Top 132

Width 40

Height 100

Appearance

Line ■ Blue

Background ■ Teal

Fill ■ Aqua

Fill From Center

Single Line Mode

Separators Between Bars

Data

Input

Start 0

End 10

Segment Size 1

This gauge type is used to display bar graph based on a channel value.

Design/Name is the name of the gauge.

Layout/Left is the horizontal (X) location of the left side of the gauge in pixels

Layout/Top is the vertical (Y) location of the top of the gauge in pixels

Layout/Width is the width of the gauge in pixels

Layout/Height is the height of the gauge in pixels

Appearance/Line is the color of the lines on the gauge

Appearance/Background is the color of the background sections of the gauge when it is in its base configuration

Appearance/Fill is the color of the filled or active sections of the gauge

Appearance/Fill From Center fills the bar from the center

Appearance/Single Line Mode if on, the current channel value will be represented by a single moving line instead of filling the bar.

Appearance/Separators Between Bars draws separating lines between bars

Data/Input defines the input channel to display with this gauge.

Data/Start defines the minimum display value for the gauge.

Data/End defines the maximum display value for the gauge.

Data/Segment Size is the numeric value represented by each individual segment.

Horizontal Square Bar Graph

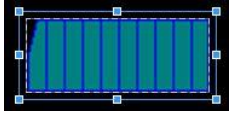

Design

Name **HS Bar**

Layout

Left

Top

Width

Height

Appearance

Line ■ Blue

Background ■ Teal

Fill ■ Aqua

Fill From Center

Single Line Mode

Separators Between Bars

Data

Input

Start

End

Segment Size

This gauge type is used to display bar graph based on a channel value.

Design/Name is the name of the gauge.

Layout/Left is the horizontal (X) location of the left side of the gauge in pixels
Layout/Top is the vertical (Y) location of the top of the gauge in pixels
Layout/Width is the width of the gauge in pixels
Layout/Height is the height of the gauge in pixels

Appearance/Line is the color of the lines on the gauge
Appearance/Background is the color of the background sections of the gauge when it is in its base configuration
Appearance/Fill is the color of the filled or active sections of the gauge
Appearance/Fill From Center fills the bar from the center
Appearance/Single Line Mode if on, the current channel value will be represented by a single moving line instead of filling the bar.
Appearance/Separators Between Bars draws separating lines between bars

Data/Input defines the input channel to display with this gauge.
Data/Start defines the minimum display value for the gauge.
Data/End defines the maximum display value for the gauge.
Data/Segment Size is the numeric value represented by each individual segment.

Fixed Shape Display

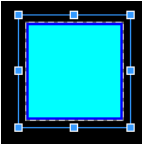

Design

Name **Shape: Rectangle**

Layout

Left

Top

Width

Height

Appearance

Line ■ Blue

Fill ■ Aqua

Shape Rectangle

Thickness Thick

This gauge type is used to display fixed shape, either rectangular or elliptical.

Design/Name is the name of the gauge.

Layout/Left is the horizontal (X) location of the left side of the gauge in pixels
Layout/Top is the vertical (Y) location of the top of the gauge in pixels
Layout/Width is the width of the gauge in pixels
Layout/Height is the height of the gauge in pixels

Appearance/Line is the color of the lines on the gauge
Appearance/Fill is the color of the filled or active sections of the gauge
Appearance/Shape Type of shape to draw, either a Rectangle or an Ellipse. The shape will fill the entire Gauge item so making the height and width the same will yield a Square or a Circle. Different sizes for each will yield a Rectangle or an Ellipse.
Appearance/Thickness is the border thickness style.

X-Y Cross Hair Gauge

Design	
Name	Cross Hair
Input X	<input type="text"/>
Input Y	<input type="text"/>
Input Value X	50
Input Value Y	50
Layout	
Left	575
Top	102
Width	40
Height	40
Appearance	
Line	<input type="color" value="Blue"/>
Background Image	<input type="text"/>
Transparent	<input checked="" type="checkbox"/> Fuchsia
	<input type="checkbox"/> Transparent
Cursor	
Size	5
Shape	Square Block
Thickness	2
Data	
Minimum X	0
Maximum X	100
Minimum Y	0
Maximum Y	100



This gauge type is used to display a "live" cursor over a fixed background image.

Design/Name is the name of the gauge.

Design/Input X is the channel to use for the X-axis

Design/Input Y is the channel to use for the Y-axis

Design/Input Value X is a preview value to be used for screen design and setup

Design/Input Value Y is a preview value to be used for screen design and setup

Layout/Left is the horizontal (X) location of the left side of the gauge in pixels

Layout/Top is the vertical (Y) location of the top of the gauge in pixels

Layout/Width is the width of the gauge in pixels

Layout/Height is the height of the gauge in pixels

Appearance/Line is the color of the lines of the gauge

Appearance/Background Image is the optional background image to display

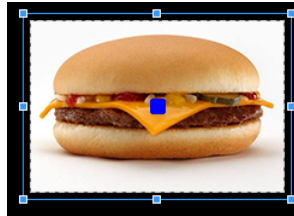

Appearance/Transparent is the transparency mask color. Select check box to enable.

Cursor/Size is the size of the cursor in pixels

Cursor/Shape is the shape of the cursor

Cursor/Thickness is the thickness of the cursor lines, in pixels

Data/Minimum X is the minimum value for the X-axis

Data/Maximum X is the maximum value for the X-axis

Data/Minimum Y is the minimum value for the Y-axis

Data/Maximum Y is the maximum value for the Y-axis

Graph/Strip Chart

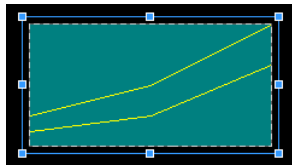

Design	
Name	Graph
Layout	
Left	280
Top	330
Width	200
Height	100
Appearance	
Background	Teal
Data	
Time Base	60
Line Count	2
Line 1	
Input	
Minimum	0
Maximum	100
Color	Yellow
Line 2	
Input	
Minimum	0
Maximum	100
Color	Yellow

This gauge type is used to display multiple live channel values in a scrolling strip chart format.

Design/Name is the name of the gauge.

Layout/Left is the horizontal (X) location of the left side of the gauge in pixels

Layout/Top is the vertical (Y) location of the top of the gauge in pixels

Layout/Width is the width of the gauge in pixels

Layout/Height is the height of the gauge in pixels

Appearance/Background is the color of the background sections of the graph when in its base configuration

Data/Time Base is the time scale of the graph in seconds. It will scroll and keep this amount of time in the window.

Data/Line Count is the number of individual channels to display on the graph

LineX/Input is the input channel for the given line trace

LineX/Minimum is the minimum scale value of the graph

LineX/Maximum is the maximum scale value of the graph

LineX/Color is the color of the given line trace

Circular Tachometer



Design

Name **Round Tacho**

Layout

Left

Top

Width

Height

Appearance

Line

Background

Fill

Label Color

Label Font

Data

Input

Start

End

Segment Size

Format

Label Frequency

Label Divisor

Preview

Input Value

This gauge type is used to display a simplistic circular gauge. In most cases, a significantly more appealing needle gauge can be created by using the [Floating Needle](#) gauge type.

Design/Name is the name of the gauge.

Layout/Left is the horizontal (X) location of the left side of the gauge in pixels

Layout/Top is the vertical (Y) location of the top of the gauge in pixels

Layout/Width is the width of the gauge in pixels

Layout/Height is the height of the gauge in pixels

Appearance/Line is the color of the lines on the gauge

Appearance/Background is the color of the background sections of the gauge when it is in its base configuration

Appearance/Fill is the color of the filled or active sections of the gauge

Appearance/Label Color is the color of the labels on the gauge

Appearance/Label Font is the font used for labels

Data/Input defines the input channel to display with this gauge.

Data/Start defines the minimum display value for the gauge.

Data/End defines the maximum display value for the gauge.

Data/Segment Size is the numeric value represented by each individual segment.

Data/Format specifies the numeric formatting of the displayed value.

Data/Label Frequency is the frequency at which labels are drawn.

Data/Label Divisor - the label values will be the channel value divided by this number.

Preview/Input Value is the value to display on the gauge during setup.

Limiter Light Gauge

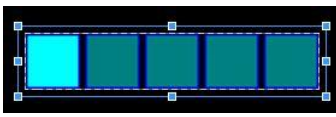

Design
Name: Limiter

Layout
Left: 258
Top: 280
Height: 30

Appearance
Line: Blue
Background: Teal
Fill: Aqua
Light Count: 5
 Circular Lights

Data
Input:
Start: 0
Increment: 5

Preview
Input Value: 0

This gauge type is used to create a series of incrementally illuminated warning lights.

Design/Name is the name of the gauge.

Layout/Left is the horizontal (X) location of the left side of the gauge in pixels

Layout/Top is the vertical (Y) location of the top of the gauge in pixels

Layout/Height is the height of the gauge in pixels

Appearance/Line is the color of the lines on the gauge

Appearance/Background is the color of the background sections of the gauge when it is in its base configuration

Appearance/Fill is the color of the filled or active sections of the gauge

Appearance/Light Count is the number of gauge lights

Appearance/Circular Lights draws circular lights instead of square

Data/Input defines the input channel to display with this gauge.

Data/Start defines the minimum display value for the gauge.

Data/Increment is the increment value for each light limit.

Preview/Input Value is the value to display on the gauge during setup.

Value Formatting

Many gauges can use a *Label Format* property in order to control how values are displayed. The following table shows the standard formatting characters that can be used.

Character	Description	Notes
X or x	Display in hexadecimal	Must be first character in format
B or b	Display in binary	Must be first character in format
-	Force leading sign character	e.g. +5.3 is displayed instead of 5.3
#	Indicates an optional digit	e.g. ### gives 93
9	Indicates a required digit	e.g. 999 gives 093
5	Indicates rounding to the nearest 5	e.g. ##5# gives 2450 instead of 2448
0	Indicates rounding to the nearest 10	e.g. ##0# gives 2400 instead of 2448
.	Indicates position of decimal place	

Gauges using time outputs use a different set of format texts:

- H - Displays the hours in 24 hour format.
- h - Displays the hours in 12 hour format.
- m - Displays the minutes.
- s - Displays the seconds.
- f - Displays tenths of seconds.
- ff - Displays hundredths of seconds.
- fff - Displays thousandths of seconds (only works for lap time via CAN).
- y - Displays the date in dd-mm-yy format
- z - Displays the date with text for the month, eg 01 Jan 09

Thus, the following formats would display the time in the following manner:

- Hms - 24:00:00

- hmsf - 12:00:00.0
- hmsff - 12:00:00.00
- y - 01-01-09
- hmsz - 12:00:00 01 Jan 09

System information can be shown by adding a value gauge to the screen and setting the **Label Format** property as follows:

- vV - Shows the version of the color display firmware.
- vs - Shows the serial number of the display.
- vu - Shows the usage (on time) of the display in hours.
- vr - Shows the reset counter - the number of power on events since the last setup upload.
- vc - Shows the filename of the setup file used to program the display (up to 24 characters).

Hardware Reference

Hardware Features

- Full color CAN display and logger (logging versions only)
- Completely user definable CAN receive
- Dual CAN bus
- Full graphics display with up to 6 different pages
- Unit ships with 6 display pages for the AEMNet data stream as the default setup
- Completely user definable graphical layouts
- Stand-alone PC program to create and customize layouts
- Water resistant enclosure with rear facing DTM 12 pin connector
- 7" or 5" (diag) 800x480 super bright color display
- Night mode input
- 7 shift lights and 2 alarm LEDs
- 200mb onboard logging memory (logging versions only)
- Up to 1000hz sample rate (logging versions only)
- Onboard 5Hz GPS/GLONASS receiver (GPS versions only)
- Log data downloaded and viewed with AEMdata via USB port with sealed bulkhead extension cable (logging versions only)
- Beacon input

Mechanical & Mounting

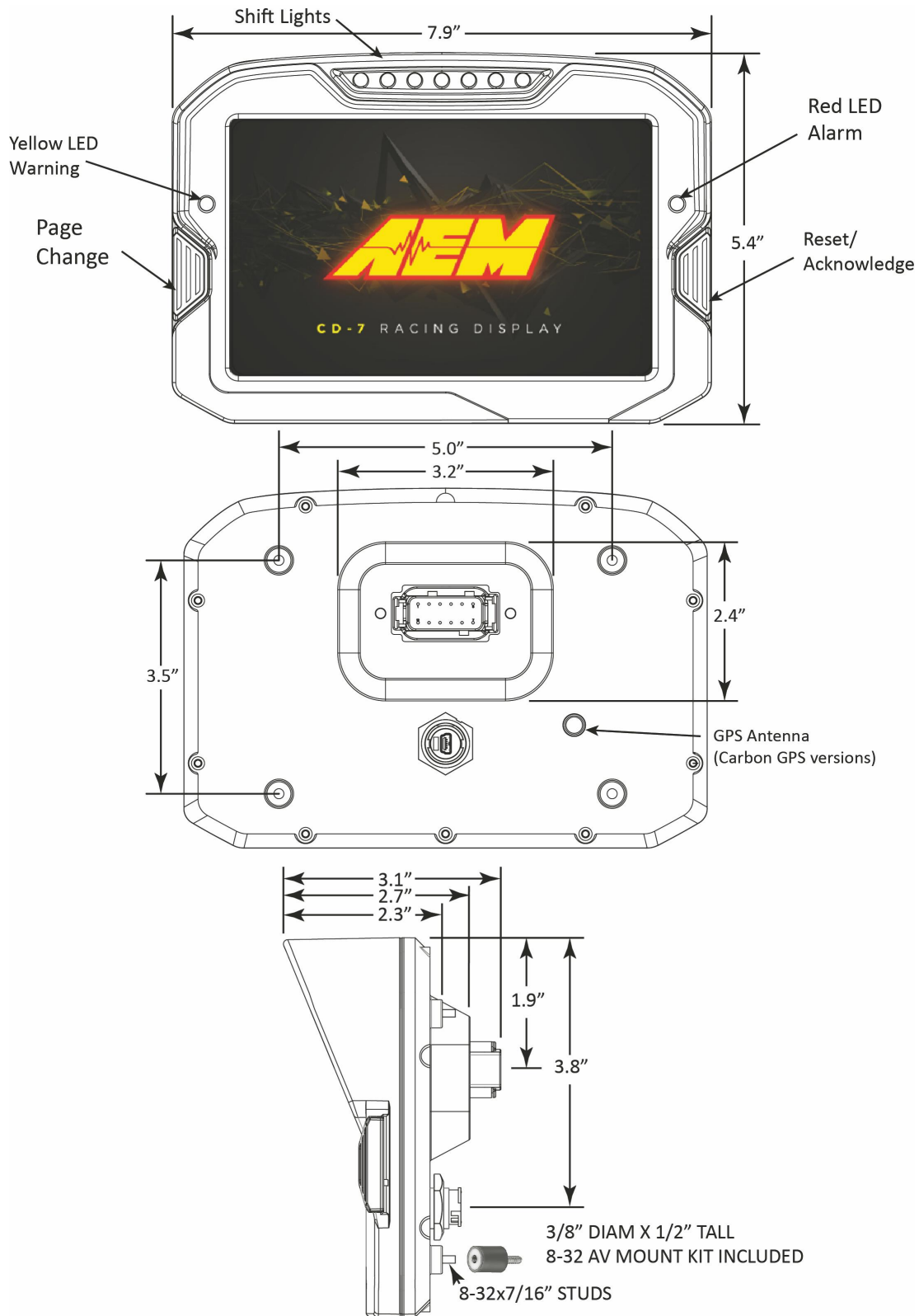

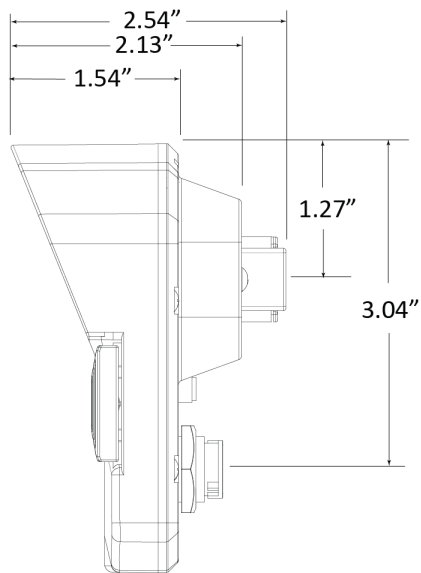
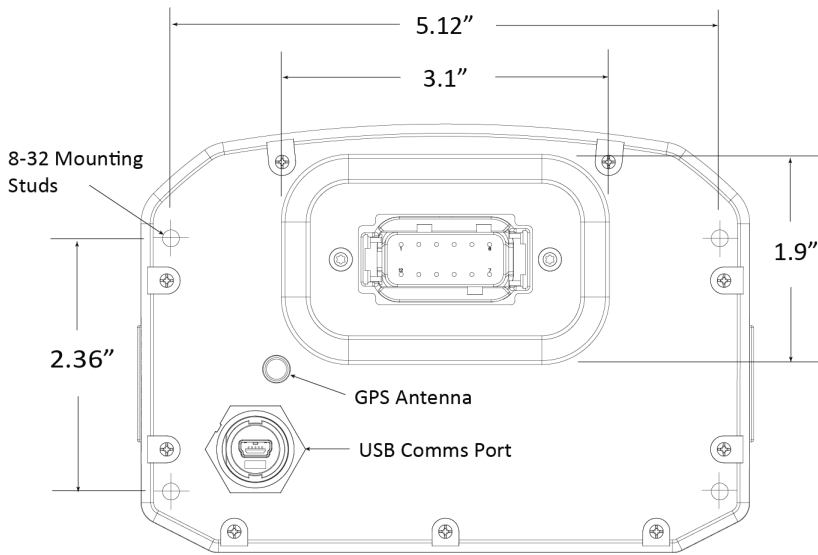
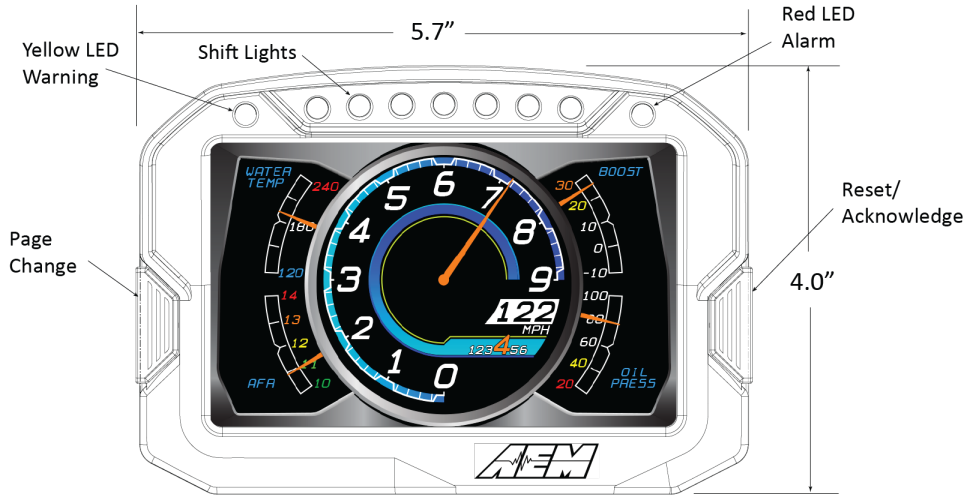

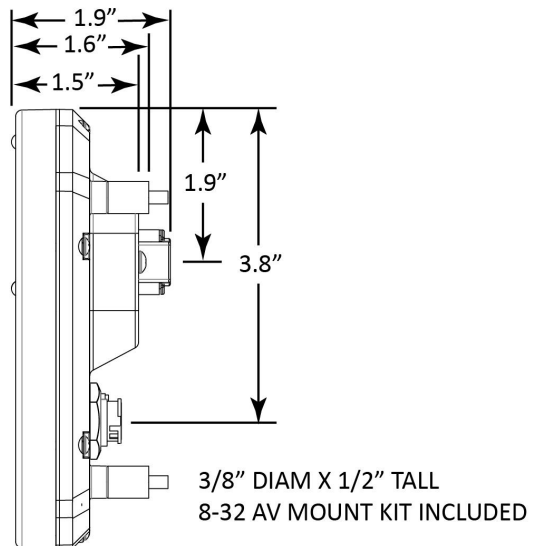
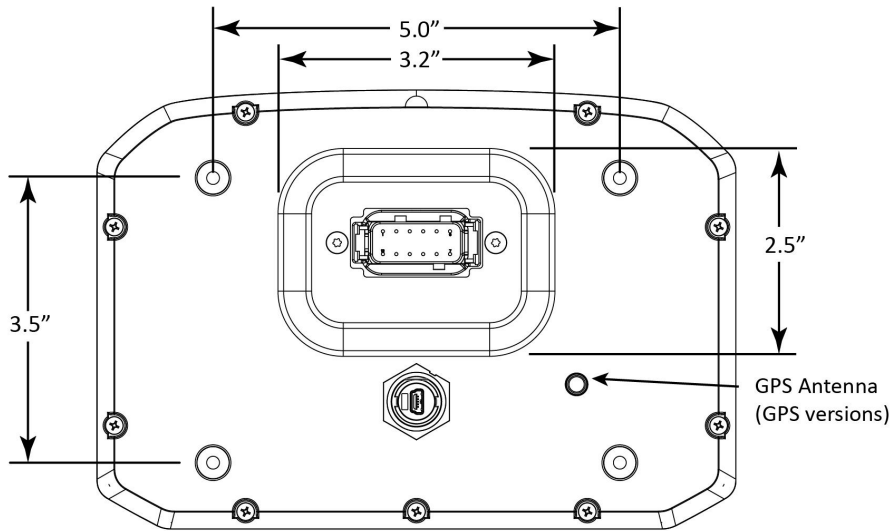
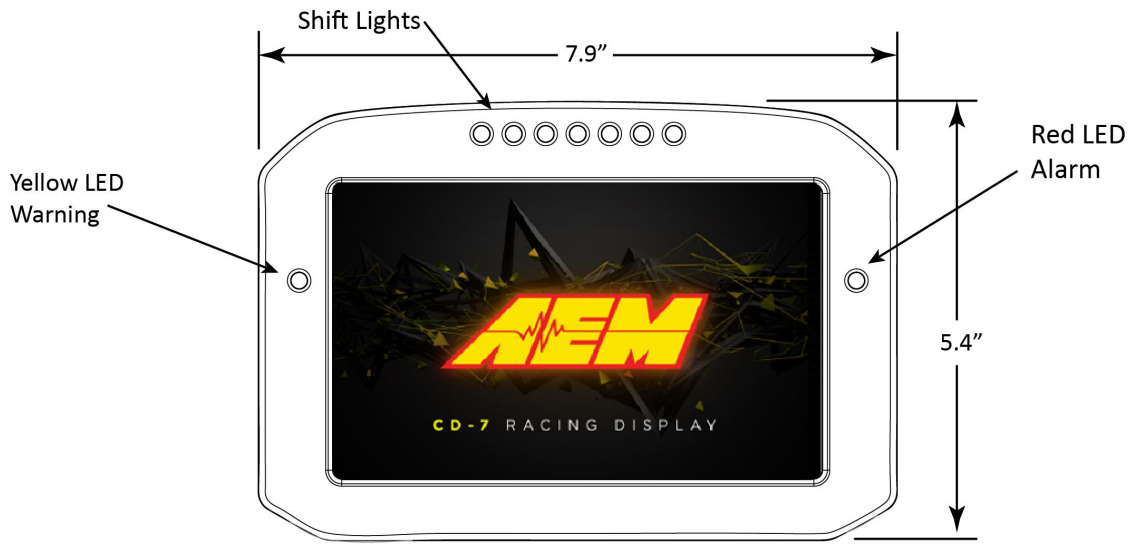

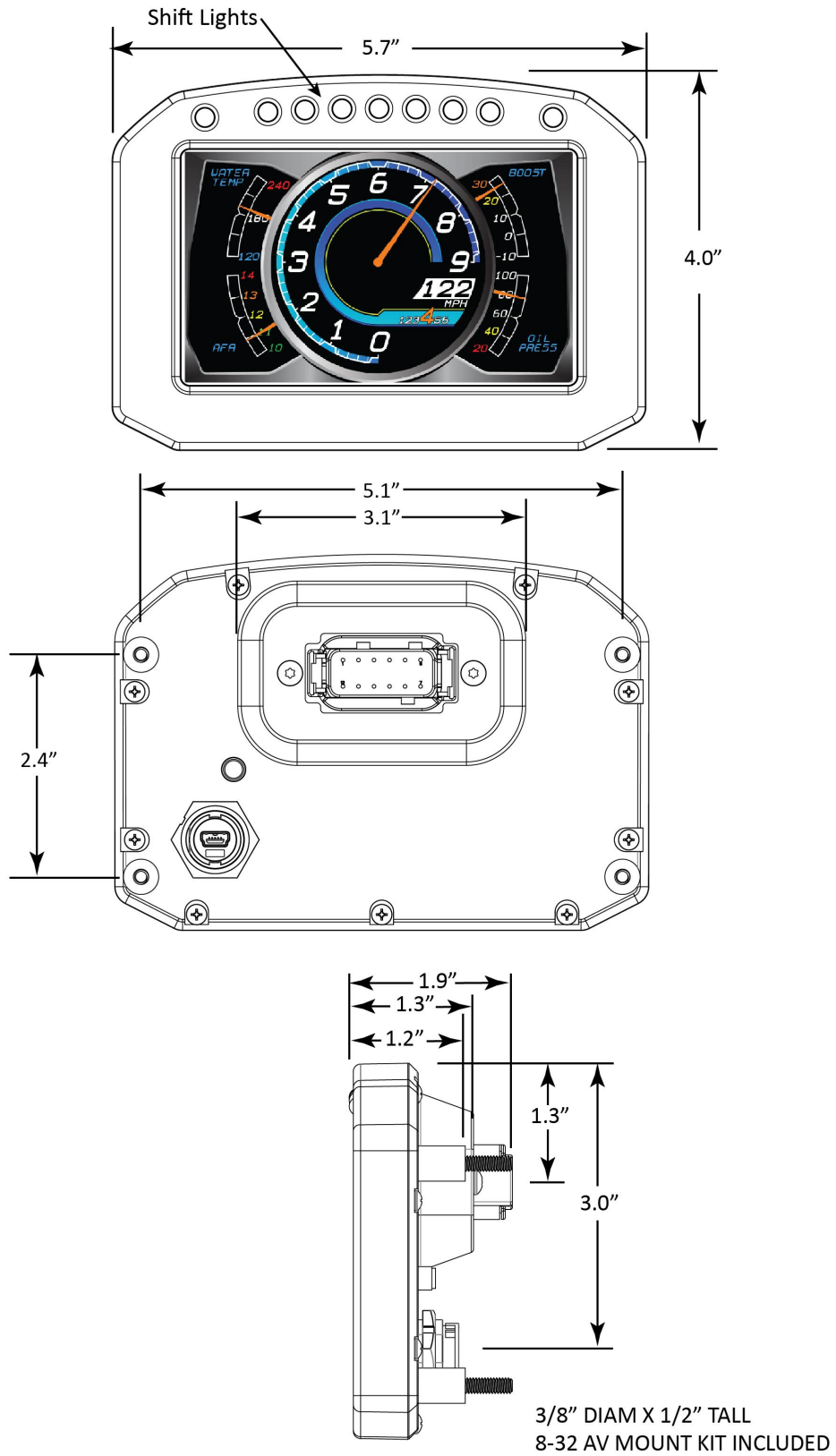

Drill Template



Electrical & Wiring

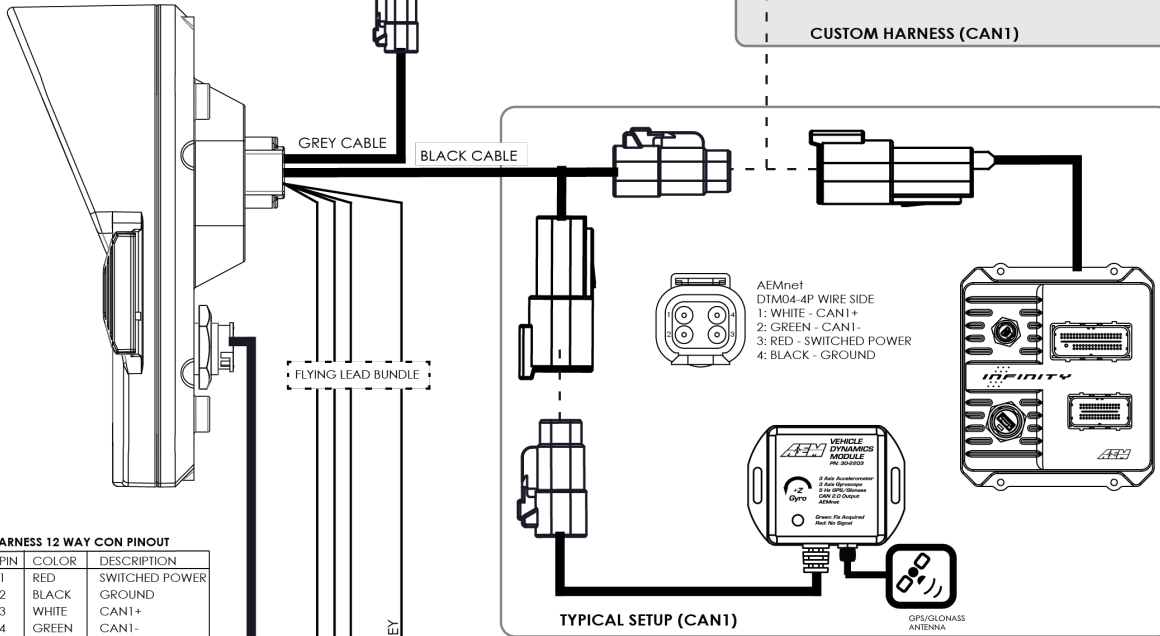
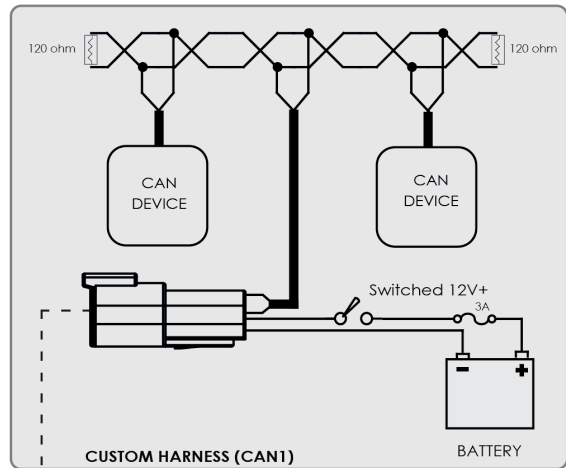
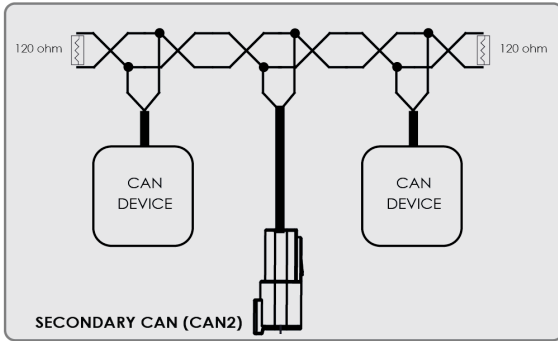

HARNESS 12 WAY CON PINOUT

PIN	COLOR	DESCRIPTION
1	RED	SWITCHED POWER
2	BLACK	GROUND
3	WHITE	CAN1+
4	GREEN	CAN1-
5	GREY	CAN2+
6	BLACK	CAN2-
7	BLUE	PAGE UP
8	YELLOW	RESET/ACK
9	GREY	NIGHT MODE
10	VIOLET	BEACON
11	NA	SPARE1
12	NA	SPARE2

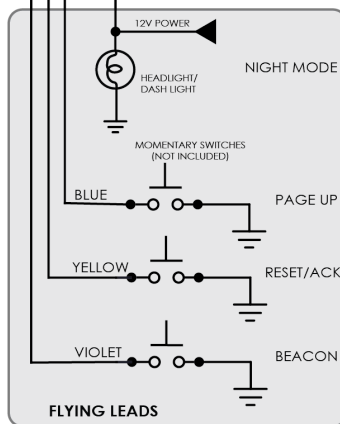

TYPICAL SETUP (CAN1)

Plug and Play setup for users with existing AEMNet devices and most AEM supplied harnesses. No additional wiring necessary. Power is supplied through the AEMNet connector. AEM VDM P/N 30-2203 recommended for GPS lap timing features. Select *Port 1* in Setup Editor CAN Receive tab.

FLYING LEADS

Optional flying lead connections. External PAGE UP (left dash button), RESET/ACK (right dash button) and BEACON inputs require a user supplied momentary switch to ground. The NIGHT MODE input can be used to control the dash display brightness. Connect to existing headlight or dash lamp circuit. *Requires a 12 volt input.*

SECONDARY CAN (CAN2)

Select *Port 2* in Setup Editor CAN Receive tab. Terminating resistor requirement depends on the network configuration.

CUSTOM HARNESS (CAN1)

Can be used for third party CAN devices. Switched power and ground inputs are required if not using an AEM supplied harness that includes an AEMNet connector. Terminating resistor requirement depends on network configuration. Select *Port 1* in Setup Editor CAN Receive tab.

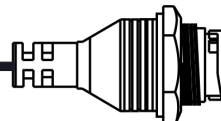

Sealed bulkhead communications cable included with CD-7L kits only.



Drawing: BASIC HARNESS WIRING

PRODUCT: AEM CD-7/CD-7L

Date: 4/3/2017

Rev: B

Engineer: Armish

AEMNet Network Wiring

AEMNet Network Wiring

Refer to the following guidelines when wiring AEMnet (CAN) devices.

- Twisted wire is required with >1 twist per inch.
- AEMnet buses must be properly terminated. Termination resistors are 120 Ohms each, two total, located at the physical ends of the bus wires.

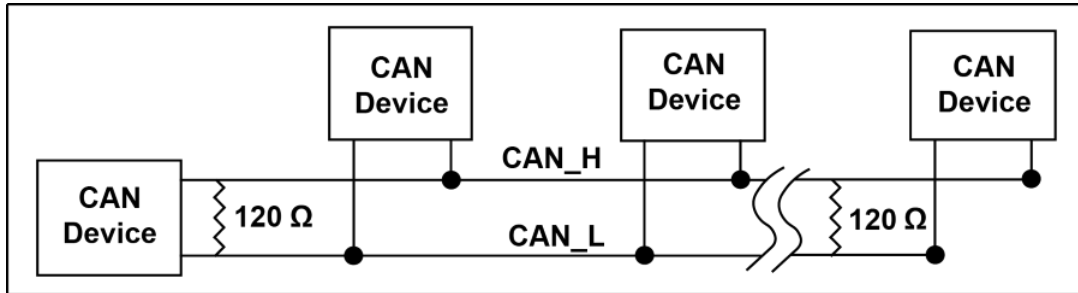

Termination Resistors

Device	Configuration
30-2226, 6ch CAN Sensor Module	No resistor
30-2224, CAN EGT	No resistor
30-2212, 22ch CAN Sensor Module	Jumper selectable
30-2340, 4ch UEGO	Jumper selectable, enabled by default
30-560X & 30-570X CAN Dash	Software selectable, enabled by default
30-710X, Infinity	Hardware enabled by default on CAN A (AEMNet)
30-2500, AQ1	Included, non-configurable

The following Deutsch DTM 4-pin termination plugs are available

PN	Description
35-3440-F	AEMNet Termination Plug, Female
35-3440-M	AEMNet Termination Plug, Male

Optional OBDII & Power Cable Kits

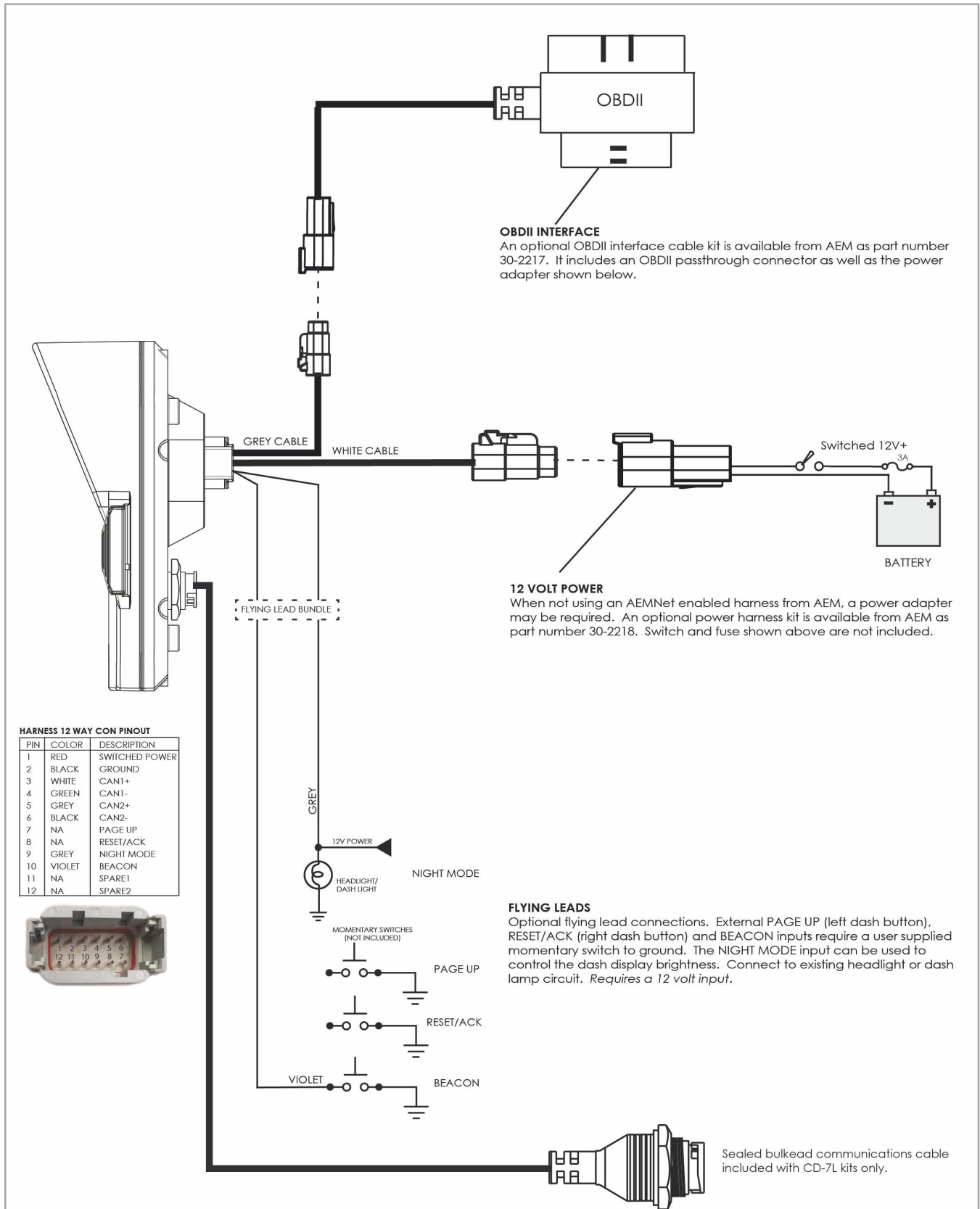

Drawing: OPTIONAL OBDII AND POWER WIRING

PRODUCT: AEM CD-7/CD-7L

Date: 11/15/2017

Rev: B

Engineer: Armish

OBDII PID Scan

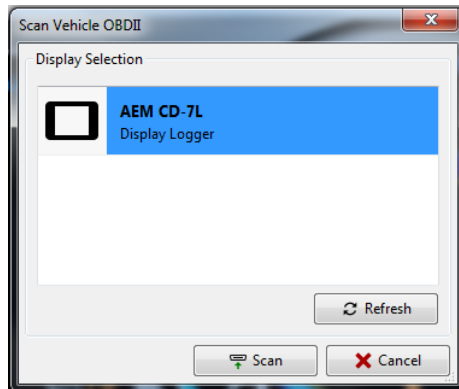

1. Launch AEM DashDesign and go to Tools | Scan Vehicle OBDII...
2. Click Scan

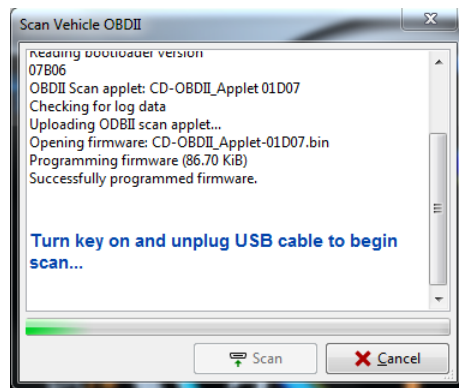

1. Turn ignition key on
2. Unplug the USB cable from the PC to begin the scan.

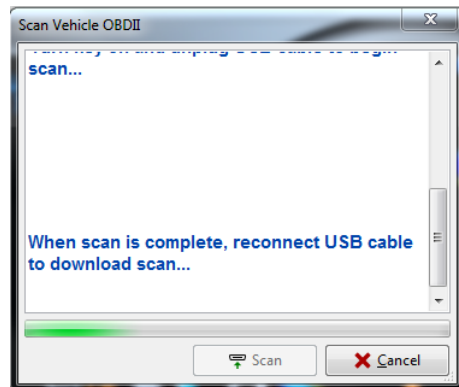

1. The scan begins automatically.
2. Wait for the scan to complete.
3. Reconnect the USB cable to your PC.

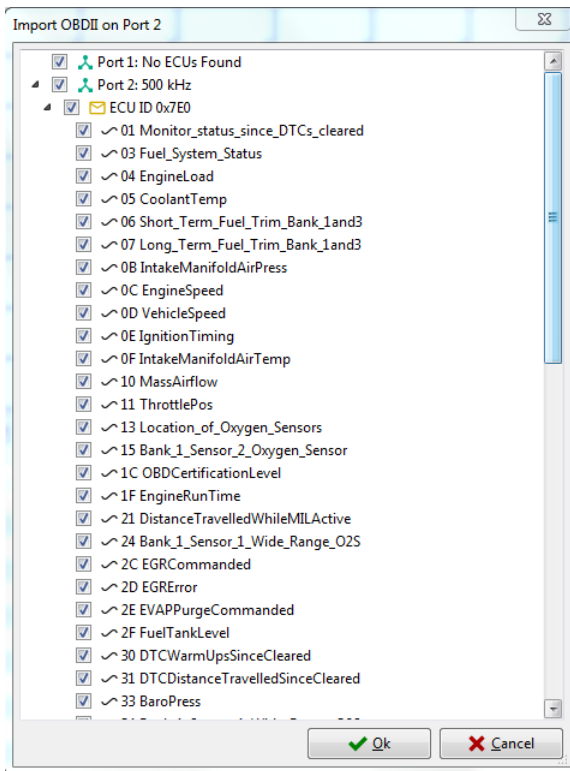

1. Select desired channels from the list of available PIDs

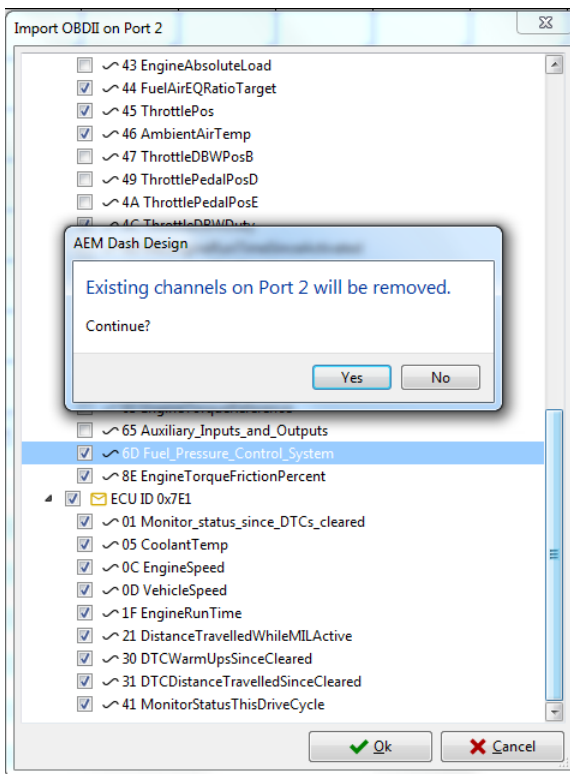

1. This is an information message informing you that all the existing channels on Port 2 (which was used in this example) will be removed. This is normal.
2. Click Yes

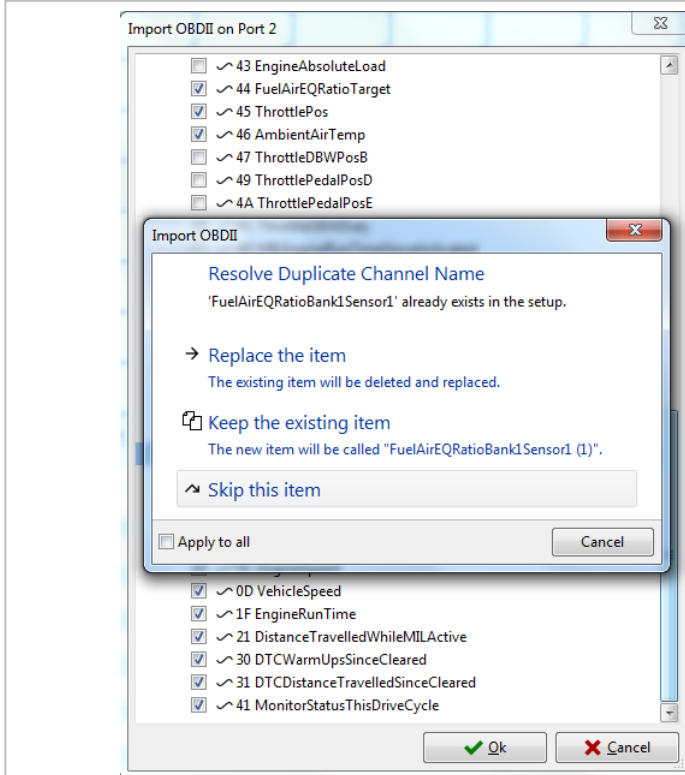

1. If there are any duplicate named channels existing in the setup file, the system will notify you. Normally you want to replace them.
2. Click Apply to all.
3. Click Replace the item.

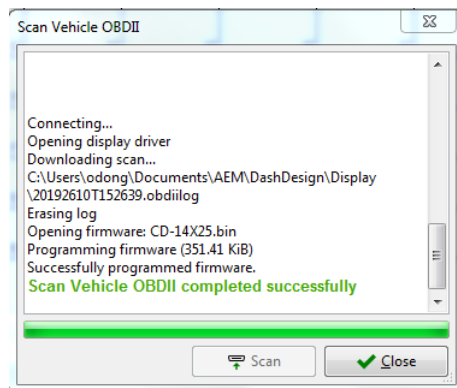

1. Once the process is completed, click Close.

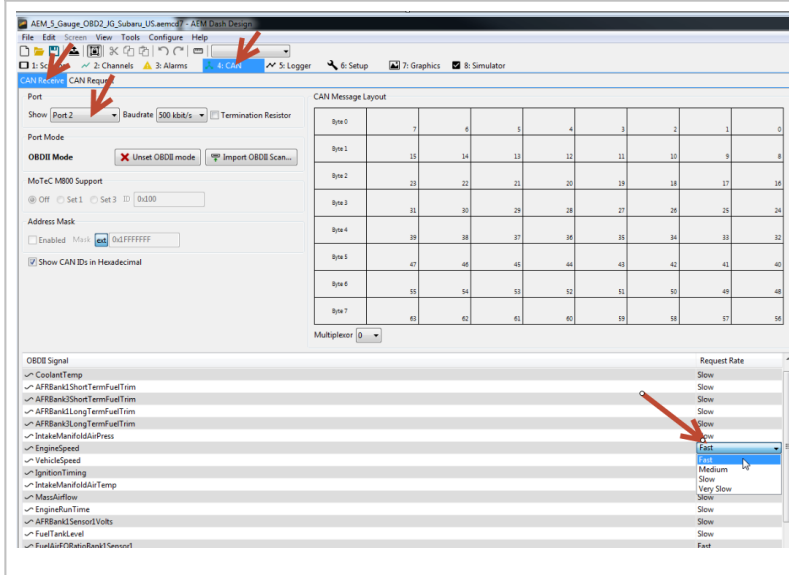

1. Go to the CAN tab
2. Select the CAN Receive sub tab
3. Show Port 2
4. Select your desired request rate for each OBDII channel.

Note, the possible request rates listed are relative rankings and correlate to how frequently the selected channel will be requested relative to the fastest channel being requested. The actual update rate is completely driven by the ECU, not the dash, and is somewhat speed limited by the ECU. The best way to get good data is to make sure you give priority to the fast changing data and relegate the unchanging data to the slowest request rate. Things like Coolant Temp and long term fuel trims may remain static for multiple seconds so only updating them slowly will still give very good data and will yield space for things like engine ROM to be updated quickly.

Also, note that there is no "Zero" or "Off" request rate, this is because the system only requests OBDII channels that are actively being displayed on the

current screen, used in an alarm or warning, or being logged (logging displays only). Any OBDII channel that is not being actively used by the dash is not being requested from the ECU, regardless of the request rate setting.

Uploading a Setup File

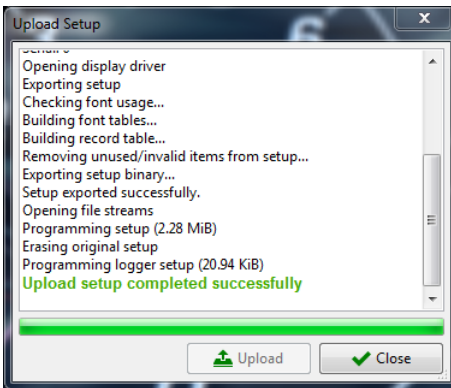
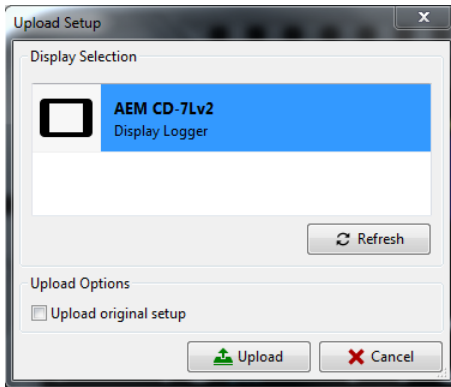

1. Connect your PC to the dash using the USB cable.
2. Make sure the dash is powered up.
3. In the DashDesign software, go to File | Open...
4. Navigate to the library of pre-configured setup files for the Infinity. They are installed at the following location. \Documents\AEM\DashDesign\Setups\.
5. Choose your file and click Open.
6. Go to File | Upload to display. DashDesign will present a selection window showing the currently connected dash.
7. Click Upload.
8. The dialog will display progress.
9. Click close.

Upload Options / Upload original setup - stores the original setup in the display for later downloading. Makes the complete setup file available for retrieval from the display itself. If you do not select this option, you can not download the setup from the display at a later time.

Downloading a Setup File

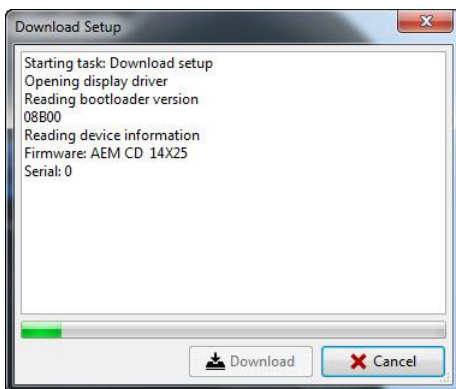
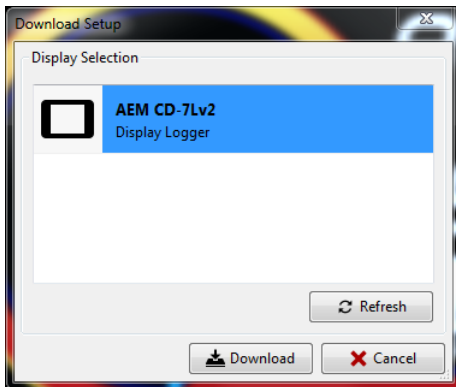

If the Upload original setup option was selected the last time a setup was uploaded, it will be available for download from the display. See [Uploading a Setup File](#) for more detail.

1. Connect your PC to the dash using the USB cable.
2. Make sure the dash is powered up.
3. Go to File | Download From Display.
2. Click Download.
3. The download dialog will display progress.
4. Save the downloaded file via the file save dialog.

Program Clock

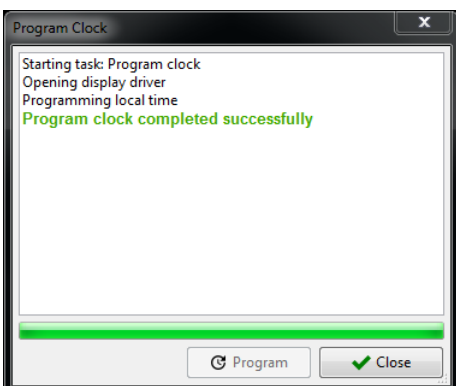
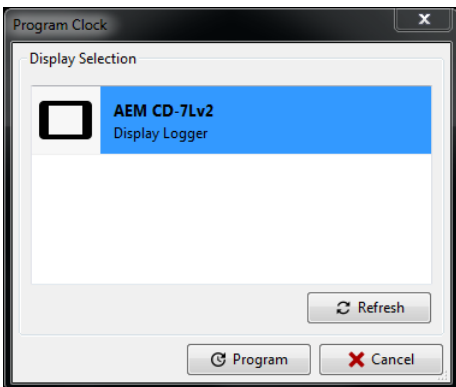

1. Connect your PC to the dash using the USB cable.
2. Make sure the dash is powered up.
3. Select Tools | Program Clock...
4. Click Program
5. A dialog will be displayed indicating the command was completed successfully.
6. Click Close.

Updating the Firmware Version

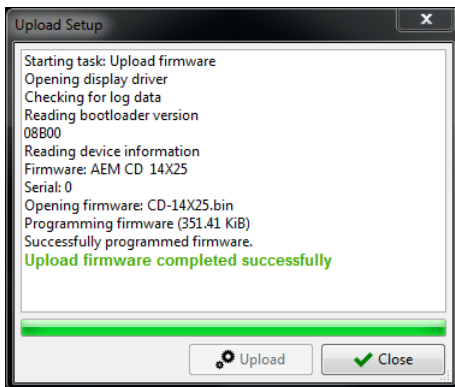
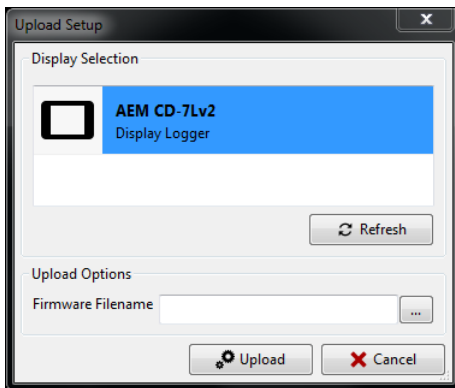

1. Connect your PC to the dash using the USB cable.
2. Make sure the dash is powered up.
3. In DashDesign, go to Tools | Upload Upload Firmware...
4. Click on the (...) button and select a firmware file. The firmware files are located at \Documents\AEM\DashDesign\Firmware with the format CD-14x25.bin where x25 is an example version.
5. Click Upload.
6. The upload dialog will display progress.
7. Click Close.

Downloading Log Files

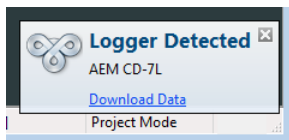

To download log files from the CD dash:

1. launch AEMdata
2. Power the dash on and connect the comms cable to bulkhead cable USB port.
3. A Logger Detected message will be shown once the AEMdata software connects with the dash.
4. In the message, click on Download Data, select the files to be saved and click Ok.
5. Select a save location, name the file and click on Save.