

Instruction Manual



30-71XX Infinity User Guide



STOP!

THIS PRODUCT HAS LEGAL RESTRICTIONS.
READ THIS BEFORE INSTALLING/USING!

THIS PRODUCT MAY BE USED SOLELY ON VEHICLES USED IN SANCTIONED COMPETITION WHICH MAY NEVER BE USED UPON A PUBLIC ROAD OR HIGHWAY, UNLESS PERMITTED BY SPECIFIC REGULATORY EXEMPTION. (VISIT THE "EMISSIONS" PAGE AT [HTTP://WWW.SEMASAN.COM/EMISSIONS](http://www.semasan.com/emissions) FOR STATE BY STATE DETAILS.)

IT IS THE RESPONSIBILITY OF THE INSTALLER AND/OR USER OF THIS PRODUCT TO ENSURE THAT IT IS USED IN COMPLIANCE WITH ALL APPLICABLE LAWS AND REGULATIONS. IF THIS PRODUCT WAS PURCHASED IN ERROR, DO NOT INSTALL AND/OR USE IT. THE PURCHASER MUST ARRANGE TO RETURN THE PRODUCT FOR A FULL REFUND.

THIS POLICY ONLY APPLIES TO INSTALLERS AND/OR USERS WHO ARE LOCATED IN THE UNITED STATES; HOWEVER CUSTOMERS WHO RESIDE IN OTHER COUNTRIES SHOULD ACT IN ACCORDANCE WITH THEIR LOCAL LAWS AND REGULATIONS.

WARNING: This installation is not for the tuning novice! Use this system with **EXTREME** caution! The AEM Infinity Programmable EMS allows for total flexibility in engine tuning. Misuse or improper tuning of this product can destroy your engine! If you are not well versed in engine dynamics and the tuning of engine management systems **DO NOT** attempt the installation. Refer the installation to an AEM-trained tuning shop or call 800-423-0046 for technical assistance.

NOTE: All supplied AEM calibrations, Wizards and other tuning information are offered as potential starting points only. **IT IS THE RESPONSIBILITY OF THE ENGINE TUNER TO ULTIMATELY CONFIRM IF THE CALIBRATION IS SAFE FOR ITS INTENDED USE.** AEM holds no responsibility for any engine damage that results from the misuse or mistuning of this product!

AEM Performance Electronics
AEM Performance Electronics, 2205 126th Street Unit A, Hawthorne, CA 90250
Phone: (310) 484-2322 Fax: (310) 484-0152
<http://www.aemelectronics.com>
Instruction Part Number: 10-7100_Full
Document Build 12/14/2015

Table of Contents

Introduction

12 Month Limited Warranty.....	1
AEM Infinity.....	1
Background.....	2
Revision History Log.....	2

Software

Software Installation.....	3
FAQ.....	4
Flash Memory Functions.....	4
Getting Started.....	5
File Menu.....	5
Connection Menu.....	10
Target Menu.....	11
Layout Menu.....	13
Default Layouts.....	16
Log Menu.....	16
Wizards Menu.....	20
Help Menu.....	20
Connection Status.....	20
Control Windows.....	21
Virtual and Conversion Channels.....	35
Plot Data and Control.....	39
Windows Hot Keys.....	40
Infinity Hot Keys - Quick Reference.....	41
Infinity Hot Keys - Configuration.....	42

Hardware

Serial Number.....	50
Account Registration	50
aeminfinity.com file descriptions.....	58
Firmware Update Window Layout.....	59
Firmware Update.....	61
Firmware Update Troubleshooting.....	68
Infinity Hardware Specifications	72
ECU Installation.....	73
USB & Logging Connectors.....	74
ECU Installation Dimensions Infinity-8/10/12.....	75

ECU Installation Dimensions Infinity-6/8h..... 76

Tuning Guide

Background..... 77

Basic Tuning..... 77

 Calibration Data.....77

 Unit Preferences.....78

 Wizard Basic Setup.....79

 Wizard Design.....79

 Wizard Organization.....80

 Engine.....81

 Engine Rotary.....82

 Tuning Preferences.....84

 Cam/Crank.....85

 Mass Airflow.....86

 Injector Setup.....90

 Basic Sensor Setup.....94

 DBW Tuning.....105

 Set Throttle Range.....108

 Ignition Sync.....109

 Oil Metering Pump.....111

 Follow ECU.....112

 Modified Values.....114

 Right Click Editing.....115

 Engine Start.....116

 Idle Air Control.....118

 VE & Airflow Based Tuning.....120

 Target Lambda.....124

 Lambda Control Tuning.....126

 Fuel Trims.....129

 Ignition Tuning.....133

 Ignition Trims.....135

 DBW Idle Air Control.....137

Advanced Tuning..... 138

 Wizard Advanced Setup.....138

 Accel and Decel Fuel.....138

 Advanced Trims.....140

 Boost Control.....142

 Engine Protection.....158

 Idle - Basic.....161

 Idle – Advanced.....163

Input Function Assignments.....	170
Knock Setup.....	196
Lambda Control.....	202
Launch Antilag.....	205
Launch Timer.....	208
Nitrous N2O.....	210
Main Rev Limiter.....	213
Rev Limit 2Step.....	215
Rev Limit 3Step.....	217
Shift Cut.....	219
Shift Cut Time.....	220
Traction Control.....	222
USB Logging.....	226
VVC.....	227
Diagnostics.....	228
Output Assignments.....	230
Coils / Injectors.....	236
Injector Control.....	236
Injector Pressure.....	237
Flex Fuel Tuning.....	239
Multi-Map Tuning.....	241
Advanced Individual Cylinder Tuning.....	248
Staged Injection Tuning.....	248
DBW Custom Setup and Troubleshooting.....	249
Coil Dwell Tuning.....	252
VR PWMDuty [%] Tables.....	253
Cam/Crank Noise Cancellation Feature.....	254
CAN (AEMNet).....	256
4 Channel Wideband UEGO Controller Setup.....	266

EFI Components

Spark Plugs.....	267
Ignition Coils.....	271
Combustion Chamber.....	272
TPS (Throttle Position Sensor).....	277
MAP (Manifold Absolute Pressure).....	277
IAT (Inlet Air Temperature).....	280
CLT (Coolant Temperature).....	281
O2 (Oxygen Sensor).....	282
KNK (Knock Sensor).....	286
PPS (Pedal Position Sensor).....	286

CMP/CKP (Cam/Crank Position).....	287
IAC (Idle Air Control).....	288
FCS (Fuel Composition Sensor).....	290
Fuel System Setup	
Fuel Plumbing.....	291
Fuel Pump.....	292
Fuel Injector.....	294
Fuel Pressure Regulator.....	295
Fuel Filter.....	297
Fuel Rail.....	297
Wiring, Pinouts and Schematics	
Wiring.....	298
Wiring Conventions.....	298
Tools.....	300
Grounding.....	301
Power Requirements.....	301
General Purpose Outputs.....	302
Injectors.....	302
Ignition System.....	303
Noise.....	308
Sensors.....	308
Digital Switch Inputs.....	312
Auxiliary Connector.....	313
Idle Air Control Valve Requirements.....	313
Universal Pinout, Infinity-8/10/12.....	315
Universal Pinout, Infinity-6/8h.....	328
Connector Views Infinity-8/10/12.....	336
Connector Views Infinity-6/8h.....	336
Example System Schematics.....	336
Power Distribution, Infinity-6/8h.....	338
Power Distribution, Infinity-8/10/12.....	339
Internal UEGO, Infinity-6/8h.....	340
Internal UEGO, Infinity-8/10/12.....	341
95 BMW E36 M3, Infinity-6/8h.....	342
95 BMW E36 M3, Infinity-8/10/12.....	343
EVO VIII, Infinity-6/8h.....	344
EVO VIII, Infinity-8/10/12.....	345
EVO IX Pinout, Infinity-6/8h.....	346
EVO IX Pinout, Infinity-8/10/12.....	347
93–98 Toyota Supra 2JZGTE, Infinity-6/8h.....	348

Infinity User Guide

93–98 Toyota Supra 2JZGTE, Infinity-8/10/12.....349
Ignition System – COP 2 Wire "Dumb" Coils with Ignitor, Infinity-6/8h.....350
Ignition System – COP 2 Wire "Dumb" Coils with Ignitor, Infinity-8/10/12.....351
Ignition System – COP 3 Wire "Dumb" Coils with Ignitor, Infinity-6/8h.....352
Ignition System – COP 3 Wire "Dumb" Coils with Ignitor, Infinity-8/10/12.....353
Ignition System – COP 3 Wire "Smart" Coils, Infinity-6/8h.....354
Ignition System – COP 3 Wire "Smart" Coils, Infinity-8/10/12.....355
Ignition System – COP 4 Wire "Smart" Coils, Infinity-6/8h.....356
Ignition System – COP 4 Wire "Smart" Coils, Infinity-8/10/12.....357
Ignition System – COP 5 Wire "Smart" Coils, Infinity-6/8h.....358
Ignition System – COP 5 Wire "Smart" Coils, Infinity-8/10/12.....359
GM LS3 DBW Wiring, Infinity-6/8h.....360
GM LS3 DBW Wiring, Infinity-8/10/12.....361
Mazda RX7 FD Wiring, Infinity 6.....362

Glossary of Terms

Glossary..... 363

Introduction

12 Month Limited Warranty

Advanced Engine Management Inc. warrants to the consumer that all AEM High Performance products will be free from defects in material and workmanship for a period of twelve (12) months from date of the original purchase. Products that fail within this 12-month warranty period will be repaired or replaced at AEM's option, when determined by AEM that the product failed due to defects in material or workmanship. This warranty is limited to the repair or replacement of the AEM part. In no event shall this warranty exceed the original purchase price of the AEM part nor shall AEM be responsible for special, incidental or consequential damages or cost incurred due to the failure of this product. Warranty claims to AEM must be transportation prepaid and accompanied with dated proof of purchase. This warranty applies only to the original purchaser of product and is non-transferable. All implied warranties shall be limited in duration to the said 12-month warranty period. Improper use or installation, accident, abuse, unauthorized repairs or alterations voids this warranty. AEM disclaims any liability for consequential damages due to breach of any written or implied warranty on all products manufactured by AEM. Warranty returns will only be accepted by AEM when accompanied by a valid Return Merchandise Authorization (RMA) number. Product must be received by AEM within 30 days of the date the RMA is issued.

UEGO oxygen sensors are considered wear items and are not covered under warranty.

Please note that before AEM can issue an RMA for any electronic product, it is first necessary for the installer or end user to contact the EMS tech line at 1-800-423-0046 to discuss the problem. Most issues can be resolved over the phone. Under no circumstances should a system be returned or a RMA requested before the above process transpires.

AEM will not be responsible for electronic products that are installed incorrectly, installed in a non-approved application, misused, or tampered with.

Any AEM electronics product can be returned for repair if it is out of the warranty period. There is a minimum charge of \$50.00 for inspection and diagnosis of AEM electronic parts. Parts used in the repair of AEM electronic components will be extra. AEM will provide an estimate of repairs and receive written or electronic authorization before repairs are made to the product.

AEM Infinity

The AEM Infinity is a user-programmable Electronic Control Unit (ECU) that uses a powerful twin-CPU design. The unit features a 200Mhz 32-bit processor and a 20Mhz 16-bit aux processor with 4GB flash drive standard, expandable up to 64GB (flash drive) memory. The Infinity includes a configurable internal data logger capable of recording 100 channels at up to 1kHz of information. Every Infinity system comes with all functions installed and activated and there are no expensive options or upgrades to be performed.

The Infinity is a tool that allows the user to custom tune an engine by specific requirements. This is extremely useful and usually necessary when upgrading the engine for maximum performance, especially if installing a turbocharger, supercharger or building up a normally aspirated engine. The Infinity completely replaces the factory ECU and features unique plug and play technology, which means that each system is configured especially for the make and model of car. There is no need to modify the factory wiring harness and in most cases the vehicle may be returned to stock in a matter of minutes. The Infinity Tuner software is configured to work with the factory sensors and equipment, so that there is no need for expensive or hard to find sensors making replacement and repairs as simple as with an unmodified car.

Background

The Infinity platform is very different from previous generation AEM EMS products. The hardware (circuit board assembly) is designed around a very advanced automotive grade microcontroller (processor or “chip”). Several layers of software reside on this chip that allow for real time firmware programming without the need to write computer code. This technology has allowed AEM to develop advanced control models never before used on other AEM EMS products. We’ve listened to our customers over the years and have attempted to simplify the tuning process by employing an airflow based fuel control model eliminating many of the lookup and trim tables from previous generation ECUs. The look and feel is very different and it may take some time to adjust to the new tuning environment.

Our new tuning tool, Infinity Tuner is also a brand new product built from the ground up to interface with the new hardware. It features a modular design that allows users and developers to build completely customized templates and even design “plug in” applications that can automate many tuning tasks. Unlike previous AEM Setup Wizards in older products like AEM Pro and AEM Tuner, the Infinity Tuner Setup Wizard “plug in” is a completely stand-alone application that will evolve with Infinity Tuner. It is much more integrated with the ECU hardware and performs complex validation checks for all requested changes.

Among other things, Infinity Tuner is a powerful math processor. In addition to supporting standard global units and math functions, special features allow users to create completely custom conversion channels for table data. Virtually any function can be employed to display data in different formats or units. Math functions are also used for table edits. ANY MATH function can be used not just a list of pre-defined selections. Advanced users will really enjoy the flexibility this feature adds.

A built-in logging playback/controls synchronization feature allows tuners to view live plot data and make changes to their calibration values on the fly, knowing exactly where the ECU was accessing table data. For more detailed post processing of data, AEM offers its new analysis package, AEMdata.

Revision History Log

Version	Date	Modified Sections	Descriptions
B	4/23/13	Miscellaneous updates	
C	7/1/13	Wiring	Removed Supra specific content
D	9/30/13	Wiring	Power Distribution Schematic and Pinout updated
E	2/5/14	Many	Updated to reflect v95 revisions
F	8/25/14	Many	Updated to reflect v95b revisions
G	10/28/14	Many	Updated to reflect v96 revisions
H	4/28/15	Many	Updated to reflect v96.1 revisions

Software

Software Installation

Minimum computer requirements:

OS - Windows XP with .NET 4.0 framework installed

Ram - 2GB

Processor - 1 GHz

Free HD space - 600 Mb

Connectivity - USB 2.0

All current Infinity Tuner software installations are available for download from AEM at <http://www.aemelectronics.com/support/SoftwareDownloads>

All current firmware pakgrp files are available for download from AEM at <http://www.aeminfinity.com>. **You must download and save a valid pakgrp file before proceeding with the firmware update process.**

1. Run the setup.exe. Hit Next> and follow the instructions on each page.
2. Read and accept the terms of agreement and pick your desired location for Infinity Tuner to be installed. Hit Next> and allow the software to complete installation.
3. You may now exit the Infinity Tuner installer. You can now run Infinity Tuner.

FAQ

What are the basic sensors needed?

In order to use the Infinity to its full potential you will need the following; Intake Air Temperature Sensor, Manifold Air Pressure Sensor, Coolant Temperature and a Wide Band Air/Fuel Ratio sensor.

Why doesn't the Infinity work with (insert vehicle or engine description here)?

We have not had the opportunity to map the Cam and Crank profiles of that engine yet. If your cam and crank matches another vehicle we do have, it will work.

What do you mean by matching the cam and crank profile to another car?

The number of teeth on a crank trigger and cam trigger let the Infinity know where the engine position is exactly. Based on that the infinity will know when to spark, and inject fuel.

Will this control my Supra VVTI?

Yes.

What is the difference between an Infinity-8 and an Infinity-8h?

The 8h will control 8 high impedance injectors only, while the 8 will control either high or low impedance injectors. The Infinity 8 also has more inputs and outputs available for use. TC/DBW etc etc.

Is the Infinity Waterproof?

Yes, it is fully sealed with IP67 connectors.

Flash Memory Functions

Changes made to calibration tables are stored on the ECU in a temporary memory location and applied immediately. In other words, while tuning live, all changes take effect immediately. They are not however immediately saved to ECUs flash memory. The menu function Target – Commit modifications (Hot Key – CTRL + SHIFT + C) is used to save all current changes to the flash. This feature allows the user to choose what changes to save to the ECU during a tuning session. Target – Revert modifications (Hot Key – CTRL + SHIFT + R) removes any changes not previously saved. At key off, the system will automatically commit all unsaved changes if the Key Off Commit option is checked in the Tuning Preferences Setup Wizard page. AEM recommends disabling the Key Off Commit options once all tuning changes are made.

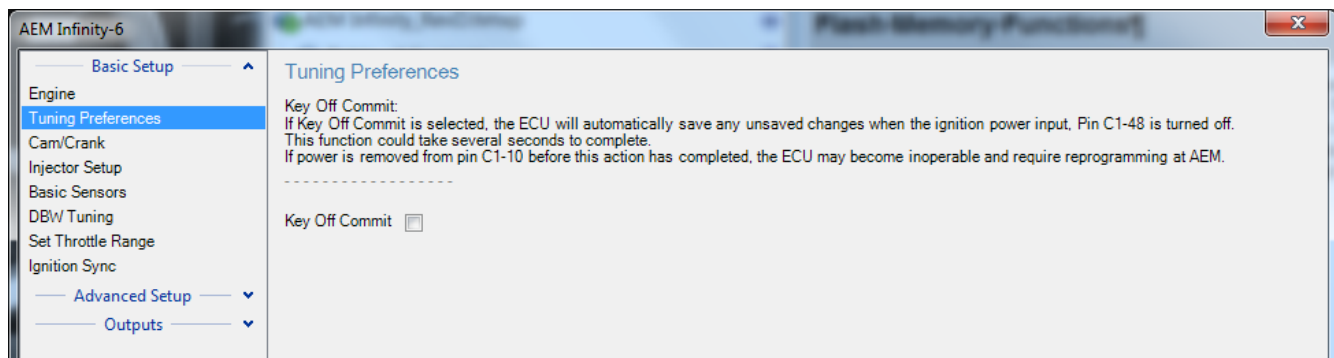

Getting Started

File Extensions:

The Infinity EMS software uses several different file naming conventions.

.ITSSN

This file represents a Session (or Calibration). AEM provided base sessions are installed to the following location:
\Documents\AEM\Infinity Tuner\Sessions\Base Sessions

.ITLOG

This file is created when saving a Log.

.ITLYT

This file is created when making a Layout. Layouts allow the user to customize the way information and data is presented on the screen. AEM provided sample layouts are installed to the following location: \Documents\AEM\Infinity Tuner\Layouts

.PDF

These are Adobe Reader files. All documentation is in this format. AEM provide instructions are installed to the following location: \Documents\AEM\Infinity Tuner\Instructions

File Menu

In the Infinity Tuner software, select the **File** drop down menu.

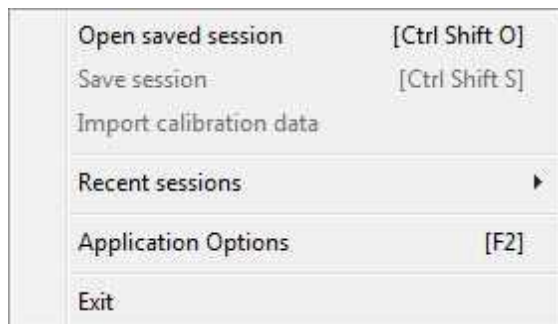

Open saved session:

Opens the background models from a previously saved session. Opening a session implies connecting to the offline Infinity simulator.

Save Session:

Saves the current session. If logged data is included in the session, two files will be saved with this command:

.itssn – the configuration and calibration data

.itlog – the logged data file

Import calibration data:

Imports modifiable data such as calibration changes to tables, etc. This command allows the download of a saved calibration to the controller. The saved calibration consists created items, system Predefined items, and Unresolved External Names. The existing system calibration will be cleared before the calibration is downloaded.

Recent sessions:

Displays a listing of most recently opened session files for quick reference.

Application Options:

Allows fine tuning of many application preferences. Clicking on...or hovering the mouse over each setting will display a corresponding description in the lower part of the window.

The following windows will allow users to customize the Infinity Tuner application for their preferences. Adjusting these settings is optional and in most if not all cases, they will be set properly by default.

Firmware Window

These application preferences are used by the firmware upgrade window. They should be set correctly by default and should not need adjustment. They can be used in some cases for troubleshooting certain file management issues during the firmware upgrade process.

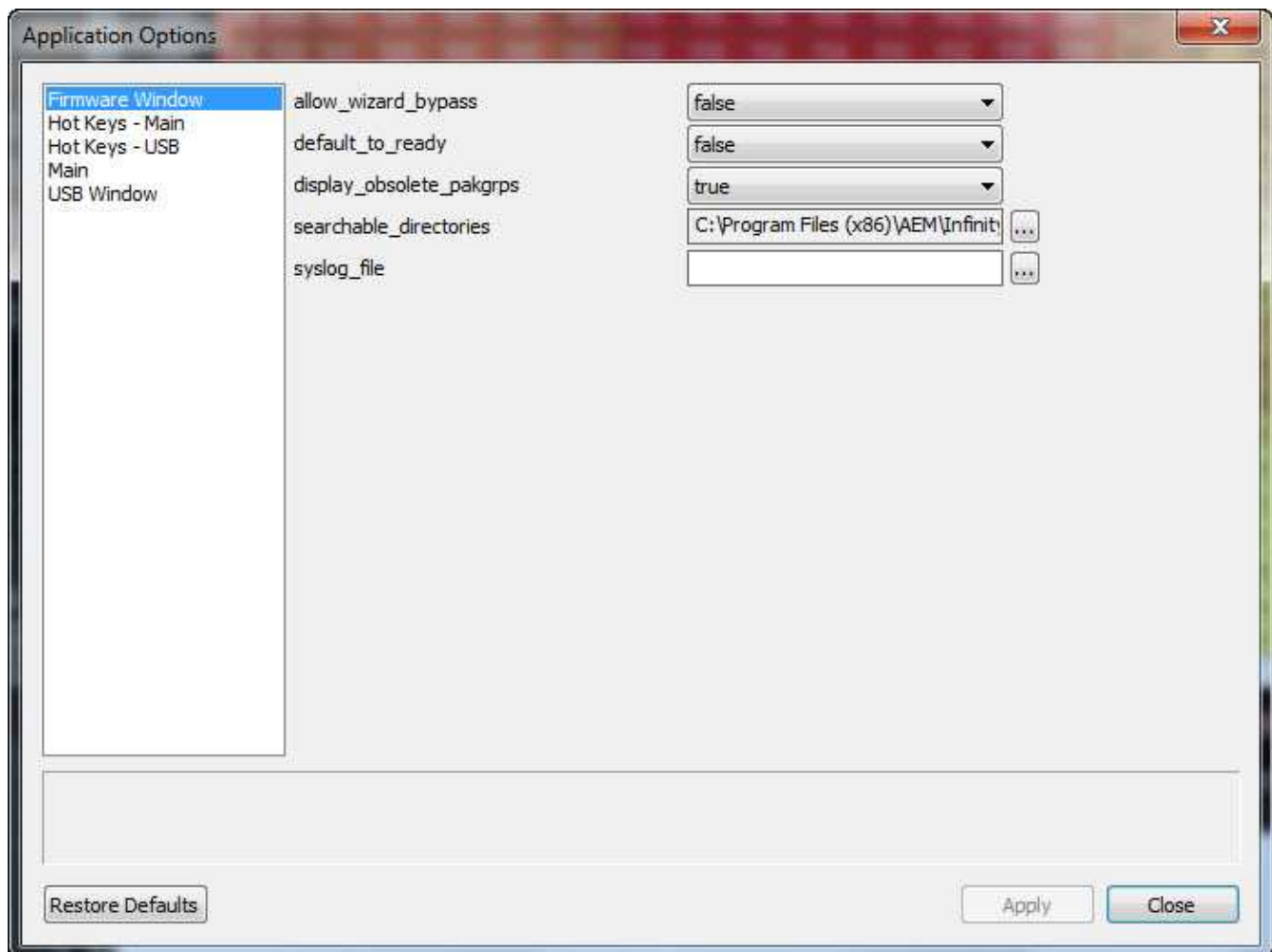
**Hot Keys – Main**

These application preferences are used to set up hot keys for most general application tasks. To change a hot key assignment, select the hot key assignment by left clicking on the button. Hit the enter key to begin recording the new assignment.

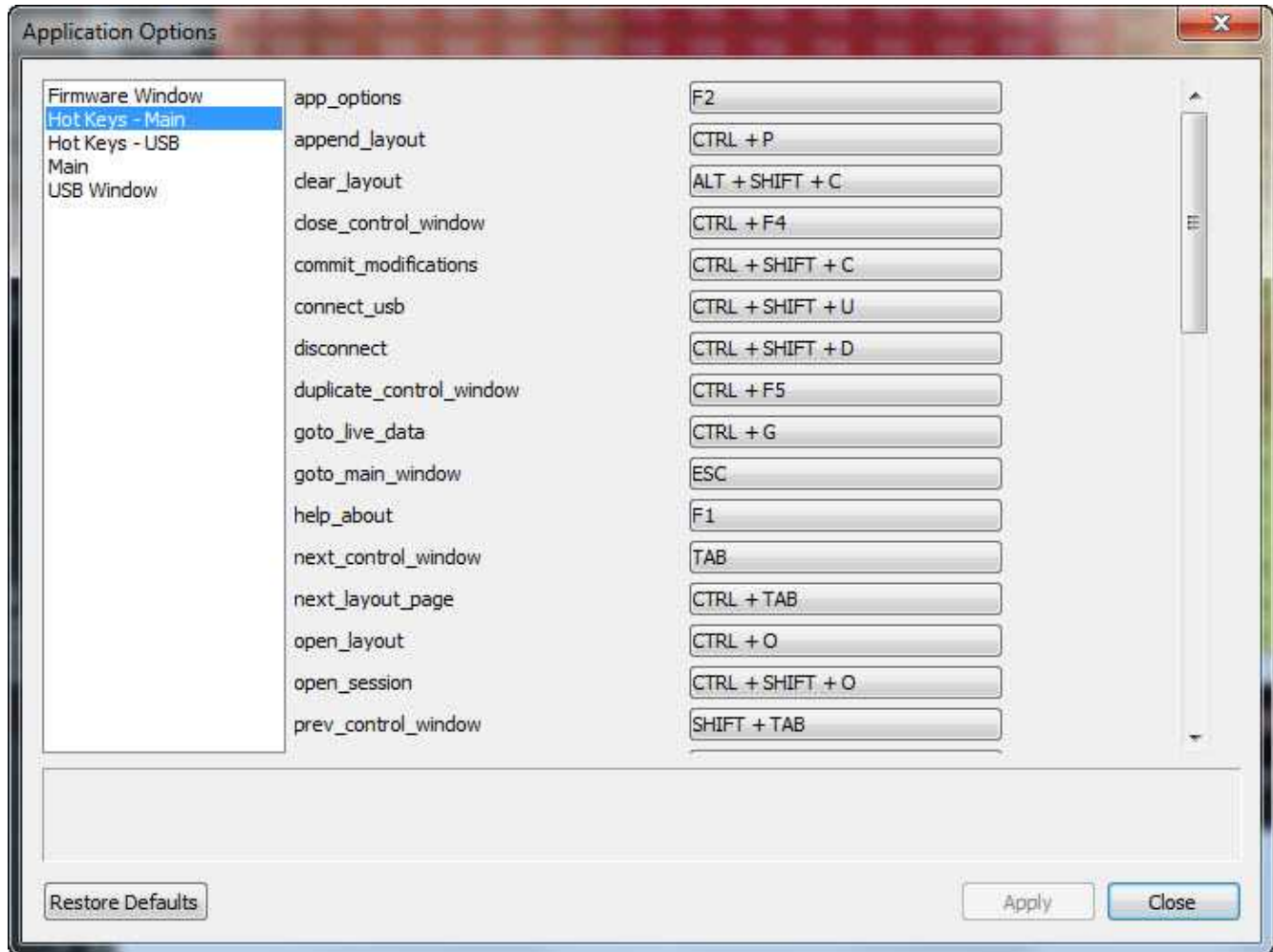

Hot Keys – USB

These application preferences are used by the *USB logging - get logs* window. They can be used in some cases for troubleshooting certain file management issues during the USB log file save process.

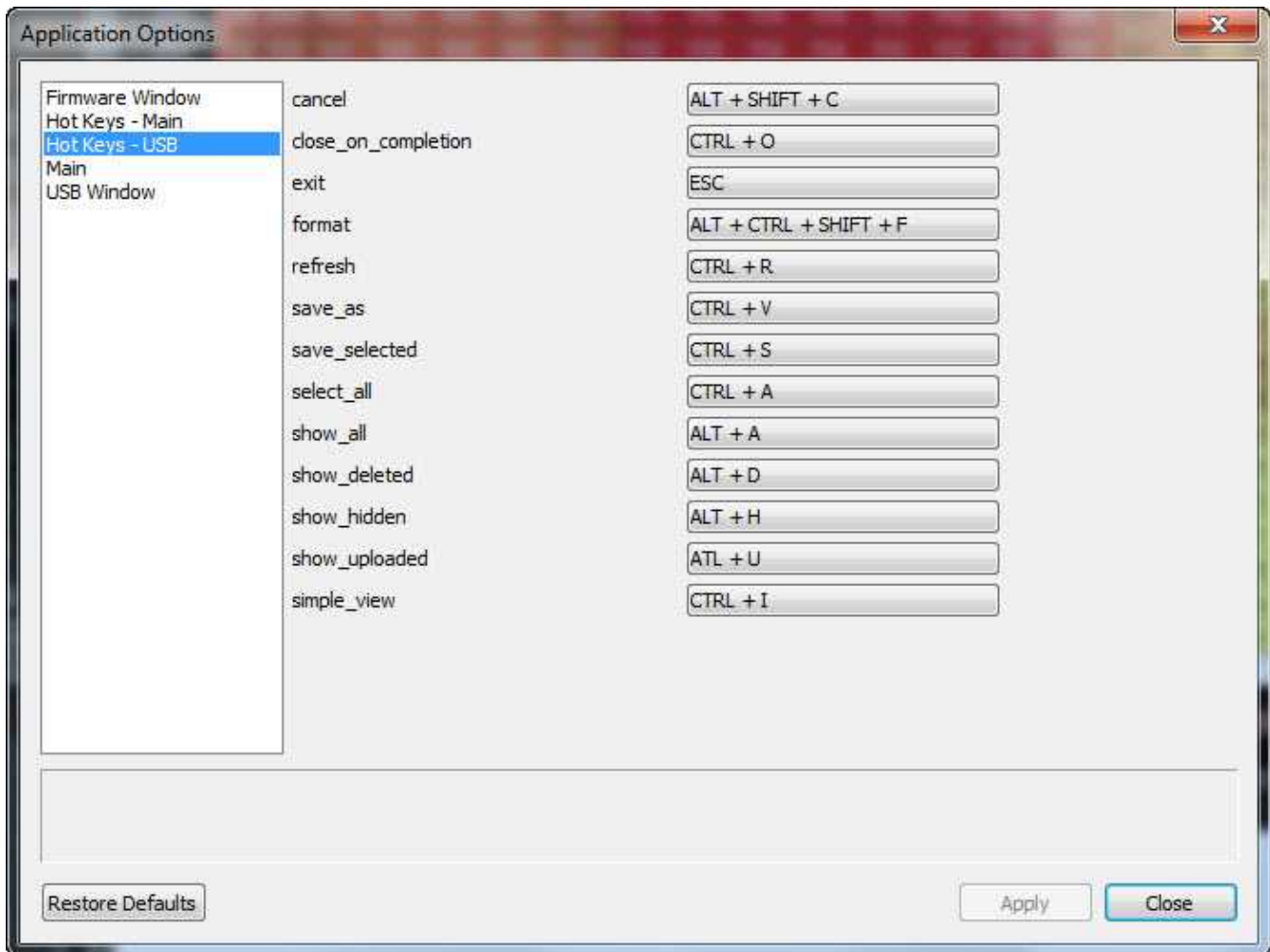
**Main**

These application preferences are used to set generic application preferences.

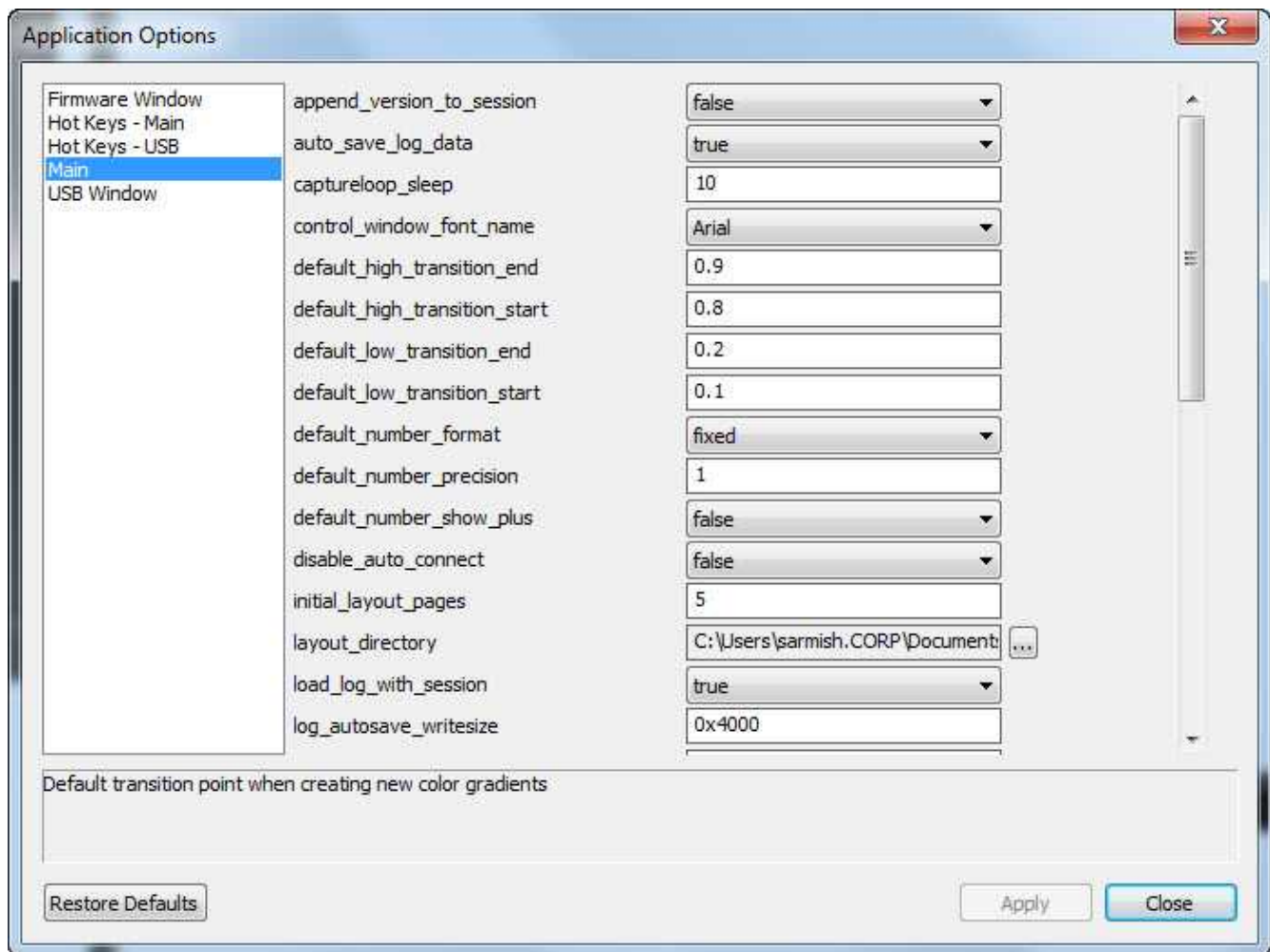

Most of these settings will be configured properly by default. The following list might be used more often by users to customize the application for their preferences:

auto_save_log_data – Periodically save PC log data to disk while logging. Takes effect when logging starts/restarts.

captureloop_sleep – This sets the PC logging frequency. The number of milliseconds between data captures from the ECU. A value larger than 1000 (1 second) will be ignored. Lower performance PCs may benefit from a value greater than 50 here. Depending on the size of the layout, values less than 20 may result in very large PC log files that take a long time to open and/or save.

layout_directory – The current directory for layouts.

load_log_with_session – Determines if .itlog files are loaded with a .itssn file is opened.

session_directory – The current directory for session files.

startup_layout – Specifies how to perform the loading of a startup layout. Will only take effect on the next launch of Infinity Tuner. Options are:

load_last
load_specific
none
prompt user

If *load_specific* is chosen, a file must be set in the *startup_layout_file* setting.

USB Window

These application preferences are used by the *USB logging - get logs* window. They can be used in some cases for troubleshooting certain file management issues during the USB log file save process.

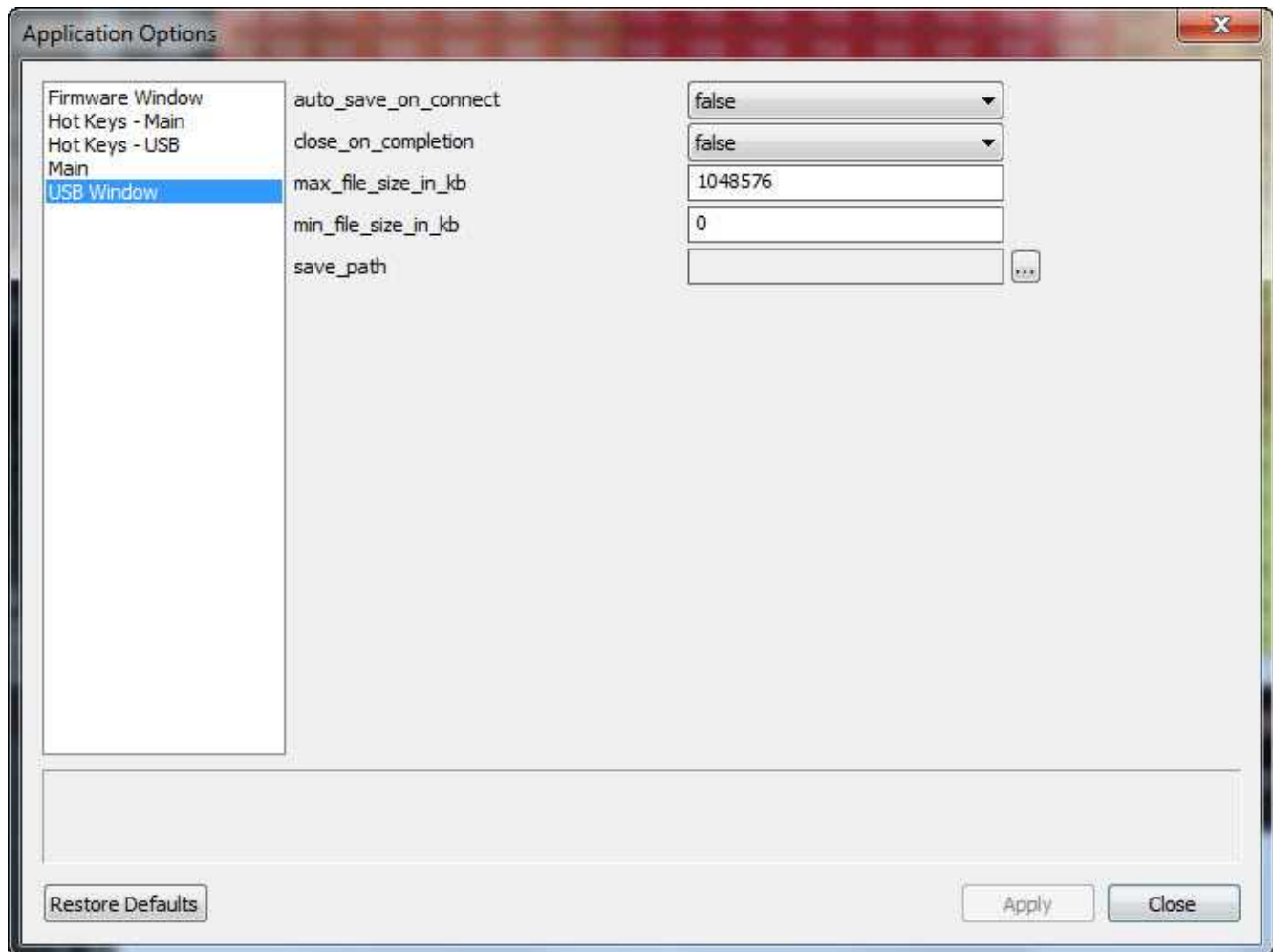

Exit:

Closes the Infinity Tuner

Connection Menu

In the Infinity Tuner software, select the Connection drop down menu.

Connect to USB:

Connects to the ECU using the USB port. The ECU must be powered properly.

Disconnect:

This option will terminate the ECU USB connection.

Target Menu

In the Infinity Tuner software, select the Target drop down menu.

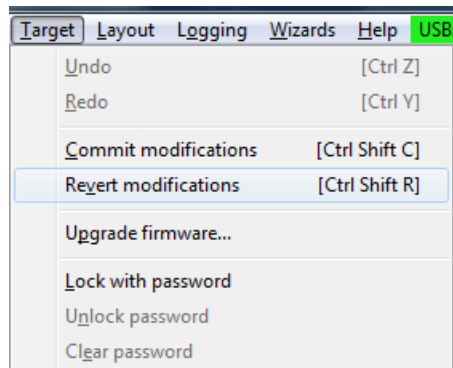
**Undo:**

Undo last commanded edit. Hot Key = Ctrl Z

Redo:

Redo last commanded edit. Hot Key = Ctrl Y

Commit modifications:

This action will update the non-volatile storage of the ECU with the users changes. The data that would be saved on the ECU includes the following:

- Table data changes.
- Initial value changes.
- "Predefined item" changes especially "Static" types.

Revert modifications:

Resets all data changed since the last time the calibration was "Committed." Once the "Commit" is performed, the changes cannot be "Reverted." The user can make changes to the table data while tuning and "Revert" the changes before "Committing." The user can always save the calibration to a file as well.

Upgrade firmware...:

The firmware update process is described in [Firmware Update](#) under the Infinity ECU Hardware section.

Lock with password:

Table data can be locked with a password on an individual channel basis.



Lock With Password

Enter password:

Confirm password:

Channels to be password protected:

Set OK Cancel

Click the Set button to select channels.

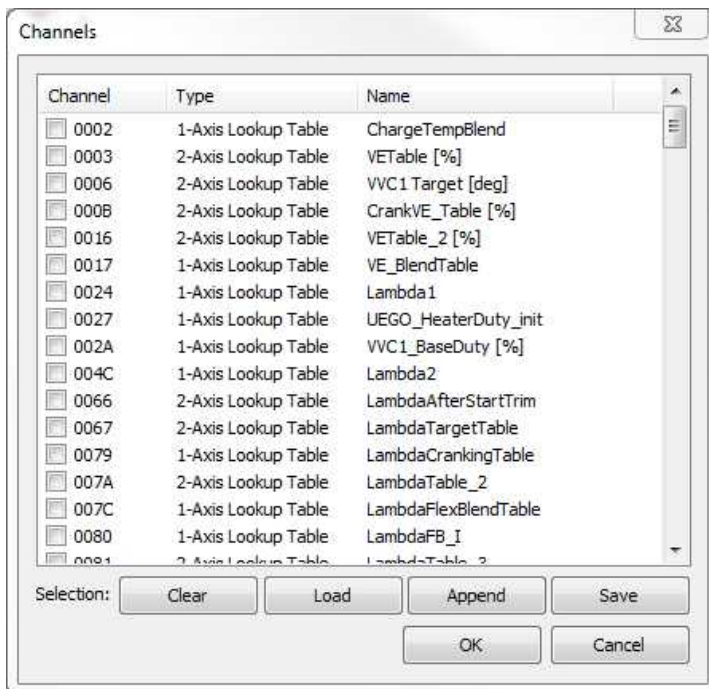

Channels

Channel	Type	Name
<input type="checkbox"/> 0002	1-Axis Lookup Table	ChargeTempBlend
<input type="checkbox"/> 0003	2-Axis Lookup Table	VEtable [%]
<input type="checkbox"/> 0006	2-Axis Lookup Table	VVC1 Target [deg]
<input type="checkbox"/> 000B	2-Axis Lookup Table	CrankVE_Table [%]
<input type="checkbox"/> 0016	2-Axis Lookup Table	VEtable_2 [%]
<input type="checkbox"/> 0017	1-Axis Lookup Table	VE_BlendTable
<input type="checkbox"/> 0024	1-Axis Lookup Table	Lambda1
<input type="checkbox"/> 0027	1-Axis Lookup Table	UEGO_HeaterDuty_init
<input type="checkbox"/> 002A	1-Axis Lookup Table	VVC1_BaseDuty [%]
<input type="checkbox"/> 004C	1-Axis Lookup Table	Lambda2
<input type="checkbox"/> 0066	2-Axis Lookup Table	LambdaAfterStartTrim
<input type="checkbox"/> 0067	2-Axis Lookup Table	LambdaTargetTable
<input type="checkbox"/> 0079	1-Axis Lookup Table	LambdaCrankingTable
<input type="checkbox"/> 007A	2-Axis Lookup Table	LambdaTable_2
<input type="checkbox"/> 007C	1-Axis Lookup Table	LambdaFlexBlendTable
<input type="checkbox"/> 0080	1-Axis Lookup Table	LambdaFB_I
<input type="checkbox"/> 0081	2-Axis Lookup Table	LambdaTable_2

Selection: Clear Load Append Save

OK Cancel

This dialog allows the user to select channels for password protection. Manually select channels by left clicking on the check box or alternately by using the arrow keys to scroll through the list and the space bar key to select. Lists can be saved for later use by using the Save button. The Load button will load previously saved lists of channels. The Append button will append a different list of channels onto the existing list of selected channels. Enter and confirm the password to set.

Clear password:

An existing password can be cleared but all data in the protected channels will be cleared as well and usually set to all zeros.



Layout Menu

The Layout feature controls how the channels within Infinity Tuner are used and viewed. In the Infinity Tuner software, select the Layout drop down menu.

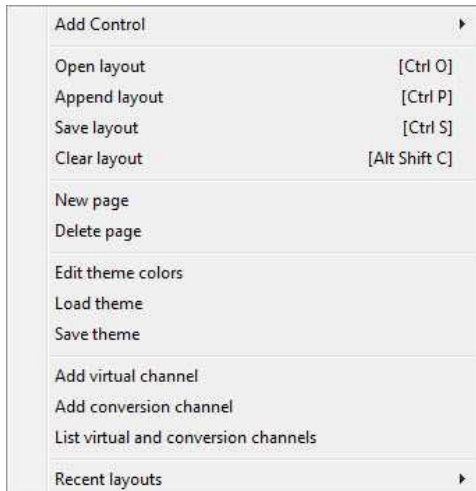

Add Control:

Adds a new control window to the existing layout. See [Software>Control Windows](#) ^[21] for more detail.

Open layout:

Opens a new layout file

Note that layout files can be saved as shortcuts. Clicking the shortcut will launch Infinity Tuner and load the layout file.

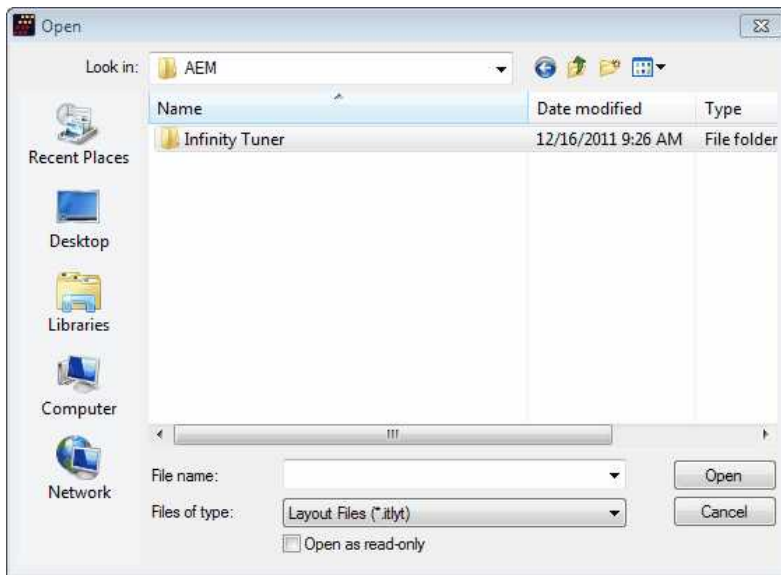
**Append layout:**

This function can be used to append layout controls from another file onto the current one.

Save layout:

This function saves a new layout.

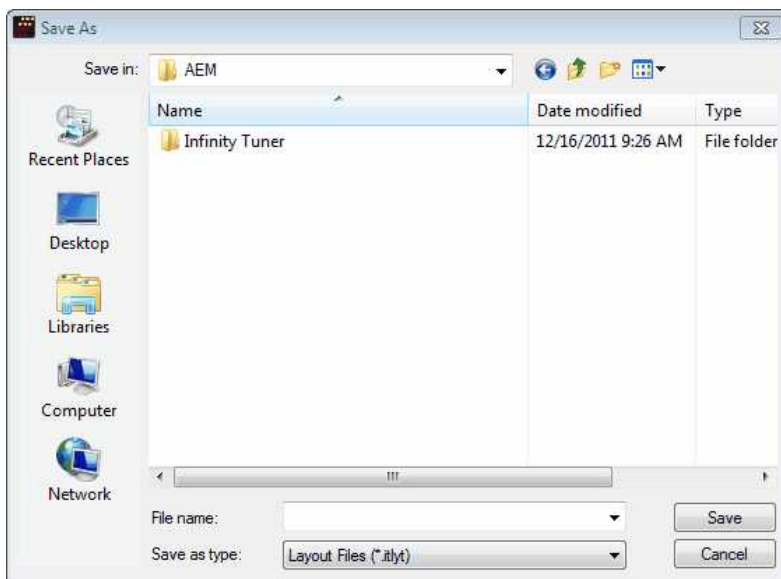
**Clear Layout:**

This feature clears all controls from the current layout.

New Page:

This function adds a new page to the layout. Note the "Page 19" tab shown below.

**Delete Page:**

This function deletes the current page selected.

- Simply select the tab that you wish to remove from the layout.
- Navigate to Layout | Delete Page.
- Make sure to save the layout if you would like to keep these changes.

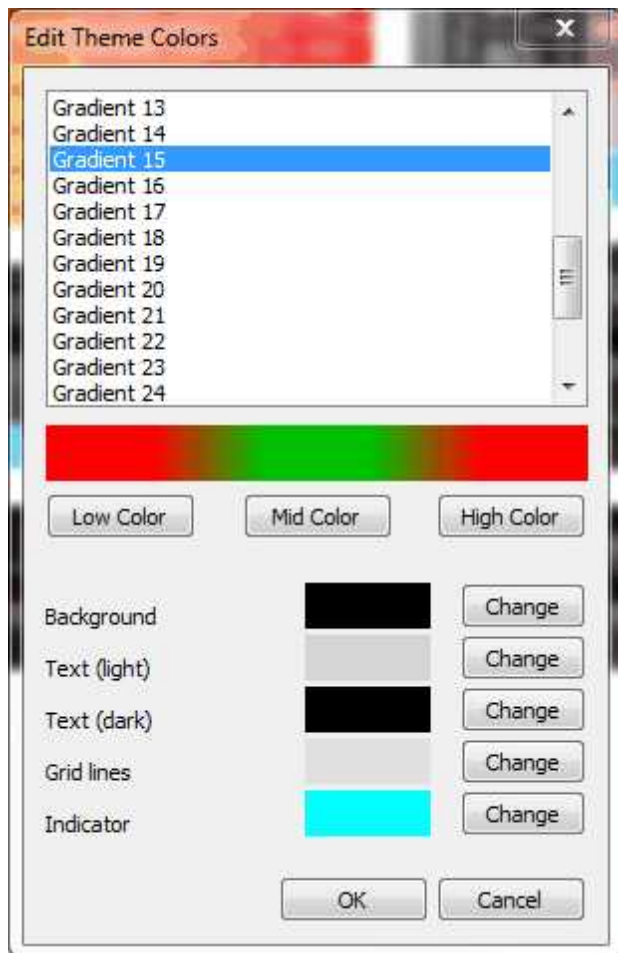
Edit Theme Colors:

The complete look of Infinity Tuner can be customized from within this dialog. Up to 30 individually customizable gradients can be used to configure colors to user preferences. Background colors, text colors grid lines and indicator colors can all be customized.

Load theme:

This feature loads a previously saved theme.

Save theme:

Use to save a new theme file.

Add virtual channel:

This function allows the user to add a virtual channel. See [Software>Virtual and Conversion Channels](#)^[35] for more detail.

Add conversion channel:

This function allows the user to add a conversion channel. See [Software>Virtual and Conversion Channels](#)^[35] for more detail.

List virtual and conversion channels:

This function all available virtual and conversion channels and allows editing. See [Software>Virtual and Conversion Channels](#)^[35] for more detail.

Recent layouts:

Displays a list of recently used layout files for quick reference

Default Layouts

AEM includes a selection of version specific layouts with each software installation. Default layouts are saved to your \Documents\AEM\Infinity Tuner\Layouts\

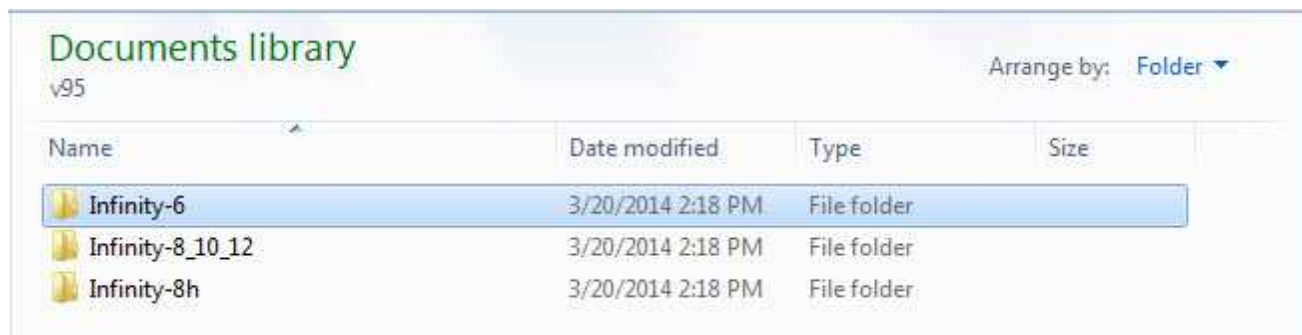

Layouts are further separated by hardware platform, Infinity-6, Infinity-10, etc.

Within each folder is a listing of available layouts. Depending on the situation, different layouts may work better and of course, they can be further customized as needed.

Log Menu

By clicking the Logging drop down menu, the following options are available:

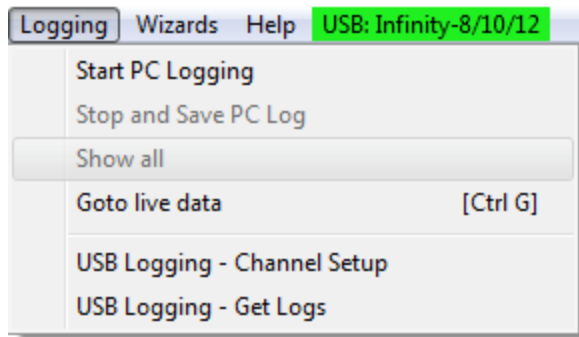
**Start PC Logging:**

When selected from the navigation bar, this data logs all channels.

Stop and Save PC Log:

Selecting this option while recording will turn OFF the log. A current log will be lost once a new log starts. To save a log, be sure to do a Save Session from the File Menu.

Show all:

Selecting this option will show all logs.

Goto live data:

Quick function that allows transition from log viewing to live data

USB Logging – Channel Setup:

This dialog allows the user to select channels for USB logging. Manually select channels by left clicking on the check box or alternately by using the arrow keys to scroll through the list and the space bar key to select. Logging lists can be saved for later use by using the Save button. The Load button will load previously saved lists of channels. The Append button will append a different list of channels onto the existing list of selected channels. Note that the list of channels for logging is saved in ECU memory. Channels can't be selected offline. They can only be selected when connected to an ECU.

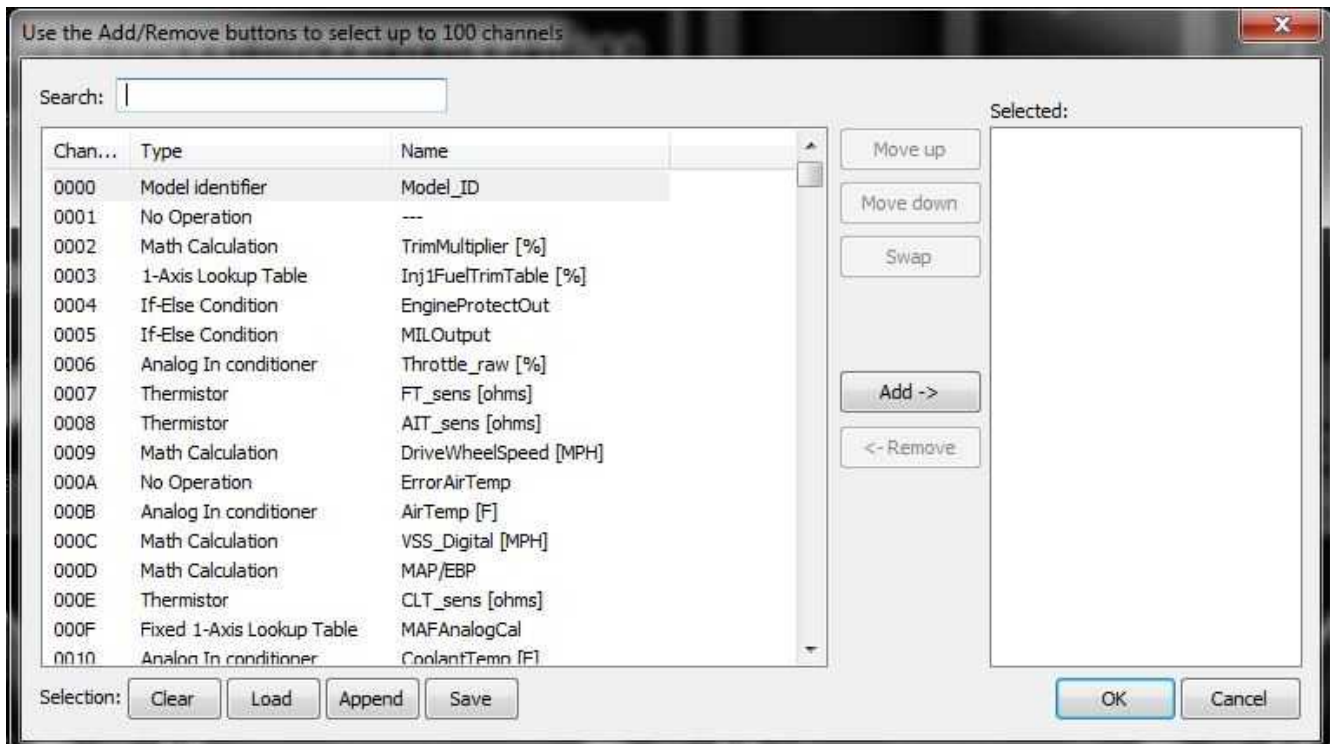

USB Logging – Get Logs:

This menu allows the user to configure the file transfer features for USB logging.

If **Auto-Save On Connect** is selected below, the system will automatically transfer file from the USB storage device to the PC when connected according to the settings in the Upload Files... dialog shown below.

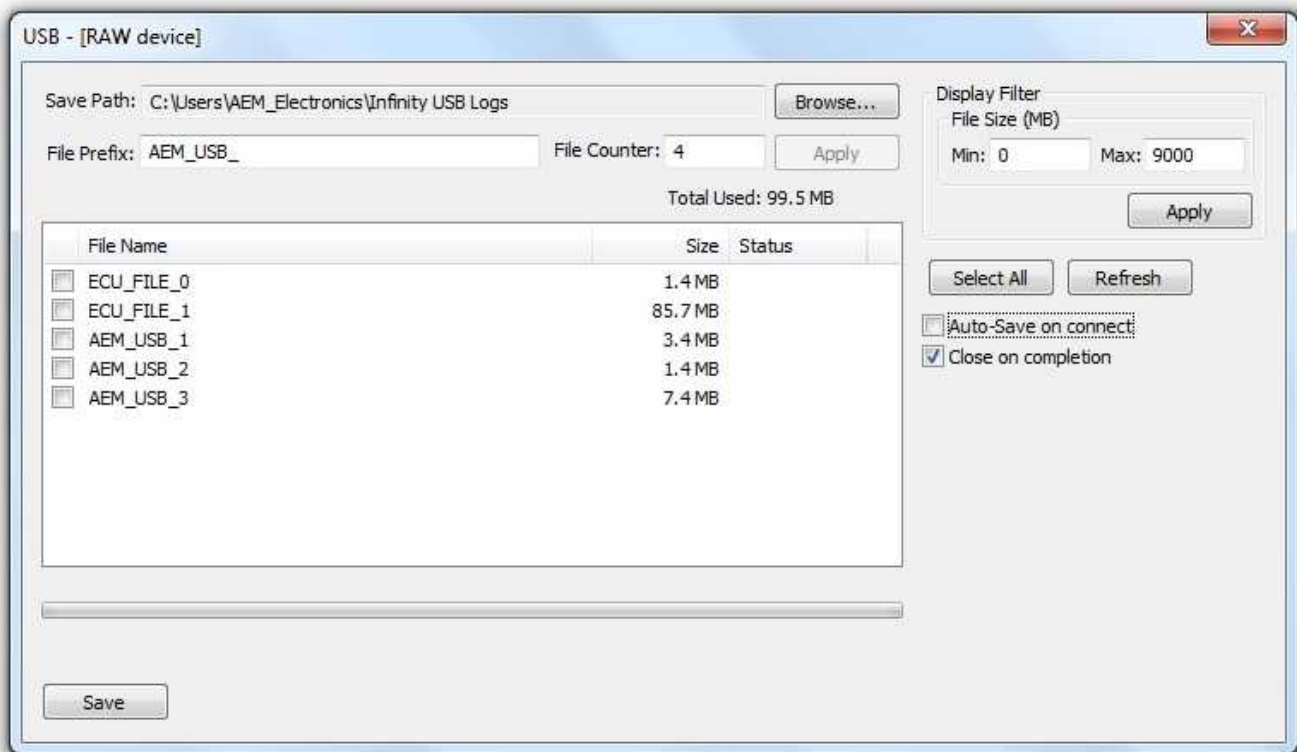

Define the save path by clicking the **Browse...** button and choosing a save folder location. A user File Prefix and File Counter can be chosen as shown in the example above. File Prefix and File Counter entries are only valid if the USB device is formatted RAW. To select the RAW formatting for the USB device, right click in the file name window and select format drive.

There is a display filter that allows the user to filter the file list for files above a certain size. All USB log files are saved individually. Every time the logging conditions are met, a file is opened. When the logging conditions are no longer met, the file is closed and saved. The Display Filter can filter out small files that may result from quick logging start/stop conditions.

To choose a list of individual files to save, select them from the list by left clicking the check box. Alternately, they can be selected by using the arrow keys and space bar to select. Under the Save category, choose to save either Selected files or All files. The Close on completion option will automatically close the dialog when the save task is complete.

The dialog will display the current status of the file transfer(s) as shown below.

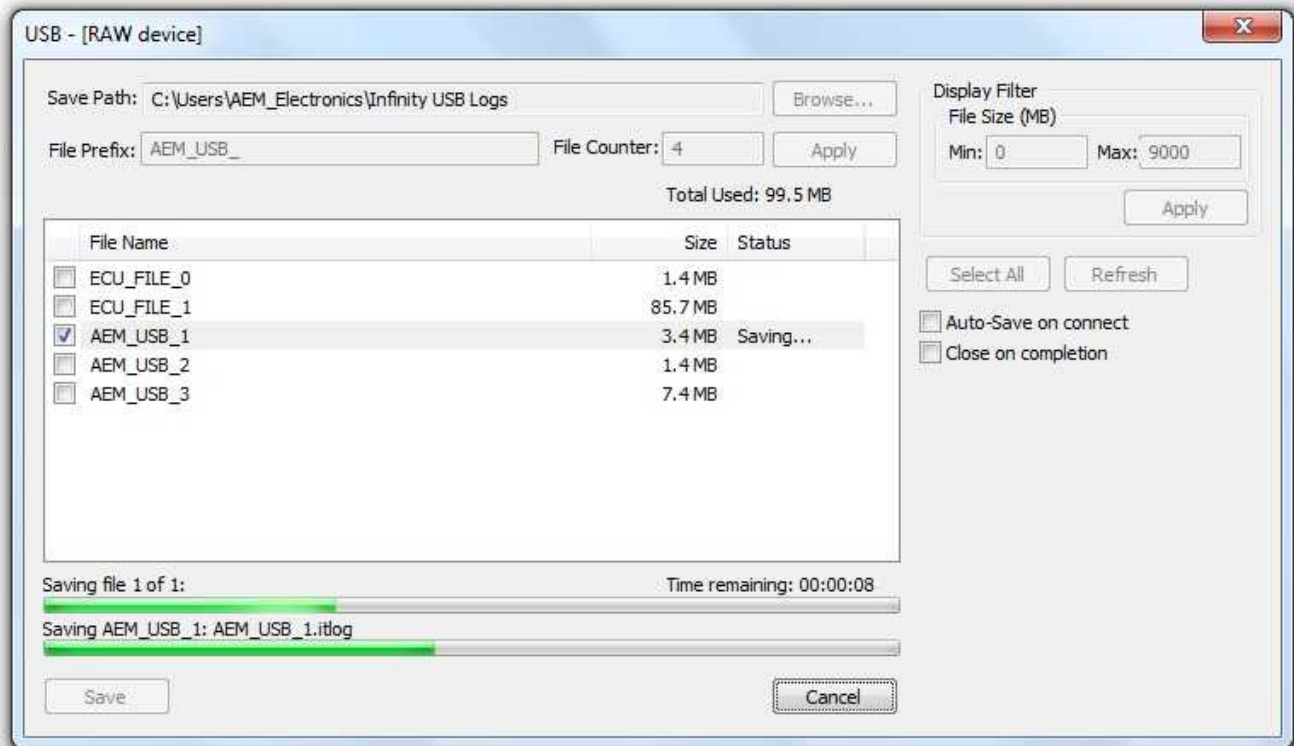

Wizards Menu

The wizards menu allows the user to select from several smart tools to aid in setup and tuning. See the [Wizard Setup](#) ⁽⁷⁹⁾ section for more information.

Help Menu

Information on the Infinity Tuner build can be found here. There is also a dialog window that displays information about the specific firmware versions installed on the ECU.

Connection Status

Various connection statuses are displayed to indicate current ECU mode from connected, simulation, or not connected.

USB: Infinity-8/10/12

Example showing USB connection to Infinity ECU

Saved session: 2014_02_27_15_34_54_0.itssn

Example showing session file opened offline

Not connected

Not connected to ECU. No session file currently opened.

USB: Unknown Board

Possible problem with board, try turning ignition off and on and ensuring C1-9 (Infinity-8/10/12) or C1-72 (Infinity-6/8h), Flash Enable is not connected to 12v

Control Windows

There are many different types of controls including: 1D Table, 2D Graph, 2D Table, 3D Graph, Bar, Gauge, Plot, Scatter Plot, Slider, Text, and Text Grid.

To create a control:

1. Select Layout > Add Control.
2. Select the desired control from the Add Control menu.

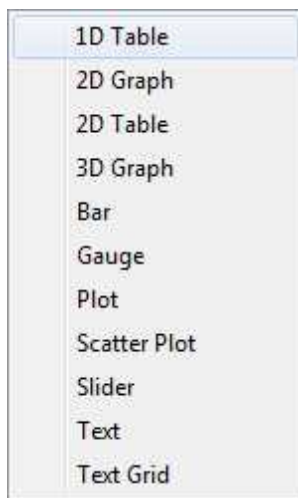

3. Select the desired channel(s) from the Channel List dialog box.
4. Click OK to access the Control Properties dialog box.
5. Adjust control property settings, if applicable.
6. Click OK to create the control and display it in the layout.

1D Table

A 1D Table represents a one-dimensional translation (one input channel). It is essentially a math calculation that maps one value to another based on a lookup table, instead of a math expression.

To add a 1D Table:

1. Select Layout > Add Control > 1D Table.
2. Right Click on the window and select Set Channel. The search field can be used to narrow your selection.

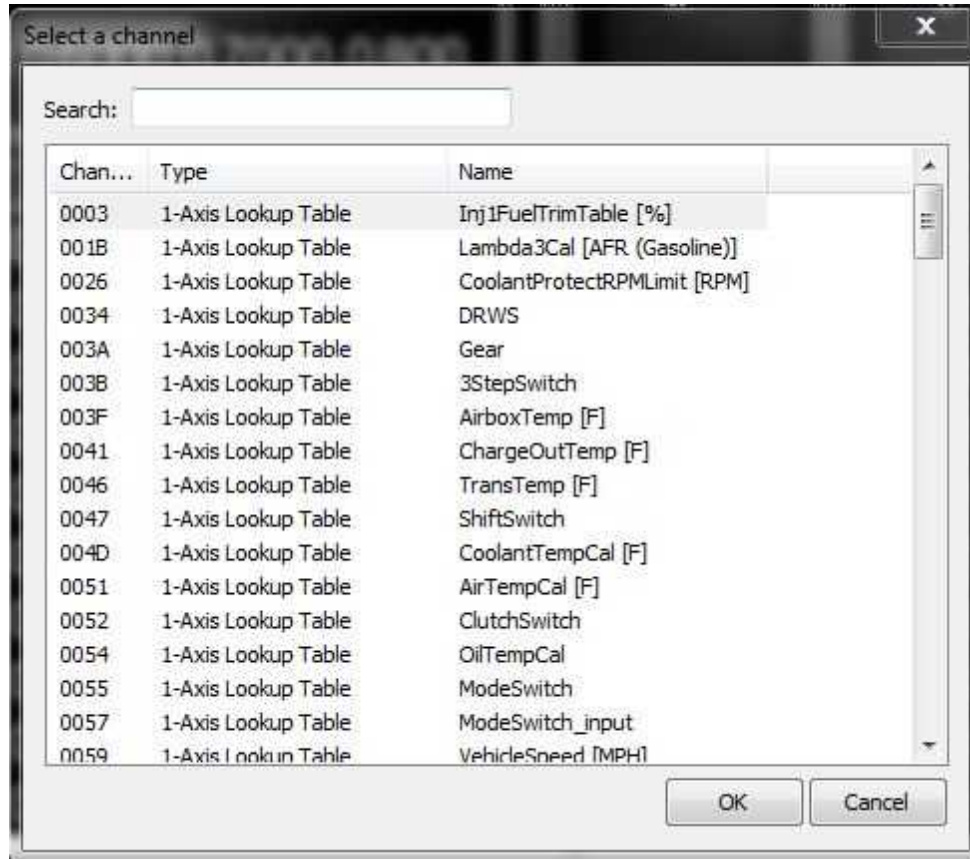

3. Select the desired 1-Axis Lookup Table from the Channel List dialog box.
4. Click OK. Example shown below.

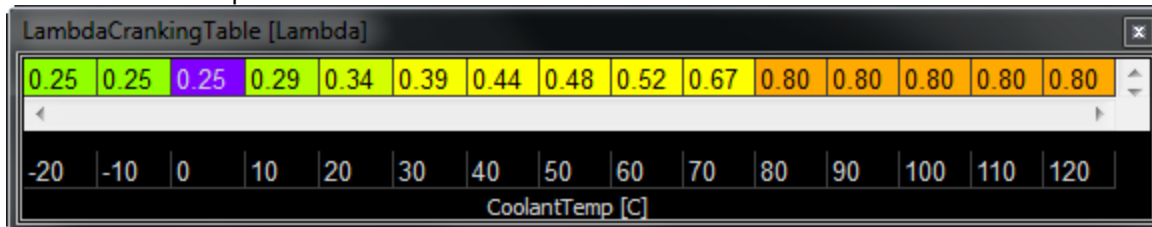

2D Graph

A 2D Graph represents a one-dimensional translation (one input channel). It is essentially a math calculation that maps one value to another based on a lookup table, instead of a math expression.

To add a 2D Graph:

1. Select Layout > Add Control > 2D Graph.
2. Right Click on the window and select Set Channel.

3. Select the desired 1-Axis Lookup Table from the Channel List dialog box.
4. Click OK.

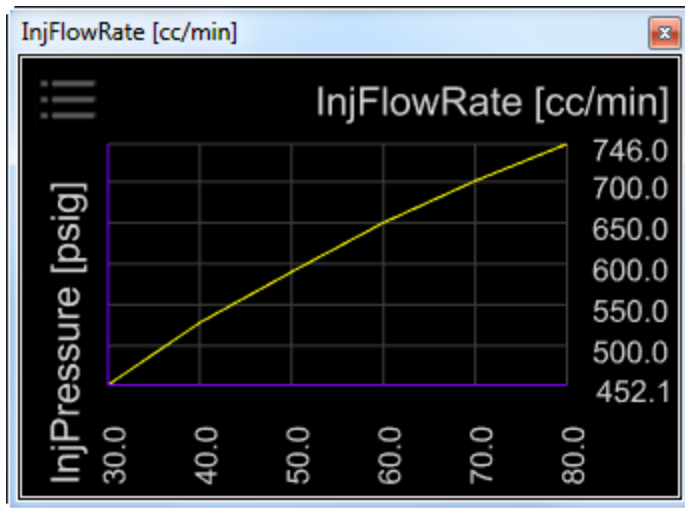

2D Table

A 2D Table represents a two-dimensional matrix (two input channels). The two inputs index into a lookup table for the output.

To add a 2D Table:

1. Select Layout > Add Control > 2D Table.
2. Right Click on the window and select Set Channel.
3. Select the desired 2-Axis Lookup Table from the Channel List dialog box.
4. Click OK.

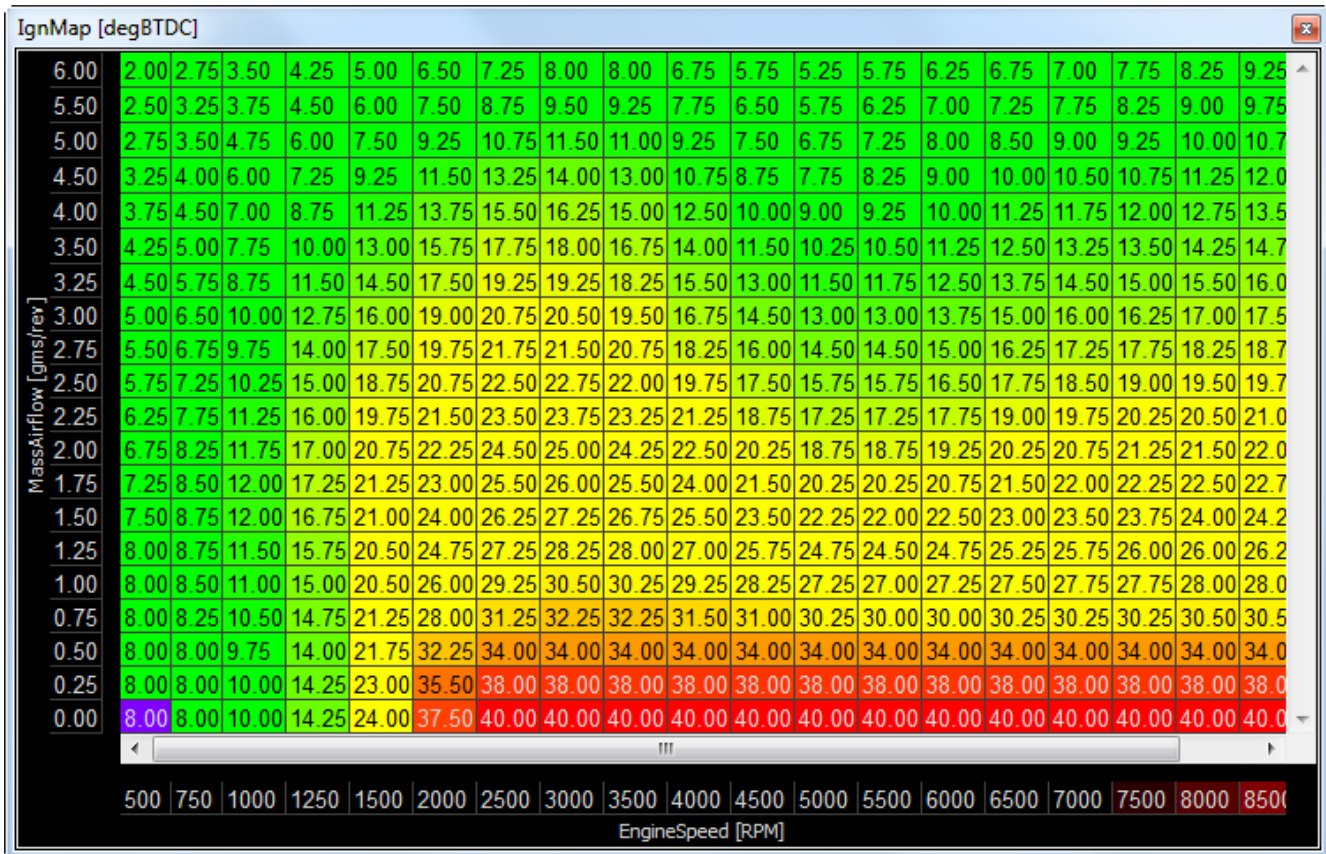

3D Graph

A 3D Graph represents a two-dimensional matrix (two input channels). The two inputs index into a lookup table for the output.

To add a 3D Graph:

1. Select Layout > Add Control > 3D Graph.
2. Right Click on the window and select Set Channel.
3. Select the desired 2-Axis Lookup Table from the Channel List dialog box.
4. Click OK. A 3D Graph provides a visual representation of one channel input relative to another channel input.

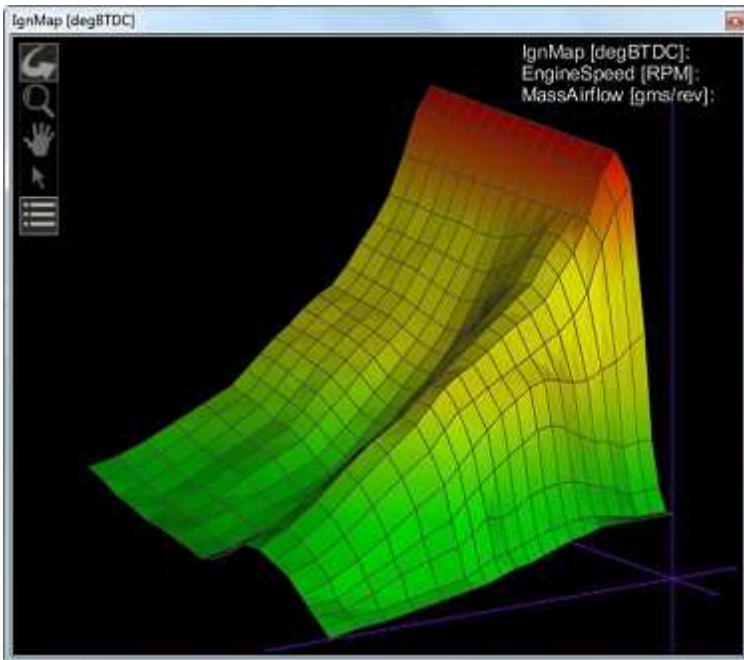

- Rotate: Rotates the 3D graph. Left-click, hold, and move the cursor to the right, left, up or down to rotate the graph right, left, up or down.
- Zoom: Zooms in and out. Left-click, hold, and move the cursor to enlarge or reduce the graph size.
- Pan: Moves the 3D graph left, right, up, or down
- Select: Selects sections of the map for editing
- Legend: Turns the legend data on/off.

Bar

A Bar is a measuring instrument that requires one input channel.

To add a Bar:

1. Select Layout > Add Control > Bar.
2. Right Click on the window and select Set Channel.
3. Select the desired Channel from the dialog box.
4. Click OK.

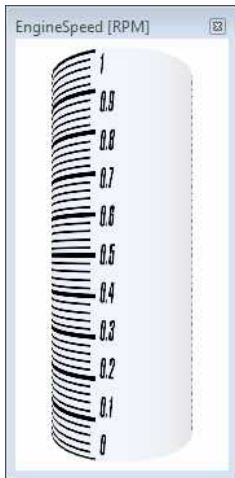

Gauge

A Gauge is a measuring instrument that requires one input channel. It is displayed as a simulated analog-style 3D model.

To add a Gauge:

1. Select Layout > Add Control > Gauge.
2. Right Click on the window and select Set Channel
3. Select the desired Channel from the dialog box and Click OK.
4. When right clicking and selecting Properties, the following dialog box appears.

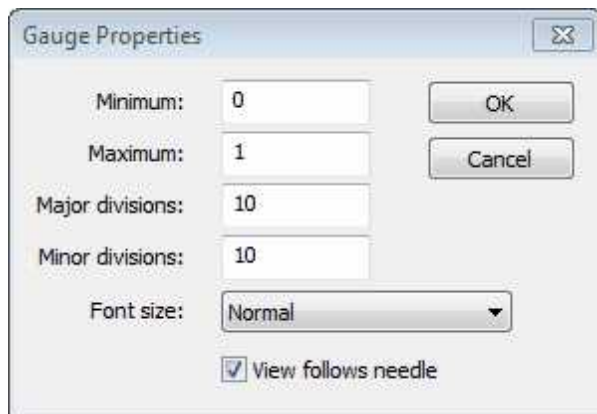

- Minimum: Minimum value for the gauge (should be greater than, or equal to, the minimum value of the selected channel)
- Maximum: Maximum value for the gauge (should be less than, or equal to, the maximum value of the selected channel)
- Major divisions: Number of major divisions in the gauge
- Minor divisions: Number of minor divisions in the gauge
- Font Size: Allows multiple sizes to be selected
- OK: Creates the gauge in the layout

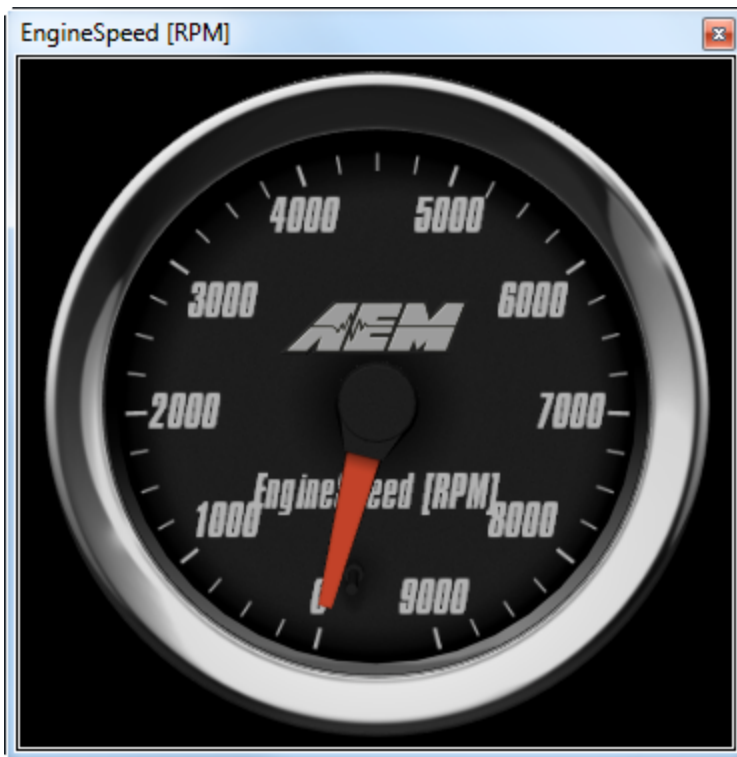

5. When right clicking and selecting Number Format Options, the following dialog box appears:

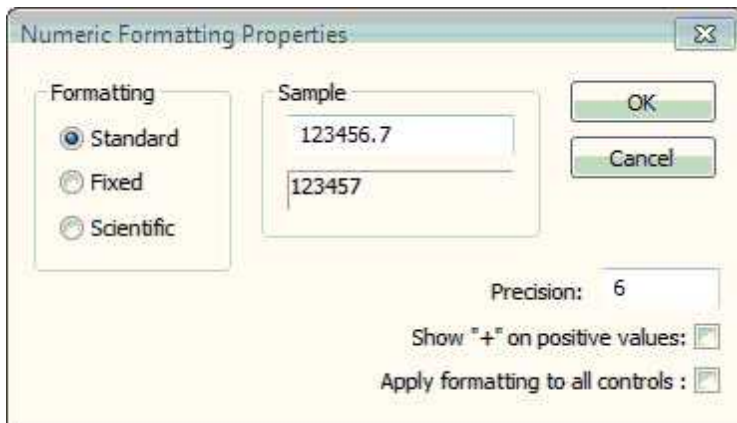

- This dialog box allows custom formats to be used such as Standard, Fixed, and Scientific numerals.
- The precision can be changed which allows for extra decimals on the values.
- Values can be represented with a "+" if they are positive.
- The custom formatting specified in this dialog box can be applied to all control using this channel.

Plot

A Plot data logs the output value of one or more channels over time. This channel requires the log to be enabled:
Log | Start Recording.

To add a Plot:

1. Select Layout > Add Control > Plot.
2. Right Click on the window and select Add Channel.

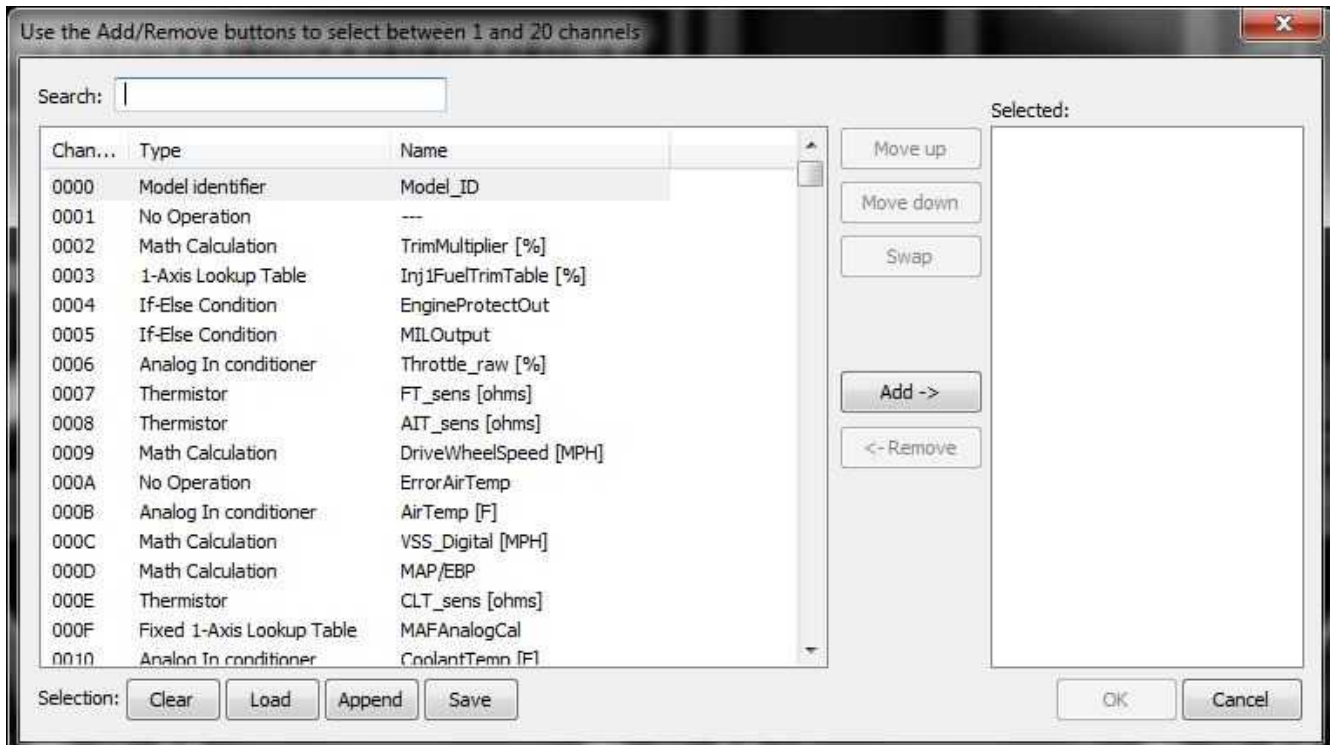

The Load button will load previously saved lists of channels. The Append button will append a different list of channels onto the existing list of selected channels.

3. Select the desired Channel from the dialog box and click OK.
4. The Y-axis represents the output value, and the X-axis represents time.

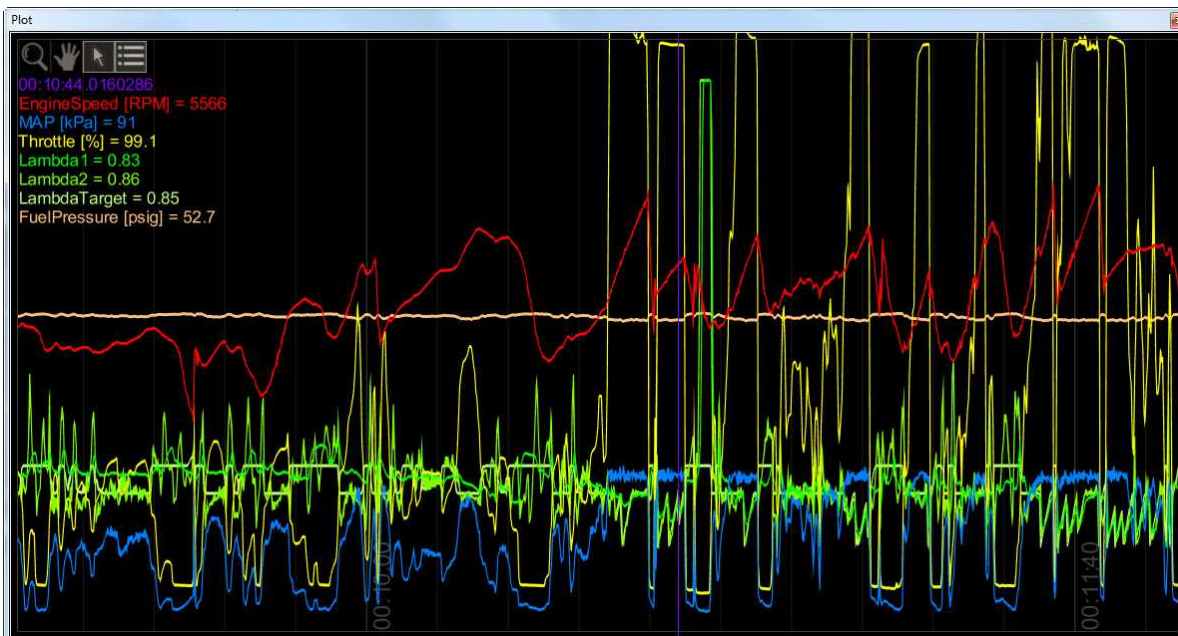

Things to do with a plot control:

- Zoom: Zooms in and out. Click, hold, and move the cursor to enlarge or reduce the graph size.
- Pan: Moves the log data forward or backward in time while staying at the current zoom level
- Auto Zoom: Will force the entire log to be displayed on each sample
- Auto Pan: Will follow the data, displaying the same length of time for each sample

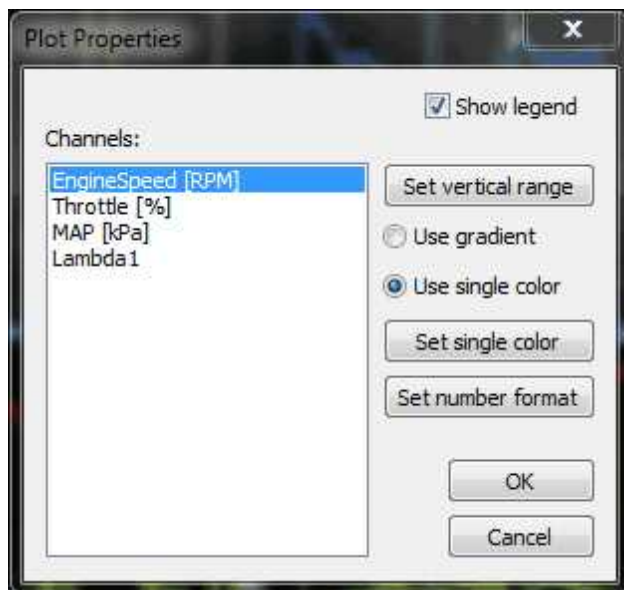

Plot Properties

- Show Legend: Toggles the legend feature in the upper right hand corner of the plot window
- Set vertical range: Sets vertical range for each channel
- Use gradient: Sets color preferences according to pre-configured gradients
- Set single color: Allows selection of a single fixed color instead of a gradient
- Set number format: Sets number format preferences for each channel

Scatter Plot

A Scatter Plot requires 2 input channels. Once the logger has been enabled (Log | Start Recording) a recorded trace of where the two channels have been operating will be viewable.

To add a Scatter Plot:

1. Select Layout > Add Control > Scatter Plot.
2. Right click and select the two desired x and y-axis channels from the Channel List dialog box.

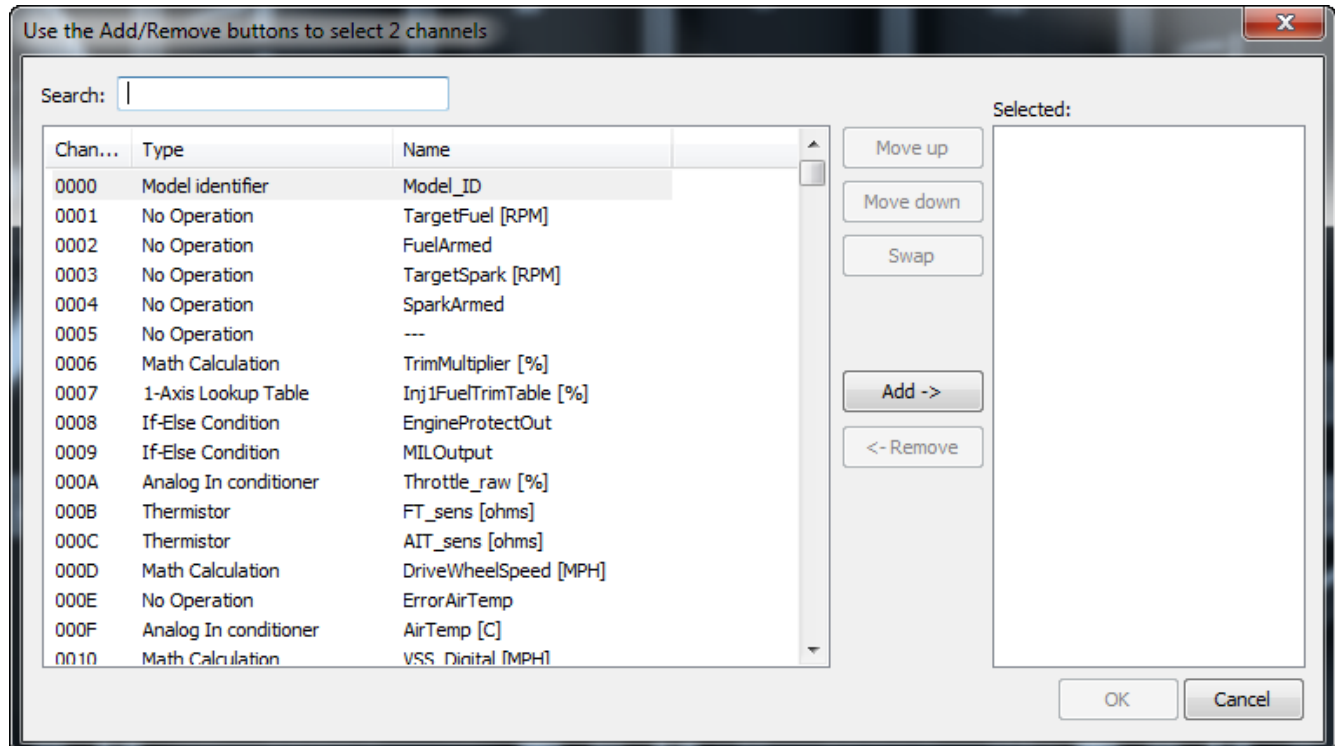

3. By right clicking and selecting Properties, the following dialog box opens.

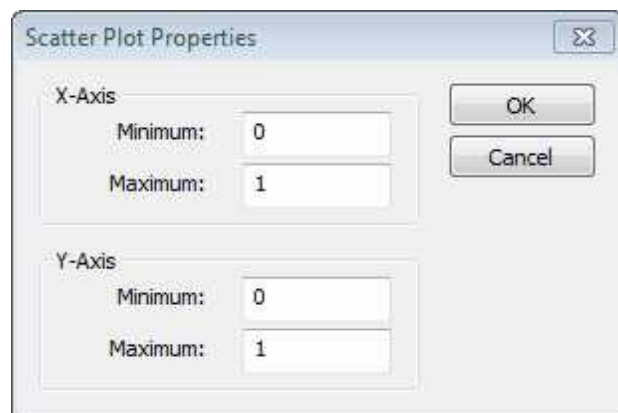

- Min Value: Minimum value for the associated X, or Y-axis
- Max Value: Maximum value for the associated X, or Y-axis

- OK: Creates the scatter plot in the layout
4. The order of the channels can be changed by using the Swap Axis.
 5. Click OK.

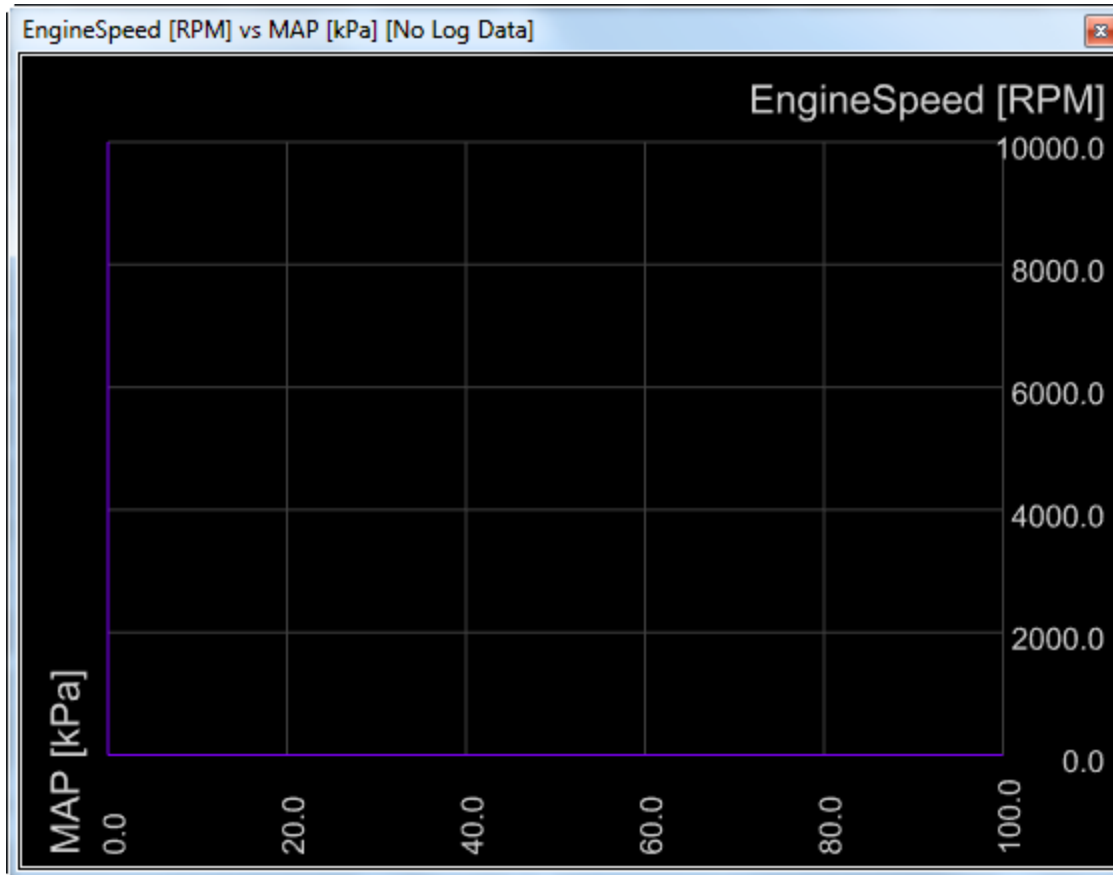

Text

Text is used to view a specific channel's current state or condition.

To add Text:

1. Select Layout > Add Control > Text.
2. Right click and select Set Channel.

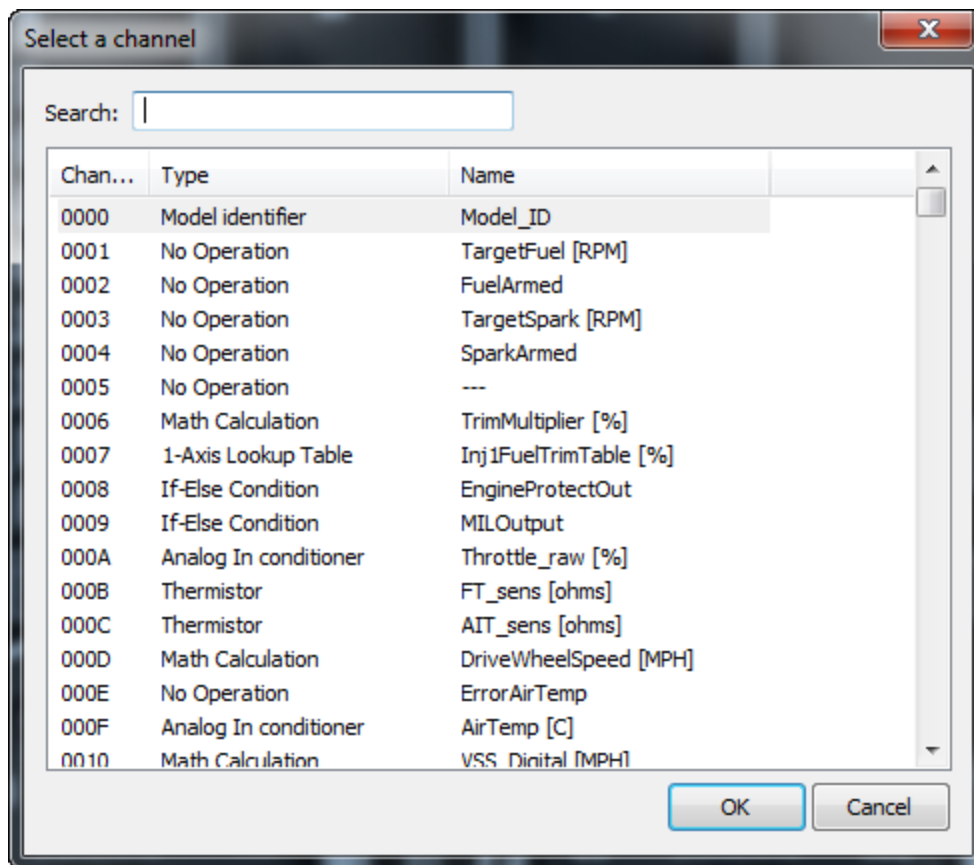

3. Select the desired channel from the Channel List dialog box.
4. Clicking OK creates the text control in the layout.
5. Display Options: When right clicking, the following options change how the control will display in the layout.
 - Initial Value: When selecting, the initial value will be displayed. This is the value saved to flash memory when changes are committed. Edit this value and commit changes if you want the change to be maintained after a power cycle.
 - Number Format Options: This dialog box allows custom formats to be used such as Standard, Fixed, and Scientific numerals.

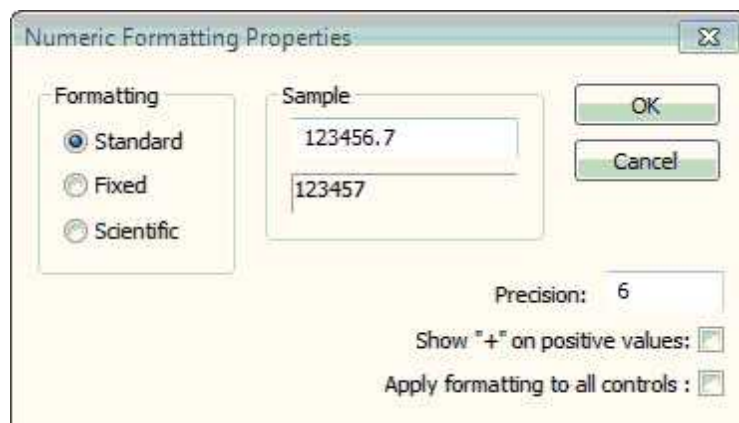

- The precision can be changed which allows for extra decimals on the values.

- Values can be represented with a "+" if they are positive.
- The custom formatting specified in this dialog box can be applied to all control using this channel.
- Color Options:

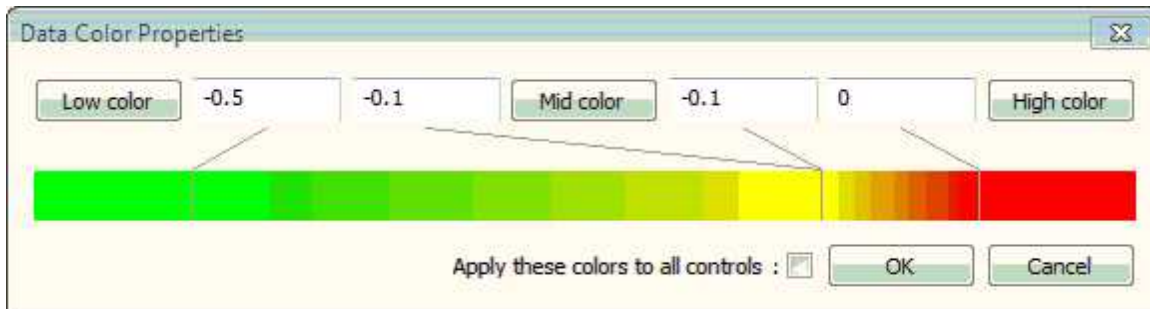

- A custom spectrum of colors can be constructed depending on the Low Color, Mid Color, and High Color specified.
- This color array can be applied to all controls using this channel.
- Move: When selected, this allows the window to be moved freely.
- Size: When selected, this allows the window to be sized appropriately.



Text Grid

Text Grid is used to view the current state or condition of multiple channels.

To add Text Grid:

1. Select Layout > Add Control > Text Grid.
2. Right click and select Set Channel.

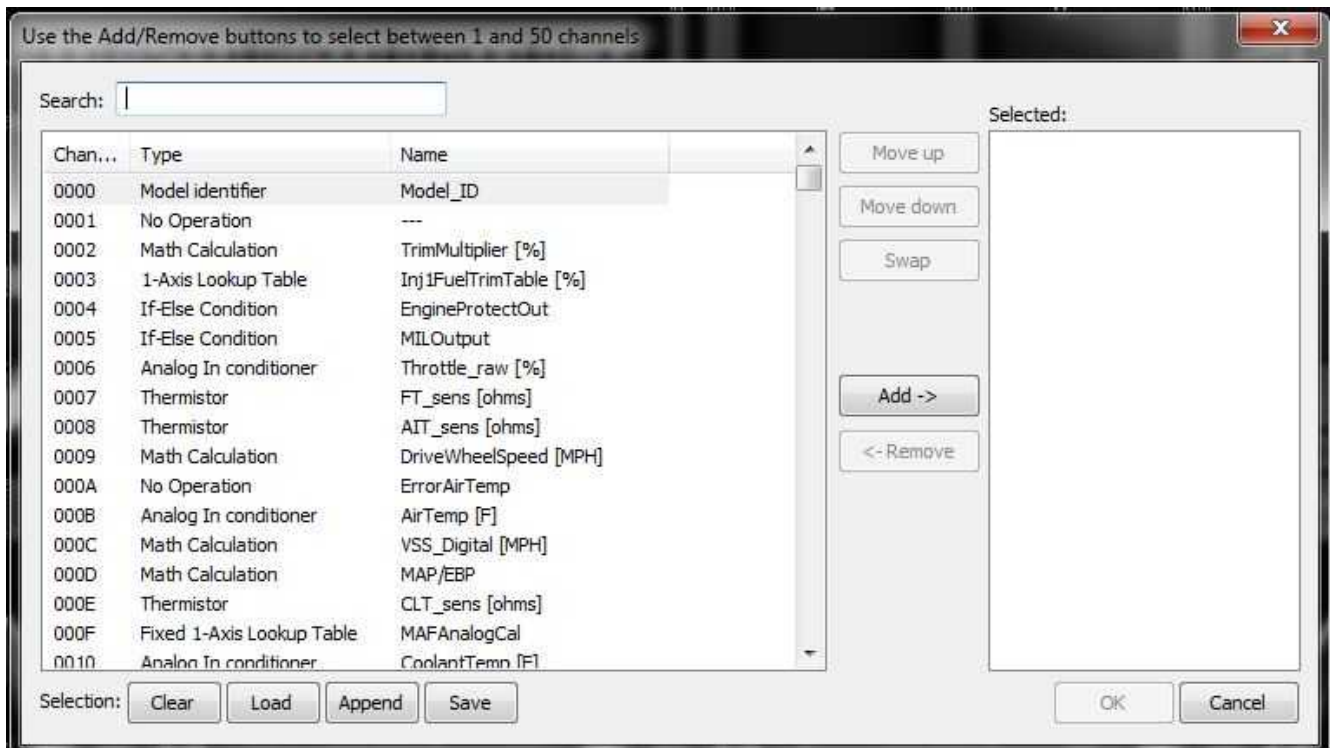

3. Select the desired channel from the Channel List dialog box.
4. Clicking OK creates the text control in the layout.

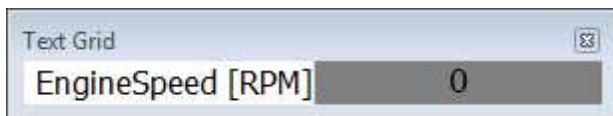

Display Options: When right clicking, the following options change how the control will display in the layout.

- Add Channel: This allows multiple to be added in rows.
- Move: When selected, this allows the window to be moved freely.
- Size: When selected, this allows the window to be sized appropriately.

When right clicking the channel, the following display options appear:

- Remove: This will remove the selected channel.
- Move Up: This will move the selected channel up one row at a time.
- Move Down: This will move the selected channel down one row at a time.
- Number Format Options: This dialog box allows custom formats to be used such as Standard, Fixed, and Scientific numerals.

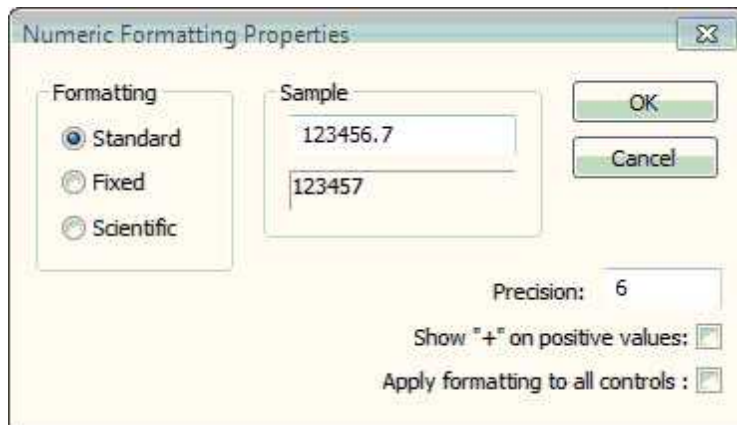

- The precision can be changed which allows for extra decimals on the values.
- Values can be represented with a "+" if they are positive.
- The custom formatting specified in this dialog box can be applied to all control using this channel.
- Color Options:

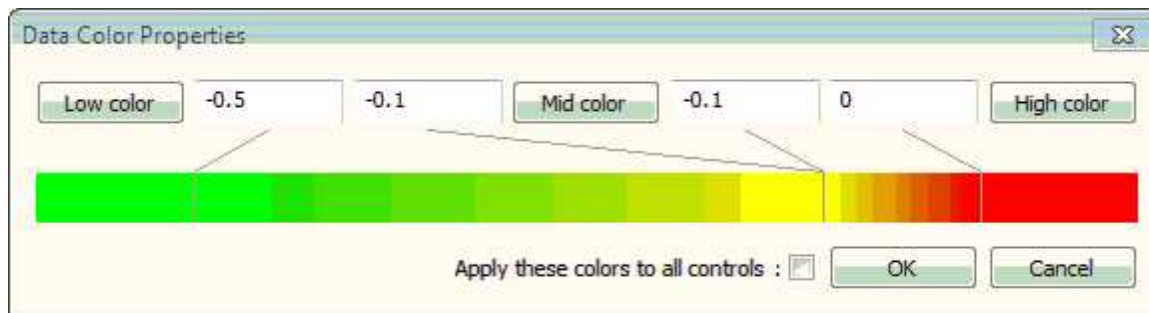

- A custom spectrum of colors can be constructed depending on the Low Color, Mid Color, and High Color specified.
- This color array can be applied to all controls using this channel.

Virtual and Conversion Channels

Virtual Channels provide you with a flexible means of defining and manipulating the raw data you are viewing in Infinity Tuner. Virtual Channels allow you to select any of the available channels present in your session and include them in custom math expressions defined by you.

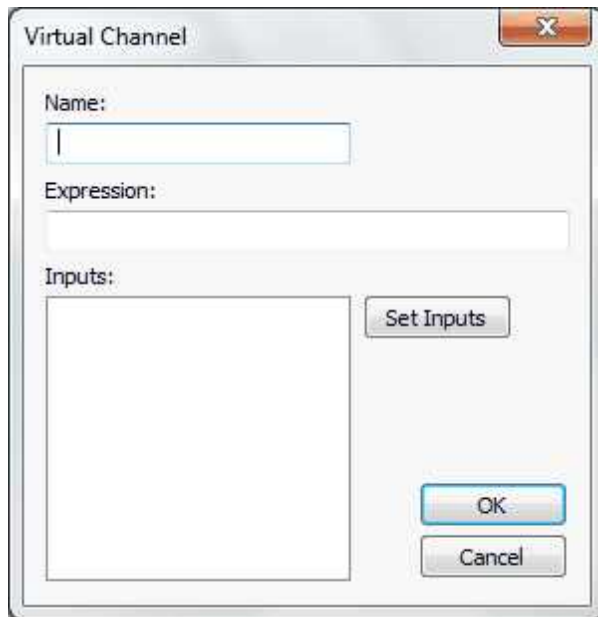
**Name:**

Enter desired name of the virtual channel being defined.

Expression:

Enter desired expression. Inputs in expressions are listed as i0, i1, i2 and so on. For details and examples of the syntax see below.

Inputs:

A list of the current channels that can be used in this virtual channel

Set Inputs: Can add/remove the channels that can be used with this virtual channel

Conversion channels provide you with a quick means of converting the values of an entire table or graph. The global units feature introduced in the April 2015 v96.1 update can take the place of this feature for most users.

Conversion channels can still be used to create unique representation of ECU data though. Once a conversion channel is created, simply right click on the table or graph and select the desired conversion channel from "Table conversion."

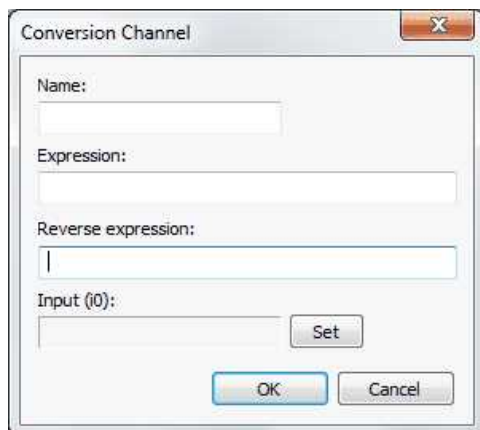
**Name:**

Enter desired name of virtual channel being defined.

Expression:

Enter desired expression. For details and examples of the syntax see below

Reverse expression:

Enter expression to convert channel back to its original value.

Set:

Select the channel you wish to create a conversion for.

Here you may review all of the virtual and conversion channels you have defined in the current session you have running. The Channel number, Type, and Name are listed in the three columns. Right clicking on any of the channels listed provides you with the option of removing the channel or editing the channel. By selecting edit, you can redefine anything about the given channel. If you made a mistake or something changes you can easily go back and make your desired changes.

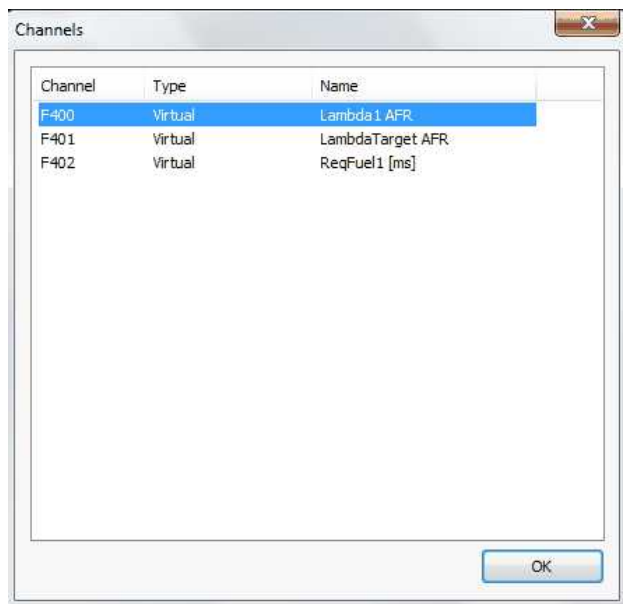

The syntax for the math expressions you can define in Infinity Tuner is fairly straightforward. The slight detail that may seem strange at first is listing the selected inputs in the expression as i0, i1, i2, and so on according to the order they appear on the list of Inputs.

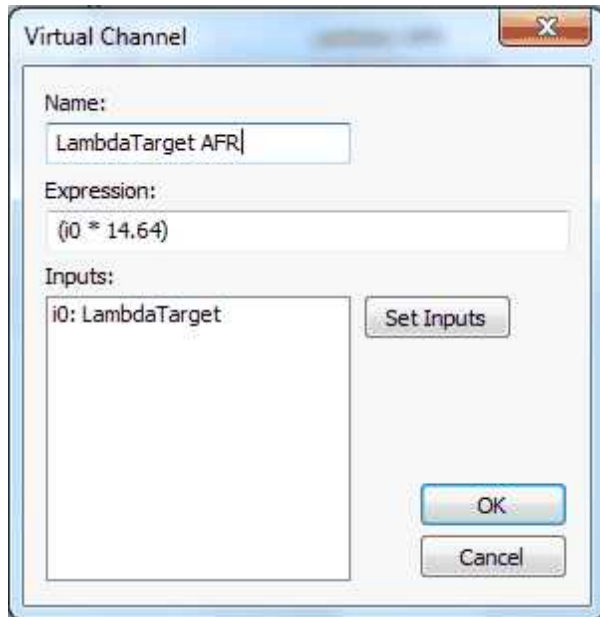

This detail may seem strange at first but is very convenient in the long run. “ $(i0 * 14.64)$ ” for the above expression for example would have had to of been typed as “ $(\text{LambdaTarget} * 14.64)$ ” otherwise.



The “ReqFuel” virtual channel illustrates the benefit of this well. You can now enter “ $i0+i1+i2+i3+i4+i5+i6+i7+i8+i9+i10+i11$ ” to add the required fuel for all of the fuel injectors. Without this syntax the expression would get overwhelmingly large fast...” $(\text{ReqFuel1 [us/10]} + \text{ReqFuel2 [us/10]} + \text{ReqFuel3 [us/10]} + \text{ReqFuel4 [us/10]} + \text{ReqFuel5 [us/10]} + \text{ReqFuel6 [us/10]} + \text{ReqFuel7 [us/10]} + \text{ReqFuel8 [us/10]} + \text{ReqFuel9 [us/10]} + \text{ReqFuel10 [us/10]} + \text{ReqFuel11 [us/10]} + \text{ReqFuel12 [us/10]}$ ”

Plot Data and Control

AEM supplied layout files will come pre-loaded with several “Plot Control” windows. (Users can always add, delete or edit them as desired.) These are special controls that allow real time data logging and playback. To begin a PC log, go to the Log menu and select Start recording or hit the “CTRL + L” hot key. Select Stop recording or hit the “CTRL + L” hot key again to stop logging. A dialog will ask if you want to save the data or not. If you select “Yes,” you will be prompted to save the current session file. A session file contains all the current configuration and calibration data along with a log file. If you open that session file again, the file will be loaded and all plot controls will be populated with the recorded data.

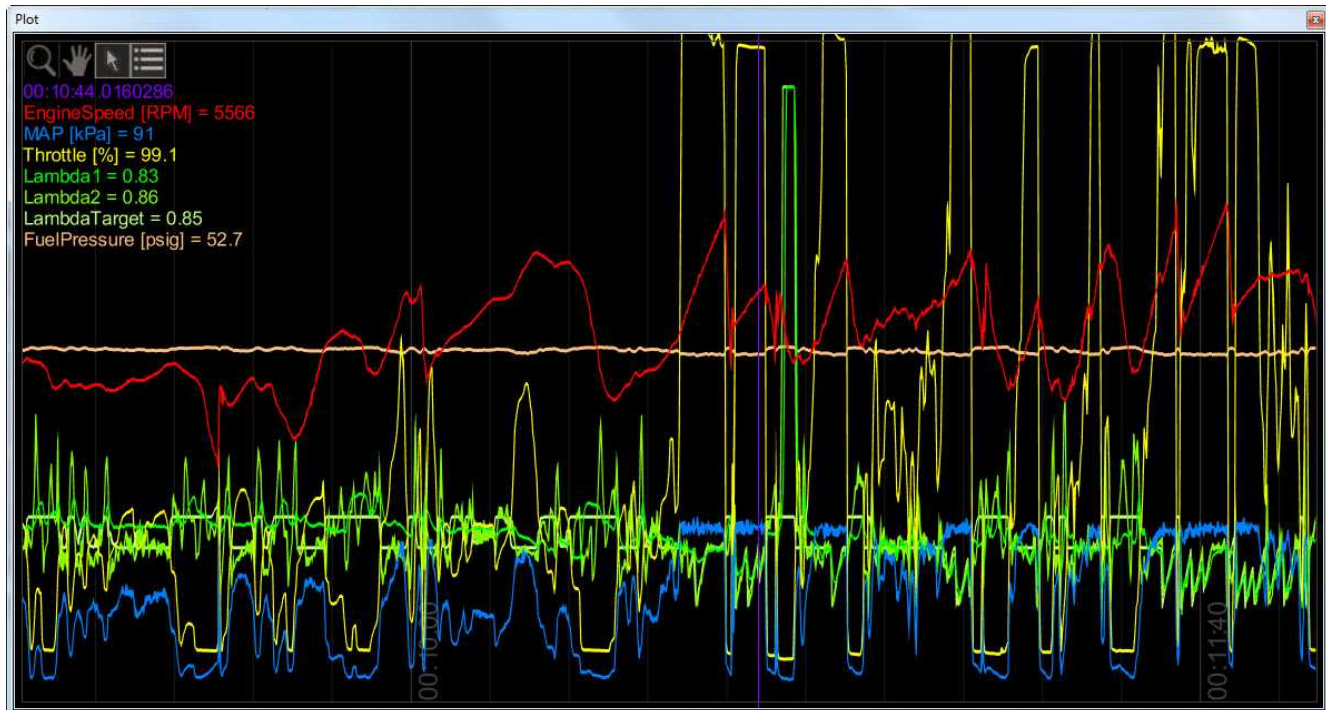

Plot Window Tools



Selection tool: Choose this icon by clicking on it then left click and drag through the plot window to view current data values.



Pan tool: Choose this icon by clicking on it then left click and drag through the plot window to pan the data left or right. Hot Key – Left/Right arrow



Zoom tool: Choose this icon by clicking on it then left click and drag up and down to zoom in and out. Alternatively, a mouse scroll wheel can be used after selecting the zoom tool. Hot Key – Up arrow/Page up, Down arrow/Page down



Show legend: Displays or hides the data legend.

Additional hot keys available in plot control window:

Home – Brings you to the start of the log

End – Brings you to the end of the log

For Home and End, the current display range is kept, so if viewing 10 seconds worth of data, Home will display the first 10 seconds while End will display the last 10 seconds.

Controls Synchronization

When the plot control is populated with data, using the selection tool and dragging through the plot will cause Infinity Tuner to synchronize all control windows to the plot data. This happens when connected to the simulator offline or when connected to the ECU via USB. To go back to viewing “live” data, go to the *Log* menu and select *Goto live data*.

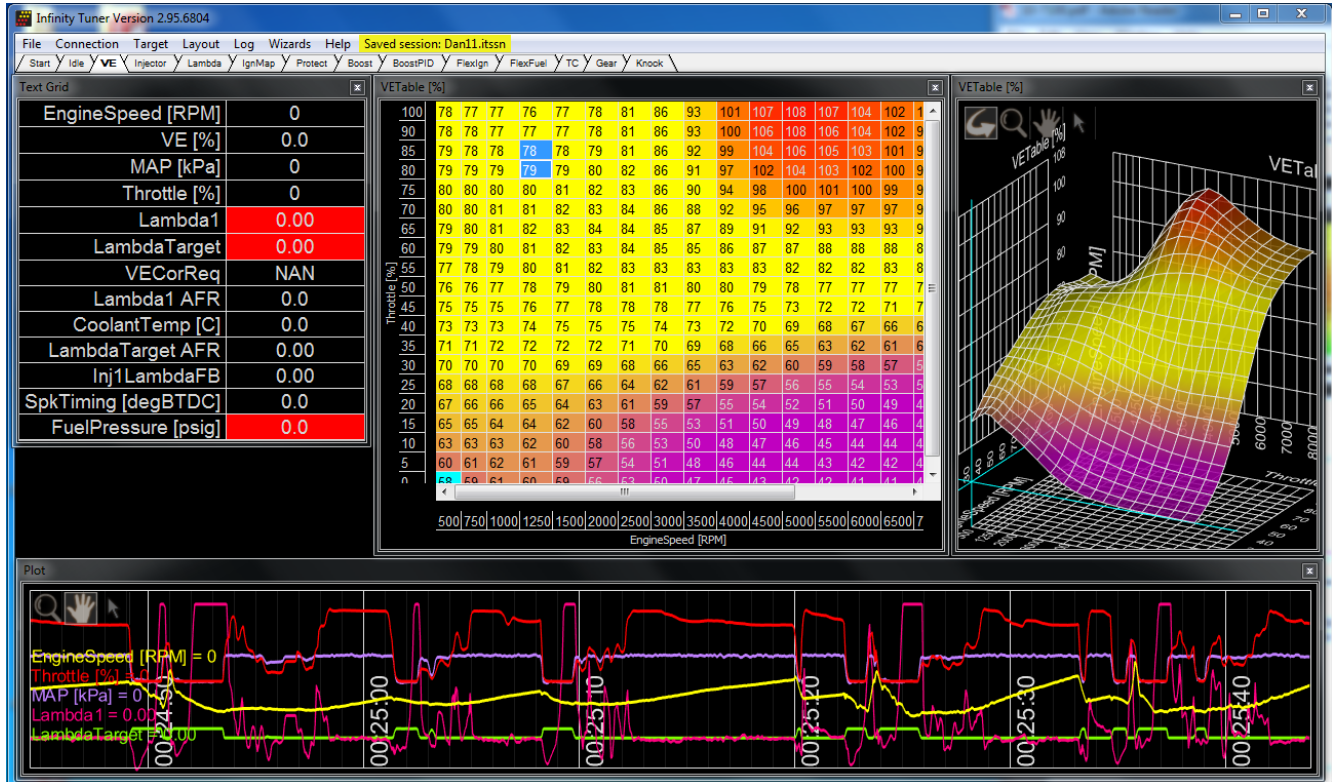

The image above shows plot data sync'd to control windows. All table cursors update with their position relative to the logged data in the plot control. Note that in this mode, table edits are still possible.

Windows Hot Keys

PCs have their own preset mapping.

- Ctrl + Alt + F3 = Enable Build-in Display
- Ctrl + Alt + F11 = Enable/Disable Panel Fitting
- Ctrl + Alt + F12 = Open Graphics and Media Control Panel
- Ctrl + Alt + UP = Rotate screen to Normal
- Ctrl + Alt + LEFT = Rotate screen 90 degrees
- Ctrl + Alt + DOWN = Rotate screen 180 degrees
- Ctrl + Alt + RIGHT = Rotate screen 270 degrees

Use the shortcut "Ctrl + Alt + F12" to open the *Graphics and Media Control Panel*, select: Options > Hot Key

Manager.



If Infinity Tuner is installed and running on a freshly installed version of windows, the Hot Key Functionality is likely enabled. If one of these preset hot keys is programmed into Infinity Tuner, this will cause an interference.

Infinity Hot Keys - Quick Reference

Commonly used Hot Keys.

Action	Default Key
Open saved session	CTRL + SHIFT + O
Save session	CTRL + SHIFT + S
Open layout	CTRL + O
Save layout	CTRL + S
Connect USB	CTRL + SHIFT + U
Disconnect USB	CTRL + SHIFT + D

Go to main window	ESC
Toggle to next control window	TAB
Toggle to previous control window	SHIFT + TAB
Next layout page	CTRL + TAB
Previous layout page	CTRL + SHIFT + TAB
Start/stop PC logging	CTRL + L
Commit modifications	CTRL + SHIFT + C
Revert modifications	CTRL + SHIFT + R
Select all	CTRL + A
Increase selected cells by 1%	=
Decrease selected cells by 1%	—
Increase selected cells by 5%	SHIFT + =
Decrease selected cells by 5%	SHIFT + —
Increase selected cells by 10%	CTRL + =
Decrease selected cells by 10%	CTRL + —
Add 1 to selected cells	U
Subtract 1 from selected cells	D
Add 10 to selected cells	CTRL + U
Subtract 10 from selected cells	CTRL + D
Smoothing using four neighboring cells	CTRL + 0
Smoothing using eight neighboring cells	CTRL + 1
Simple horizontal interpolation for 2D tables	H
Simple vertical interpolation for 2D tables	V
Simple horizontal interpolation for 1D tables	X
Two-way interpolation using selection corners	C
Two-way interpolation using selection edges	E

Infinity Hot Keys - Configuration

Hot keys can be edited through the Applications Options window located in the [File menu](#) ⁵¹.

Below are some preset Hot Keys for Infinity Tuner.

Action	Default Key
app_options	F2
append_layout	CTRL + P
clear_layout	ALT + SHIFT + C
close_control_window	CTRL + F4
commit_modifications	CTRL + SHIFT + C
connect_usb	CTRL + SHIFT + U
disconnect	CTRL + SHIFT + D
duplicate_control_window	CTRL + F5
goto_live_data	CTRL + G
goto_main_window	ESC
help_about	F1
next_control_window	TAB
next_layout_page	CTRL + TAB
open_layout	CTRL + O
open_session	CTRL + SHIFT + O
prev_control_window	SHIFT + TAB
prev_layout_page	CTRL + SHIFT + TAB
redo	CTRL + Y
revert_modifications	CTRL + SHIFT + R
save_layout	CTRL + S
save_session	CTRL + SHIFT + S

Keys mappings may use ALT, CTRL, and SHIFT.
The names are case insensitive and the "+" separator is optional.

Examples:

next_control_window = "ctrl n"

prev_control_window = "CTRL + P"

Use the "unshifted" key names – for example, to map a command to the "\$" key:

close_control_window = "SHIFT 4"

Table selection and direct math function edits

Any math function can be directly applied to cell selections. In the first image below, a small section of the VE Table is selected using mouse left click and drag or shift + arrow selection.

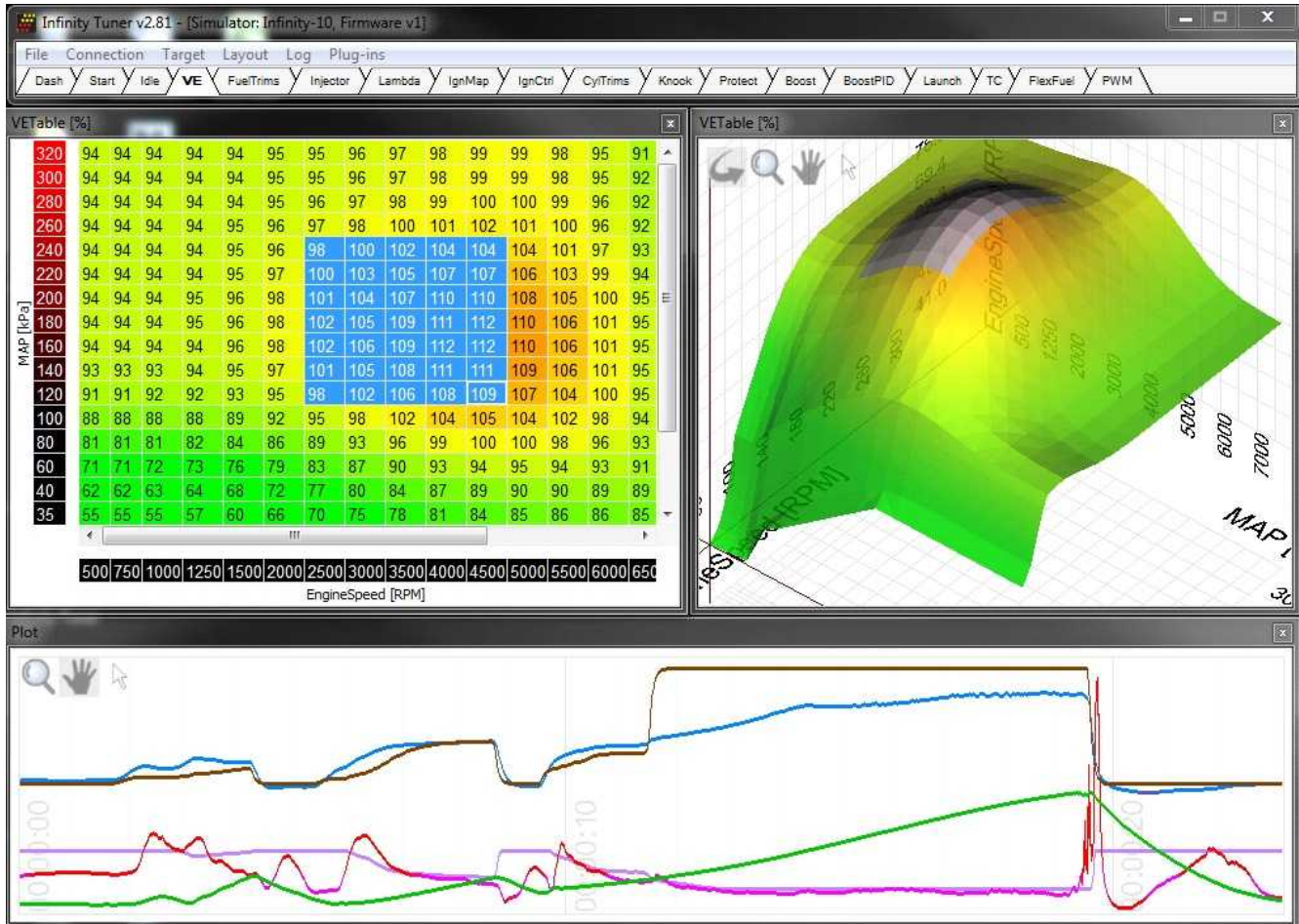

The next image shows a direct math function application typed into the table. This function will be applied to all selected cells. “z” is the current value of the cell “+2” is the applied math function. In this case the result will be adding “2” to the current value of each cell. Any valid math operation can be applied using this method.

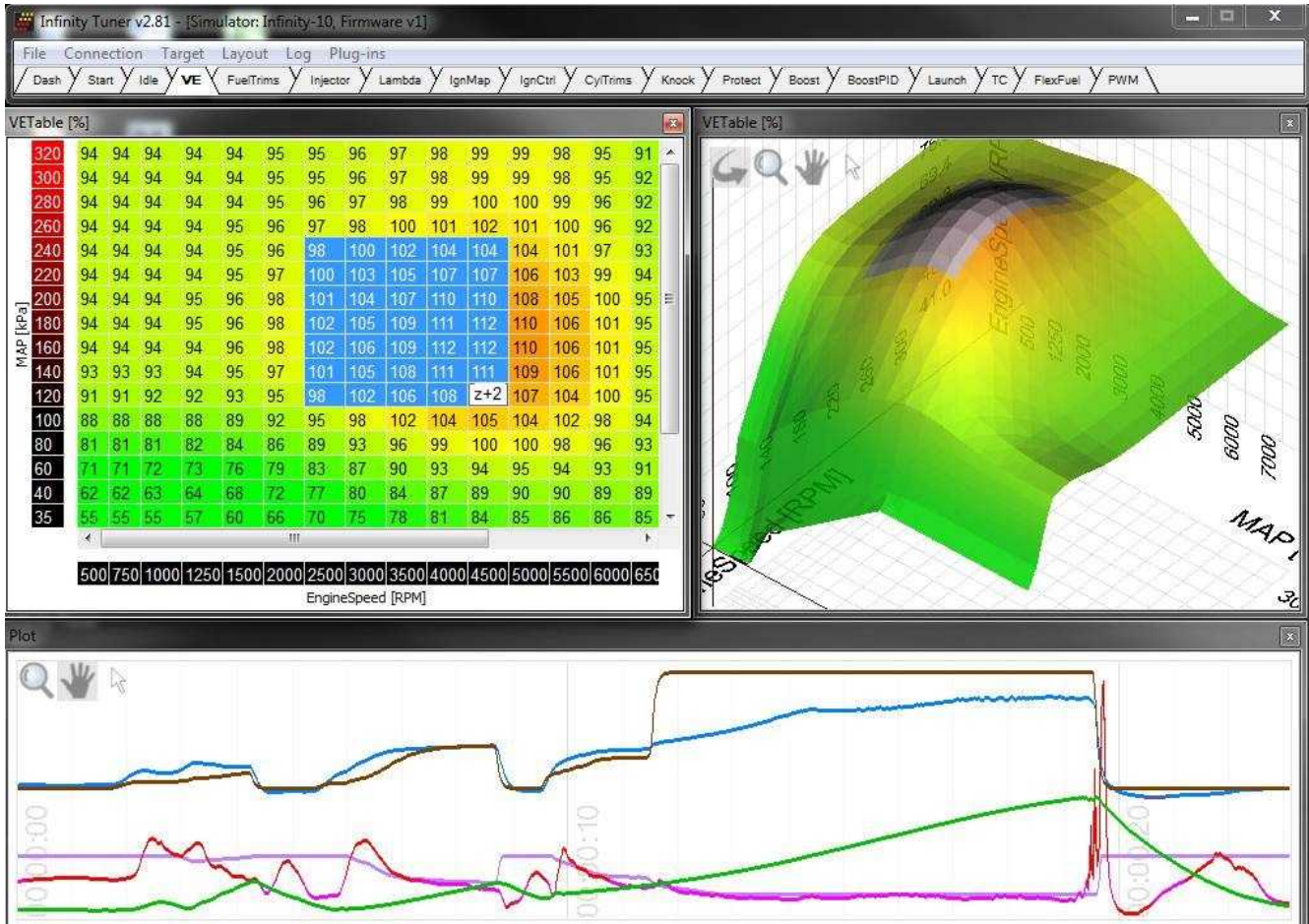

In the Infinity Tuner folder, open the “Keys.ini” in a text editor like notepad. Here you can define shortcut keys used in Infinity Tuner. Simply enter into the text editor.

Action	Default Key
table_math_00	=
table_math_01	-
table_math_02	CTRL + =
table_math_03	CTRL + -
table_math_04	SHIFT + =
table_math_05	SHIFT + -
table_math_06	CTRL + 6
table_math_07	CTRL + 7
table_math_08	CTRL + 8
table_math_09	CTRL + 9
table_math_10	CTRL + 0
table_math_11	CTRL + 1
table_math_12	H
table_math_13	V
table_math_14	C
table_math_15	E
table_math_16	X
table_math_17	CTRL + SHIFT + 7
table_math_18	CTRL + SHIFT + 8
table_math_19	CTRL + SHIFT + 9

*Be sure to save when making changes to the Keys.ini settings. These changes will not take affect until Infinity Tuner is reopened.

When highlighting cells in tables, the user is able to manipulate the data and enter an expression to modify the cells. In the Infinity Tuner folder, open the “Math.ini” in a text editor like notepad. Here you can define various math functions to be used in Infinity Tuner. Simply enter into the text editor:

table_math_xx = desired math expression,
where xx is an integer ranging from 00 to 19

While using Infinity Tuner, these math functions may be used by using the shortcut key you defined for that table_math_xx. The format should be as follows:

// Modify the current cell value(s) by 1%

```
table_math_00 = "z * 1.01"
table_math_01 = "z * 0.99"

// Modify the current cell value(s) by 10%
table_math_02 = "z * 1.1"
table_math_03 = "z * 0.9"

// Modify the current cell value(s) by 5%
table_math_04 = "z * 1.05"
table_math_05 = "z * 0.95"

// Modify the current cell value(s) by 1
table_math_06 = "z + 1"
table_math_07 = "z - 1"

// Modify the current cell value(s) by 10
table_math_08 = "z + 10"
table_math_09 = "z - 10"

// Smoothing using four neighboring cells (left, right, bottom, top)
table_math_10 = "0.8 * z + 0.2 * (cell(ix - 1, iy) + cell(ix + 1, iy) + cell(ix, iy - 1) + cell(ix, iy + 1)) / 4"

// Smoothing using eight neighboring cells
table_math_11 = "0.8 * z + 0.2 * (cell(ix - 1, iy) + cell(ix + 1, iy) + cell(ix, iy - 1) + cell(ix, iy + 1) + cell(ix - 1, iy - 1) + cell(ix + 1, iy + 1) + cell(ix + 1, iy - 1) + cell(ix - 1, iy + 1)) / 8"

// Simple interpolation fill in X direction for 2D Tables
table_math_12 = "cell(sl, iy) * (1 - sx / (sr - sl)) + cell(sr, iy) * (sx / (sr - sl))"

// Simple interpolation fill in Y direction for 2D Tables
table_math_13 = "cell(ix, sb) * (1 - sy / (st - sb)) + cell(ix, st) * (sy / (st - sb))"

// Two-way interpolation fill using only the selection area corners
table_math_14 = "cell(sl, sb) * (1 - sx / (sr - sl)) * (1 - sy / (st - sb)) + cell(sr, sb) * (sx / (sr - sl)) * (1 - sy / (st - sb)) + cell(sl, st) * (1 - sx / (sr - sl)) * (sy / (st - sb)) + cell(sr, st) * (sx / (sr - sl)) * (sy / (st - sb))"

// Two-way interpolation fill using the selection edges
table_math_15 = "(cell(sl, iy) * (1 - sx / (sr - sl)) + cell(sr, iy) * (sx / (sr - sl)) + cell(ix, sb) * (1 - sy / (st - sb)) + cell(ix, st) * (sy / (st - sb))) / 2"

// Simple interpolation fill in X direction for 1D Tables
table_math_16 = "cell(sl, 0) * (1 - sx / (sr - sl)) + cell(sr, 0) * (sx / (sr - sl))"
```

Valid math operators and keywords include the following:

Syntax	Description
pi	3.14159...
e	2.71828...
+	Addition
-	Subtraction
*	Multiplication
/	Division
^	Exponent
%	Modulus
sqrt(a)	Square root
abs(a)	Absolute value
log(a)	Natural log
log10(a)	Log base 10
sin(a)	Sine (a in radians)
cos(a)	Cosine (a in radians)
tan(a)	Tangent (a in radians)
asin(a)	Arc-sine (result in radians)
acos(a)	Arc-cosine (result in radians)
atan(a)	Arc-tangent (result in radians)
floor(a)	Round a down to the nearest integer
ceil(a)	Round a up to the nearest integer
min(a,b)	Smaller of a and b
max(a,b)	Larger of a and b
clamp(a,b,c)	Value of a, clamped between b and c, where $b < c$
For manipulating tables...	
cell(a,b)	The value of the cell at position(a,b)
x	The value on the x-axis at the current position
y	The value on the y-axis at the current position
z	The value of the current cell; same as cell(ix,iy)
i	The index of the current cell in a 1D table or on an axis.
ix	The x-index of the current cell (zero is the left-most column.)
iy	The y-index of the current cell (zero is the bottom-most row.)
w	The width of the current table
h	The height of the current table
sx	The x-index of the current cell relative to the current selection

Syntax	Description
sy	The y-index of the current cell relative to the current selection
sl	The left-most column that is selected
sr	The right-most column that is selected
st	The top-most row that is selected
sb	The bottom-most row that is selected

Below is an example of how table_math_13 is solved.

// Simple interpolation fill in Y direction

```
table_math_13 = "cell(ix, sb) * (1 - sy / (st - sb)) + cell(ix, st) * (sy / (st - sb))"
```

(st - sb) is the number of selected cells minus one. This is just "selection_top minus selection_bottom."
And "sy" will go from zero to that number.

So, (sy / (st - sb)) will be a value that goes from zero to one. It will be zero at the bottom of the selection and one at the top, and some fraction in the middle.

Let's call that value "delta." Now we can rewrite the whole thing as:

```
(cell(ix, sb) * (1 - delta)) + (cell(ix, st) * delta)
```

Those "cell" calls would just give you the cell at the bottom of the selection and the cell at the top of the selection, so it's basically:

```
bottom * (1 - delta) + top * delta
```

The "1 - delta" part will just be the opposite of delta. As delta goes from zero to one, "1 - delta" will go from one to zero.

The end result is all the cells between top and bottom will be some combination of top and bottom, based on that "delta" value. This is a pretty standard way to do what is called "linear interpolation."

The "table_math_14" expression is a 2D version of the same thing. It has a "delta" in the X direction and another "delta" in the Y direction. Every cell inside the selection would be some combination of the four corners weighted by those two deltas.

Hardware

Serial Number



All Infinity ECUs are serialized. Be sure this identification tag stays intact. Write the number down to be safe. Infinity ECUs are programmed with cryptographically secure firmware files and each ECU has a unique file set. The serial number is used to identify the correct files for your ECU.

Account Registration

Note: Hardware part numbers shown in the screen shots below are examples only. Refer to your individual ECU part number and serial number when filling out registration information.

- 1) Go to <http://www.aeminfinity.com> and click on the "Register Here" button.

www.aeminfinity.com

AEM
PERFORMANCE ELECTRONICS

INFINITY
AEM

Your Account

User Name:

Password:

Remember me?

Log In

[Forgot Password?](#)

Don't have an account?

Register Here

Welcome to...
AEMInfinity.com

ECU Registration

Infinity Product News:
August 20, 2012
[CLICK HERE for an overview of the Infinity EMS.](#)

2) Enter required information and click the “Register” button.

AEM
PERFORMANCE ELECTRONICS

Your Account

[Log On]

welcome to ...
AEMInfinity.com

Create a New Account

Use the form below to create a new account.
Passwords are required to be a minimum of 6 characters in length.

Account Information

Email address

Password

Confirm password

Are you an AEM Tuner?
 Yes, I am an AEM Tuner

Register

A confirmation email will be sent to the supplied email address. Choose one of the following options:

- Click on the “click here” link.
- Or, copy the code and enter it into the Confirmation Code Box.

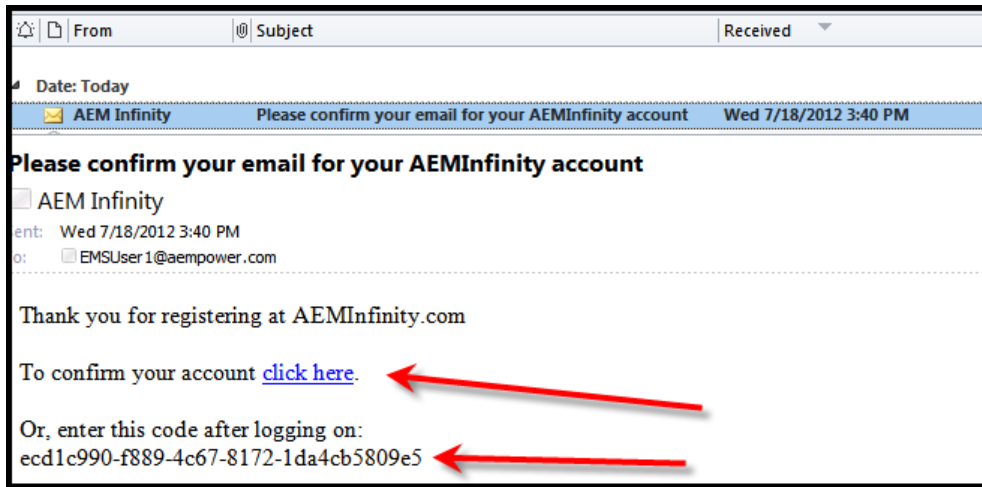

3) After entering the code, click on the “Confirm” button.

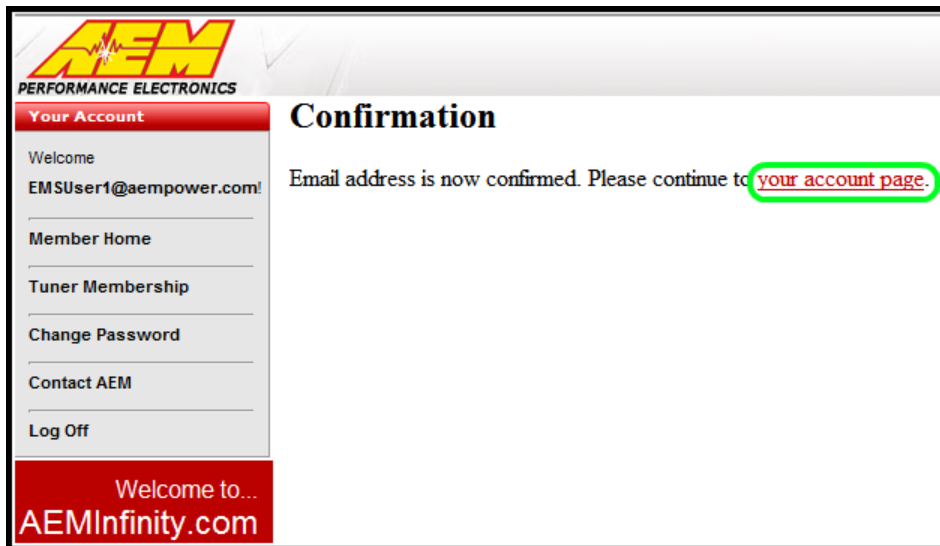

4) Click on the “your account page” to continue with ECU registration; otherwise click the “Log Off” button.

AEM Infinity ECU Registration

1) Go to <http://www.aeminfinity.com> and log in to your account.

AEM Electronics - AEM Infr x Catalog & Software Downlo x

www.aeminfinity.com

AEM PERFORMANCE ELECTRONICS

INFINITY AEM

Your Account

User Name:
EMSUser1@aempower.com

Password:

Remember me?

Log In

Forgot Password?

Don't have an account?

Register Here

Welcome to...
AEMInfinity.com

ECU Registration

Infinity Product News:

August 20, 2012

[CLICK HERE for an overview of the Infinity EMS.](#)

2) Click on the "Register New Product" button.

AEM PERFORMANCE ELECTRONICS

INFINITY AEM

Your Account

Welcome
EMSUser1@aempower.com!

Member Home

Tuner Membership

Change Password

Contact AEM

Log Off

Welcome to...
AEMInfinity.com

Home

Register New Product

Your Products:

AEM **Infinity Engine Management System**

Serial Number	Used For	Activated	More Info
No Products Registered			

Firmware That Has Been Updated Since You Downloaded It

Serial Number	Firmware	Download Date	Downloaded Firmware Date	Current Firmware Date
No Firmware Updates				

3) Enter the Serial Number and Security Code. Serial Number is found on sticker on ECU case. Security Code is included in ECU packaging.

Product Registration

Register

Serial Number:

Example: XXXX-XXXX

Security Code:

Example: XXXXXXXX

Register

- 4) Enter Product Registration Information. You must first read and accept the Agreement before completing registration.

Add Product

Serial Number: 7100-9991
Status: Ready To Register

Your Information

* Address:

Address (Line 2):

* Zip Code:

* City:

* State:

* Country:

* Phone Number:

Product Usage

Vehicle Information:

*Make:

*Model:

*Year:

Register

*Usage Agreement:

[Click Here to View Agreement](#)

Complete Registration



* Required Fields

- 5) Read and then accept Usage Agreement by selecting the "I Agree" button.

Usage Agreement ✕

I/We understand, acknowledge and agree that in the United States the Environmental Protection Agency ("EPA") regulates the use of AEM Infinity Engine Management Systems ("Systems") under the Clean Air Act, and in accordance with the EPA's rules and regulations the Systems are only authorized for installation and use in vehicles which are exclusively used for sanctioned competition and that use of the Systems by vehicles driven on U.S. public roads, streets and highways is strictly prohibited.

6) Click the "Complete Registration" button once the Usage Agreement has been accepted.



Your Account
Welcome
EMSUser1@aempower.com!
Member Home
Tuner Membership
Change Password
Contact AEM
Log Off
Welcome to...
AEMInfinity.com

Add Product

Serial Number	7100-9991
Status:	Ready To Register

Your Information
* Address:

Address (Line 2):

* Zip Code:

* City:

* State:

* Country:

* Phone Number:

Product Usage
Vehicle Information:
*Make:
*Model:
*Year:

Register
*Usage Agreement:
Agreed 10/02/2012

* Required Fields

Firmware and Configuration Updates

1) Go to <http://www.aeminfinity.com> and log in to your account.



2) Locate Firmware and Configuration updates. Check for Firmware Updates since last downloaded. Click the "INFO" button to locate Firmware and Configuration files.

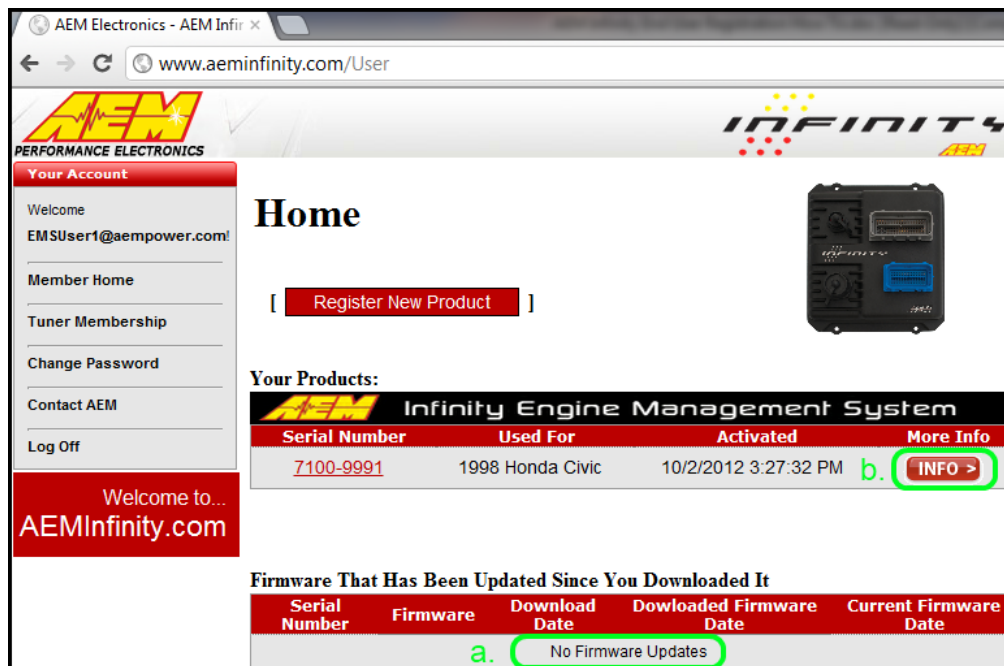

3) Locate the desired Configuration file and click the "Download" button. The Configuration file includes the Firmware and the Configuration files as a .pakgrp file.

Available Software:

 Infinity Engine Management System		
File	Configuration	Created
Download	v96.1 Inf-10 Universal	5/20/2015 2:49:43 PM
Download	v96.1 Inf-10 Semi-Seq	5/20/2015 2:49:43 PM
Download	v96.1 Inf-10 Ford Coyote	5/20/2015 2:49:42 PM
Download	v96.1 Inf-10 Diagnostics	5/20/2015 2:49:42 PM
Download	pre-v96.1 Legacy Peripheral Firmware	5/20/2015 2:49:42 PM
Download	Infinity-10 Ford Coyote V96	11/10/2014 2:59:49 PM
Download	Infinity-10 Semi-Sequential V96	11/10/2014 2:19:05 PM
Download	Infinity-10 Output Diagnostic V96	11/10/2014 2:19:05 PM
Download	Infinity-10 Universal V96	11/10/2014 2:19:05 PM

4) Save the .pakgrp file in the AEM Infinity Tuner directory: C:/Program Files (x86)/AEM/Infinity Tuner

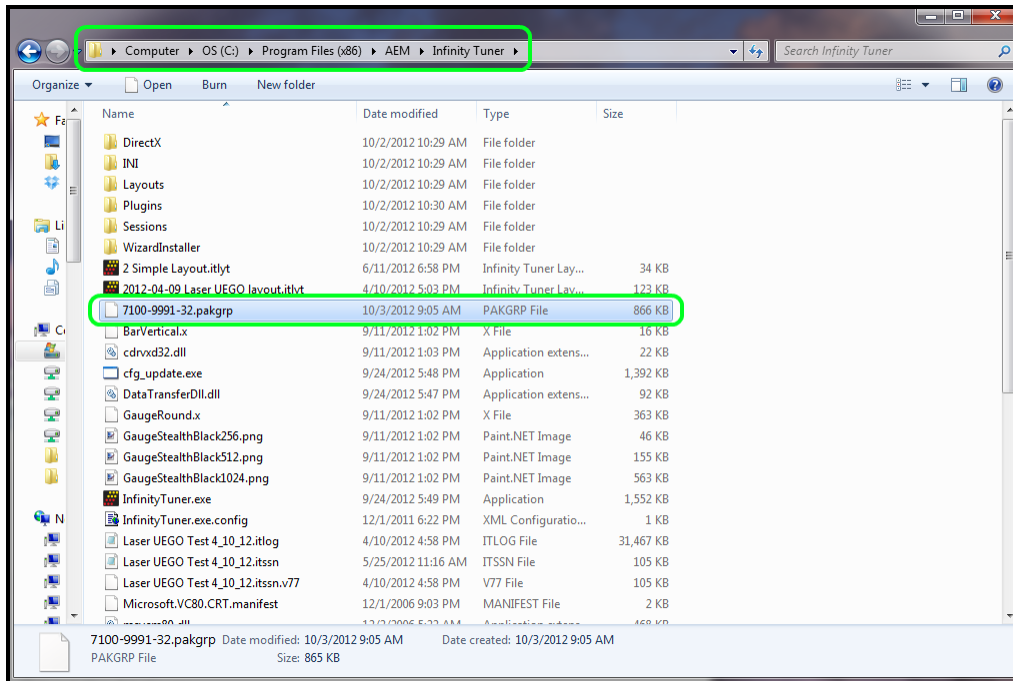

aeminfinity.com file descriptions

Description of files available on aeminfinity.com

The following example shows a typical list of available files on aeminfinity.com. This particular examples shows files available for an Infinity-10 ECU (part number 30-7100).

Available Software:

File	Configuration	Created
Download	v96.1 Inf-10 Universal	5/20/2015 2:49:43 PM
Download	v96.1 Inf-10 Semi-Seq	5/20/2015 2:49:43 PM
Download	v96.1 Inf-10 Ford Coyote	5/20/2015 2:49:42 PM
Download	v96.1 Inf-10 Diagnostics	5/20/2015 2:49:42 PM
Download	pre-v96.1 Legacy Peripheral Firmware	5/20/2015 2:49:42 PM
Download	Infinity-10 Ford Coyote V96	11/10/2014 2:59:49 PM
Download	Infinity-10 Semi-Sequential V96	11/10/2014 2:19:05 PM
Download	Infinity-10 Output Diagnostic V96	11/10/2014 2:19:05 PM
Download	Infinity-10 Universal V96	11/10/2014 2:19:05 PM

v96.1 files (the latest version)

Peripheral Micro firmware compatible with older versions

Old v96 files

The files listed in the top highlighted box are the latest files with all latest features available for this hardware

platform. There are four options.

1. v96.1 Inf-10 Universal - A universal pakgrp file that will work on a wide variety of different sequentially injected applications supporting up to 10 injectors and 10 coil outputs.
2. v96.1 Inf-10 Semi Seq - Same universal above but able to support semi-sequential injection setups with no cam sync
3. v96.1 Inf-10 Ford Coyote - Same as universal above but able to support certain unique hardware I/O requirements of the Ford Coyote engine
4. v96.1 Inf-10 Diagnostics - Unique model designed to provide custom diagnostics features for the Infinity-10 ECU.

The file listed in the second highlighted box is new peripheral microcontroller firmware that is only necessary if reverting to older firmware versions after upgrading to v96.1.

The files listed on the third highlighted box are older files still available for download for this hardware platform. They do not have the latest features.

Firmware Update Window Layout

Firmware update window layout and definitions

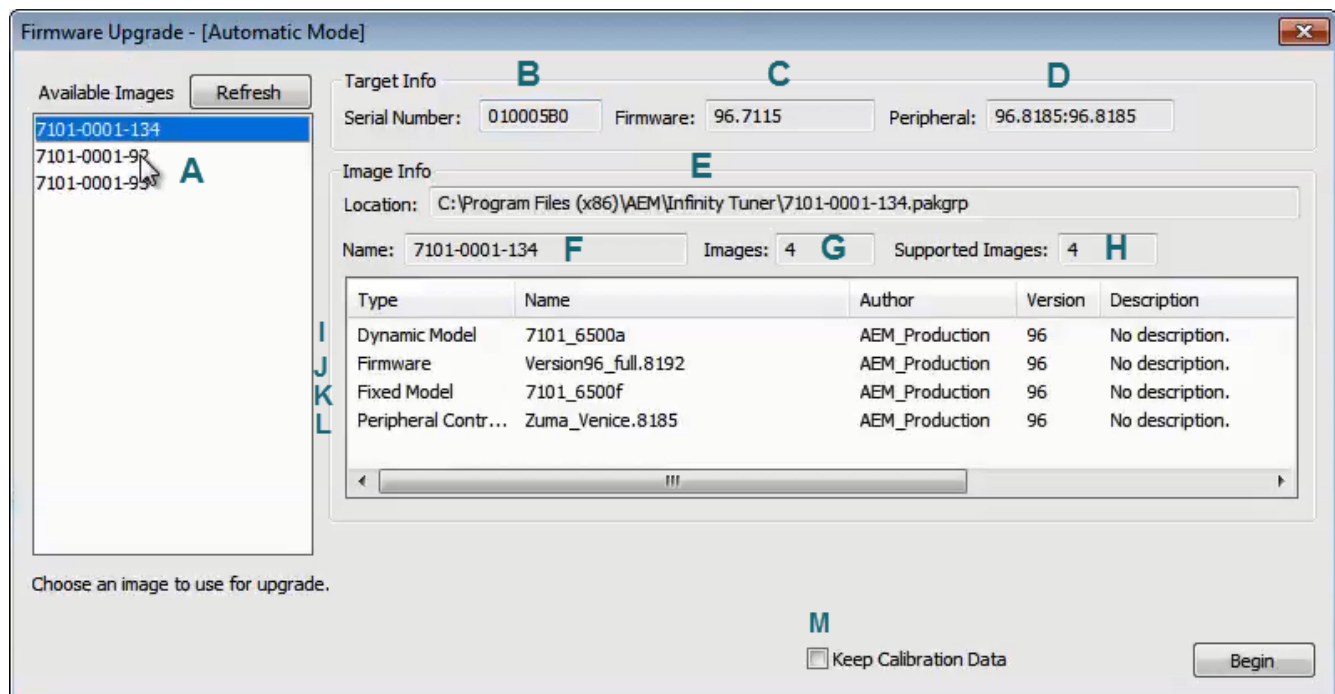

(A) - Available Images

A list of configuration (pakgrp) files compatible with a particular ECU. Each Infinity ECU is unique. Pakgrp files from one Infinity ECU can not be used on another Infinity ECU. Several pakgrp files are usually available for each Infinity hardware part number. Selecting one of the items in this list will populate the Image Info window with the descriptions of all files contained in the pakgrp. **Appropriate files for your application must be downloaded from aeminfinity.com and saved on your PC in order to appear in this list..**

(B) - Serial Number

This is a unique hardware identifier number for the ECU. Although they are related, it is not the same as the ECU serial number included on the serial number sticker.

(C) - Firmware

The version of the firmware on the primary microcontroller in the Infinity ECU. This is not necessarily the version of the firmware being loaded into the ECU. It is the version being upgraded from. In the example image above, the firmware version currently loaded on the ECU is 96.7115. The version being loaded into the ECU is 96.8192.

(D) - Peripheral

The Infinity ECU includes two different microcontrollers that require firmware. This is the version of the firmware loaded into the peripheral microcontroller.

(E) - Location

The directory location of the selected pakgrp file

(F) - Name

The file name of the selected pakgrp file

(G) - Images

The number of files or "images" contained within the selected pakgrp file

(H) - Supported Images

The number of valid supported images contained within the selected pakgrp file

(I) - Dynamic Model

Infinity control model files are typically broken into two parts. The dynamic model file primarily contains tuning table data and calibration constants.

(J) - Firmware

The firmware for the primary microcontroller contained within the pakgrp file. This is the version being upgraded to.

(K) - Fixed Model

Infinity control model files are typically broken into two parts. The fixed model file primarily contains control logic math expressions and non-modifiable tuning constants.

(L) - Peripheral Controller

The firmware for the peripheral microcontroller contained within the pakgrp file. This is the version being upgraded to.

(M) - Keep Calibration Data

Select to keep the existing calibration data and import it into the new configuration during the upgrade process.

Pakgrp files are available to registered Infinity users at aeminfinity.com. You must download and save your pakgrp file before proceeding with the firmware update process below.

Firmware Update

BEFORE beginning the update process, be sure to have a saved copy of your tuned session file. If a power failure occurs during the update process, this is the only way to ensure that the calibration data is not lost. A power failure at certain critical points in this process could render the ECU inoperative, requiring return and repair at AEM. Ensure the PC has a full battery charge and/or is connected to AC power. This process can take UP TO 4 MINUTES to complete, especially if the peripheral microcontroller is updated at the same time.

If the firmware version on the ECU is older than the version supported by your current version of Infinity Tuner, a firmware upgrade will be required when you connect. Otherwise, follow the procedure outlined below.

Note: The firmware update utility is periodically revised and may not match the descriptions below. In the event of a conflict, please follow the instructions provided in the dialog windows themselves or supplemental instructions provided by AEM.

- 1) Connect to Infinity Tuner.
 - a. Plug the USB cable from the ECU into your computer USB port and key ignition ON.
 - b. Open Infinity Tuner.
- 2) Click the Target drop-down list and select “Upgrade firmware...”

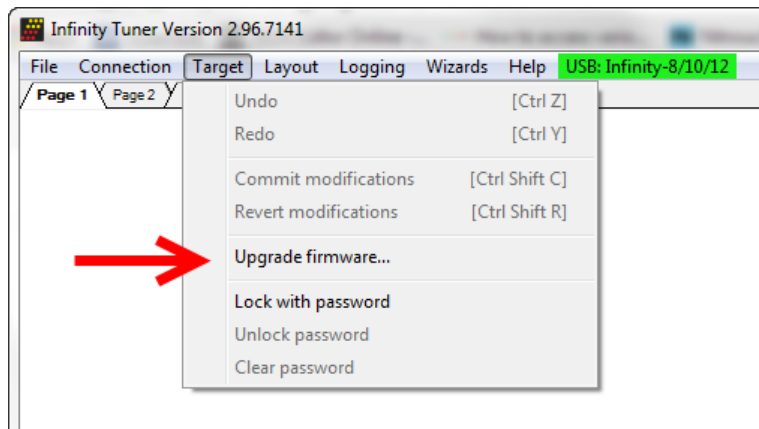

- 3) The ECU should not be running an engine at this time. Select “Yes” when the warning message appears.

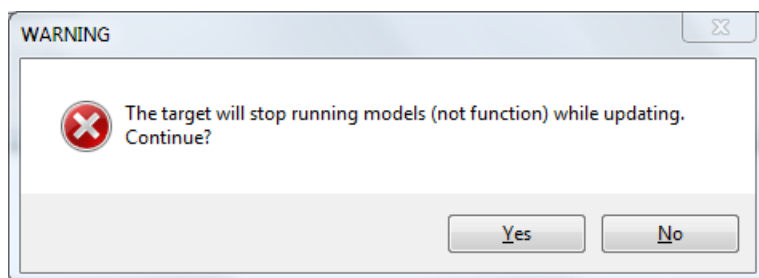

Begin the Firmware Upgrade process.

- a. Select the desired Configuration “Image” on the left.

- i. If no images are present check C:\Program Files (x86)\AEM\Infinity Tuner\ and verify .pakgrp file is there. If not, visit <http://www.aeminfinity.com>, log in, and download appropriate file.
- b. Ensure "Keep Calibration Data" check-box is marked to save current calibration.
- c. Click the "Begin" button to start the upgrade process.

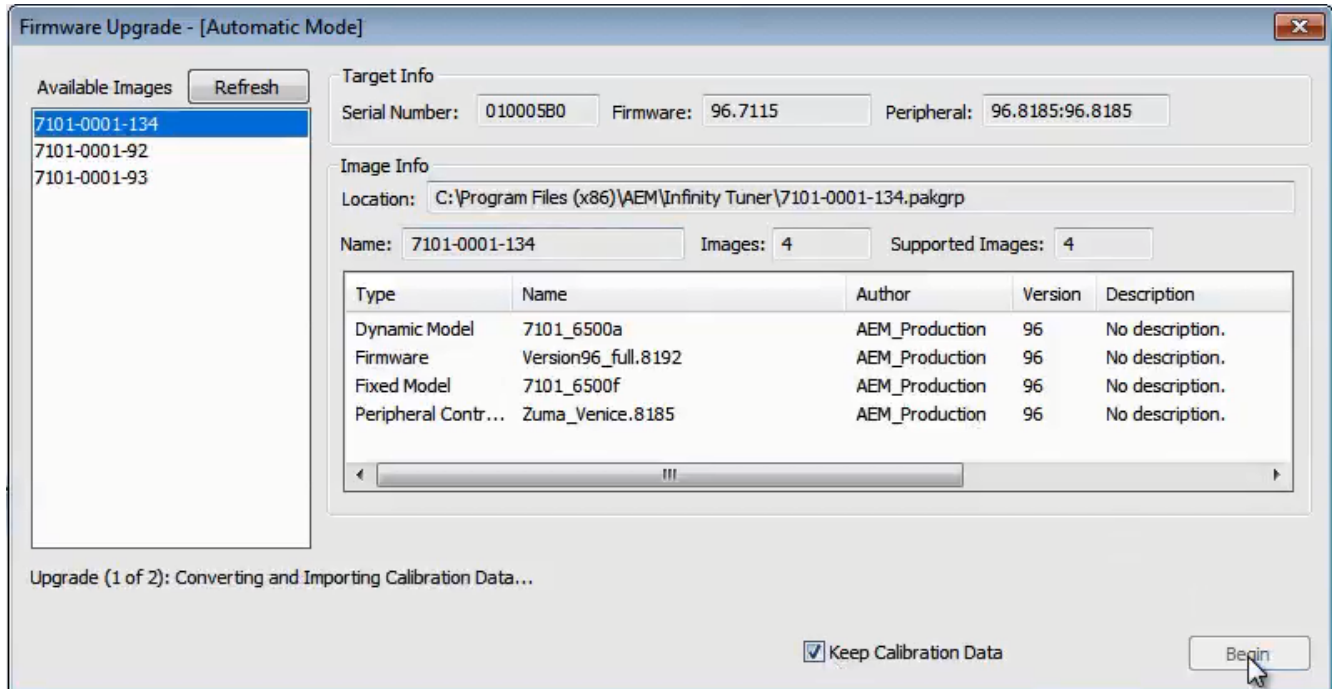

- 4) Follow the message at the bottom, and turn the ignition switch OFF when instructed to do so.

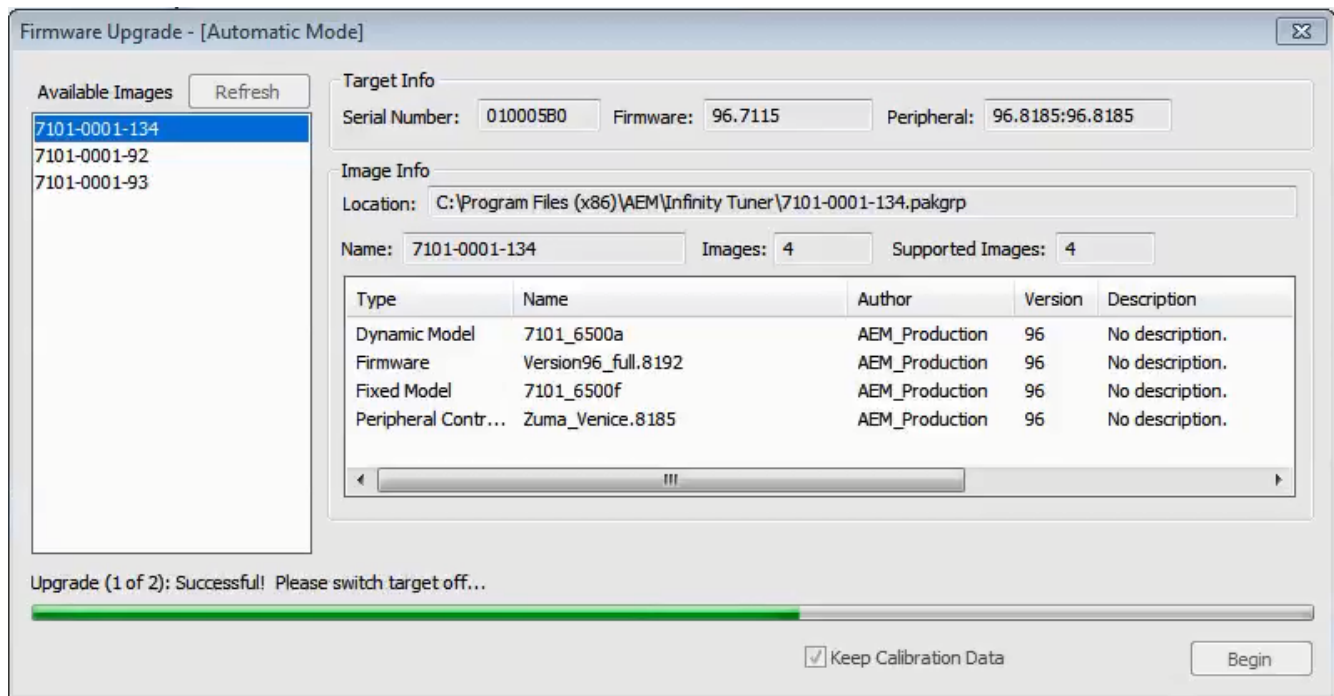

5) Follow the message at the bottom, and turn the ignition switch back ON when instructed to do so.

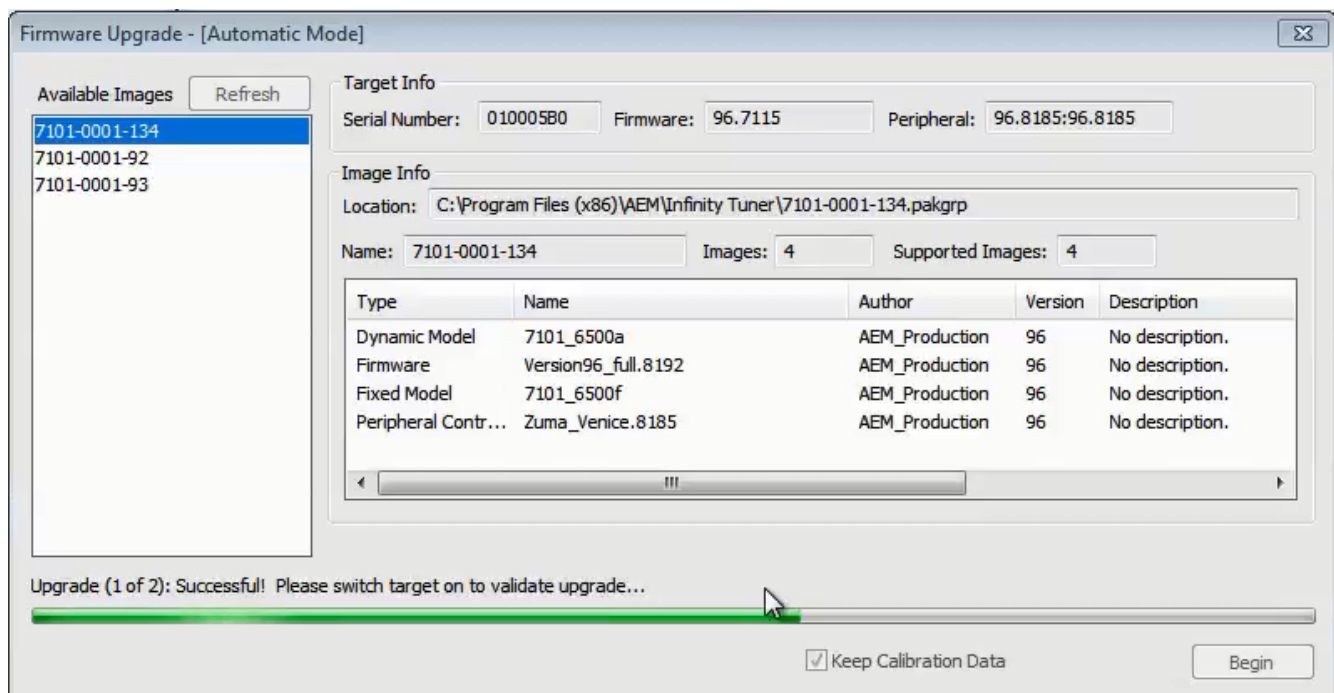

If Keep Calibration Data is checked, the system will upgrade and load all usable calibration data as shown below.

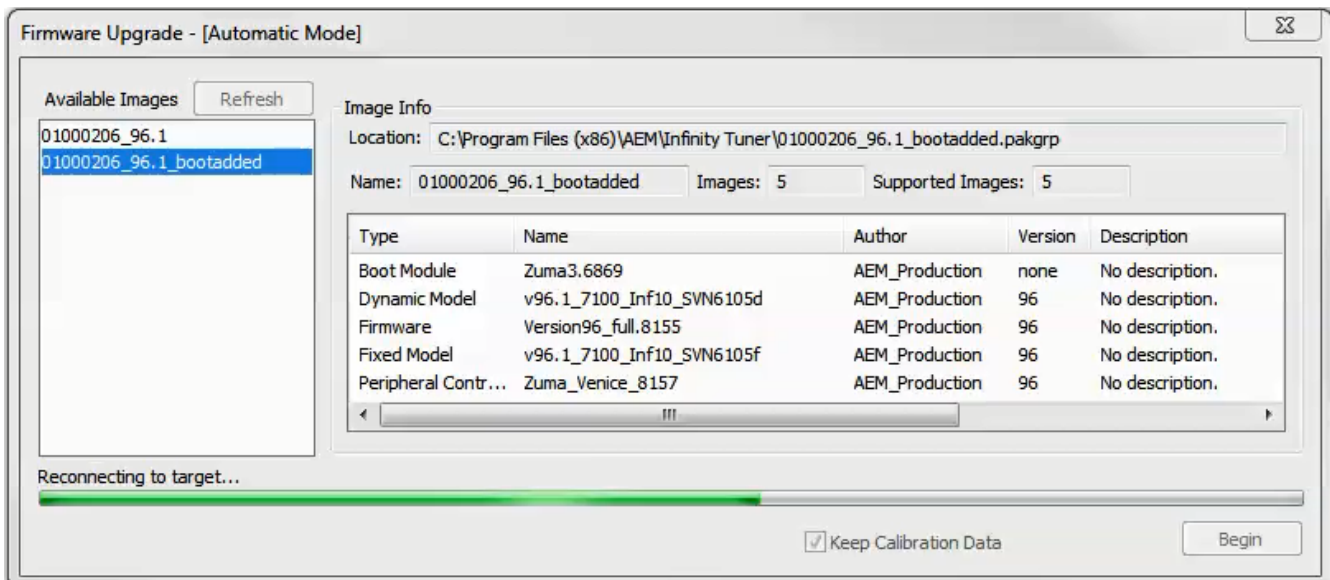
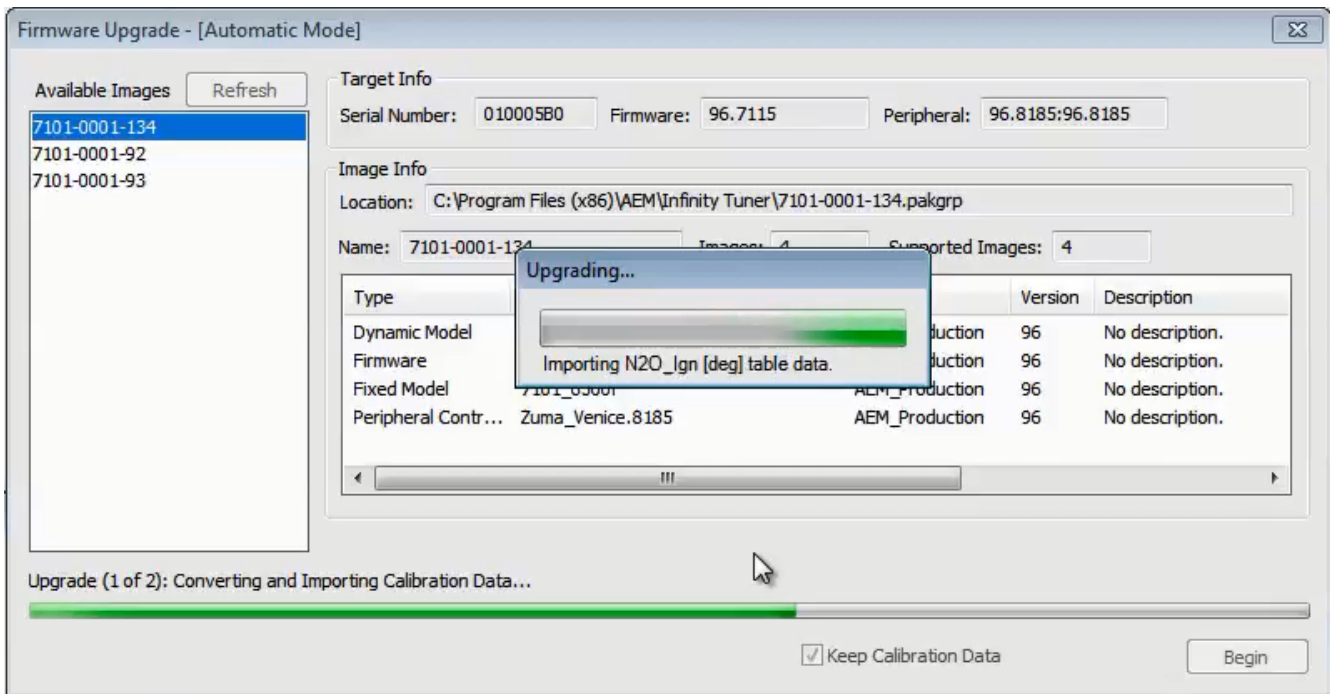

Note: at certain points in the process, the Infinity ECU will re-boot and attempt to connect with the PC. The time it takes to connect might vary for different PCs. If the process appears to hang at this stage, simply unplug and replug the USB comms connector. Often this will force the PC to re-enumerate the USB port and connect.

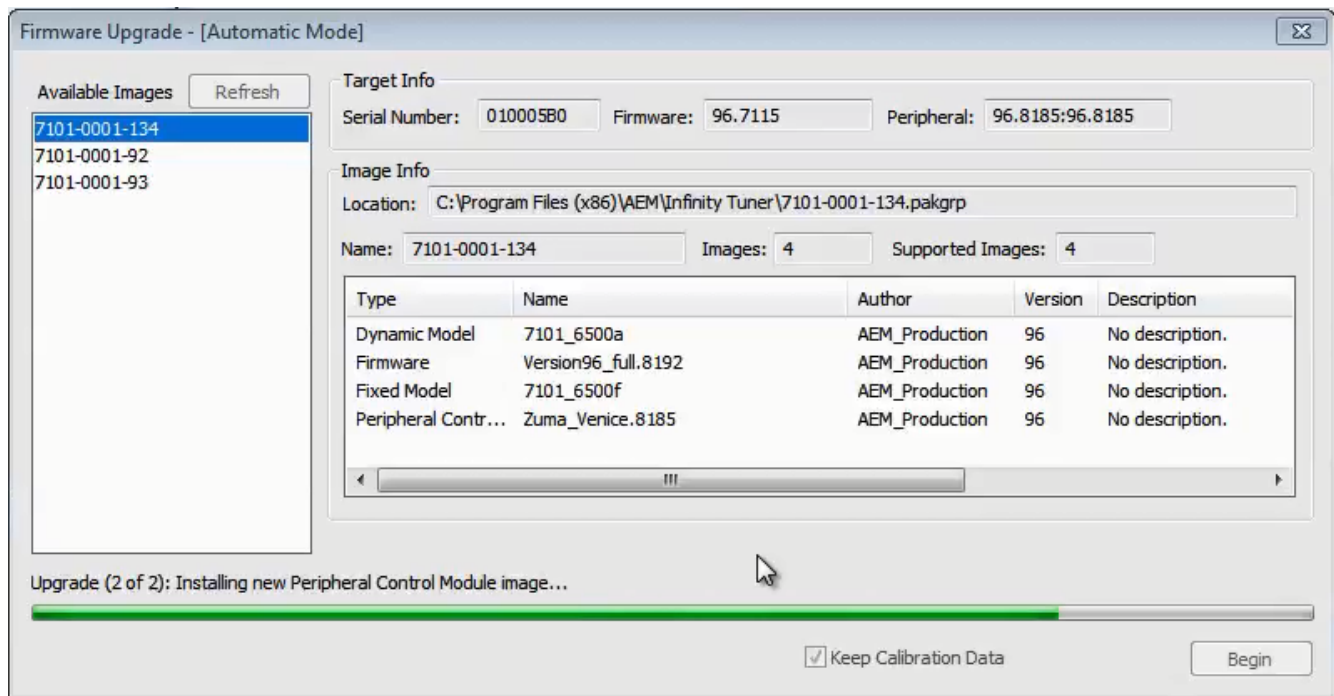

6. When the "Peripheral Control Module image" is updated, a full power reset may be required meaning either the battery needs to be disconnected and re-connected or all harness connectors need to be removed from the ECU for at least 5 seconds, then re-connected.

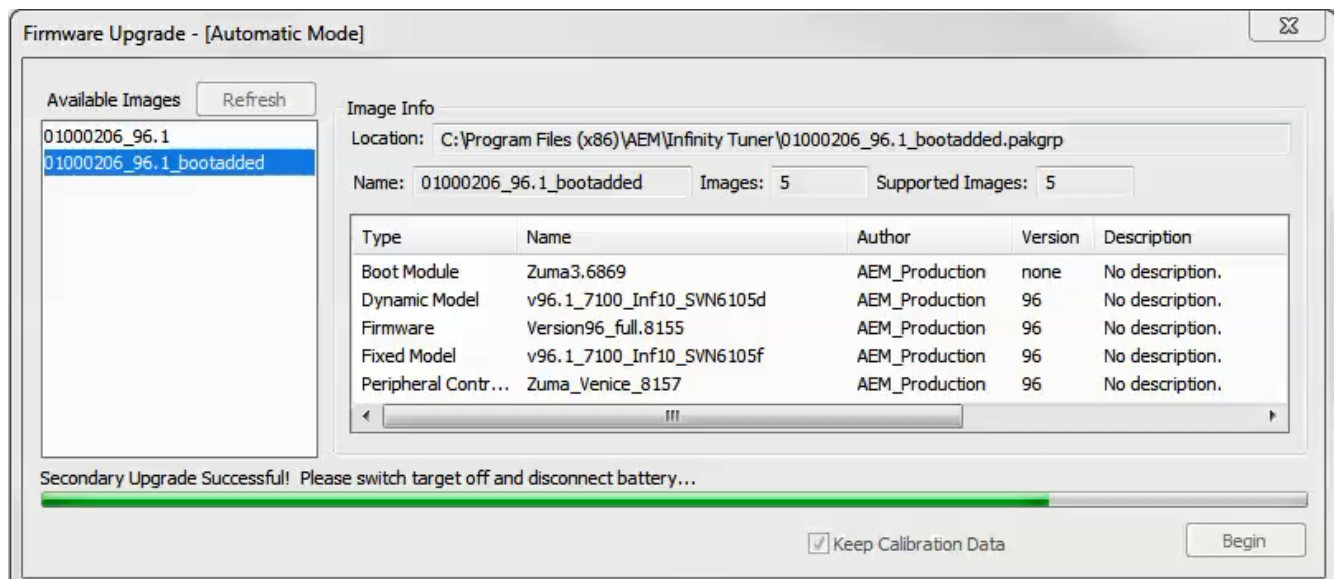

7. When the message below is displayed, turn the ignition switch back on.

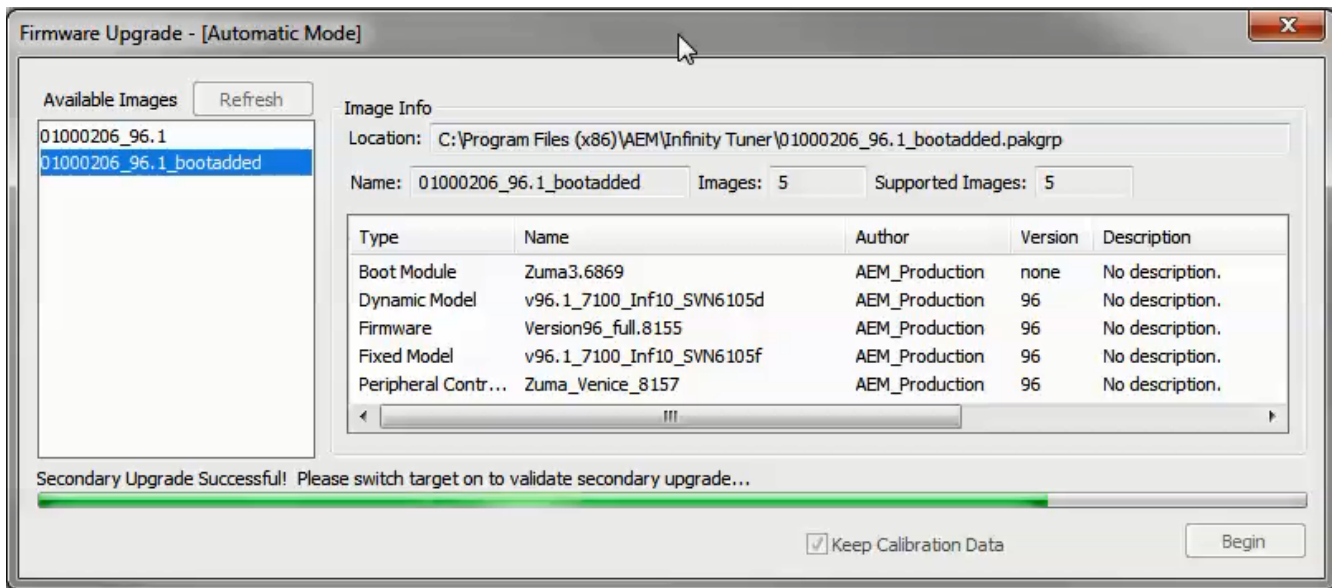

8. When the message at the bottom indicates that it's safe to close the window, click "X" button on the top right of the window.

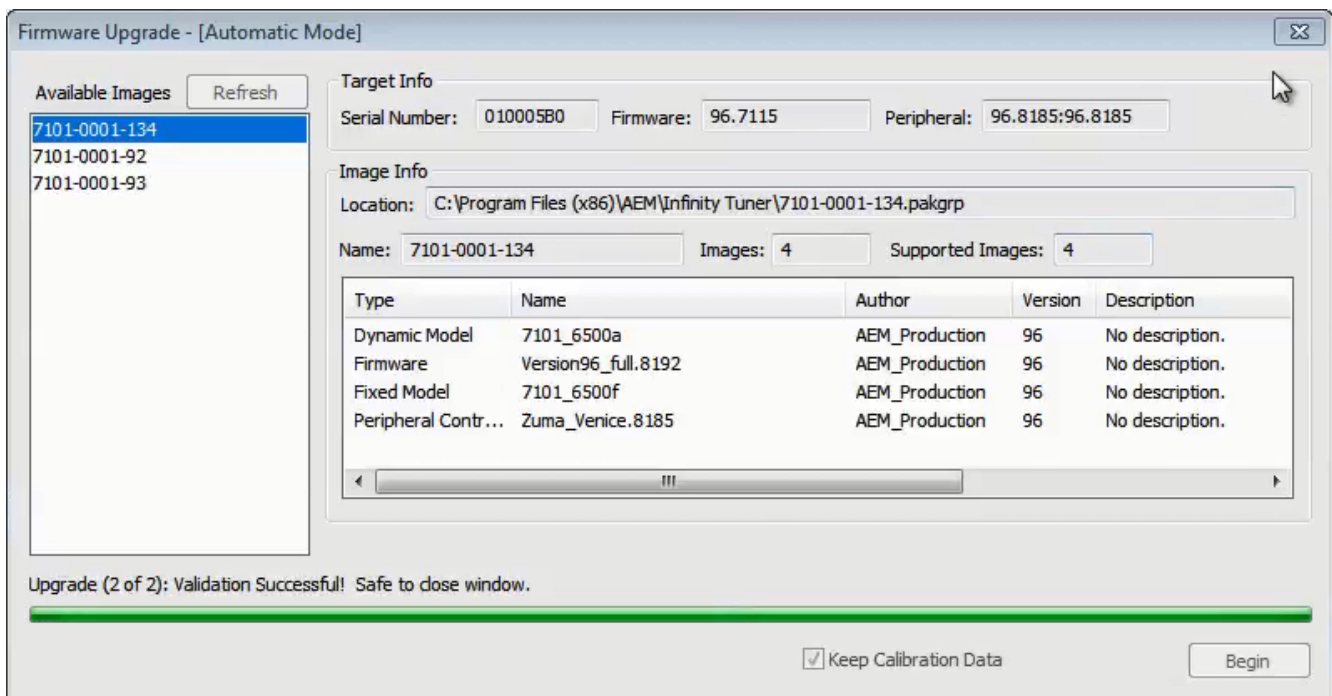

Once the update is complete, it's good practice to cycle the ignition switch to reset the hardware. Once that is done, you can connect and begin monitoring data and/or tuning again. **For applications that use a stepper motor idle valve, it's important that a full power reset be done prior to starting the engine. Turn the key off and wait at least 20 seconds before starting. This will allow the stepper valve to park and reset.**

A firmware update will erase the USB log channel list stored in the ECU memory. This channel list will need to be reset before USB logging will function correctly. Go to Logging>USB Logging – Channel Setup. This dialog allows the user to select channels for USB logging. Manually select channels by left clicking

on the check box or alternately by using the arrow keys to scroll through the list and the space bar key to select. Logging lists can be saved for later use by using the Save button. The Load button will load previously saved lists of channels. The Append button will append a different list of channels onto the existing list of selected channels. Note that the list of channels for logging is saved in ECU memory. Channels can't be selected offline. They can only be selected when connected to an ECU.

Firmware Update Troubleshooting

Troubleshooting

If the process hangs at any point, wait at least one minute for it to continue. Some PCs take longer to reconnect to the ECU during this process. Some PCs may have other processes running that affect the response time of the USB ports. If the process has not continued as described above after one minute, do not cycle key power. Instead, remove the USB cable from the PC, wait a few seconds then plug it back in. Often this will force the OS to reset the port allowing the process to continue.

"Upgrade Failure! Could not delete Power control Module image!"

If this message is displayed during the update process, be sure you have the latest Infinity Tuner software installed. It should be version 2.96.8202 or later. Once you have the right Infinity Tuner software installed, the following procedure must be followed to recover the ECU.

- 1) Disconnect all power from the ECU, including battery power and ignition switch power. Connect the ECU's flash enable pin to 12V (see your hardware pinout for details). All Infinity harnesses supplied by AEM come equipped with a "flash enable" jumper.
- 2) Connect and flash your old v96 pakgrp into the ECU.
- 3) After flashing the (v96 old version) into the ECU, disconnect the flash enable pin, power down the ECU.
- 4) Remove the flash enable connector
- 5) Power up the ECU and flash the legacy peripheral microcontroller file.
- 6) After all steps above are complete, you should be able to flash your new v96.1 file.

Loading firmware files older than v96.1 after upgrading to v96.1

AEM does not recommend reverting to older pakgrp files after updating to v96.1. In the unlikely event that an old firmware version must be loaded after upgrading to v96.1, the following two step procedure must be followed

Step 1 - Load Legacy Peripheral Microcontroller firmware

This pakgrp file, available at aeminfinity.com for each Infinity ECU contains only one file, the legacy peripheral microcontroller firmware.

- 1) Go to Target>Upgrade firmware...

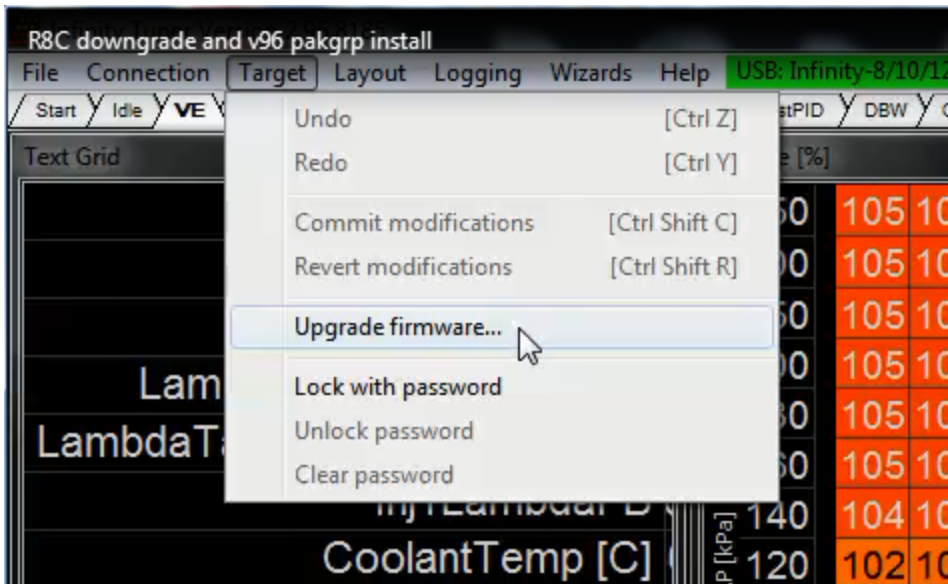

- 2) Select the new Peripheral Legacy pakgrp from the list of available images. Note that it only contains one file. Do not check the Keep Calibration Data checkbox.

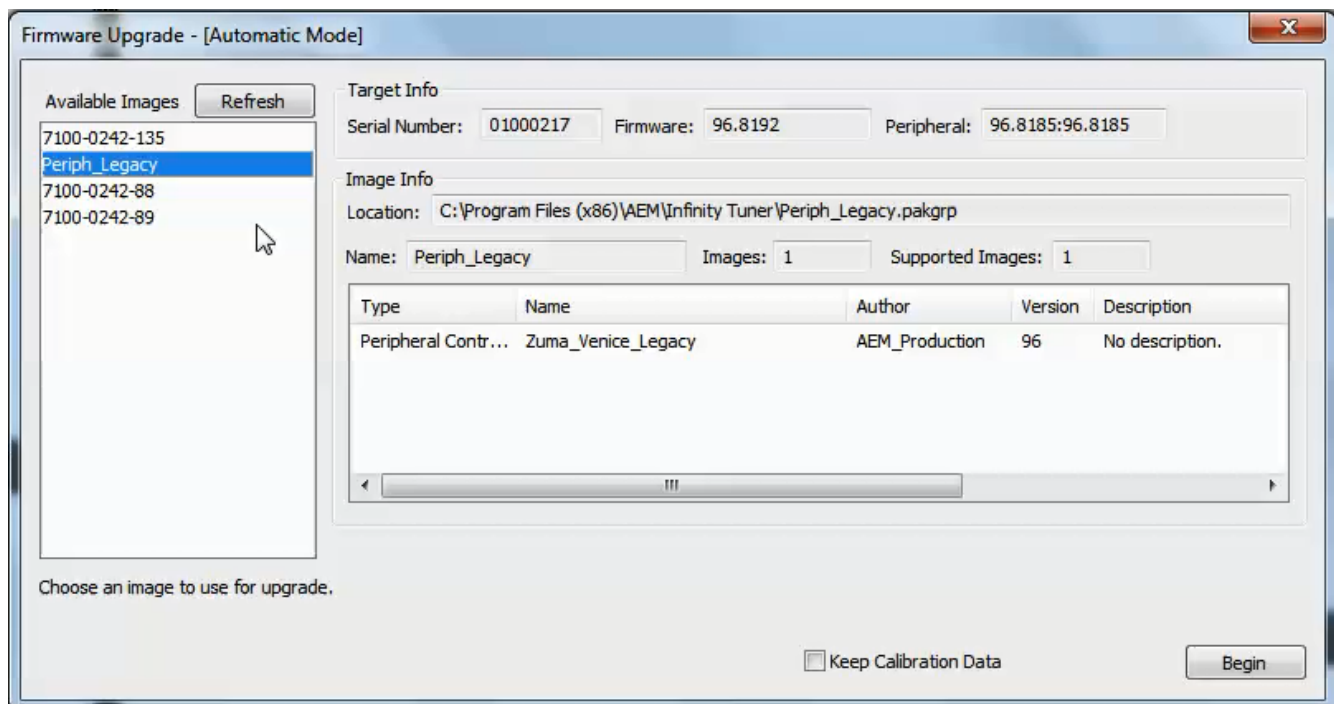

- 3) Click Begin and follow the displayed instructions. The first step is to turn the ignition switch OFF.

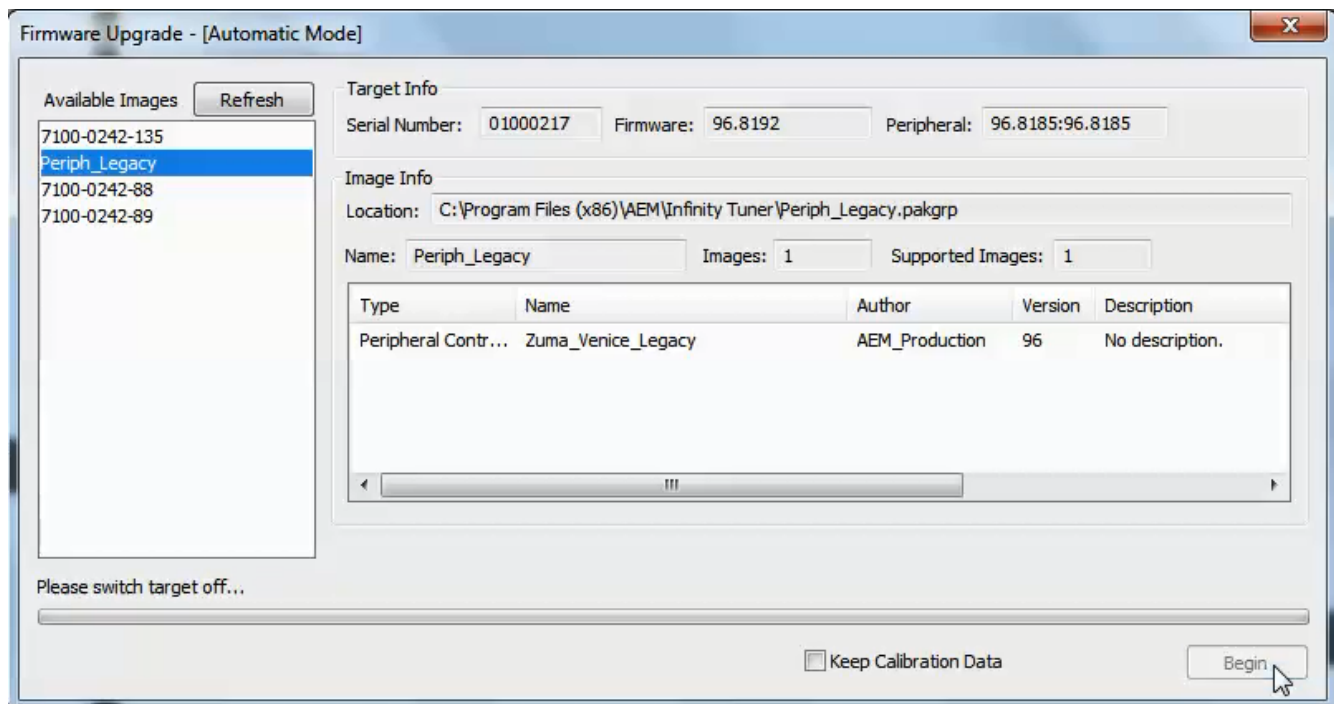

4) Turn the ignition switch back on when instructed to do so.

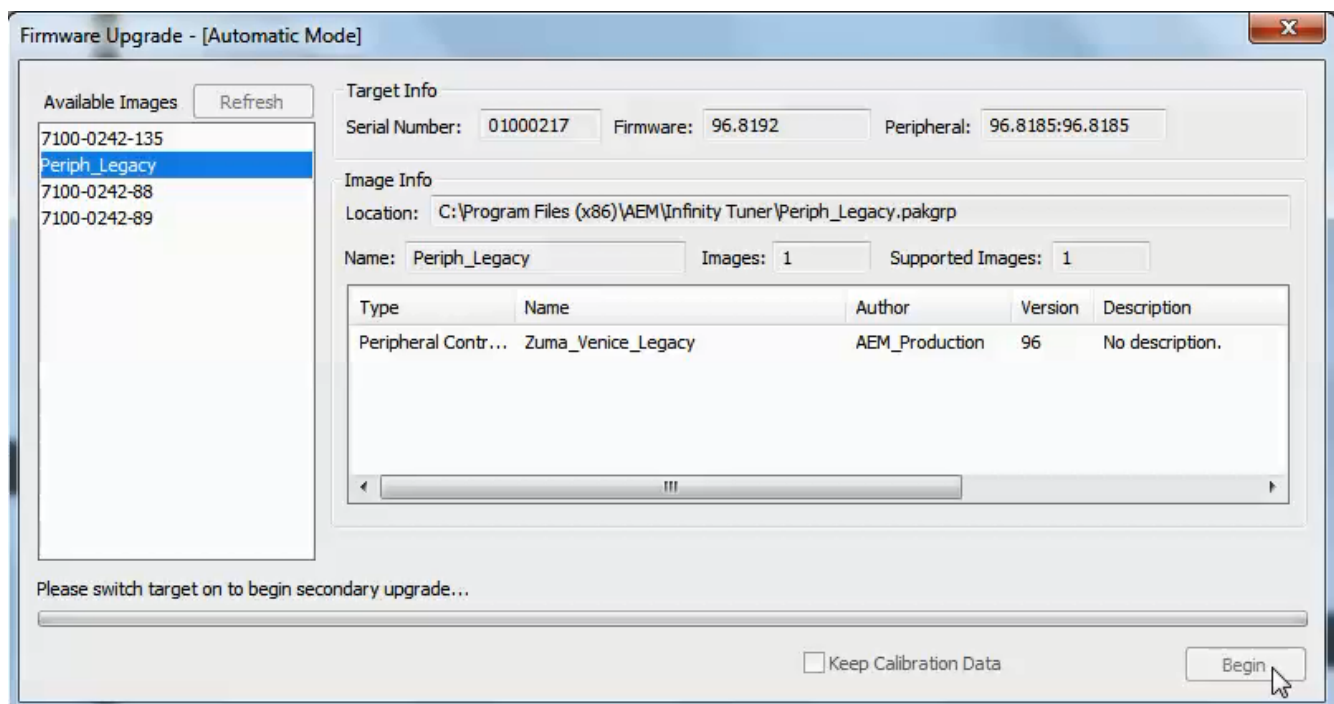

5) The new peripheral microcontroller firmware image will now be loaded.

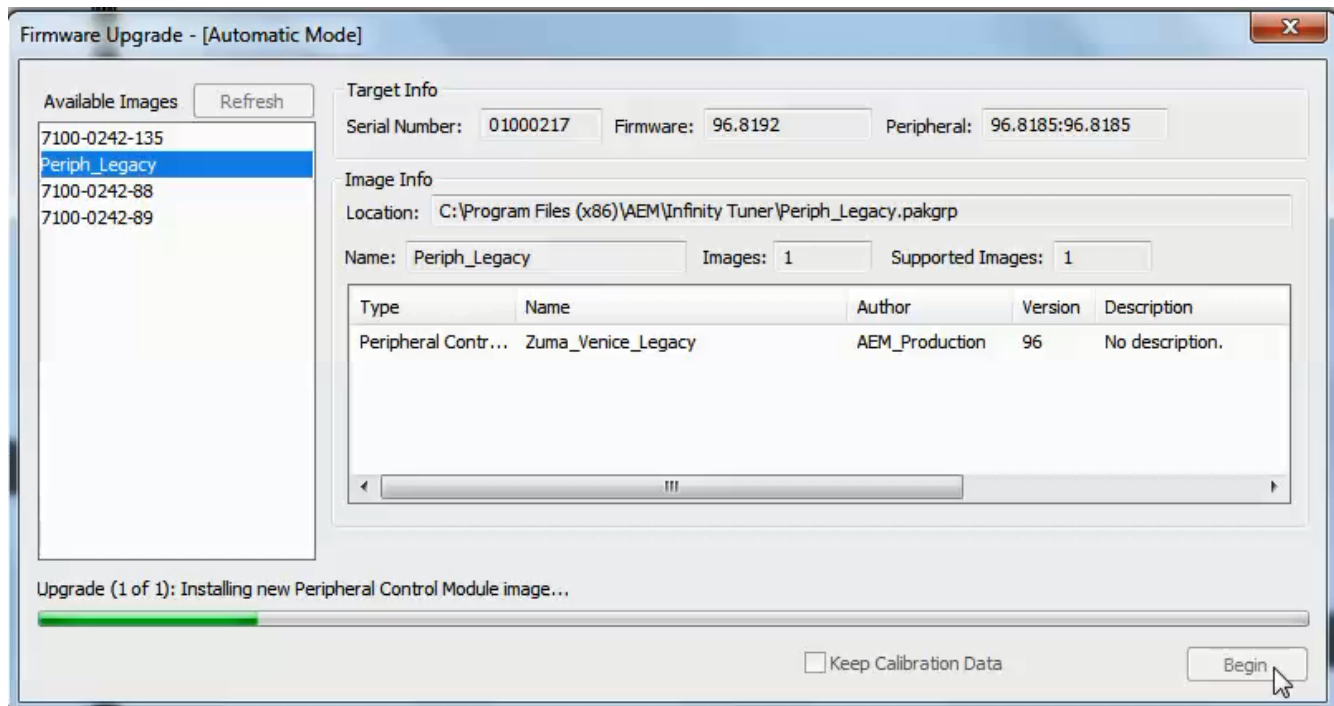

6) The following window indicates that the file was loaded successfully. Click the red X to close the window.

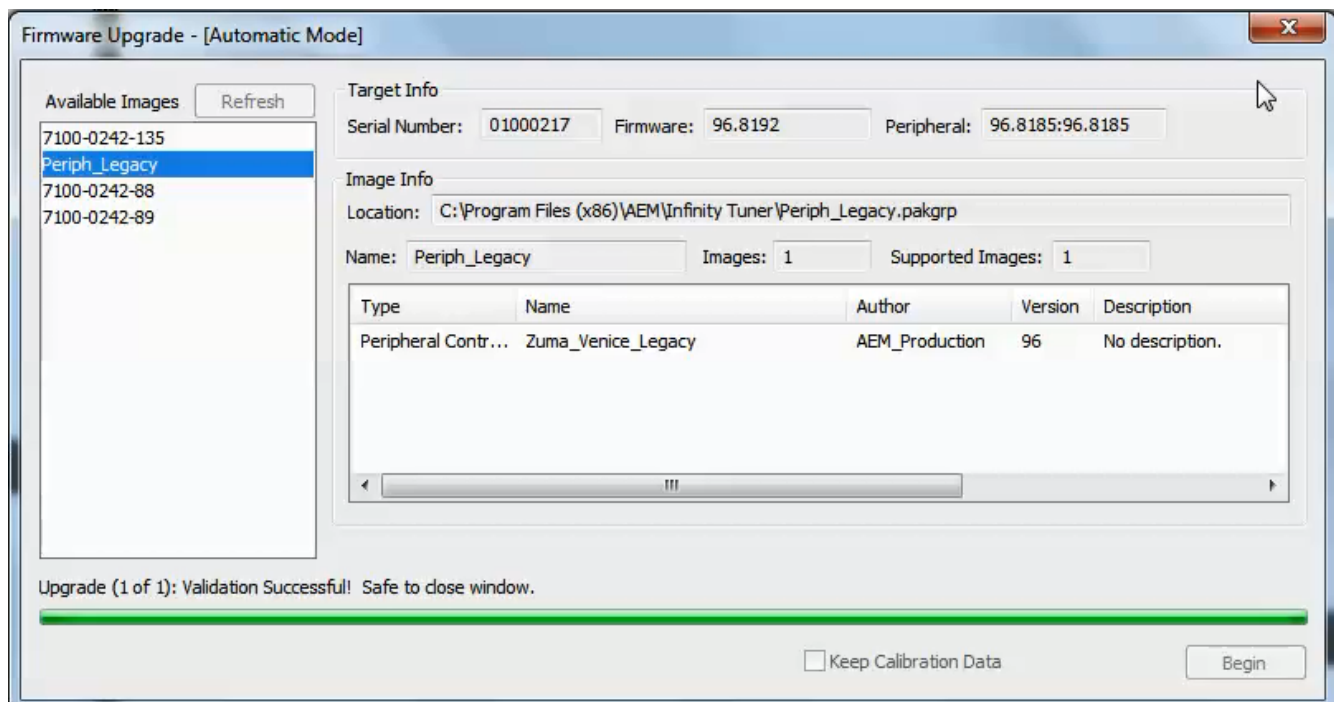

Step 2 - Load old pakgrp file

1) At this point, you can repeat the procedure to load an older pakgrp file.

Infinity Hardware Specifications

Specifications	Infinity-6	Infinity-8h	Infinity-8	Infinity-10	Infinity-812
Cylinders	Up to 6	Up to 8	Up to 8	Up to 10	Up to 12
Injectors, Low Impedance (Sequential)	6	N/A	8	10	12
Injectors High Impedance (Sequential)	Up to 6	Up to 8	8	10	12
Coils – 0–5V Falling Edge	6	8	8	10	10
Connector Pins	80	80	129	129	129
Drive-by-Wire	Single	Single	Dual	Dual	Dual
H-Bridge Channels	1	1	2	2	2
RS232 Channels*	1	1	1	1	1
CAN Channels	2	2	2	2	2
2-Stroke Engines	Yes	Yes	Yes	Yes	Yes
4-Stroke Engines	Yes	Yes	Yes	Yes	Yes
Knock Control	2-Channel	2-Channel	2-Channel	2-Channel	2-Channel
Analog Voltage Inputs	Up to 9	Up to 9	Up to 17	Up to 17	Up to 17
Analog Temp Inputs	Up to 3	Up to 3	Up to 6	Up to 6	Up to 6
VR/Mag Inputs	Up to 4	Up to 4	Up to 6	Up to 6	Up to 6
Digital Inputs	Up to 8	Up to 6	Up to 8	Up to 8	Up to 8
Internal Wideband UEGO Controller	1	1	2	2	2
High Side Outputs	1	1	Up to 2	Up to 2	Up to 2
Low Side Outputs	8	6	10	10	10
4-Wire Stepper Motor Control	Yes	Yes	Yes	Yes	Yes

Specifications	Infinity-6	Infinity-8h	Infinity-8	Infinity-10	Infinity-812
Boost Control (RPM, Time, Gear, VSS, Switch Input, Flex Fuel Content)	Yes	Yes	Yes	Yes	Yes
Engine Protection	Yes	Yes	Yes	Yes	Yes
Variable Cam Control	Up to 2	Up to 2	Up to 4	Up to 4	Up to 4
Launch Control	Yes	Yes	Yes	Yes	Yes
Nitrous Control	Single Stage	Single Stage	Single Stage	Single Stage	Single Stage
Data Logging	Up to 64 GB	Up to 64 GB	Up to 64 GB	Up to 64 GB	Up to 64 GB
Traction Control	Up to 2-Wheel Speed	Up to 2-Wheel Speed	Up to 4-Wheel Speed	Up to 4-Wheel Speed	Up to 4-Wheel Speed
Weather Resistance	Yes, Sealed Enclosure with IP67 Connectors	Yes, Sealed Enclosure with IP67 Connectors	Yes, Sealed Enclosure with IP67 Connectors	Yes, Sealed Enclosure with IP67 Connectors	Yes, Sealed Enclosure with IP67 Connectors
Enclosure Dims	5.855"x5.55"x1. 8"	5.855"x5.55"x1. 8"	6.75"x6.00"x1.8"	6.75"x6.00"x1.8"	6.75"x6.00"x1.8 "
Weight	18.8 oz/476.27g	18.8 oz/476.27g	24oz/680g	24oz/680g	24oz/680g

**Dual use pins. Tx and Rx shared with 2 digital inputs.

ECU Installation

Note: Before installing this system, the vehicle must be in proper working condition. Check the following before installation:

- Fuel pressure (must be set to factory specs)
- Spark plugs (recommend starting with new plugs)
- Ignition timing (must be set to factory specs)
- Fuel filter (recommend starting with new filter)
- Fuel injectors (must be in known good working condition)
- Spark plug wires
- Distributor cap and rotor (if applicable)
- See included fuel system recommendations before starting

This system will not fix any mechanical issues that are causing running problems. Fix any pre-existing problems before installation.

1. Disconnect battery negative cable.
2. Locate factory Engine Control Unit (ECU).
 - a. Most ECUs are located in the passenger kick panel, or passenger floor.

- b. Others are located behind the center console.
- c. Newer vehicles typically mount them in the engine bay.
3. Unplug factory wiring harness plugs at ECU and unscrew fasteners holding ECU in place to remove ECU.
5. Plug factory harness plugs into AEM Infinity Adapter Harness.
 - a. Note: These will only plug in one way.
6. Mounting the AEM Infinity
 - a. It is recommended that the ECU be placed in an environment **that does not expose it to temperatures above 85° Celsius (185F)**.
 - b. In cases where the Infinity is to be used in place of the stock ECU, the location that the stock ECU occupied is best.
 - c. On applications where the ECU is to be located in a different position than stock, the interior of the vehicle is best.
 - d. The Infinity should be located in a place that allows the shortest length of wire to be used while maintaining an environmentally sound location.
 - e. If this is plug-and-play, reference the Application Notes for the proper location.
7. Once the Infinity is mounted, run the USB cable to an easily accessible location away from moisture and any sharp metal corners. Metal stamping can cut through wires very easily. Note: The glove box is an excellent choice for the COM cable location, as it will be used frequently.
8. Re-connect battery cable.

USB & Logging Connectors



The Infinity ECU includes high quality weatherproof bulkhead USB communications. The smaller connector is for PC communications. The larger connector is for logging to a USB stick. Plug one end of a standard USB extension cable (included) into the smaller ECU connector and the other end into an open USB port on the PC. Communication is possible only when the ECU is powered up.

CAUTION

Use care when routing USB extension cables through or around hood opening and door jambs. Cable abuse that causes an internal short can cause ECU damage.

ECU Installation Dimensions Infinity-8/10/12

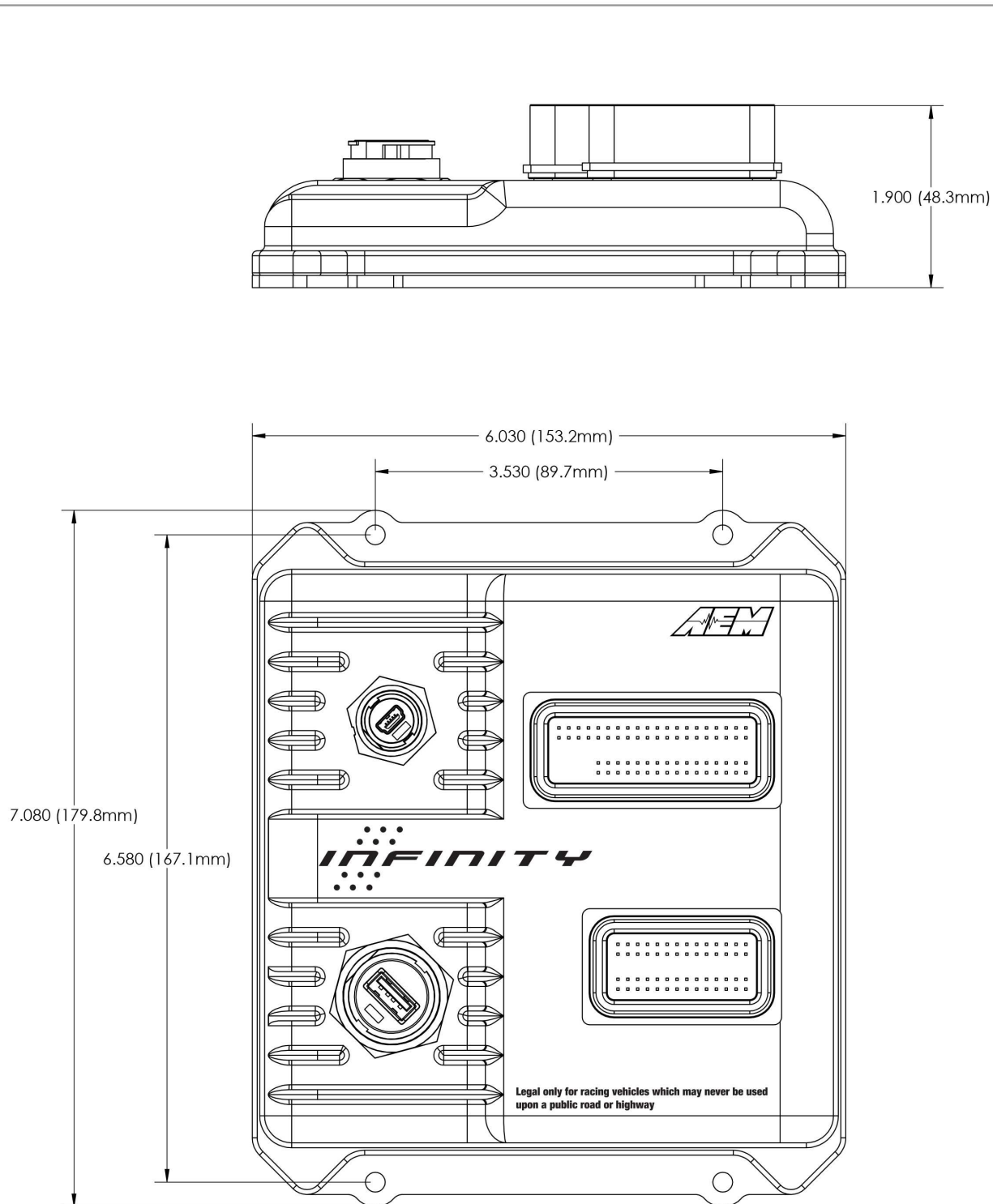

Drawing: Infinity-8/10/12 Dimensions

ECU: Infinity-8/10/12

Date: 07/23/2014

Rev: A

Engineer: Nakano

ECU Installation Dimensions Infinity-6/8h

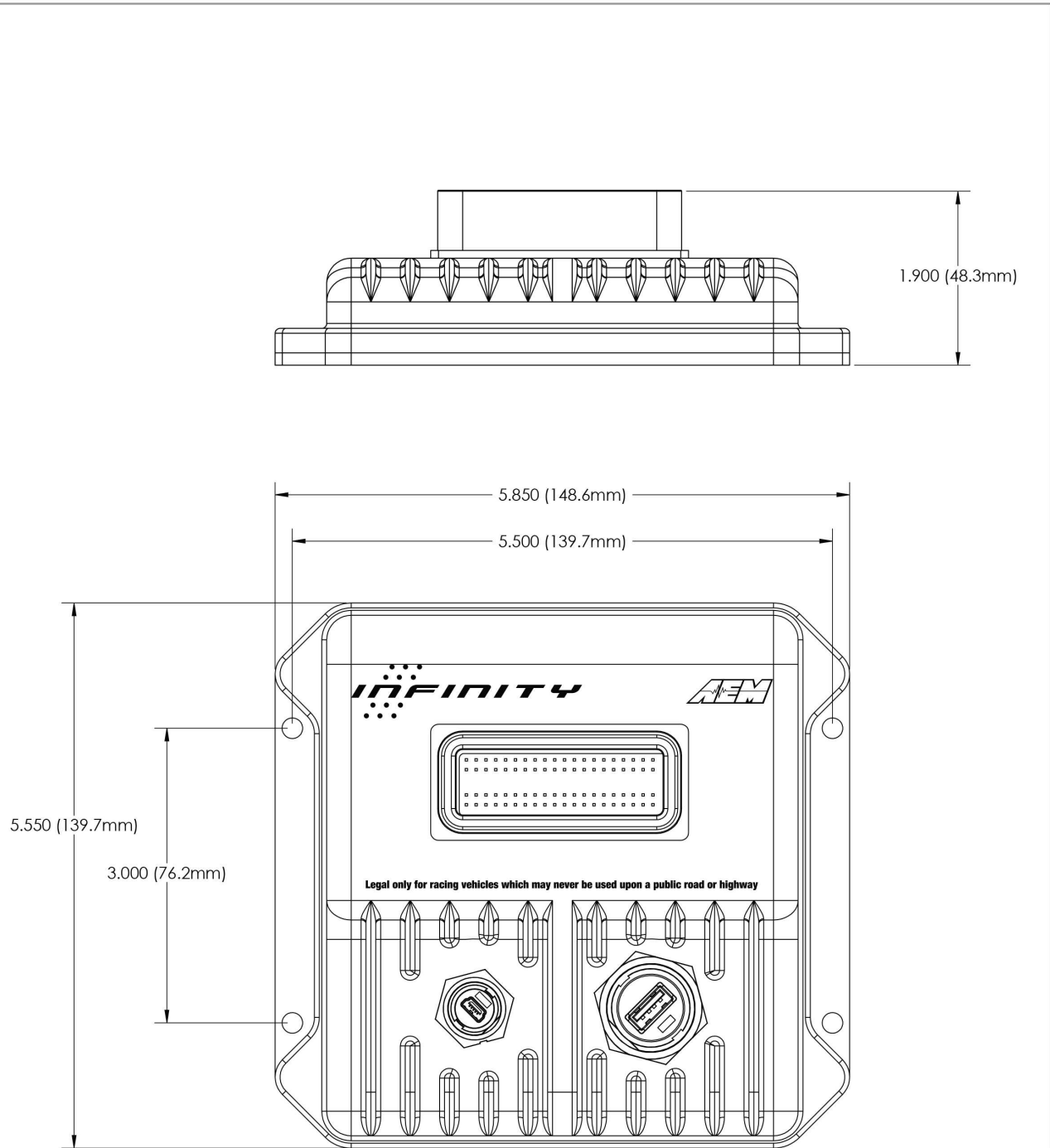

Drawing: Infinity-6/8h Dimensions

ECU: Infinity-6/8h

Date: 07/23/2014

Rev: A

Engineer: Nakano

Tuning Guide

Background

What is “Tuning”? Tuning can mean anything from adjusting the idle mixture screw on a carburetor to experimenting with custom length headers on an engine to setting up the flow ratio between primary and secondary injectors in an EFI calibration. Tuning covers a wide range of topics and not all are related to fuel injection. In its most basic form, EFI tuning involves optimizing the fuel flow and spark advance variables to maximize performance and economy. For the purpose of this manual, tuning refers to the act of making changes to a calibration file for a programmable AEM Infinity ECU to optimize the performance of an engine.

Basic Tuning

Calibration Data

Connecting, Saving and Importing Session Data

- 1) With the Ignition in the ON position and InfinityTuner Running, click on the Connection menu item and select Connect to USB from the dropdown list. A progress bar will be displayed as the laptop gets the calibration info from the ECU.
- 2) Open a layout file by clicking on the Layout menu item and select Open. Layout files have a .itlyt extension and should be saved in the My Documents\InfinityTuner\Layouts folder.
- 3) Save the session file by selecting File – Save session. Session files have a .itssn extension and should be saved in the My Documents\InfinityTuner folder.

The default calibration data provided by AEM should be sufficient to start an engine with similar displacement, sensor setup, and injectors. Every vehicle must be tuned before use. AEM provided base calibration data is installed to the My Documents\AEM\Infinity Tuner\Sessions folder. To import calibration data from a saved session file, go to File > Import calibration data.

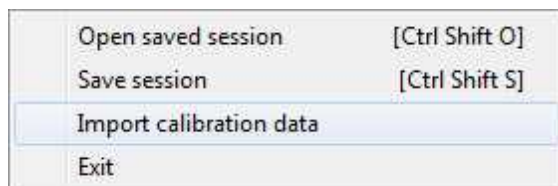

Wait a few moments for the operation to complete. Status messages are displayed during the process notifying the user of each step along the way. If the import function is done while connected to an ECU, after the import is complete:

- 1) Turn the key off and wait for the main relay to power down completely. This usually takes about 10 seconds but depends on the model.
- 2) Turn the key back on.

Certain applications with CAN dash requirements must be powered down completely and restarted after an import calibration. If this is not done, error lights may appear on the dash.

Please be aware of cross-platform differences that may require additional attention after importing calibration data.

For instance, the Digital7 pin is available on the Infinity-6 ECU but not available on the Infinity-8H ECU. After importing Infinity-6 session data to an Infinity-8, any input that was assigned to use Digital7 will be displayed as invalid in the wizard and needs to be reassigned to work properly.

Unit Preferences

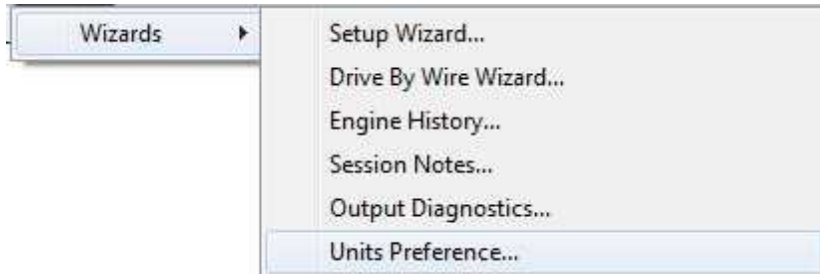

The user can select global unit preferences by going to the menu item Wizard > Units Preference...

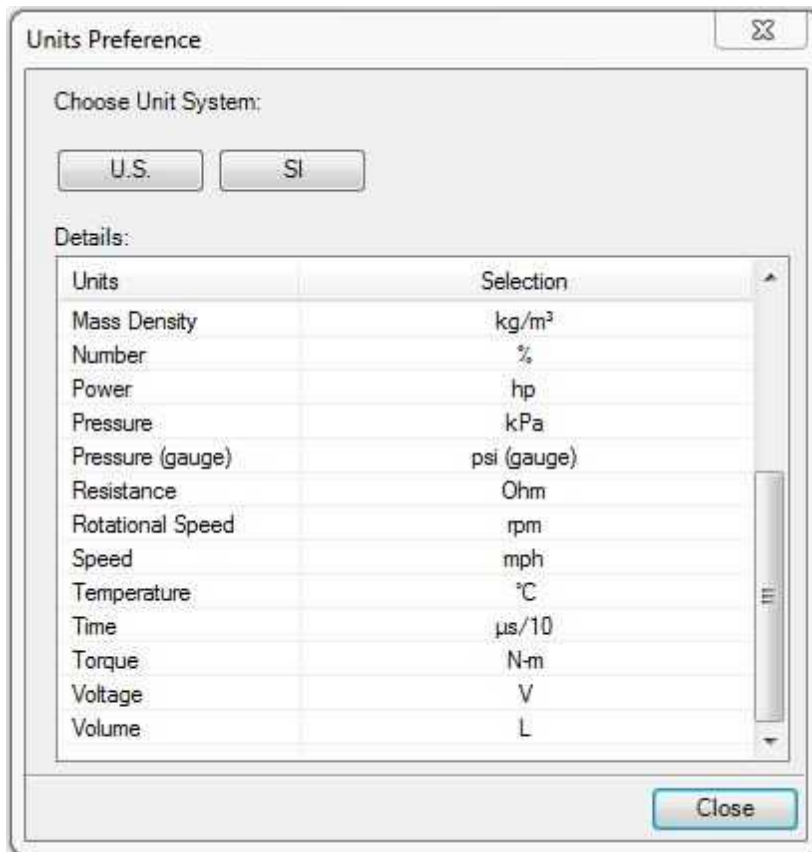

Choose a global unit system (U.S. or SI) or alternately double click on each unit category and select from available options as shown below for pressure.

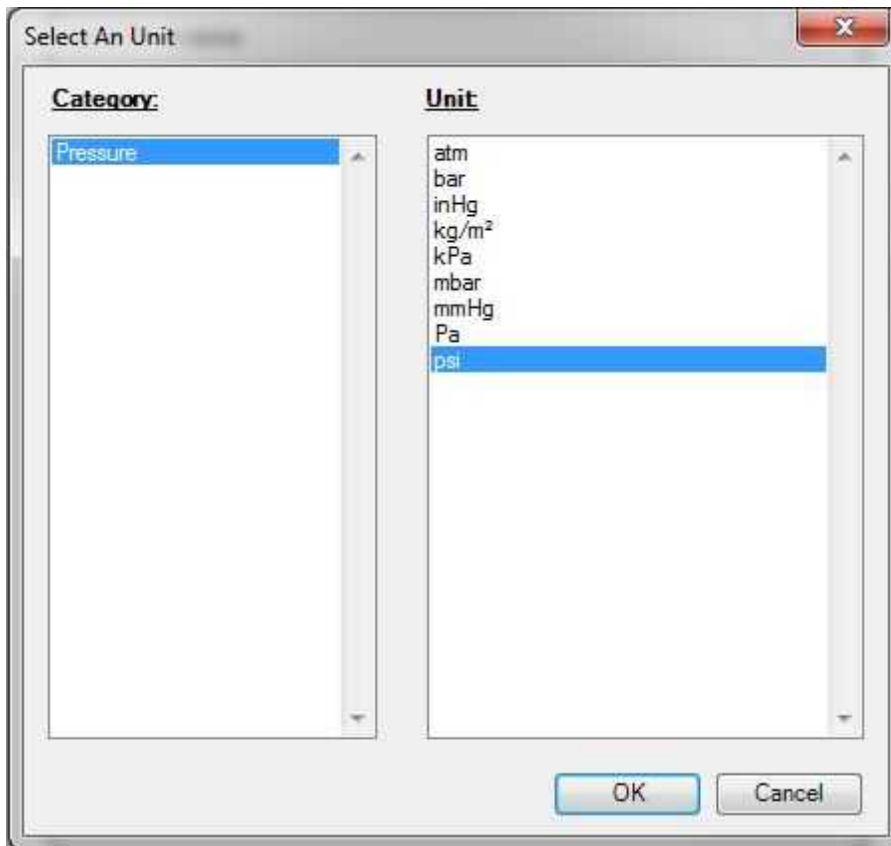

Wizard Basic Setup

Wizard Design

The ECU setup wizard is designed to simplify the initial configuration of the Infinity ECU. ***AEM recommends using the wizard only when connected to the ECU via USB with the power on.*** Most of the setup wizards require the engine to NOT be running. Exceptions will be clearly stated in the function descriptions.

The setup wizard contains general and detailed descriptions with each major function. The most imperative functions are discussed below. Use the descriptions in the wizard to assist in the completion of all other setup features. New setup wizard features are being added constantly. Please follow the written descriptions on each wizard page as this document may not accurately represent the features included in the most recent versions.

The Setup Wizard is a stand alone application that runs in conjunction with Infinity Tuner. This software is updated periodically and its appearance and features may not completely match the descriptions below. In the event of a conflict, refer to the descriptions and instructions on the Setup Wizard pages themselves.

With the laptop connected to the Infinity ECU via USB and InfinityTuner connected, go to the Wizard menu at the top of the InfinityTuner layout and select Setup Wizard. Alternately, the hot key combination [ALT]-[w]-[w]-[w] will launch the setup wizard.

Wizard Organization

The wizard is organized into different sections with expandable menu items on the left hand pane. Use the highlighted arrow below in each section to expand the available sections.

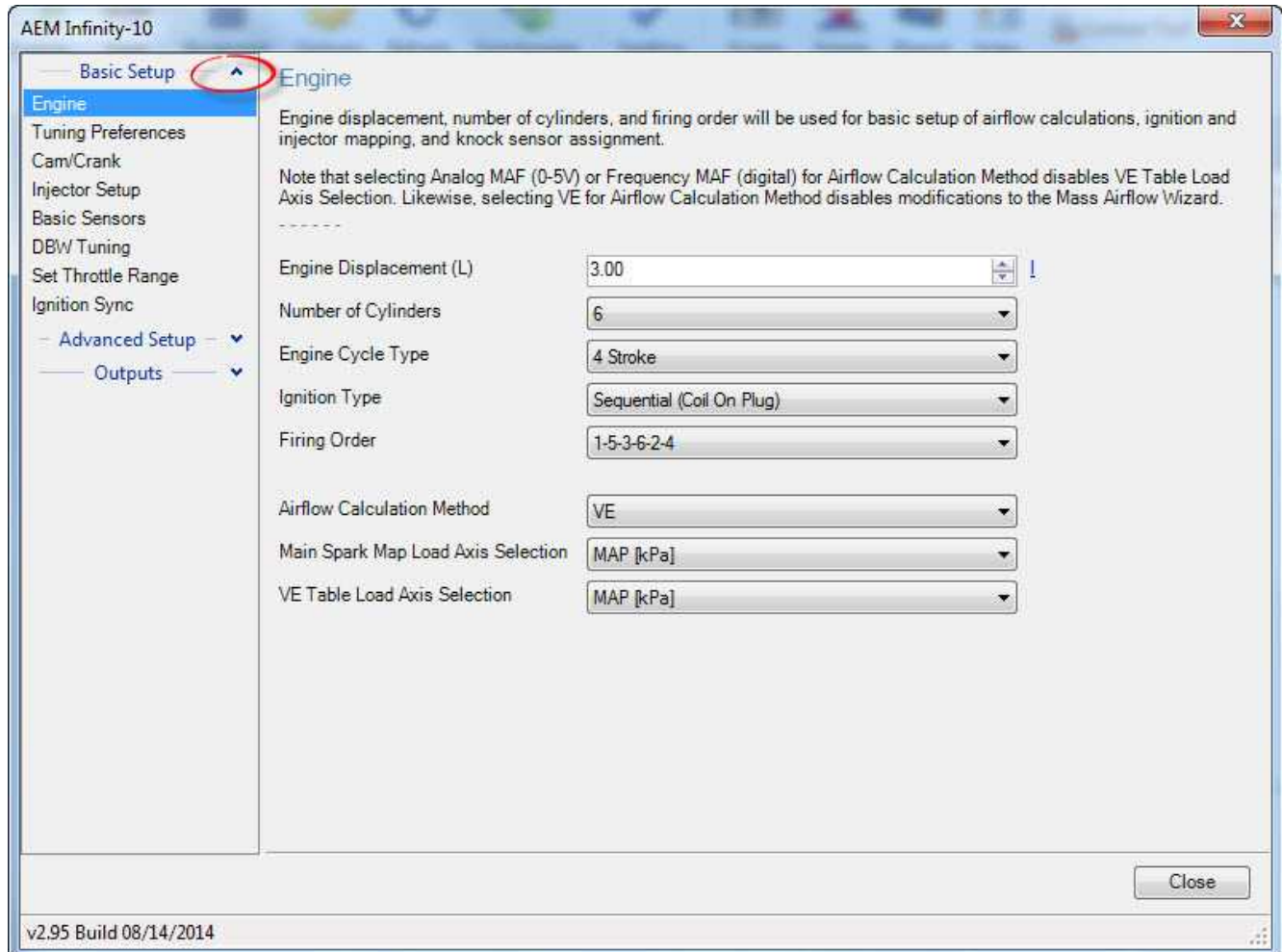

Engine

Basic

Engine displacement, number of cylinders, and firing order will be used for basic setup of airflow calculations, ignition and injector mapping, and knock sensor assignment.

Note that selecting Analog MAF (0-5V) or Frequency MAF (digital) for Airflow Calculation Method disables VE Table Load Axis Selection. Likewise, selecting VE for Airflow Calculation Method disables modifications to the Mass Airflow Wizard.

Engine Displacement (L)	<input type="text" value="3.00"/>
Number of Cylinders	<input type="text" value="6"/>
Engine Cycle Type	<input type="text" value="4 Stroke"/>
Ignition Type	<input type="text" value="Sequential (Coil On Plug)"/>
Firing Order:	<input type="text" value="1-5-3-6-2-4"/>
Airflow Calculation Method	<input type="text" value="VE"/>
Main Spark Map Load Axis Selection	<input type="text" value="MAP [kPa]"/>
VE Table Load Axis Selection	<input type="text" value="MAP [kPa]"/>

Note: This wizard can not be used when the engine is running.

Engine Displacement (L)

Enter the engine displacement in liters.

Min value = 0.250, Max value = 10.0

Number of Cylinders:

Enter the number of cylinders within the engine.

Min value = 1, Max value = 10

Possible values: 1,2,3,4,5,6,8,10

Engine Cycle Type:

Enter the engine type: 2 Stroke or 4 Stroke.

Firing Order:

Select the firing order of the engine.

Airflow Calculation Method:

Select how the airflow calculation is processed. There are 3 options:

VE: This is the default configuration. Airflow is calculated using the speed density algorithm.

0-5V MAF: Airflow is calculated using a 1-axis lookup table that has an analog (0-5V) input from a typical OEM MAF sensor.

Frequency MAF: Airflow calculated using a 1-axis lookup table that has a digital input from a typical OEM MAF sensor

Main Spark Map Load Axis Selection:

This selection will set the load (y-axis) of the ignition maps. Note: The BaseIgnMap and FlexIgnMap must have the same load channel.

Load Axis Channels:

MAP [kPa]
 Throttle [%]
 MassAirflow [gms/s]
 MassAirflow [gms/rev]
 MAP/EBP
 MAP/Baro

VE Table Load Axis Selection:

This is only available if the Airflow Calculation Method is selected. It will set the load (y-axis) of the VE Table.

Load Axis Channels:

MAP [kPa]
 Throttle [%]
 MassAirflow [gms/s]
 MassAirflow [gms/rev]
 MAP/EBP
 MAP/Baro
 DBW_APP1 [%] Filtered

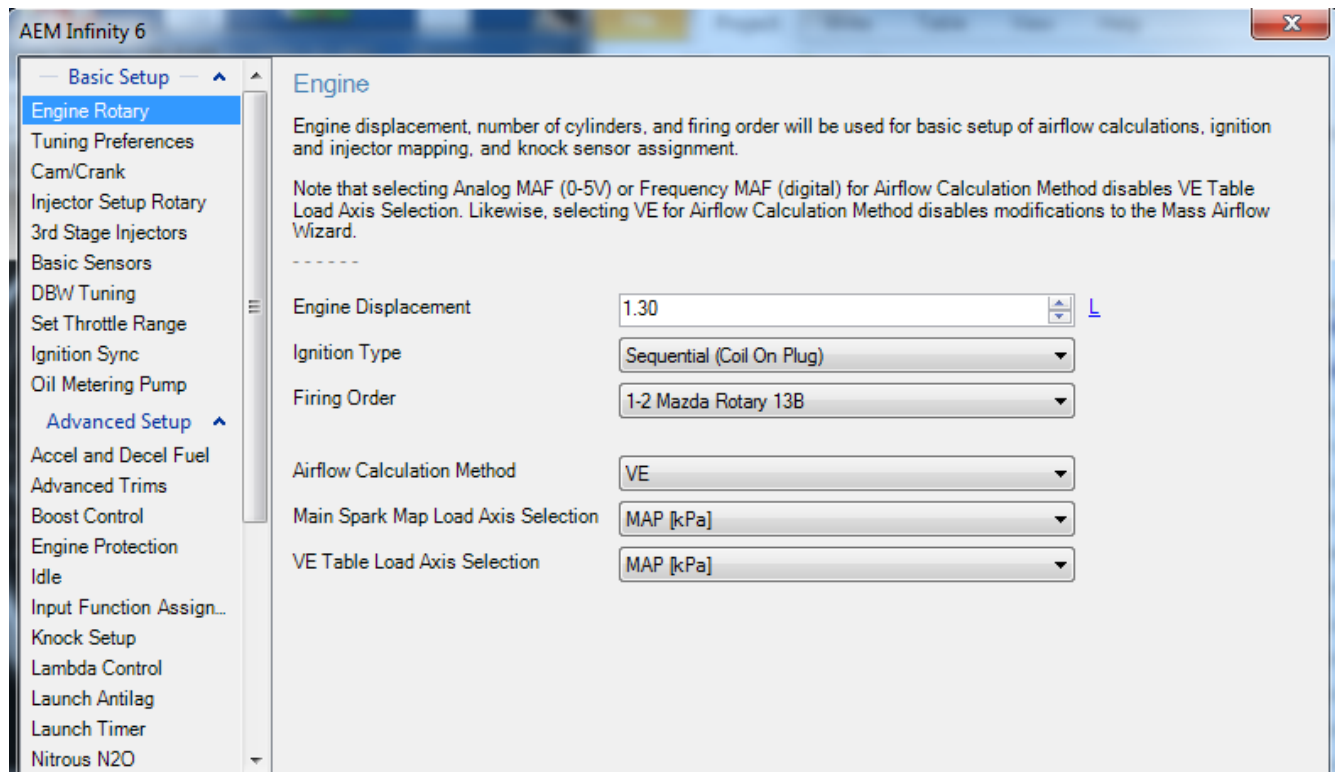
Engine Rotary

Note: This wizard can not be used when the engine is running.

Engine Displacement (L)

Enter the engine displacement in liters.

Min value = 0.250, Max value = 10.0

Ignition Type:

Select proper setup. Options include:

- Sequential (Coil On Plug)
- Wasted Spark
- Distributor
- Mazda RX7 93-95 OEM Ignitor

Firing Order:

Select the firing order of the engine.

Airflow Calculation Method:

Select how the airflow calculation is processed. There are 3 options:

VE: This is the default configuration. Airflow is calculated using the speed density algorithm.

0-5V MAF: Airflow is calculated using a 1-axis lookup table that has an analog (0-5V) input from a typical OEM MAF sensor.

Frequency MAF: Airflow calculated using a 1-axis lookup table that has a digital input from a typical OEM MAF sensor

Main Spark Map Load Axis Selection:

This selection will set the load (y-axis) of the ignition maps. Note: The BaseIgnMap and FlexIgnMap must have the same load channel.

Load Axis Channels:

MAP [kPa]
Throttle [%]
MassAirflow [gms/s]
MassAirflow [gms/rev]
MAP/EBP
MAP/Baro

VE Table Load Axis Selection:

This is only available if the Airflow Calculation Method is selected. It will set the load (y-axis) of the VE Table.

Load Axis Channels:

MAP [kPa]
Throttle [%]
MassAirflow [gms/s]
MassAirflow [gms/rev]
MAP/EBP
MAP/Baro
DBW_APP1 [%] Filtered

Tuning Preferences

Calibration data is automatically saved to ECU flash memory at key off if the "Key Off Commit" function is selected in the Tuning preferences wizard page. Proper power sequencing is critical in order to avoid problems. If power is removed from both pins C1-10 and C2-50 (Infinity 8/10/12 hardware) before this action is completed, the ECU may become inoperable and require reprogramming at AEM.

Tuning Preferences

Key Off Commit:

If Key Off Commit is selected, the ECU will automatically save any unsaved changes when the ignition power input, Pin C1-65 is turned off.

This function could take several seconds to complete.

If power is removed from both pins C1-10 and C2-50 before this action has completed, the ECU may become inoperable and require reprogramming at AEM.

Key Off Commit

Cam/Crank

Choose the Cam/Crank timing type that will be used. The description field notes important information about edge selections and wiring requirements.

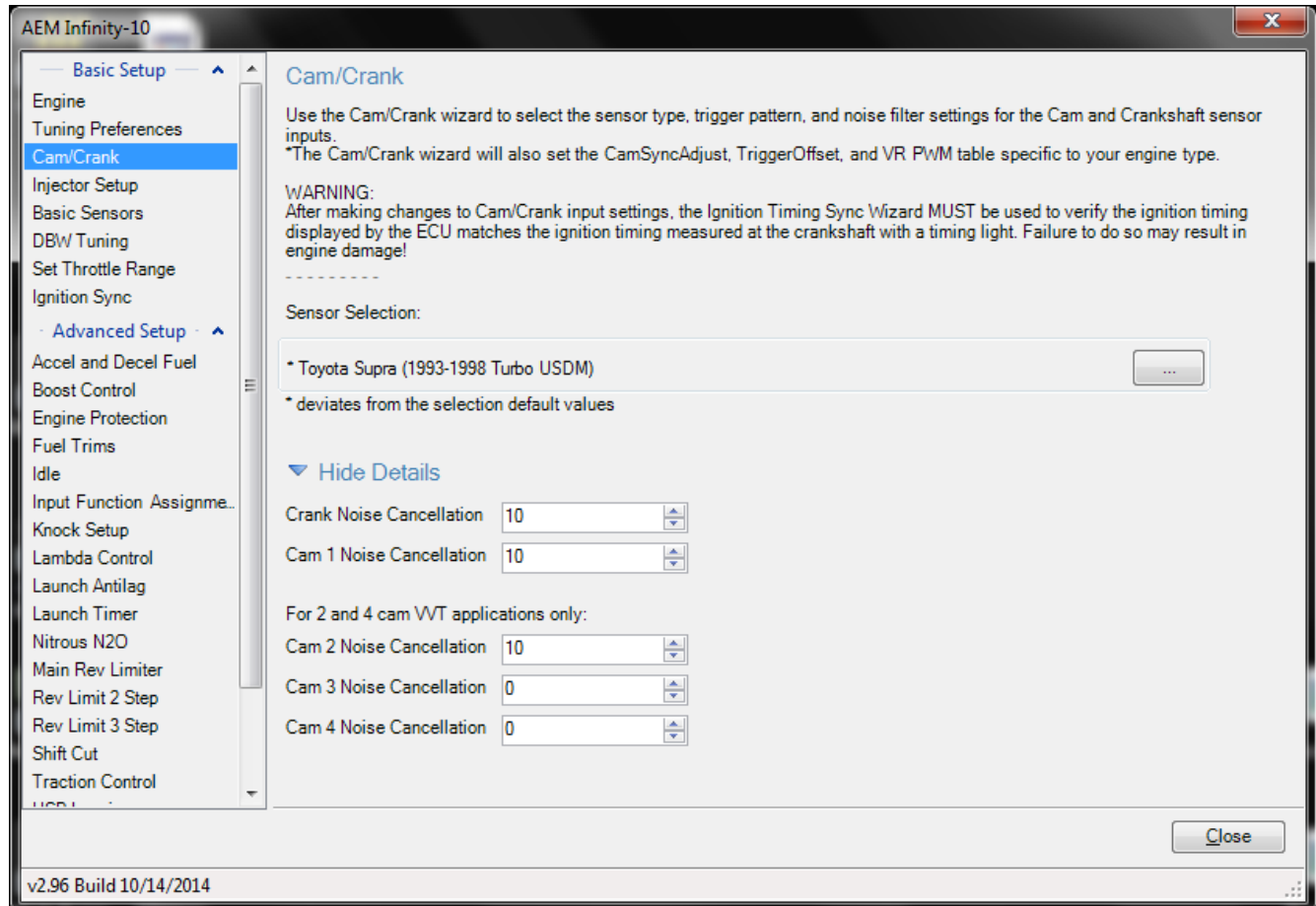

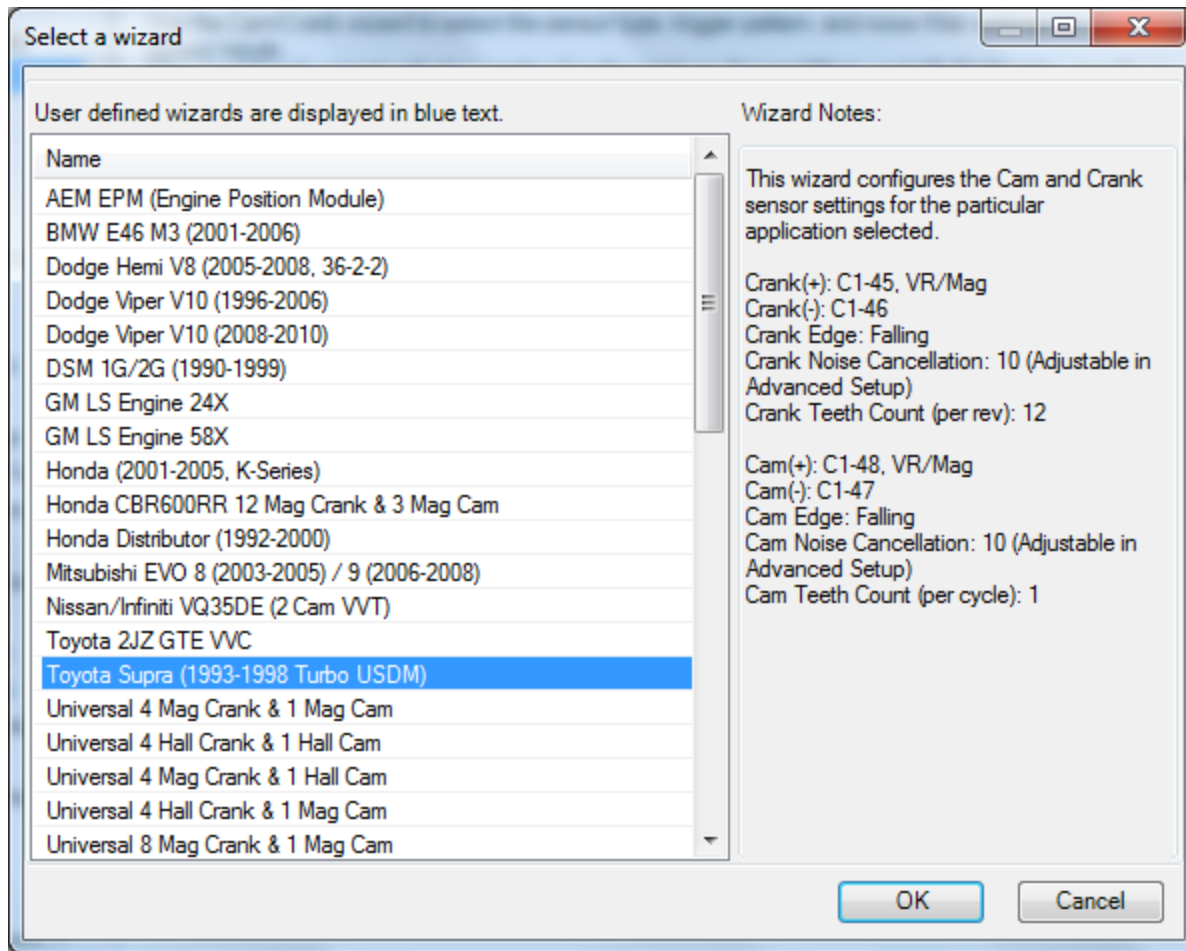

Additional settings exist to adjust noise cancellation. For more details see [Noise Cancellation](#)²⁵⁴

Mass Airflow

Some Infinity application specific models support up to 2 Mass Airflow sensors. The sensor calibrations tables are called MAFX_Cal. Default flow units are grams/second.

MAF1_Cal [gms/s]																													
0.0	2.1	5.6	11.8	25.2	35.0	45.0	56.0	70.0	90.3	106.0	114.7	123.5	132.2	140.7	148.3	156.0	164.4	172.8	181.9	190.7	199.5	208.3	217.1	226.0	234.7	243.6	252.4	261.2	270.0
0.00	1.30	1.62	1.95	2.37	2.66	2.88	3.13	3.33	3.55	3.72	3.85	3.96	4.02	4.07	4.13	4.18	4.24	4.30	4.35	4.40	4.46	4.52	4.57	4.63	4.68	4.74	4.79	4.84	4.90
MAF2_Cal [gms/s]																													
0.0	2.1	5.6	11.8	25.2	35.0	45.0	56.0	70.0	90.3	106.0	114.7	123.5	132.2	140.7	148.3	156.0	164.4	172.8	181.9	190.7	199.5	208.4	217.2	226.0	234.7	243.6	252.4	261.2	270.0
0.00	1.30	1.62	1.95	2.37	2.66	2.88	3.13	3.33	3.55	3.72	3.85	3.96	4.02	4.07	4.13	4.18	4.24	4.30	4.35	4.40	4.46	4.52	4.57	4.63	4.68	4.74	4.79	4.84	4.90

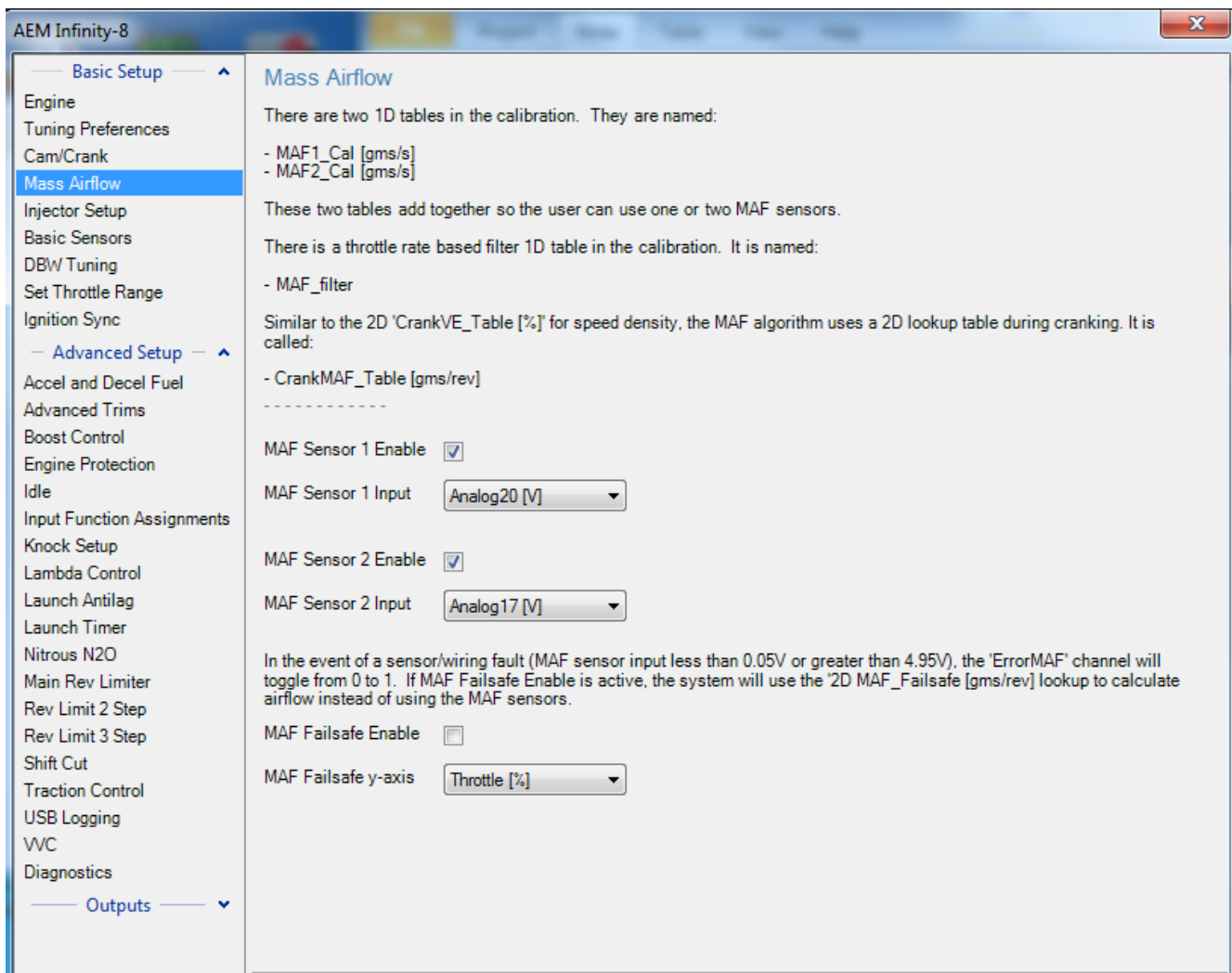

Tuning the MAF filter properly plays an important role for large transient throttle changes. If throttle angle is quickly increased to wide open from a low throttle angle, high manifold vacuum condition, air mass fills the intake manifold (nearly equalizing pressure to atmospheric) at a quicker rate than is consumed by the engine (this is more prominent at lower RPM). Without filtering, this would result in poor (over) fueling. The example below shows higher filtering during quick throttle open events to combat over fueling and a lower filter for throttle closing events to allow for maximum decel fuel cut response.

7000	0.4	0.4	0.8	0.8	0.8
5500	0.4	0.4	0.8	0.8	0.8
4000	0.4	0.4	0.8	0.8	0.8
2500	0.4	0.4	0.8	0.8	0.8
1000	0.4	0.4	0.8	0.8	0.8
	-500	50	100	250	500

Throttle Rate

Crank fuel tuning can be accomplished using the CrankMAF_Table. Native units are grams/rev. Higher numbers will result in a richer mixture during cranking.

90	0.00	0.00	0.00	0.00	0.00
90	0.20	0.20	0.20	0.20	0.20
50	0.18	0.18	0.18	0.18	0.18
25	0.16	0.16	0.16	0.16	0.16
0	0.14	0.14	0.14	0.14	0.14
	50	100	200	300	400

EngineSpeed [RPM]

MAF Sensor 1 Enable:

Enable or disable the MAF 1 input

MAF Sensor 1 Input:

Select from a list of possible analog inputs.

MAF Sensor 2 Enable:

Enable or disable the MAF 2 input

MAF Sensor 2 Input:

Select from a list of possible analog inputs.

MAF Failsafe Enable:

Enable or disable the MAF Failsafe feature.

MAF Failsafe y-axis:

Select from a list of possible inputs for the following failsafe table.

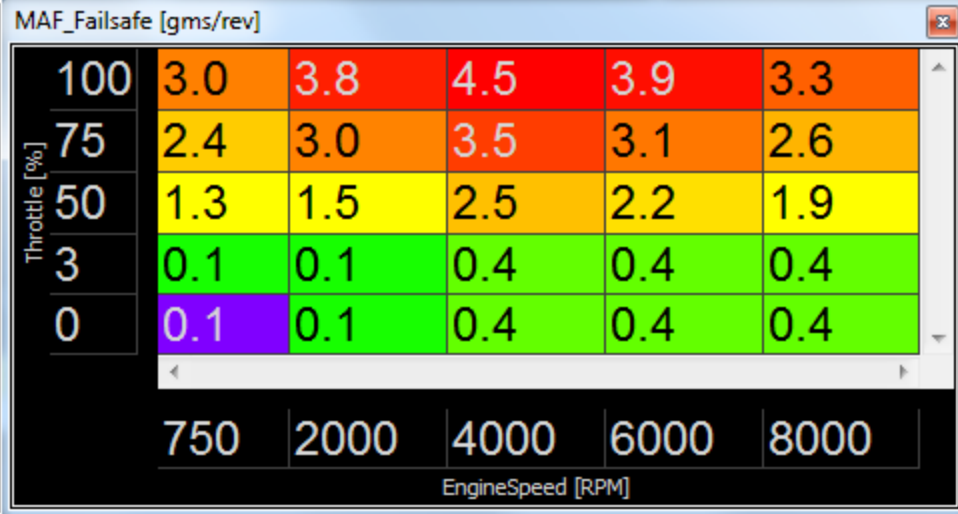

Throttle [%]	750	2000	4000	6000	8000
100	3.0	3.8	4.5	3.9	3.3
75	2.4	3.0	3.5	3.1	2.6
50	1.3	1.5	2.5	2.2	1.9
3	0.1	0.1	0.4	0.4	0.4
0	0.1	0.1	0.4	0.4	0.4

Injector Setup

Injector Setup

The Injector Setup defines the quantity of primary and secondary injectors, fuel types, O2 feedback selection, and injector phasing. There is a fixed offset of 540 degrees for each injector, meaning that Injector 1 has a Phasing of 540 rather than 0 degrees. The phasing for each injector needs to be less than 720. Selecting 'Has Secondary Injectors' enables a drop-down list for each injector Type, allowing the user to designate each injector as primary or secondary. Use the O2 Feedback drop-down lists to assign Lambda feedback to each injector.

Primary Fuel Pressure Regulator Reference Manifold Vacuum Reference ▾

Primary Injector Flow Wizard Selection:

No wizard is selected or matched. Click the Browse button to select one. ...

Primary Injector Duty Limit 95 ▾ [%](#)

Number of Injectors 6 ▾

Has Secondary Injectors

Primary Injector Fuel Type Gasoline ▾

Injector	Type	Phasing	O2 Feedback
Injector 1	Primary	540.00	Lambda1
Injector 2	Primary	300.00	Lambda1
Injector 3	Primary	60.00	Lambda1
Injector 4	Primary	420.00	Lambda1
Injector 5	Primary	660.00	Lambda1
Injector 6	Primary	180.00	Lambda1

Primary Injector Duty Limit

Limits the maximum duty applied to primary injectors.

Min value = 0, Max value = 100

Number of Injectors

The drop down box allows the user to select the desired Number of Injectors.

Min value = 2, Max value = 12

Has Secondary Injectors

If secondary injectors will be used, select this check box. A new fuel type menu is now visible labeled Fuel Type (Secondary Injectors).

See [Staged Injection](#)  for additional tuning information.

Note: If secondary injectors are being used, the option *Has Secondary Injectors* must be selected and the table must be filled out indicating any injector number greater than the number of engine cylinders as secondary. These selections must be made before restarting the ECU and closing the form; otherwise an error will occur. See image below for a typical 6 cylinder engine setup with 6 additional injectors classified as secondary. Note also the option to select a different fuel type for primary and secondary.

Fuel Type

This drop down menu contains the following setup information for primary (and secondary fuel types, if selected).

- Gasoline
- Ethanol
- Methanol
- E85
- Flex Fuel

Phasing

The default injector phasing for the primary injectors is determined from the Firing Order information from the Ignition Wizard. There is a fixed offset of 540 for injectors. After this offset is added, the system checks to see if the result is less than 720. If the result of the calculation is greater than or equal to 720, it is subtracted by 720 from that result

Example:

4 cylinder 1-3-4-2 firing order:

Injector 1 phasing = $0 + 540$ (offset) = 540

Injector 3 phasing = $180 + 540$ (offset) = 0

Injector 4 phasing = $360 + 540$ (offset) = 180

Injector 2 phasing = $540 + 540$ (offset) = 360

O2 Feedback

Lambda sensor assignment is determined by assigning a value of 1 or 2 to the InjXLambdaFB channels. A value of 1 will assign the Lambda 1 sensor and a value of 2 will assign the Lambda 2 sensor. Min value = 1, Max value = 2

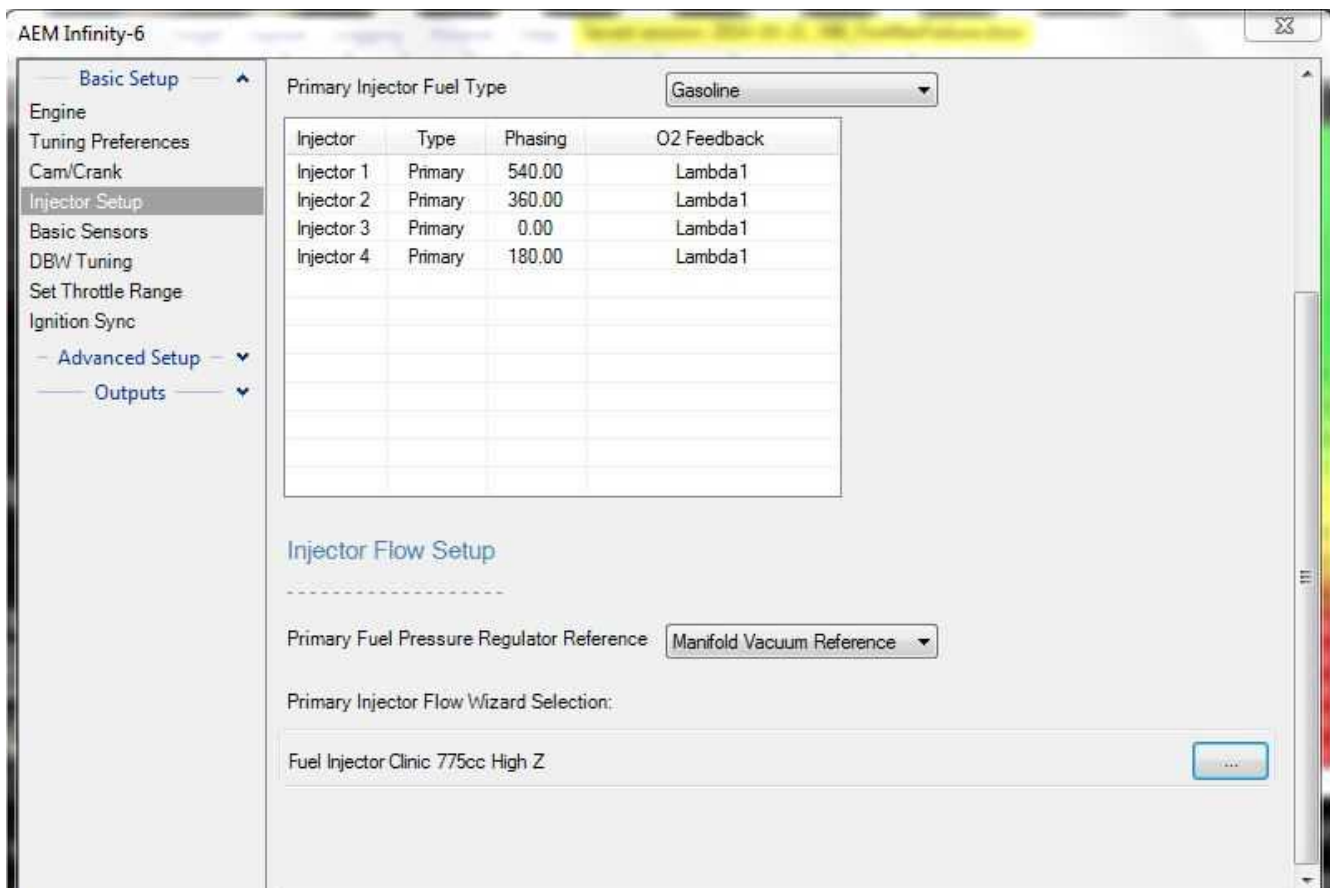

Fuel Pressure Regulator Reference

Allows the user to choose the proper reference pressure for the fuel pressure regulator. The drop down menu has the following options:

Manifold Vacuum Reference: This should be selected if the fuel pressure regulator's port is connected to a vacuum or vacuum/boost source.

Atmospheric Reference: This should be selected if the fuel pressure regulator's port is open to atmosphere or if a dead end fuel system is used where fuel pressure is constant.



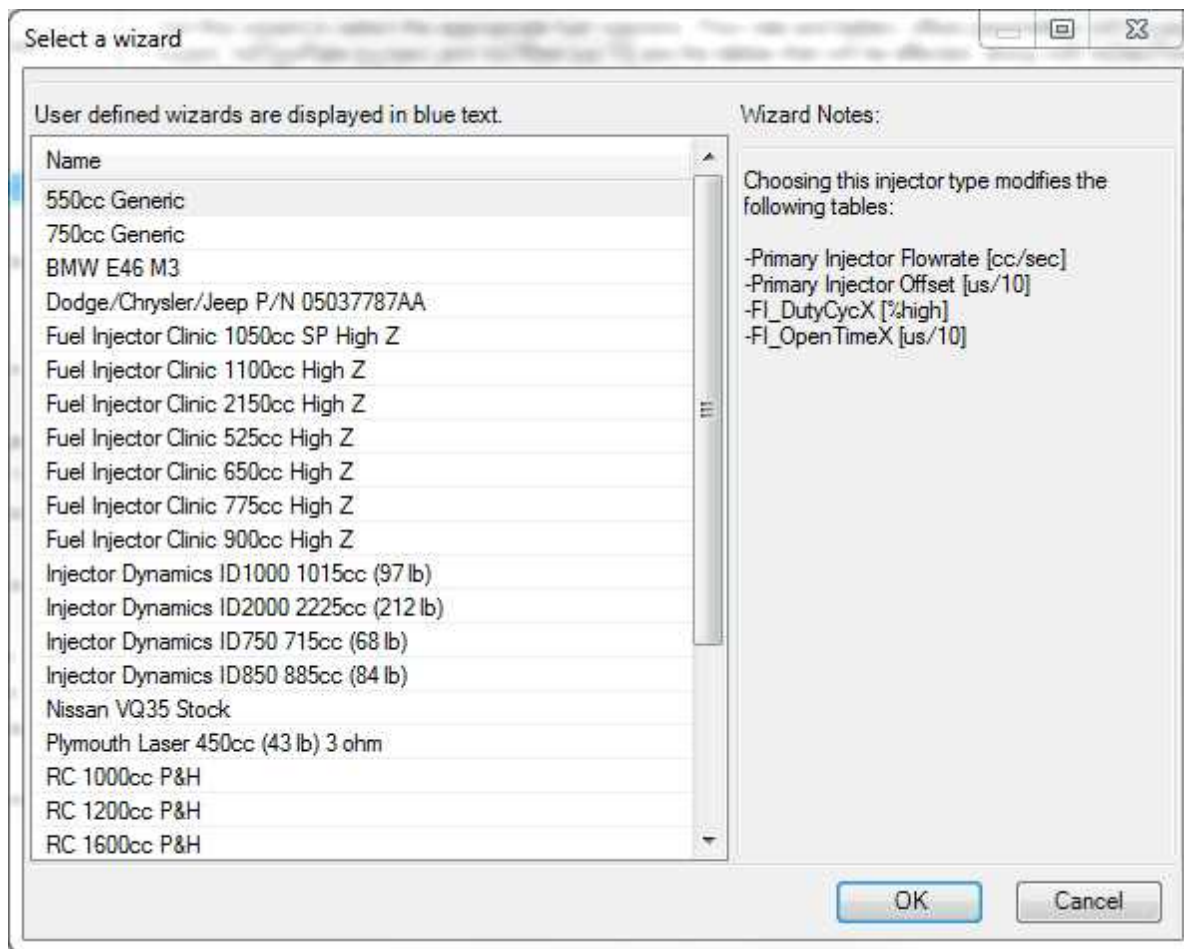

Primary Injector Flow Selection

This database allows the user to select proper primary injector flow data.

InjFlowRate [cc/sec], 1-Axis lookup table of flow vs injector pressure.

InjOffset [us/10], 2-Axis lookup table of PW offset vs battery voltage and injector pressure

Secondary Injector Flow Selection

If Secondary Injectors were selected in the Injector Setup Wizard, this Secondary Injector Flow Selection database will be enabled. This allows the user to select proper secondary injector flow data.

InjSecFlowRate [cc/sec], 1-Axis lookup table of flow vs injector pressure.

InjSecOffset [us/10], 2-Axis lookup table of PW offset vs battery voltage and injector pressure

NOTE: If the Setup Wizard does not contain your specific fuel injector type, you can modify the InjFlowRate table manually. If you do not know the different flow rates at different fuel pressures, choose a flow rate (based on Manufacturers specs) at a known pressure and populate the entire row with that value. For example, you have a fuel injector that is not listed in the Wizard Selection. You know that it flows 475 cc/min at 45 psi. Select the cells in the upper row of the InjFlowRate [cc/min] table and manually input 475. This will suffice to get the car up and running, though proper flow data is ideal.

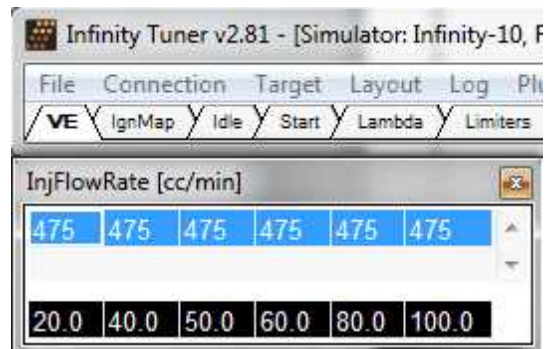
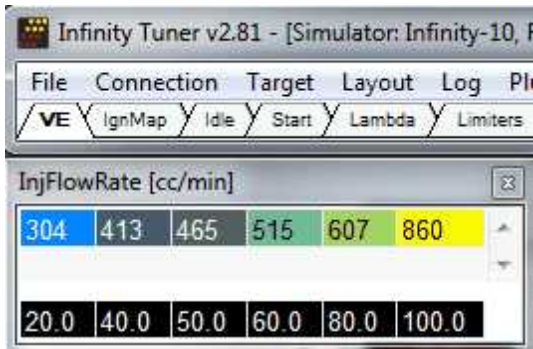

Basic Sensor Setup

Most basic sensors can be configured using this wizard setup window. A summary of the setup data is included in the table shown below. Double clicking on a selection will open a more detailed interface where calibration data can be edited.

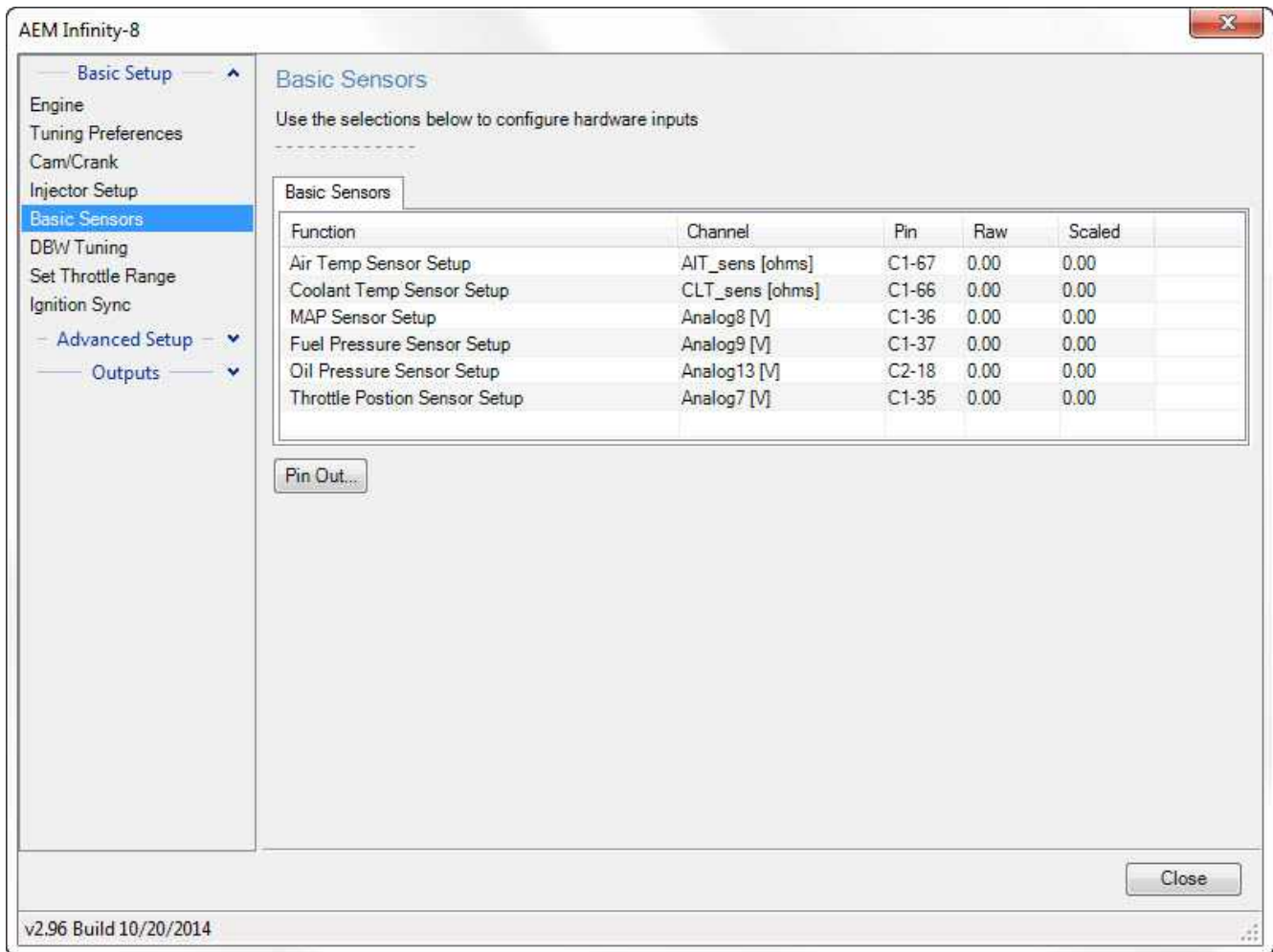

Several examples are shown below. The selections available in base session data may vary by application.

Air Temp Sensor Setup

The Air Temperature wizard sets the Air Temp Failsafe to 25°C and enters the correct Air Temp Sensor Cal Table, Air Temp Fail Max option, and Air Temp Fail Min Option for the specific AIT sensor currently selected.

Live Data

Raw	Scaled
8279.84	29.34

Air Temp Sensor Setup AIT_sens [ohms]

Sensor Selection:

No wizard is selected or matched. Click the Browse button to select one. ...

AIT_sens [ohms]	AirTempCal [C]
346.00	127
419.00	119
625.00	104
886.00	92
1196.00	82
1550.00	74
1970.00	67
2800.00	57
4230.00	46
5274.00	40
7590.00	31
11325.00	22
18560.00	10
29930.00	1
116000.00	-23
545000.00	-49

AIT_sens [ohms]	AirTempCal [C]
346.00	127
419.00	119
625.00	104
886.00	92
1196.00	82
1550.00	74
1970.00	67
2800.00	57
4230.00	46
5274.00	40
7590.00	31
11325.00	22
18560.00	10
29930.00	1
116000.00	-23
545000.00	-49

Air Temp Fail Min -10.0 °C

Air Temp Fail Max 90.0 °C

Air Temp Failsafe On

Air Temp Failsafe 30.0 °C

Air Temp Smoothing 70 %

Close

Air Temperature Sensor Selection:

Select the proper preprogrammed resistance-temperature data of the sensor that is being used.

Air Temp Sensor Input:

Select appropriate input for temperature sensor.

Air Temp Fail Min:

This Air Temp Fail Min should be set to a value that is just above the air temperature value when the sensor is unplugged.

Air Temp Fail Max must be > Air Temp Fail Min.

User entries that do not meet this criteria are not allowed.

Min value = -50, Max value = 300

Air Temp Fail Max:

This Air Temp Fail Max should be set to a value that is just below the air temperature value when the sensor is shorted. This will trigger the failsafe feature. This can be tested and entered by carefully inserting each leg of a paper clip into each terminal of the wiring harness.

Air Temp Fail Max must be > Air Temp Fail Min.

User entries that do not meet this criteria are not allowed.

Min value = -50, Max value = 300

Air Temp Failsafe On:

When clicking, the failsafe feature is enabled. This is typically used when the sensor is mistakenly unplugged or has failed.

Air Temp Failsafe:

The value entered here will be displayed and used for the air temperature corrections when the sensor has failed or is simply unplugged. Min value = -50, Max value = 300

Air Temp Smoothing:

Value used to smooth signal. Min value = 0, Max value = 98

Coolant Temp Sensor Setup

This wizard sets the Coolant Failsafe to 80 C and enters the correct Coolant Sensor Cal Table, Coolant Fail Max Option, and Coolant Fail Min Option for the specific coolant sensor currently selected.

Live Data

Raw	Scaled
1795.31	27.48

Coolant Temp Sensor Setup

Sensor Selection:

No wizard is selected or matched. Click the Browse button to select one.

CLT_sens [ohms]	CoolantTempCal [C]
100.00	125
119.00	111
170.00	96
235.00	84
308.00	74
390.00	66
482.00	59
562.00	56
878.00	45
1175.00	38
1633.00	29
2700.00	19
3657.00	10
5620.00	1
11750.00	-14
77600.00	-49

Coolant Temp Fail Min: °C

Coolant Temp Fail Max: °C

Coolant Temp Failsafe On:

Coolant Temp Failsafe: °C

Coolant Temp Smoothing: %

Coolant Temperature Sensor Selection:

Select the proper preprogrammed resistance-temperature data of the sensor that is being used.

Coolant Temp Sensor Input:

Select appropriate input for temperature sensor.

Coolant Temp Fail Min:

This Coolant Temp Fail Min should be set to a value that is just above the coolant temperature value when the sensor is unplugged.

Coolant Temp Fail Max must be > Coolant Temp Fail Min.

User entries that do not meet this criteria are not allowed.

Min value = -50, Max value = 300

Coolant Temp Fail Max:

This Coolant Temp Fail Max should be set to a value that is just below the air temperature value when the sensor is shorted. This will trigger the failsafe feature. This can be tested and entered by carefully inserting each leg of a paper clip into each terminal of the wiring harness.

Coolant Temp Fail Max must be > Coolant Temp Fail Min.

User entries that do not meet this criteria are not allowed.

Min value = -50, Max value = 300

Coolant Temp Failsafe On:

When clicking, the failsafe feature is enabled. This is typically used when the sensor is mistakenly unplugged or has failed.

Coolant Temp Failsafe:

The value entered here will be displayed and used for the coolant temperature corrections when the sensor has failed or is simply unplugged. Min value = -50, Max value = 300

Coolant Temp Smoothing:

Value used to smooth signal. Min value = 0, Max value = 98.

MAP Sensor Setup

This wizard sets the calibration file for speed density and enters the correct MAP Max Volts, MAP Min Volts, Load Offset and Load Scalar.

Live Data

Raw	Scaled
2.26	151.86

MAP Sensor Setup

Sensor Selection:

No wizard is selected or matched. Click the Browse button to select one.

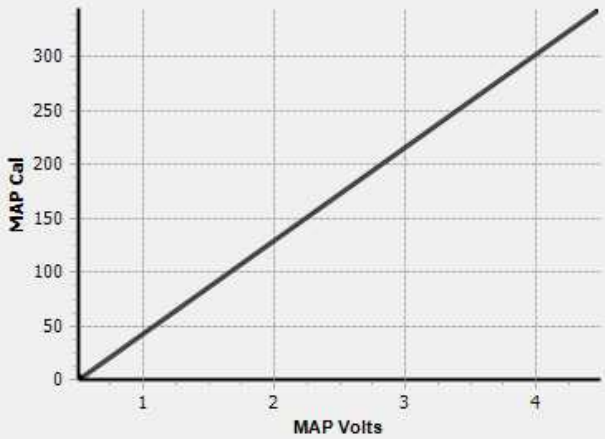

MAP Cal

MAP Volts

MAP Cal Min kPa

MAP Cal Max kPa

MAP Volts Min V

MAP Volts Max V

MAP Smoothing %

Enable MAP Failsafe table

The ECU calculates the value 'MAP_Failsafe' using the table 'PressRatio_Failsafe' multiplied by the Baro Pressure sensor input. If the option 'Enable MAP Failsafe table' is on, this MAP_Failsafe calculation will be used if the MAP sensor volts are out of range. If the option 'Enable MAP Failsafe table' is off, the ECU will continue to use the highest (or lowest) MAP value the sensor can measure when the MAP sensor volts are out of range.

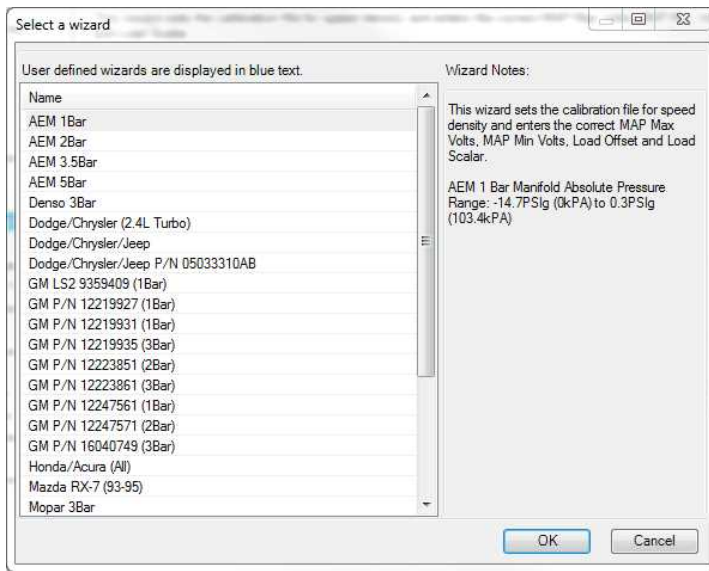

Manifold Pressure Wizard Selection:

Select the proper pre programmed data of the sensor that is being used.

MAP Volts Min:

This should be set to the manufacturer specifications. Otherwise, a value just below a raw MAP voltage that cannot be attained while driving.

MAP Max Volts must be > MAP Min Volts.

User entries that do not meet this criteria are not allowed.

Min value = 0, Max value = 5

MAP Volts Max:

This should be set to the manufacturer specifications. Otherwise, this should be set to a value just below the raw MAP voltage when the sensor is unplugged.

MAP Max Volts must be > MAP Min Volts.

User entries that do not meet this criteria are not allowed.

Min value = 0, Max value = 5

MAP Cal Max [kPa]:

This should be set to the manufacturer specifications.

MAP Cal Max must be > MAP Cal Min.

User entries that do not meet this criteria are not allowed.

Min value = 0, Max value = 700

MAP Cal Min [kPa]:

This should be set to the manufacturer specifications.

MAP Cal Max must be > MAP Cal Min.

User entries that do not meet this criteria are not allowed.

Min value = 0, Max value = 700

MAP Smoothing:

Depending on the wiring, EMI noise can present a problem with the sensor inputs. This value should be calibrated for each specific application. The larger the value, the more data will be collected and averaged. This creates a nice smooth input, however, the response time of the conditioned signal is reduced.

Min value = 0, Max value = 0.98

Enable MAP Failsafe Mode:

The ECU calculates the value 'MAP_Failsafe' using the table 'PressRatio_Failsafe' multiplied by the Baro Pressure sensor input. If the option 'Enable MAP Failsafe table' is on, this MAP_Failsafe calculation will be used if the MAP sensor volts are out of range. If the option 'Enable MAP Failsafe table' is off, the ECU will continue to use the highest (or lowest) MAP value the sensor can measure when the MAP sensor volts are out of range.

Fuel Pressure Sensor Setup
_ □ ×

By default, the ECU will use the value 'Static Fuel Pressure' for fuel calculations. If a Fuel Pressure sensor is installed and the option 'Calculate Fuel Pressure from Sensor' is on, the ECU will adjust fuel calculations using FuelPressDiff [psi], which is the measured difference between FuelPressure [psig] and MAP [psig]. If 'Calculate Fuel Pressure from Sensor' is off, the ECU can still calculate FuelPressDiff [psi] for logging purposes.

Live Data

Raw	Scaled
5.00	45.00

Fuel Pressure Sensor Setup Analog9 [V] ▾

Sensor Selection:

No wizard is selected or matched. Click the Browse button to select one.
...

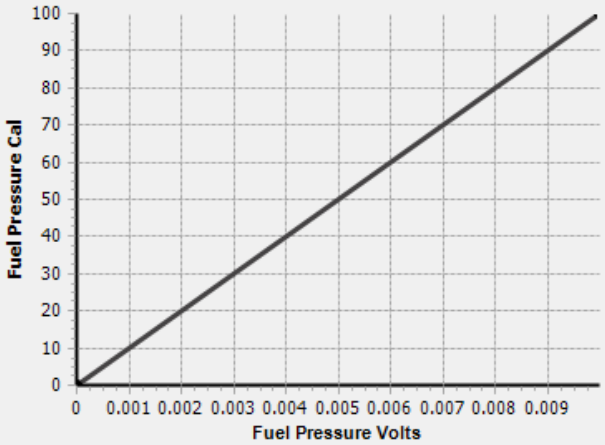

Fuel Pressure Cal

Fuel Pressure Volts

Fuel Pressure Cal Min: psi (gauge)

Fuel Pressure Cal Max: psi (gauge)

Fuel Pressure Volts Min: V

Fuel Pressure Volts Max: V

Static Fuel Pressure: psi (gauge)

Calculate Fuel Pressure from Sensor:

Fuel Pressure Smoothing: %

Fuel Pressure Sensor Failsafe On:

Fuel Pressure Sensor Failsafe: psi (gauge)

Close

Static Fuel Pressure:

Set specific fuel pressure.

Calculate Fuel Pressure from Sensor:

This is a flag that disables false diagnostic errors if a fuel pressure sensor is not installed.

Fuel Pressure Smoothing:

Value used to smooth signal. Min value = 0, Max value = 98.

Fuel Pressure Wizard Selection:

Select the proper preprogrammed data of the sensor that is being used.

Fuel Pressure Min Volts:

This should be set to the manufacturer specifications. Otherwise, a value just below a raw Fuel Pressure voltage that cannot be attained while driving.

Fuel Pressure Max Volts must be > Fuel Pressure Min Volts.

User entries that do not meet this criteria are not allowed.

Min value = 0, Max value = 5

Fuel Pressure Max Volts:

This should be set to the manufacturer specifications. Otherwise, this should be set to a value just below the raw Fuel Pressure voltage when the sensor is unplugged.

Fuel Pressure Max Volts must be > Fuel Pressure Min Volts

User entries that do not meet this criteria are not allowed.

Min value = 0, Max value = 5

Fuel Pressure Cal Min [psig]:

This should be set to the manufacturer specifications.

Fuel Pressure Cal Max must be > Fuel Pressure Cal Min.

User entries that do not meet this criteria are not allowed.

Min value = 0, Max value = 200

Fuel Pressure Cal Max [psig]:

This should be set to the manufacturer specifications.

Fuel Pressure Cal Max must be > Fuel Pressure Cal Min.

User entries that do not meet this criteria are not allowed.

Min value = 0, Max value = 200

Fuel Pressure Failsafe On:

This enables the failsafe that is typically used when the sensor is mistakenly unplugged or has failed.

Fuel Pressure Failsafe:

The value entered here will be displayed and used for the fuel pressure corrections when the sensor has failed or is simply unplugged. Min value = 0, Max value = 100

Oil Pressure Sensor Setup

This wizard enters the correct Oil Pressure Min Volts, Oil Pressure Max Volts, Failsafe On, Oil Pressure Failsafe, Load Offset and Load Scalar.

Live Data

Raw	Scaled
4.99	12.00

Oil Pressure Sensor Setup

Sensor Selection:

AEM 150 PSI Pressure Sensor

Oil Pressure Cal Min [psi \(gauge\)](#)

Oil Pressure Cal Max [psi \(gauge\)](#)

Oil Pressure Volts Min [V](#)

Oil Pressure Volts Max [V](#)

Close

Oil Pressure Sensor Installed

If a oil pressure sensor is installed, check this box.

Oil Pressure Wizard Selection

Selecting this box will present a menu with multiple pre configured oil pressure sensors to choose from.

Show Details

When selecting, the following options will be displayed.

Oil Pressure Min Volts:

This sets the minimum voltage capable from a properly working sensor. Check the manufacturer specifications for more information. Min value = 0, Max value = 5. Oil Pressure Max Volts must be > Oil Pressure Min Volts. User entries that do not meet this criteria are not allowed.

Oil Pressure Max Volts:

This sets the maximum voltage capable from a properly working sensor. Check the manufacturer specifications for more information. Min value = 0, Max value = 5. Oil Pressure Max Volts must be > Oil Pressure Min Volts. User entries that do not meet this criteria are not allowed.

Oil Pressure Cal Min [psig]:

This sets the minimum pressure capable, in psig, from a properly working sensor. Check the manufacturer

specifications for more information. Min value = 0, Max value = 200. Oil Pressure Cal Max must be > Oil Pressure Cal Min. User entries that do not meet this criteria are not allowed.

Oil Pressure Cal Max [psig]:

This sets the maximum pressure capable, in psig, from a properly working sensor. Check the manufacturer specifications for more information. Min value = 0, Max value = 200. Oil Pressure Cal Max must be > Oil Pressure Cal Min. User entries that do not meet this criteria are not allowed.

Oil Pressure Failsafe On:

When clicking, the failsafe feature is enabled. This is typically used when the sensor is mistakenly unplugged or has failed.

Oil Pressure Failsafe:

The value entered here will be displayed and used for the oil pressure corrections when the sensor has failed or is simply unplugged. Min value = 0, Max value = 150

DBW Tuning

DBW Tuning

Drive by Wire Setup...

Drive-by-Wire 1 User Enable

Drive-by-Wire 2 User Enable

DBW Idle Control

DBW Idle Control Range %

The calculated 'Idle Position' value will be rescaled such that 100% for Idle Position will increase the calculated DBW_Target by this amount. Typical value = 5 which represents 5% maximum throttle increase due to idle control calculations (0% to +5%). The larger the throttle body compared to your engine size the smaller this number will be.

Show Advanced Setup

Note: Data will not be shown here if "Drive-by-Wire 1 User Enable" is disabled. Enable "Drive-by-Wire 1 User Enable" to view the following DBW Tuning settings.

Drive by Wire Setup...:

Selecting this box will open the DBW wizard for configuring throttle bodies.

Drive-by-Wire 1 User Enable:

Enable or disable DBW 1.

Drive-by-Wire 2 User Enable:

Enable or disable DBW 2

DBW Idle Control:

DBW Idle Control Range:

Set percentage of maximum throttle body movement for Idle control.

Advanced Setup:**Hide Advanced Setup**

DBW Frequency [Hz](#)

DBW PID Settings

DBW Proportional Gain

DBW Integral Gain

DBW Derivative Gain

PID Integral Clamps

DBW Integral Clamp High Typical value is between 10 to 20

DBW Integral Clamp Low Typical value is between -10 to -20

Sensor Smoothing

DBW Accel Pedal Smoothing %

DBW Throttle Smoothing %

Mode Select

The ModeSelect_DBW table is used to choose when to use the DBW_ThrottleCurve1 table or the DBW_ThrottleCurve2 table for calculating desired throttle position.

ModeSelect_DBW x-axis input

DBW_Close duty cycle limit %

Error Response

Fuel and spark will be cut if EngineSpeed exceeds this value while after the DBW throttle has been disabled due to errors

DBW Error Rev Limit [rpm](#)

To prevent unsafe conditions, the DBW throttle outputs will be disabled if the actual throttle position differs from the target throttle position for approximately 1 second while the engine is running. To simplify the PID tuning process, DBW Tracking Errors can be disabled at 0 RPM. Turning this option 'OFF' will allow different PID values to be evaluated when the engine is off, without the DBW system shutting down due to poor throttle tracking. Note that most DBW throttles are sensitive to system voltage below 13.5V, so it is recommended to perform this testing with a battery charger connected.

DBW Tracking Errors at 0 RPM

DBW Frequency:

Frequency in which ECU communicates with throttle body; this number varies by manufacturer and can cause errors or erratic behavior if not set properly.

DBW PID Settings:**DBW Proportional Gain:**

Proportional control is a pure gain adjustment acting on the magnitude of the target error to provide the system response. The advantage of a proportional-only control is it can respond quickly to large errors; when the error is large the proportional response will be large. The disadvantage of proportional gain for DBW control is the proportional response will decrease to zero as the engine speed gets closer to the idle target RPM, and this tends to result in 'hunting' or fluctuations in engine speed. It is recommended to begin tuning DBW feedback with this value set to zero or very low values. If the system responds too slowly to quick disturbances, increase this value slightly.

Min value = 0.000, Max value = 10.000

DBW Integral Gain:

Integral control uses an integrator or 'accumulator' method, essentially checking if the target error is positive or negative and then taking one step up or one step down every 400ms to reduce the target error. The advantage of integral response for DBW control is the throttle will be slowly and smoothly adjusted until the engine speed reaches the target, and then remain at whatever feedback value reached the target. Note: although Integral gain is less likely to cause hunting or fluctuations than Proportional or Derivative gains, excessively high Integral values will take steps that are too large which can result in instability.

Min value = 0.000, Max value = 300.000

DBW Derivative Gain:

The derivative term adjusts the feedback based on the rate of change of the target error. Derivative control is used to reduce the magnitude of the overshoot produced by the Proportional component and improve the combined controller-process stability. Note: For most setups, it is recommended to leave the Derivative gain set to zero. For tuners who are very familiar with PID feedback and are observing a situation that could be alleviated by adjusting Derivative gain, it is recommended to use the Idle_Decel table rather than the Derivative gain.

Min value = 0.000, Max value = 1.000

PID Integral Clamps:**DBW Integral Clamp High:**

Maximum value for DBW Integral to prevent overshooting and better sync with target.

DBW Integral Clamp Low:

Minimum value for DBW Integral to prevent undershooting and better sync with target.

Sensor Smoothing:**DBW Accel Pedal Smoothing:**

Value used to smooth signal. Min value = 0, Max value = 85.

DBW Throttle Smoothing:

Value used to smooth signal. Min value = 0, Max value = 60.

Mode Select:

ModeSelect_DBW x-axis input:

Input for choosing between different DBW throttle curves. See [Advanced Tuning -> Multi-Map Features](#) ^[24] for details on changing throttle curves on the fly.

Error Response:**DBW Error Rev Limit:**

RPM limit before fuel and spark will be cut off. Min value = 0, Max value = 3000.

DBW Tracking Errors at 0 RPM:

Enable or disable tracking errors when Engine Speed is at 0 RPM.

Set Throttle Range



The wizard displays a warning message to the user if the software is not connected to a hardware target.

Live TPS Volts

Text and graphical representation of the raw analog voltage is shown.

Steps**Set TPS Volts Min**

Press this button when the throttle pedal is fully released. This will write the current value of Analog7 [V] to the Throttle_raw [%] Analog In conditioner and display the resultant value on the TPS Min Volts: X.XX display.

Set TPS Volts Max

Press this button after the throttle pedal is fully depresses. This will write the current value of Analog7 [V] to the Throttle_raw [%] Analog In conditioner and display the resultant value on the TPS Max Volts: X.XX display.

Ignition Sync

Ignition Sync

The purpose of the Ignition Timing Sync Wizard is to ensure that the ignition timing measured at the crankshaft matches the SpkTiming [DegBTDC] channel displayed by Infinity Tuner. Lock the ignition timing at the chosen setpoint and compare with the timing mark on the vehicle's crankshaft pulley using a timing light. Use the Large (5 degree increments) and the Small (0.5 degree increments) Sync Adjustments to match the target and actual ignition timing.

Ignition Timing

Lock ignition timing at degrees BTDC.

Sync Adjustment

Advance Timing

Retard Timing

Hide Advanced Setup

Trigger Offset: degrees BTDC

The Pickup Sensor Delay is used to compensate for very small delays inherent in the vehicle's timing inputs and ignition outputs. If the timing at the crankshaft is accurate at low RPM but slightly retarded at high RPM, increase the Pickup Sensor Delay value.

Pickup Sensor Delay: Less - us

The engine's ignition timing must be synchronized with the Infinity Tuner's ignition timing display. This is crucial with older vehicles that have adjustable distributors, adjustable cam angle sensors, etc. Most modern engines do not utilize a manual adjustment for ignition timing. However, this wizard should always be used for verification as sensors can be frequently installed backwards or upside down. This can catch a problem before damage occurs.

Note: This wizard can only be used when the engine speed is greater than 50 RPM. The ignition timing will automatically unlock when the window is closed reverting back to the normal calculated value.

Ignition Timing

For synchronizing, the ignition timing can be locked by checking the box.
Allowable values: Min value = 0, Max value = 45

Sync Adjustment

The window includes 4 buttons. Two buttons are used to Advance Timing and TWO buttons are used to Retard Timing.

The button labeled Large edits the CamSyncAdjustment TrigOffset [degBTDC] channel in 1.0 deg steps. The range is 0 to 719 degrees. The button labeled Small edits the TrigOffset [degBTDC] channel in 0.1 deg steps.

The TrigOffset [degBTDC] is adjustable by Resolution. The Resolution setting has a range of 0.25 deg to 2.0 degrees in 0.25 degree increments. This “stepping” function allows the user to make TrigOffset [degBTDC] adjustments with the Small button up to the range limit.

Advanced Setup

Pickup sensor delay

The More and Less buttons increase/decrease the SpkDelayComp [us] value in increments/decrements of 5.

Min value = 0, Max value = 500

Two separate procedures are required depending on the Infinity application: Plug and Play or Universal Application.

Plug and Play

- a. In the Ignition Sync wizard, select the checkbox “Lock ignition timing at” and set the “degrees BTDC” (10.0 deg BTDC is the default).
- b. Start the engine and use a timing light to verify that the crankshaft timing matches the locked ignition timing set point (10.0 deg BTDC if using the default setting).
- c. If there is a deviation between the locked set point and the actual timing observed with the timing light, use the Sync Adjustment arrows to match the wizard-displayed value with the actual value. As the Sync Adjustment arrows are advanced or retarded, the timing observed on the crankshaft will change, while the “Lock ignition timing at 10.0 degrees BTDC” will remain constant.

Universal Application

- a. In the Ignition Sync wizard, select the checkbox “Lock ignition timing at” and set the “degrees BTDC” (10.0 deg BTDC is the default).
- b. **Do NOT attempt to start the engine.** Disable (unplug) the fuel injectors and/or fuel pump.
- c. While cranking the engine, use a timing light to verify that the crankshaft timing matches the locked ignition timing set point (10.0 deg BTDC if using the default setting).
- d. If there is a deviation between the locked set point and the actual timing observed with the timing light, use the Sync Adjustment arrows to match the wizard-displayed value with the actual value. As the Sync Adjustment arrows are advanced or retarded, the timing observed on the crankshaft will change, while the “Lock ignition timing at 10.0 degrees BTDC” will remain constant.
- e. Reconnect the fuel injectors and fuel pump.
- f. Once the remaining Setup Wizards have been configured, repeat the Ignition Sync process with the engine running to ensure that the crankshaft timing matches the locked ignition timing set point.

Oil Metering Pump

Oil Metering Pump

This wizard configures the Oil Metering Pump stepper motor control.

Oil Metering Pump Installed

OMP Sensor Setup

OMP Analog Input: Analog11 [V]

OMP Volts Min: 0.97

OMP Volts Max: 4.59

OMP Cal Min: 0

OMP Cal Max: 100

OMP Load Axis

The OMP Load [%] table is used to correlate engine load (manifold pressure) to OMP stepper position. In the event of a MAP sensor error, the OMP Load [%] Failsafe table (TPS based) will automatically be used to determine engine load.

OMP Load [%] Table y-axis: MAP [kPa]

OMP Load [%] Failsafe Table y-axis: Throttle [%]

OMP Engine Protection

OMP Engine Protection can be used to set Fuel and Spark limiters if the OMP stepper motor is not tracking within the specified tolerance 'OMP Error Position Max [%]'

OMP Failure Fuel Cut Enable

OMP Failure Spark Cut Enable

OMP Fuel Cut [RPM]: 2000

OMP Spark Cut [RPM]: 3000

OMP Error Position Max [%]: 5

OMP Stepper Setup

The oem Densor Oil Metering Pump has been characterized, and the following default settings are recommended: OMP Max Steps: 70, OMP Pulses Per Step: 1, OMP Pulse Delay: 4

OMP Max Steps: 70

OMP Pulses Per Step: 1

OMP Pulse Delay [ms]: 4

Oil Metering Pump Installed

Select if using an oil metering pump.

OMP Analog Input

Select the analog sensor inputs used for oil metering pump position. This is used for error detection.

OMP Volts Min:

This should be set to the manufacturer specifications.

OMP Max Volts must be > OMP Min Volts.

User entries that do not meet this criteria are not allowed.

Min value = 0, Max value = 5

OMP Volts Max:

This should be set to the manufacturer specifications.

OMP Max Volts must be > OMP Min Volts.

User entries that do not meet this criteria are not allowed.

Min value = 0, Max value = 5

OMP Cal Max:

This should be set to the manufacturer specifications.

OMP Cal Max must be > OMP Cal Min.

User entries that do not meet this criteria are not allowed.

Min value = 0, Max value = 105

OMP Cal Min:

This should be set to the manufacturer specifications.

OMP Cal Max must be > OMP Cal Min.

User entries that do not meet this criteria are not allowed.

Min value = -5, Max value = 104

OMP Target Table y-axis

y-axis input options for OMP Target Table

OMP Target Failsafe Table y-axis

y-axis input options for OMP Target Failsafe Table

OMP Failure Fuel Cut Enable

Select to enable a fuel cut at the specified RPM in the event of an OMP control fault

OMP Failure Spark Cut Enable

Select to enable a spark cut at the specified RPM in the event of an OMP control fault

OMP Fuel Cut [RPM]

Target fuel cut RPM limit in the event of an OMP control fault

OMP Spark Cut [RPM]

Target spark cut RPM limit in the event of an OMP control fault

OMP Error Position Max [%]

Tracking errors greater than this value will cause a control fault.

Follow ECU

The follow ECU feature forces a small cell selection to "follow" the ECU as the table input data changes. Using this feature combined with the hot key data manipulation options, allows the tuner to quickly edit table data on the fly.

The feature is available when connected to an ECU via USB or when playing back logged data.

To turn on, with either a 1D/2DTable or 2D/3DGraph as the active control hit CTRL + F. When activated, the follow will be set to all table type controls for the given item, and those controls will have a "-- (Follow ECU)" in their title bar.

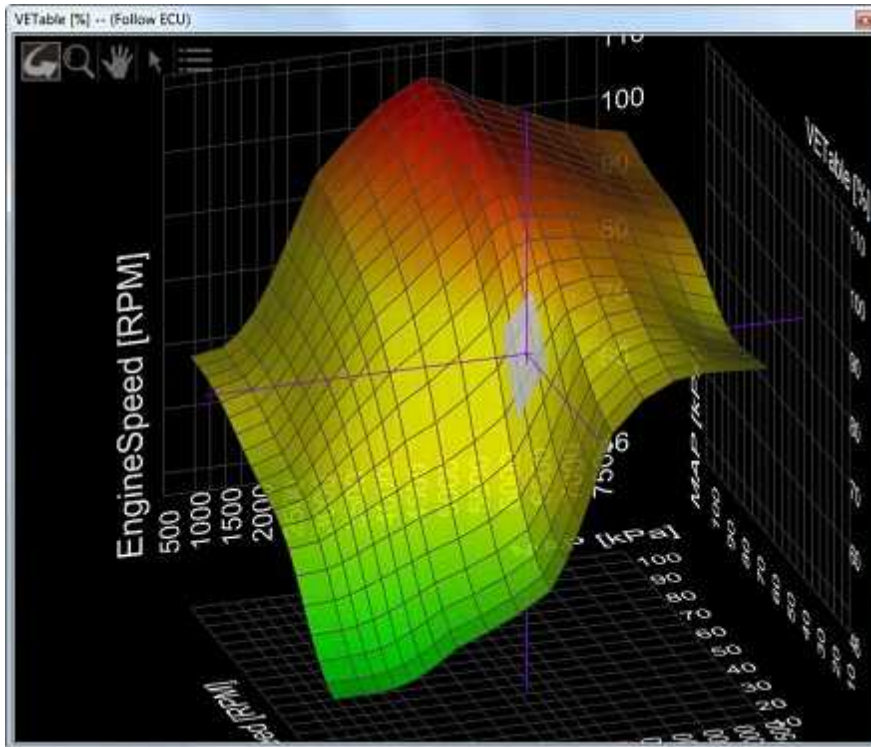

There is a user preference for the number of cells highlighted when in this mode. It can be found in File>Application Options under the main tab.

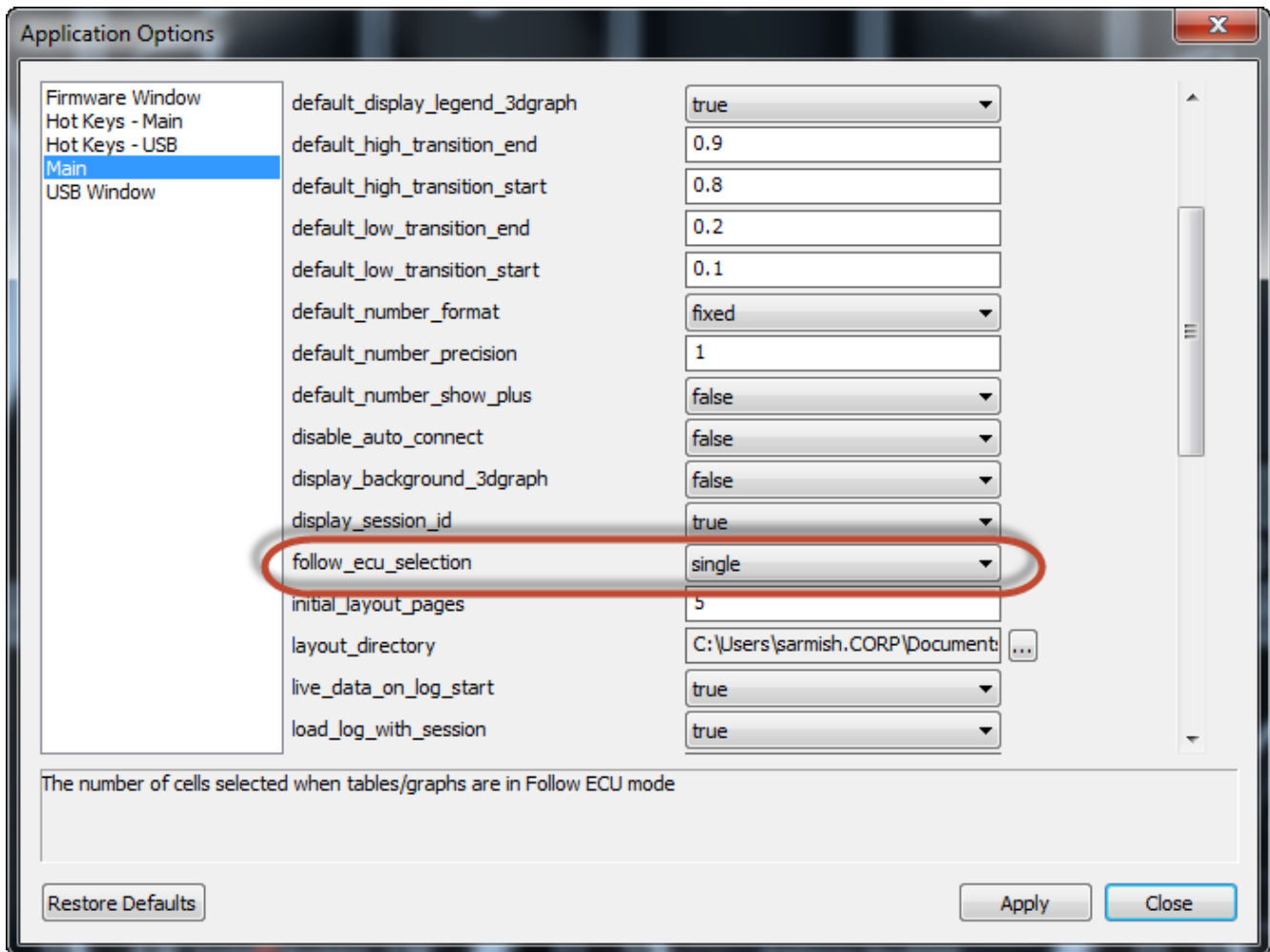

Modified Values

Calibration table changes that haven't been committed to flash memory are highlighted as shown below. Conditions that will reset the display are as follows:

1. Manually committing changes through the Target > Commit modifications menu command
2. Manually committing changes using the hot key combination [Ctrl Shift C]
3. Opening and closing the Setup Wizard. Note the Setup Wizard automatically commits ALL changes to memory every time it is closed.
4. Turning the ignition switch off when the tuning preference Key Off Commit is selected

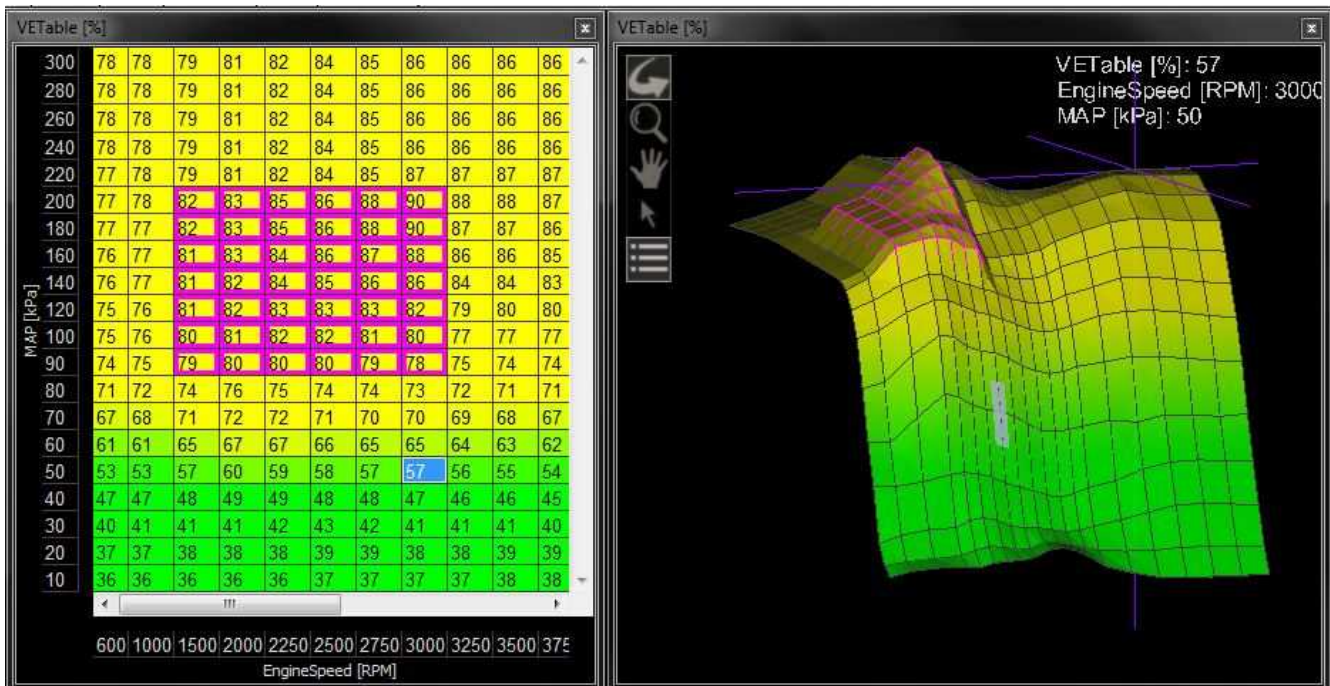

Right Click Editing

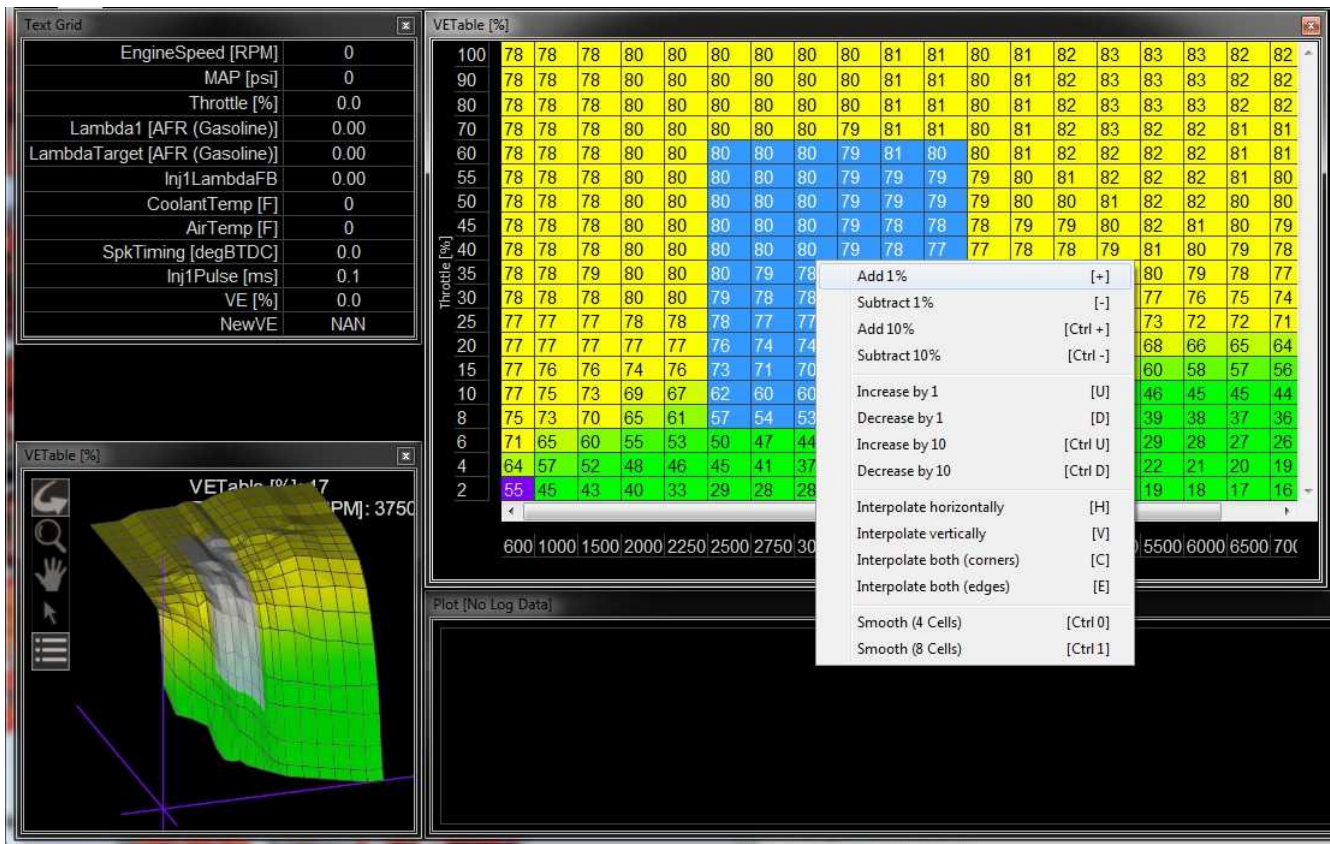

To use the right click menu for editing table values, select a portion of the table and right click. Choose from available options.

Engine Start

There are several tables and options that affect starting the engine.

CrankVE_Table

Units: kPA vs RPM vs VE%

Description: This table sets the percentage of volumetric efficiency to be supplied to the engine at various loads and engine speeds. This applies only while cranking the engine and does not apply after the engine has reached idle speeds.



The screenshot shows a window titled "CrankVE_Table [%]" with a table of values. The vertical axis is labeled "MAP [kPa]" with values 100, 90, 80, 70, and 60. The horizontal axis is labeled "EngineSpeed [RPM]" with values 50, 100, 150, 200, and 250. All cells in the table contain the value "70.0". The cell at the intersection of MAP=60 and EngineSpeed=50 is highlighted in blue.

MAP [kPa]	50	100	150	200	250
100	70.0	70.0	70.0	70.0	70.0
90	70.0	70.0	70.0	70.0	70.0
80	70.0	70.0	70.0	70.0	70.0
70	70.0	70.0	70.0	70.0	70.0
60	70.0	70.0	70.0	70.0	70.0

LambdaAfterStartTrim

Units: Coolant Temp vs After Start Time vs Lambda Offset

Description: This table adds an lambda offset from the LambdaTargetTable as soon as the engine is started. By allowing a slightly richer mixture target, it will keep the engine sound and the lambda correction to a minimum. The AfterStartTime (X-Axis) breakpoints can be adjusted for a specific timeframe. Note: It is not a good idea to have anything but a 0 in the last X-axis cell where the engine is fully warmed up and above. This would add a lambda target offset all the time.

CoolantTemp [C]	1.0	5.0	10.0	15.0	20.0
120.0	-0.075	-0.050	-0.025	-0.025	0.000
100.0	-0.075	-0.050	-0.025	-0.025	0.000
80.0	-0.075	-0.050	-0.025	-0.025	0.000
60.0	-0.075	-0.050	-0.025	-0.025	0.000
40.0	-0.075	-0.075	-0.050	-0.025	-0.025
20.0	-0.075	-0.075	-0.075	-0.050	-0.050
0.0	-0.075	-0.075	-0.075	-0.050	-0.050
-20.0	-0.075	-0.075	-0.075	-0.050	-0.050

FuelTrim Coolant

Units: Coolant Temp vs After Start Time vs Fuel Trim

Description: As opposed to the LambdaAfterStartTrim that trims the target lambda, this table applies a fuel trim as a percentage multiplier where a value of 5.0 would add 5 % to the fuel pulse calculation.

CoolantTemp [C]	1.000	5.000	10.000	15.000	20.000
120.0	2.0	0.0	0.0	0.0	0.0
100.0	2.0	2.0	0.0	0.0	0.0
80.0	3.0	2.0	1.0	0.0	0.0
60.0	4.0	4.0	3.0	3.0	0.0
40.0	4.0	4.0	3.0	3.0	0.0
20.0	5.0	4.0	3.0	3.0	0.0
0.0	5.0	4.0	3.0	3.0	0.0
-20.0	5.0	4.0	3.0	3.0	0.0

LambdaCrankingTable

Units: Lambda Offset vs Coolant Temp

Description: This table allows for the Lambda to be offset when cranking the engine. By allowing a slightly richer mixture this will keep the engine and the lambda correction sound.

LambdaCrankingTable														
0.20	0.20	0.20	0.20	0.20	0.26	0.33	0.49	0.63	0.70	0.70	0.70	0.70	0.70	0.70
-20.0	-10.0	0.0	10.0	20.0	30.0	40.0	50.0	60.0	70.0	80.0	90.0	100.0	110.0	120.0
CoolantTemp [C]														

Idle Air Control

The following tables and options affect the basic functions of the idle air control strategy. Please see the [Idle - Advanced](#) ¹⁶³ section for more details.

IdleTargetTable

Units: Coolant Temp vs Idle Target [RPM]

Description: This is first step in the idle calculation. This table sets the desired Engine Speed for idling, depending on coolant temperature. For most vehicles, the desired idle target will be increased when coolant temperature is low.

IdleTargetTable [RPM]										
1400	1400	1400	1400	1100	1000	1000	1000	1000	1000	0
-20.0	0.0	20.0	40.0	60.0	70.0	80.0	90.0	100.0	110.0	120.0
CoolantTemp [C]										

IdleBasePosition

Units: Coolant Temp vs Idle Position %

Description: This is the second* step in the idle calculation. Depending on the desired Idle Target RPM, this table sets the initial open loop idle position that will be used to reach the desired idle RPM. This happens before any closed-loop idle feedback.

IdleBasePosition										
7	13	21	30	37	45	51	54	56	56	56
800	900	1000	1100	1200	1300	1400	1500	1600	1800	2000
IdleTarget [RPM]										

(* In addition to the IdleTargetTable, there are actually a few other factors that help determine IdleTarget [RPM]. Please see the [Idle - Advanced](#) ¹⁶³ section for more details.)

IdleFB_Active

This is the third step in the idle calculation. If the engine speed and throttle position meet certain conditions, this channel will turn on and the ECU will use closed-loop idle feedback to try and get the engine speed closer to the idle target RPM.

IdleFB

Units: Idle Position %

This is the fourth step in the idle calculation. When IdleFB_Active is on, the ECU will check the difference between the desired **IdleTarget [RPM]** and the measured **EngineSpeed [RPM]**. If the measured engine speed is not close enough to the desired idle RPM, the ECU will try to adjust the amount of idle airflow to adjust EngineSpeed. The amount of closed-loop feedback that is currently being used to adjust airflow gets calculated by the ECU and is displayed as this value, **IdleFB**.

Idle Setup: Stepper Idle Valves

(For 2-wire PWM idle valves, or drive-by-wire vehicles, please skip ahead to the [Idle Basic Setup](#) section.)

When working with a 4-wire or 6-wire stepper idle valve, it is necessary for the ECU to know the correct value for **Idle Stepper max steps** before adjusting any other idle settings. The ECU can never measure a stepper valve's actual position, it can only command that the valve take steps up or steps down and remember how many steps have been commanded. To operate a stepper valve correctly, the ECU must know the maximum number of steps that can be commanded before hitting the mechanical stop. Please follow the instructions below to determine the correct value for **Idle Stepper Max Steps** on an unknown idle stepper motor.

1. With the engine off, remove accessory components as needed so the stepper valve's plunger is visible and it is possible to hear the sound of the stepper valve hitting its mechanical stop. Note that some setups use the engine's intake manifold or throttle body for the mechanical stop; when working with these setups, the stepper valve must remain connected to the mechanical stop.
2. Without changing the **Idle Max Position**, disable feedback by setting the **Idle Feedback Min** and **Idle Feedback Max** to 0%.
3. Set the **IdleBasePosition** to zero.
4. Press [CTRL+U] to increase the IdleBasePosition value one percent at a time, from 0 to 100. If you hear the idle valve hit the mechanical stop before the table value is 100, your **Idle Max Position** is too high. If you do not hear the idle valve hit the mechanical stop, the **Idle Max Position** may be too low.
5. Increase the **Idle Max Position** value by one.
6. Reset the ECU (so it will park the idle valve).
7. Repeat the test again. The goal is to use most of the stepper's possible range without letting the valve hit the stop.

Idle Basic Setup:

The next step before tuning the idle system is to determine the direction of the motor. The ECU displays the channel **Idle Position**, which is 0–100 percent. For some vehicles, increasing the **Idle Position** will decrease the airflow to the engine, and it's important for the ECU to be aware if this is the case. It is very easy to determine which way your specific idle valve works.

1. Open **Infinity Tuner** and connect to the ECU.
2. Confirm the **Throttle** is set properly and the ECU's Throttle channel increases from 0% as soon as the throttle is pressed without any 'dead spots'.
3. Open the **Idle Wizard** and set **Idle On Below TPS** to 10%.
4. Initially set the **Idle On Below RPM** to 3000RPM.
5. Set the option **Idle Feedback Min** to -50%, and **Idle Feedback Max** to 50%.
6. Open the **Idle Tab** and set the entire **IdleTargetTable** to 2000 RPM.
7. Temporarily set the entire **IdleBasePosition** table to 50.

These settings will allow idle feedback whenever the engine RPM is below 3000RPM and the throttle is below 10%. These settings are not intended to be used after the setup process is completed, but they should allow the feedback to help the vehicle stay running without holding the throttle so you can begin tuning the idle base tables.

8. Start the engine and get it to idle. This may require creative throttle movements to stabilize the idle until it catches itself.
9. Confirm **Lambda** is measuring safe values, so the vehicle has sufficient fuel to idle without stalling but is not running so rich it will foul spark plugs.
10. Make sure that **Engine Speed** is less than 3000RPM. If not, there may be a vacuum leak.
11. Be sure the throttle pedal is at rest and confirm the ECU's measured **Throttle** value displays less than **10%**.
12. Confirm that an increase in the **IdleBasePosition** values will increase engine speed.
13. If RPM decreases when IdleBasePosition increases, change the **Idle Airflow Invert** option in the **Idle Wizard**.

Idle Basic Tuning:

1. After the engine gets up to operating temperature, confirm that the **IdleTarget** displays 2000RPM.
2. Add or subtract idle values from the **IdleBasePosition** table until the **IdleFB** channel displays between -3% and -8%. Note: If the idle motor does not allow enough airflow to reach 2000 RPM, try some lower target RPM that can be achieved.
3. Change the **IdleTargetTable** to 1800RPM.
4. Add or subtract idle percent for the 1800 RPM cell in the **IdleBasePosition** table until the **IdleFB** channel parameter is between -3% and -8%.
5. Change the target value in the **IdleTargetTable** to 1600RPM.
6. Repeat steps 4–5, adjusting the values in the IdleBasePosition table until the lowest desired idle RPM.

Now the **IdleTargetTable** can be set to your desired values for normal operation. Many tuners increase the idle target by 200–400 RPM when the engine is cold for increased idle stability and to help the engine warm up more quickly.

It is recommended to set the **Idle On Below TPS** option to 2–3% higher than the ECU's measured **Throttle** position when the engine is running and the throttle is at rest. This will allow for minor fluctuations in the throttle signal without disabling idle feedback.

Typical values for **Idle On Below RPM** are 1500–2000 RPM, so the feedback will be active at high idle target RPM when coolant temperatures are low, but idle feedback is not active when the engine is in gear and decelerating.

Some tuners prefer to set the **Idle Feedback Min** to a smaller value than the **Idle Feedback Max** to limit the amount of negative feedback that can be accumulated in situations where idle feedback is active but some external factor is limiting the engine's response to idle feedback. An example is when the vehicle is decelerating in gear with the clutch engaged, the vehicle's drivetrain may prevent the engine from reaching the idle target RPM and idle feedback will continue to accumulate. When the clutch becomes disengaged the drivetrain gets removed from the equation, and the engine speed will fall quickly if a lot of negative feedback has been accumulated. Another way to alleviate this would be to decrease the value for **Idle On Below RPM**. See the [Idle](#) ¹⁶¹ section of the wizard for more info.

VE & Airflow Based Tuning

The Infinity ECU uses significantly different methods of calculating the fuel delivery requirements and outputs than previous AEM products.

Measured data from sensors, i.e., Manifold Absolute Pressure (MAP [kPa]), Air Temperature, Coolant Temperature, and Engine RPM, are acquired. The ECU uses this sensor data in combination with Volumetric

Efficiency (VE%) to estimate airflow.

The Volumetric Efficiency is a percentage of air and fuel that actually enters the cylinder during induction relative to the volumetric capacity (rated displacement) of the cylinder under static conditions. The VE lookup table is a 2-axis lookup table, with load values (typically MAP [kPa]) versus Engine RPM. In each table cell, the Engine RPM corresponds with a specific MAP [kPa], and a Volumetric Efficiency is defined for that cell.

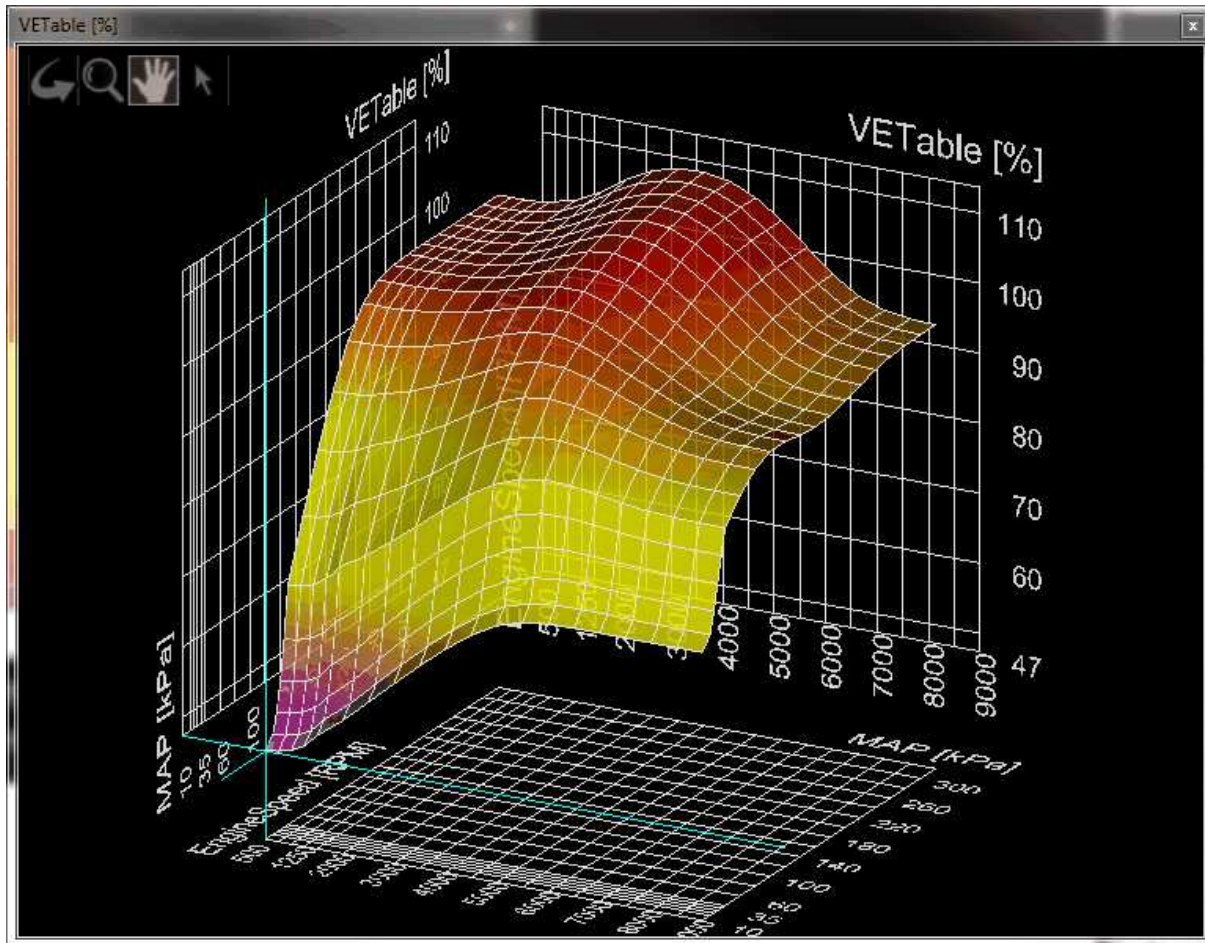

The Volumetric Efficiency is combined with temperature sensor data to estimate a compensated Mass Airflow. The ChargeTempBlend table dictates what ratio of air temperature to coolant temperature is used at specific Engine RPM to adjust the density of the inducted air. A higher number gives priority to Coolant Temperature, and is seen at lower Engine RPM.



Once Mass Airflow has been calculated using the tables above, the Infinity ECU will look up the Target Lambda (AFR) and then calculate the fuel requirements. Target AFR will be used as a main parameter in determining fuel injector flow rate. The LambdaTargetTable (below Left) and AFR Target Table conversion table (below Right) will have default values. Based on the calculated Mass Airflow, the Infinity ECU will attempt to add enough fuel to hit

the target AFR.

Note: The calculated LambdaTarget influences the fuel delivered to the engine at all times, even when closed-loop O2 feedback is disabled.

220	0.750	0.750	0.750	0.750	0.750	0.750	0.750	0.750	0.750	0.750
200	0.750	0.750	0.750	0.750	0.750	0.750	0.750	0.750	0.750	0.750
175	0.750	0.750	0.750	0.750	0.750	0.750	0.750	0.750	0.750	0.750
150	0.750	0.750	0.750	0.750	0.750	0.750	0.750	0.750	0.750	0.750
125	0.750	0.750	0.750	0.750	0.750	0.750	0.750	0.750	0.750	0.750
100	0.850	0.850	0.850	0.850	0.850	0.850	0.850	0.850	0.850	0.850
80	0.920	0.920	0.940	0.990	0.990	0.990	0.920	0.920	0.920	0.920
60	0.950	0.950	0.980	0.990	0.990	0.990	0.920	0.920	0.920	0.920
40	0.980	0.980	0.980	0.990	0.990	0.990	0.920	0.920	0.920	0.920
30	0.980	0.980	0.980	0.990	0.990	0.990	0.920	0.920	0.920	0.920

MAP [kPa]

EngineSpeed [RPM]

17	10.95	10.95	10.95	10.95	10.95	10.95	10.95	10.95	10.95	10.95
14	10.95	10.95	10.95	10.95	10.95	10.95	10.95	10.95	10.95	10.95
11	10.95	10.95	10.95	10.95	10.95	10.95	10.95	10.95	10.95	10.95
7	10.95	10.95	10.95	10.95	10.95	10.95	10.95	10.95	10.95	10.95
3	10.95	10.95	10.95	10.95	10.95	10.95	10.95	10.95	10.95	10.95
-0	12.41	12.41	12.41	12.41	12.41	12.41	12.41	12.41	12.41	12.41
-3	13.43	13.43	13.72	14.45	14.45	14.45	13.43	13.43	13.43	13.43
-6	13.87	13.87	14.31	14.45	14.45	14.45	13.43	13.43	13.43	13.43
-9	14.31	14.31	14.31	14.45	14.45	14.45	13.43	13.43	13.43	13.43
-10	14.31	14.31	14.31	14.45	14.45	14.45	13.43	13.43	13.43	13.43

MAP [PSIG]

EngineSpeed [RPM]

The suggested tuning method is to set the AFR using the LambdaTargetTable or AFR Target Table to a value safe and suitable for the engine. For normally aspirated engines a value of 13.0:1 or 0.887 lambda is usually sufficient at all operating conditions. For boosted applications, the operating conditions dictate a safe AFR. Please consult a tuner knowledgeable in your engine's requirements for help. Once the target lambda (AFR) values are chosen, run the engine at as many operating conditions as possible and adjust the VE Table to reach the AFR Target Table

values. Once the VE Table has been tuned to accurately reach the AFR Target Table values at all operating ranges, then you can change the AFR Target Table to use different AFR settings later. Never adjust VETable to run a different AFR, only to achieve the LambdaTarget value.

The Injector Flowrate is very important in determining the fuel requirements. The Infinity ECU uses actual Injector Flowrate [cc/min] to determine the proper injector pulse width. The InjFlowRate [cc/min] table is calibrated from the Setup Wizard: Injector Flow, however the table can be modified manually for unlisted injectors.

499.8	499.8	499.8	499.8	499.8	499.8
20.0	40.0	50.0	60.0	80.0	100.0
InjPressure [psig]					

Now that the base injector flow rate has been determined, the Infinity ECU applies a few more compensating factors. Wall Wetting is a function of fuel condensing in the intake manifold at the injection point. At different rates of change in the MAP [kPa] values, and at different Coolant Temperatures, fuel enrichment compensations are used to prevent lean and rich conditions during rapid manifold pressure changes. Note that this table has several different functions. It can be used for dynamic transients by nature of its "MAP Rate" x-axis. It can also be used for more steady state compensations by adjusting the values in the "middle band" of the table where MAP rate changes are very small. Positive numbers in this table will effectively add fuel to enrich the mixture. Negative numbers have the opposite effect.

100.0	0.0	0.0	0.0	0.0	0.0	0.0	5.0	10.0	15.5	15.5
80.0	0.0	0.0	0.0	0.0	0.0	0.0	5.0	10.0	15.5	15.5
60.0	0.0	0.0	0.0	0.0	0.0	0.0	5.0	10.0	15.5	15.5
40.0	0.0	0.0	0.0	0.0	0.0	0.0	7.5	15.0	23.5	23.5
20.0	0.0	0.0	0.0	0.0	0.0	0.0	10.0	20.0	31.0	31.0
0.0	0.0	0.0	0.0	0.0	0.0	0.0	10.0	20.0	31.0	31.0
-20.0	0.0	0.0	0.0	0.0	0.0	0.0	10.0	20.0	31.0	31.0
Coolant Temp [C]										
-500.0 -200.0 -100.0 0.0 25.0 50.0 100.0 200.0 300.0 500.0										
Throttle Rate										

The X and Y axis inputs of the WallWetting table can be set to several different variables. These settings are found in the Setup Wizard page for Accel and Decel Fuel. Axis selections include:

- Map Rate
- Throttle Rate
- Coolant Temp
- MAP [kPa]
- EngineSpeed [RPM]
- DBW_APP Rate

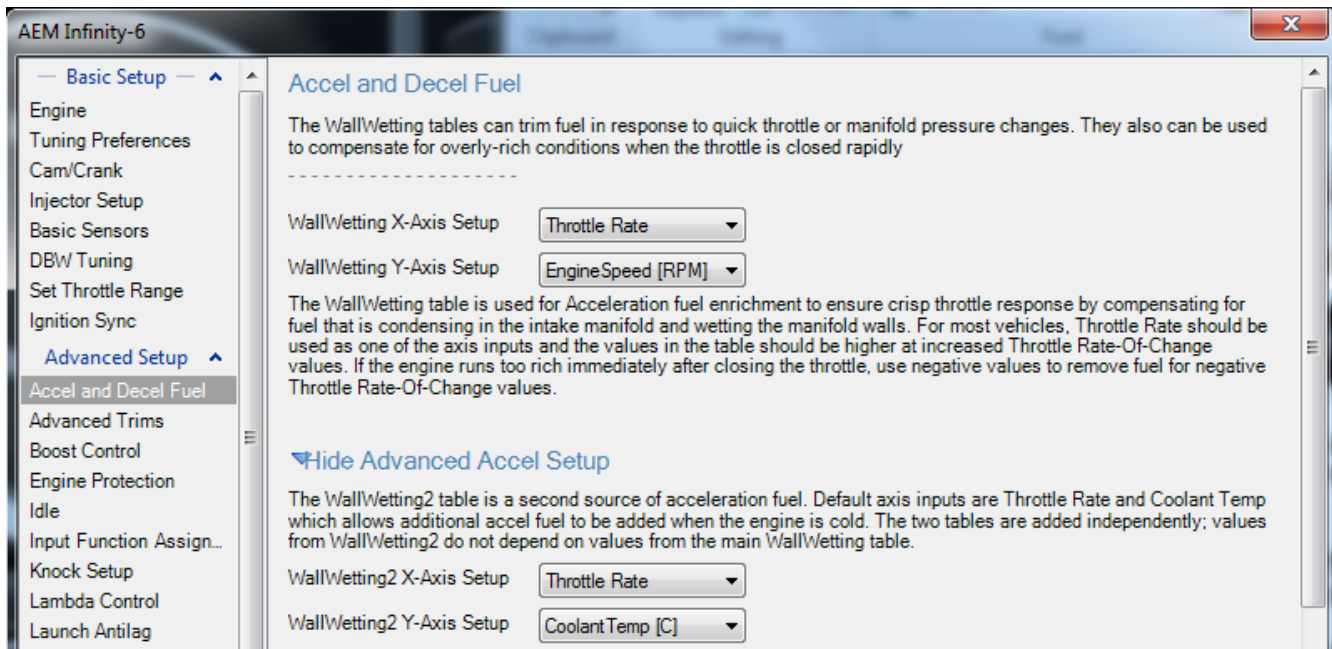

LambdaAfterStartTrim is a 2-axis table that is used to modify the Lambda (AFR) for specified time after starting the engine. This table adds a lambda offset for a small period of time after the engine is started. By allowing a slightly richer mixture target, it will keep the engine from stalling or running rough immediately after starting and the lambda correction to a minimum. The last column should be populated with "0" trim at operating temperatures to prevent a continuous lambda offset.

CoolantTemp [C]	1.0	5.0	10.0	15.0	20.0
120.0	-0.075	-0.050	-0.025	-0.025	0.000
100.0	-0.075	-0.050	-0.025	-0.025	0.000
80.0	-0.075	-0.050	-0.025	-0.025	0.000
60.0	-0.075	-0.050	-0.025	-0.025	0.000
40.0	-0.075	-0.075	-0.050	-0.025	-0.025
20.0	-0.075	-0.075	-0.075	-0.050	-0.050
0.0	-0.075	-0.075	-0.075	-0.050	-0.050
-20.0	-0.075	-0.075	-0.075	-0.050	-0.050

Target Lambda

To control the engine's fuel delivery system, the Infinity can be programmed to run open loop and/or closed loop O2 feedback. Closed loop uses feedback from the oxygen sensor to make temporary, but immediate, corrections to the injection to maintain a target air fuel ratio (AFR) or lambda. The type of the O2 sensor will determine how lambda target can be controlled. Due to the nature of standard narrow band O2 sensors, the only accurate measurement that can be maintained in closed loop is Lambda 1.0. However, wideband O2 sensors can be used in almost every feedback condition.

Note that 14.64:1 is called the stoichiometric AFR for gasoline. It is the ratio where all available fuel is burned completely. For most performance applications, it is not the ideal AFR to operate the engine at all the time nor is it the AFR that creates the most power or even economy under all conditions.

When the fuel system is open loop, the O2 sensor is ignored and the injector pulse width relies on the VE Table and fuel compensators to adjust injection duration. Open loop is necessary during engine starts, when the O2 sensor has cooled below its operating temperature. It may also be necessary when coolant temperatures are low. In this state, the fuel vaporization is poor and the engine will require a richer mixture to properly operate. When under heavy load, the engine typically requires an air fuel ratio that is out of a narrow band oxygen sensor's standard range and open loop will be necessary. When the accelairflow function is triggered during hard accelerations, open loop may be necessary to help stabilize the Target Lambda. Also, when the deceleration function cuts fuel completely, target lambda will not be necessary.

LambaTargetTable

Units: Engine Load vs Engine Speed vs Lambda

Description: This table sets the target lambda for various engine conditions.

220.0	0.710	0.710	0.710	0.710	0.710	0.710	0.710	0.710	0.710	0.710
200.0	0.710	0.710	0.710	0.710	0.710	0.710	0.710	0.710	0.710	0.710
175.0	0.710	0.710	0.710	0.710	0.710	0.710	0.710	0.710	0.710	0.710
150.0	0.710	0.710	0.710	0.710	0.710	0.710	0.710	0.710	0.710	0.710
125.0	0.710	0.710	0.710	0.710	0.710	0.710	0.710	0.710	0.710	0.710
100.0	0.820	0.820	0.820	0.820	0.820	0.820	0.820	0.820	0.820	0.820
80.0	0.990	0.990	0.990	0.990	0.990	0.990	0.990	0.990	0.990	0.990
60.0	0.940	0.940	0.940	0.980	0.950	0.940	0.940	0.940	0.940	0.940
40.0	0.940	0.940	0.940	0.980	0.950	0.940	0.940	0.940	0.940	0.940
30.0	0.940	0.940	0.940	0.980	0.950	0.940	0.940	0.940	0.940	0.940
	500	1000	2000	3000	4000	5000	6000	7000	8000	9000

EngineSpeed [RPM]

Tuning Target Lambda

The first step before tuning:

1. Open **Infinity Tuner** and connect to the ECU.
2. Open the **Lambda Tab** and confirm the **Lambda1Cal Table** is set up for the oxygen sensor used.
3. Open the **Lambda Control Wizard** and check the **Lambda 1 Feedback Enable** and/or **Lambda Feedback Enable** boxes.
4. Set the **Lambda Feedback Max Speed**. Wideband O2 sensors are accurate in most situations so this can be activated all the time, if need be.
5. Set the **Lambda Feedback After Start Delay** (typical -10 seconds).

The Infinity Tuner functions are located in the **TargetLambda** tab.

1. Use the **Lambda Control Proportional Gain** by itself and set the **Lambda Control Integral Gain** and

Lambda Control Derivative Gain to zero.

2. Log the channels **Lambda1** (or 2) and **ErrorLambda1** (or 2).
3. Increase the **Lambda Control Proportional Gain** until the point of instability or a sustained oscillation is reached.
4. From here, the ultimate proportional (K_u) is found.
5. From the log, measure the period of oscillation from peak to peak, in seconds, to obtain the critical time constant or ultimate period (P_u).
6. Once the values for K_u and P_u are obtained, the PID parameters can be calculated from the following equations.

Proportional, Integral, and Derivative Feedback

Lambda Control Proportional Gain = 0.60 (K_u)

Lambda Control Integral Gain = 2 (K_p) / P_u

Lambda Control Derivative Gain = (K_p)(P_u) / 8

Note that these values are not optimal values and additional fine tuning may be required to obtain the best target lambda performance.

Lambda Control Tuning

When an O2 sensor is connected directly to the Infinity ECU, the ECU can use closed-loop feedback to react to changes in the engine's fuel delivery requirements, or to compensate for sections of the VETable that could still benefit from additional tuning. When Lambda feedback is active, the ECU compares the desired **LambdaTarget** value against the measured **Lambda1** value from the O2 sensor and then adjusts the fuel trim for each injector in an attempt to bring the measured value closer to the target value.

O2 Sensor Assignment:

Before enabling closed-loop lambda feedback, use the [Injector Setup](#)^[90] page in the wizard to assign each fuel injector's feedback to use the Lambda1 or Lambda2 sensor. For most simple 4-cylinder engines, all four injectors will be assigned to use the same O2 sensor for feedback. A more complex example would be a GM LS1 engine with two O2 sensors; each sensor should be installed in the exhaust collector for each bank of cylinders. The left bank of cylinders (1,3,5,7) should be assigned to one Lambda sensor and the right bank of cylinders (2,4,6,8) should be assigned to the other Lambda sensor. This allows the ECU to trim each bank of injectors independently based on each of the two Lambda sensors. Before enabling feedback using multiple O2 sensors, test that the Lambda1 / Lambda2 sensor assignment is correct for each injector by adjusting the values in the injector fuel trim tables (Inj1FuelTrimTable [%]) and confirming that the appropriate sensor indicates a change in measured AFR.

Lambda Target Trims:

Aside from the main LambdaTargetTable, there are a few other functions that can alter the target lambda value:

LambdaAfterStartTrim:

LambdaAfterStartTrim is a 2D table that allows the ECU to target a richer mixture for some time after the engine is started, or when the engine is cold. See the [Engine Start](#)^[116] section for more details.

LambdaTrimN2O:

LambdaTrimN2O is calculated by the ECU's Nitrous control function, to modify the target lambda value when nitrous is active. See [Nitrous N2O](#)^[210] for more details.

LambdaTrim_Knock is calculated by the ECU's Knock Control function, to modify the target lambda value in response to knock sensor activity. See [Knock Control](#)^[199] for more details.

In addition to these lambda trims, the ECU can switch between multiple Lambda Target maps. See [Multi-Map Features](#)^[241] for more details.

Lambda Feedback Activation:

Use the wizard to configure the conditions that allow Lambda feedback to be activated. See [Lambda Control](#)^[202] for details.

Please also note that there are some conditions that will cause Lambda Feedback to be disabled, such as DecelFuelCut or rev limiters (including the 2 Step limiter, 3step limiter and any fuel/spark cuts calculated by Traction Control). The ECU's channel **LambdaFB_Disabled** can be viewed or datalogged to see if feedback is disabled. After lambda feedback has been disabled, the activation conditions must be met for 750ms before lambda feedback will turn back on.

Lambda Feedback tuning:

The ECU uses PID feedback to make fuel corrections based on the measured lambda signal. When tuning the PID gains, it helps to understand how the O2 sensor measures the oxygen content of the exhaust gas. The sensing element is protected by a metal shield, and this shield has small holes which allow exhaust gas to flow across the sensing element. At low engine speeds, exhaust gas travels relatively slowly so the sensor will take more time to detect the air/fuel ratio of the exhaust. The sensor's distance from the exhaust ports is also a factor in response time. The sensor response time for your setup can be observed by datalogging the fuel injector pulsewidth **Inj1Pulse [ms]** and the **Lambda1** signal, then making a large change to the values in the **VETable** or **LambdaTargetTable**. Observe how the sensor's response time will be faster at higher RPM, especially at higher engine loads. Because of this slight delay in detecting the oxygen content of the engine's exhaust, Lambda feedback gains must be set to lower values at low RPM. If the feedback gains are too high at idle, the feedback will make corrections more quickly than the sensor can measure O2 changes in the exhaust and the engine RPM may 'hunt' due to fluctuating air/fuel ratios. At high engine speeds, the sensor detects changes in exhaust air/fuel ratio more quickly so the Lambda feedback gains should be increased for quicker feedback response.

LambdaFB Gain Tables**Units:** Gain vs RPM

Description: These table set the feedback's Proportional and Integral gain as a function of Engine Speed. Integral control uses an integrator or 'accumulator' method, essentially checking if the Lambda target error is positive or negative and then taking one step up or one step down every 10ms to reduce the target error. The advantage of integral response for Lambda control is the fuel trim will be smoothly adjusted until the measured Lambda value reaches the target, and then remain at whatever feedback value reached the target. Note: Although Integral gain is less likely to cause hunting or fluctuations than Proportional, excessively high Integral values will take steps that are too large which can result in instability.

Min value = 0.000, Max value = 6.375

AEM Infinity-6

Basic Setup

Engine
Tuning Preferences
Cam/Crank
Injector Setup
Basic Sensors
DBW Tuning
Set Throttle Range
Ignition Sync

Advanced Setup

Accel and Decel Fuel
Advanced Trims
Boost Control
Engine Protection
Idle
Input Function Assignments
Knock Setup
Lambda Control
Launch Antilag
Launch Timer
Nitrous N2O
Main Rev Limiter
Rev Limit 2 Step
Rev Limit 3 Step
Shift Cut
Traction Control
USB Logging
WC
Diagnostics

Outputs

Lambda Feedback Min Speed: 800 rpm
Lambda Feedback Max Speed: 10000 rpm
Lambda Feedback Min Load: 5 kPa
Lambda Feedback Max Load: 700 kPa

Hide LambdaFB_P Table Setup

EngineSpeed [RPM]	Lambda Feedback P Value []
1500	0.050
2000	0.100
3000	0.100
4000	0.100
5000	0.100
6000	0.100

Hide LambdaFB_I Table Setup

EngineSpeed [RPM]	Lambda Feedback I Value []
1500	0.300
2000	1.200
3000	2.200
4000	2.200
5000	2.200
6000	2.200

Hide Advanced Setup

Lambda Feedback Proportional and Feedback Integral Gain must be adjusted using the 1D tables 'LambdaFB_P' and 'LambdaFB_I'. The gain can be adjusted per RPM

Lambda Feedback Derivative Gain: 0.005

Fuel Trims

WallWetting

Units: Throttle Rate vs EngineSpeed vs MassAirflow Adder

Description: This table adds additional fuel enrichment for acceleration conditions. This is mostly used to help the engine accelerate well and avoid a lean condition that can occur when the throttle is opened quickly at low RPM.

EngineSpeed [RPM]	-500	-200	-100	0	25	50	100	200	300	500
7000	0.0	0.0	0.0	0.0	0.0	0.0	5.0	10.0	15.5	15.5
6000	0.0	0.0	0.0	0.0	0.0	0.0	5.0	10.0	15.5	15.5
5000	0.0	0.0	0.0	0.0	0.0	0.0	5.0	10.0	15.5	15.5
4000	0.0	0.0	0.0	0.0	0.0	0.0	7.5	15.0	23.5	23.5
3000	0.0	0.0	0.0	0.0	0.0	0.0	10.0	20.0	31.0	31.0
2000	0.0	0.0	0.0	0.0	0.0	0.0	10.0	20.0	31.0	31.0
1000	0.0	0.0	0.0	0.0	0.0	0.0	10.0	20.0	31.0	31.0

WallWetting2

Units: Throttle Rate vs CoolantTemp vs MassAirflow Adder

Description: This table adds additional fuel enrichment for acceleration conditions when the engine is cold. Both tables (WallWetting and WallWetting2) are added together.

CoolantTemp [C]	-500	-200	-100	0	25	50	100	200	300	500
120	0.0	0.0	0.0	0.0	0.0	0.0	0.0	0.0	0.0	0.0
100	0.0	0.0	0.0	0.0	0.0	0.0	0.0	0.0	0.0	0.0
80	0.0	0.0	0.0	0.0	0.0	0.0	0.0	0.0	0.0	0.0
60	0.0	0.0	0.0	0.0	0.0	0.0	0.0	0.0	0.0	0.0
40	0.0	0.0	0.0	0.0	0.0	0.0	0.0	5.0	7.0	9.0
20	0.0	0.0	0.0	0.0	0.0	0.0	0.0	5.0	7.0	9.0
0	0.0	0.0	0.0	0.0	0.0	0.0	0.0	5.0	7.0	9.0

The output of each wall wetting table is added together. This effectively adds another tuning variable dimension since the y-axis of each table does not need to match. For example if compensation is required as a function of engine speed, throttle rate AND coolant temperature, the tables can be configured as above to satisfy the tuning requirements.

FuelTrim_1 [%]

Units: EngineSpeed vs MAP vs Fuel Trim

Description: This table is a generic 2-axis fuel trim. Most common usage is to add fuel or remove fuel when Manifold Pressure is high, especially if using Throttle for the VETable Load Axis selection.

MAP [kPa]	500	750	1000	1250	1500	2000	2500	3000	3500	4000	4500	5000	5500	6000	6500	7000	7500	8000	8500	9000
320	0.0	0.0	0.0	0.0	0.0	0.0	0.0	0.0	0.0	0.0	0.0	0.0	0.0	0.0	0.0	0.0	0.0	0.0	0.0	0.0
300	0.0	0.0	0.0	0.0	0.0	0.0	0.0	0.0	0.0	0.0	0.0	0.0	0.0	0.0	0.0	0.0	0.0	0.0	0.0	0.0
280	0.0	0.0	0.0	0.0	0.0	0.0	0.0	0.0	0.0	0.0	0.0	0.0	0.0	0.0	0.0	0.0	0.0	0.0	0.0	0.0
260	0.0	0.0	0.0	0.0	0.0	0.0	0.0	0.0	0.0	0.0	0.0	0.0	0.0	0.0	0.0	0.0	0.0	0.0	0.0	0.0
240	0.0	0.0	0.0	0.0	0.0	0.0	0.0	0.0	0.0	0.0	0.0	0.0	0.0	0.0	0.0	0.0	0.0	0.0	0.0	0.0
220	0.0	0.0	0.0	0.0	0.0	0.0	0.0	0.0	0.0	0.0	0.0	0.0	0.0	0.0	0.0	0.0	0.0	0.0	0.0	0.0
200	0.0	0.0	0.0	0.0	0.0	0.0	0.0	0.0	0.0	0.0	0.0	0.0	0.0	0.0	0.0	0.0	0.0	0.0	0.0	0.0
180	0.0	0.0	0.0	0.0	0.0	0.0	0.0	0.0	0.0	0.0	0.0	0.0	0.0	0.0	0.0	0.0	0.0	0.0	0.0	0.0
160	0.0	0.0	0.0	0.0	0.0	0.0	0.0	0.0	0.0	0.0	0.0	0.0	0.0	0.0	0.0	0.0	0.0	0.0	0.0	0.0
140	0.0	0.0	0.0	0.0	0.0	0.0	0.0	0.0	0.0	0.0	0.0	0.0	0.0	0.0	0.0	0.0	0.0	0.0	0.0	0.0
120	0.0	0.0	0.0	0.0	0.0	0.0	0.0	0.0	0.0	0.0	0.0	0.0	0.0	0.0	0.0	0.0	0.0	0.0	0.0	0.0
100	0.0	0.0	0.0	0.0	0.0	0.0	0.0	0.0	0.0	0.0	0.0	0.0	0.0	0.0	0.0	0.0	0.0	0.0	0.0	0.0
80	0.0	0.0	0.0	0.0	0.0	0.0	0.0	0.0	0.0	0.0	0.0	0.0	0.0	0.0	0.0	0.0	0.0	0.0	0.0	0.0
60	0.0	0.0	0.0	0.0	0.0	0.0	0.0	0.0	0.0	0.0	0.0	0.0	0.0	0.0	0.0	0.0	0.0	0.0	0.0	0.0
40	0.0	0.0	0.0	0.0	0.0	0.0	0.0	0.0	0.0	0.0	0.0	0.0	0.0	0.0	0.0	0.0	0.0	0.0	0.0	0.0
35	0.0	0.0	0.0	0.0	0.0	0.0	0.0	0.0	0.0	0.0	0.0	0.0	0.0	0.0	0.0	0.0	0.0	0.0	0.0	0.0
30	0.0	0.0	0.0	0.0	0.0	0.0	0.0	0.0	0.0	0.0	0.0	0.0	0.0	0.0	0.0	0.0	0.0	0.0	0.0	0.0
25	0.0	0.0	0.0	0.0	0.0	0.0	0.0	0.0	0.0	0.0	0.0	0.0	0.0	0.0	0.0	0.0	0.0	0.0	0.0	0.0
20	0.0	0.0	0.0	0.0	0.0	0.0	0.0	0.0	0.0	0.0	0.0	0.0	0.0	0.0	0.0	0.0	0.0	0.0	0.0	0.0
10	0.0	0.0	0.0	0.0	0.0	0.0	0.0	0.0	0.0	0.0	0.0	0.0	0.0	0.0	0.0	0.0	0.0	0.0	0.0	0.0

The FuelTrim_1 [%] data can be viewed differently using a conversion channel. If no conversion channel is applied to the data as shown in the example above, the multiplier is applied as follows:

$$\text{Fuel pulse modified} = \text{Fuel pulse} \times (1 + \text{FuelTrim}_1)$$

In this format, a value of 0.100 in the table will result in a 10% addition to the base fuel pulse calculation.

Alternatively, the user can apply a conversion channel.

A conversion channel of the following format will allow the user to view the data in [%] modifications.

Conversion Channel

Name: FuelTrim_1 [%]

Expression: $i0 * 100$

Reverse expression: $i0 / 100$

Input (i0): FuelTrim_1

Set

OK Cancel

When this conversion channel is applied, the data will be represented as follows.

FuelTrim_1 [%]

320	10.000	10.000	8.000	2.000	0.000	0.000	0.000	0.000	0.000	0.000
300	10.000	10.000	8.000	2.000	0.000	0.000	0.000	0.000	0.000	0.000
280	10.000	10.000	8.000	2.000	0.000	0.000	0.000	0.000	0.000	0.000
260	10.000	10.000	8.000	2.000	0.000	0.000	0.000	0.000	0.000	0.000
240	10.000	10.000	8.000	2.000	0.000	0.000	0.000	0.000	0.000	0.000
220	8.000	8.000	6.000	1.000	0.000	0.000	0.000	0.000	0.000	0.000
200	2.000	2.000	1.000	0.000	0.000	-1.000	0.000	0.000	0.000	0.000
180	0.000	0.000	0.000	0.000	-5.000	-6.000	-5.000	0.000	0.000	0.000
160	0.000	0.000	0.000	-1.000	-7.000	-9.000	-7.000	-1.000	0.000	0.000
140	0.000	0.000	0.000	-2.000	-8.000	-10.000	-8.000	-2.000	0.000	0.000
120	0.000	0.000	0.000	-1.000	-7.000	-9.000	-7.000	-1.000	0.000	0.000
100	0.000	0.000	0.000	0.000	-5.000	-6.000	-5.000	0.000	0.000	0.000
80	0.000	0.000	0.000	0.000	0.000	-1.000	0.000	0.000	0.000	0.000
60	0.000	0.000	0.000	0.000	0.000	0.000	0.000	0.000	0.000	0.000

500 750 1000 1250 1500 2000 2500 3000 35

EngineSpeed [RPM]

FuelTrim_2 [%]

Units: EngineSpeed vs MAP vs Fuel Trim

Description: This table is a generic 2-axis fuel trim. Most common usage is to add fuel or remove fuel when Manifold Pressure is high, especially if using Throttle for the VETable Load Axis selection.

FuelTrim_2

320.0	0.0	0.0	0.0	0.0	0.0	0.0	0.0	0.0	0.0	0.0	0.0	0.0	0.0	0.0	0.0	0.0	0.0	0.0	0.0	
300.0	0.0	0.0	0.0	0.0	0.0	0.0	0.0	0.0	0.0	0.0	0.0	0.0	0.0	0.0	0.0	0.0	0.0	0.0	0.0	0.0
280.0	0.0	0.0	0.0	0.0	0.0	0.0	0.0	0.0	0.0	0.0	0.0	0.0	0.0	0.0	0.0	0.0	0.0	0.0	0.0	0.0
260.0	0.0	0.0	0.0	0.0	0.0	0.0	0.0	0.0	0.0	0.0	0.0	0.0	0.0	0.0	0.0	0.0	0.0	0.0	0.0	0.0
240.0	0.0	0.0	0.0	0.0	0.0	0.0	0.0	0.0	0.0	0.0	0.0	0.0	0.0	0.0	0.0	0.0	0.0	0.0	0.0	0.0
220.0	0.0	0.0	0.0	0.0	0.0	0.0	0.0	0.0	0.0	0.0	0.0	0.0	0.0	0.0	0.0	0.0	0.0	0.0	0.0	0.0
200.0	0.0	0.0	0.0	0.0	0.0	0.0	0.0	0.0	0.0	0.0	0.0	0.0	0.0	0.0	0.0	0.0	0.0	0.0	0.0	0.0
180.0	0.0	0.0	0.0	0.0	0.0	0.0	0.0	0.0	0.0	0.0	0.0	0.0	0.0	0.0	0.0	0.0	0.0	0.0	0.0	0.0
160.0	0.0	0.0	0.0	0.0	0.0	0.0	0.0	0.0	0.0	0.0	0.0	0.0	0.0	0.0	0.0	0.0	0.0	0.0	0.0	0.0
140.0	0.0	0.0	0.0	0.0	0.0	0.0	0.0	0.0	0.0	0.0	0.0	0.0	0.0	0.0	0.0	0.0	0.0	0.0	0.0	0.0
120.0	0.0	0.0	0.0	0.0	0.0	0.0	0.0	0.0	0.0	0.0	0.0	0.0	0.0	0.0	0.0	0.0	0.0	0.0	0.0	0.0
100.0	0.0	0.0	0.0	0.0	0.0	0.0	0.0	0.0	0.0	0.0	0.0	0.0	0.0	0.0	0.0	0.0	0.0	0.0	0.0	0.0
80.0	0.0	0.0	0.0	0.0	0.0	0.0	0.0	0.0	0.0	0.0	0.0	0.0	0.0	0.0	0.0	0.0	0.0	0.0	0.0	0.0
60.0	0.0	0.0	0.0	0.0	0.0	0.0	0.0	0.0	0.0	0.0	0.0	0.0	0.0	0.0	0.0	0.0	0.0	0.0	0.0	0.0
40.0	0.0	0.0	0.0	0.0	0.0	0.0	0.0	0.0	0.0	0.0	0.0	0.0	0.0	0.0	0.0	0.0	0.0	0.0	0.0	0.0
35.0	0.0	0.0	0.0	0.0	0.0	0.0	0.0	0.0	0.0	0.0	0.0	0.0	0.0	0.0	0.0	0.0	0.0	0.0	0.0	0.0
30.0	0.0	0.0	0.0	0.0	0.0	0.0	0.0	0.0	0.0	0.0	0.0	0.0	0.0	0.0	0.0	0.0	0.0	0.0	0.0	0.0
25.0	0.0	0.0	0.0	0.0	0.0	0.0	0.0	0.0	0.0	0.0	0.0	0.0	0.0	0.0	0.0	0.0	0.0	0.0	0.0	0.0
20.0	0.0	0.0	0.0	0.0	0.0	0.0	0.0	0.0	0.0	0.0	0.0	0.0	0.0	0.0	0.0	0.0	0.0	0.0	0.0	0.0
10.0	0.0	0.0	0.0	0.0	0.0	0.0	0.0	0.0	0.0	0.0	0.0	0.0	0.0	0.0	0.0	0.0	0.0	0.0	0.0	0.0

500 750 1000 1250 1500 2000 2500 3000 3500 4000 4500 5000 5500 6000 6500 7000 7500 8000 8500 9000

EngineSpeed [RPM]

Aside from these main fuel trims, there are a few other functions that can add fuel trims:

FuelTrim_N2O:

FuelTrim_N2O is the amount of fuel added when the nitrous function is enabled. See the [Nitrous N2O](#) section for more details.

FuelTrim_Decel:

FuelTrim_Decel is the amount of fuel added after the decel cut has turned off, to prevent the engine from running lean when the fuel turns back on. See the [Accel and Decel Fuel](#) section of the wizard for more details.

ChargeTempBlend

Units: Charge Temp Blend Multiplier vs RPM

Description: The table tells the Speed Density submodel whether to use Air Temp or Coolant Temp (or a blend of both) when calculating the density of the air entering the engine.

If set to a low number (0) the Air Temperature will be used when calculating the air density.

If set to a high number (1) the Coolant Temperature will be used when calculating the air density.

Typically, the table will have higher numbers at low RPM (assuming Coolant Temp has a greater influence on air density when velocity is low) and lower numbers at high RPM (assuming Air Temp has a greater influence on air density when velocity is high).

0.8	0.8	0.8	0.7	0.6	0.5	0.4	0.3	0.2	0.1	0.1	0.1	0.1	0.1	0.1	0.1
500.0	1000.0	1500.0	2000.0	2500.0	3000.0	3500.0	4000.0	4500.0	5000.0	5500.0	6000.0	6500.0	7000.0	7500.0	8000.0
EngineSpeed [RPM]															

InjXFuelTrimTable

Units: Injector1 Fuel % vs RPM

Description: This table allows for a cylinder trim of fuel injector 1. This can be used if there is a known flow discrepancy with an intake manifold runner or a mismatched fuel injector for instance. This table is a multiplier. A value of 1.00 represents no change. A value of 1.10 represents a 10% increase.

1.00	1.00	1.00	1.00	1.00	1.00	1.00	1.00	1.00	1.00	1.00
1000	2000	3000	4000	5000	6000	7000	8000	9000	10000	
EngineSpeed [RPM]										

Additional cylinder based fuel trims may be available depending on the hardware options.

Ignition Tuning

The ignition timing or spark timing value refers to the distance in crank degrees between the spark plug firing event (initiating combustion) and the uppermost point of the pistons stroke (top center TC, top dead center TDC, etc.).

If the start of the combustion process is progressively advanced before TDC, the compression stroke work transfer (which is from the piston to the cylinder gases) increases. If the end of the combustion process is progressively delayed by retarding the spark timing, the peak cylinder pressure occurs later in the expansion stroke and is

reduced in magnitude. These changes reduce the expansion stroke work transfer from the cylinder gases to the piston. The optimum timing which gives the maximum brake torque called maximum brake torque (or MBT timing) occurs when the magnitudes of these two opposing trends just offset each other. Timing which is advanced or retarded from this optimum gives lower torque. MBT timing defines the optimum point (maximum brake torque) for peak cylinder pressure relative to crank angle.

Certain operating conditions, combustion chamber designs, fuel types, etc. will prohibit an engine from reaching MBT timing before detonation occurs. Detonation, or spark knock, is caused by the gases spontaneously combusting at the outer edges of the piston before the normal combustion flame front reaches those areas. This causes pressure spikes that can damage the engine over time.

Every engine will have different spark timing requirements. Unlike fuel tuning where you can take advantage of inexpensive, commonly available wideband oxygen sensor kits, spark tuning requires expensive laboratory equipment for complete optimization. Spark tuning is best accomplished on an engine dyno. If that is not practical, a chassis dyno is the next best thing. But even with the use of a dyno, spark tuning requires experience to know where to start and what kind of changes to make. Ignition timing values can range from 50+ degrees BTDC to 15+ degrees after top dead center for certain extreme conditions on race vehicles.

Ignition Synchronization

The ignition timing measured with a timing light must be synchronized with the displayed value in Infinity Tuner. This is one of the most important steps in the setup process. Without it, the commanded ignition timing may not be accurate.

It's a good idea to disable the fuel injectors and/or fuel pump during this step as well. Until the timing is sync'd, it doesn't make any sense to inject fuel just to fire it at the wrong time. The ignition coil(s) must be connected and in working order.

See [Ignition Sync](#)¹⁰⁹ for more detail.

BaseIgnMap

Units: MAP vs RPM vs Ignition Timing BTDC

Description: This is the core ignition map that all trims are based from. The higher the value, the more advanced the timing will be. The lower the value, the more retarded the timing is. Negative values are further retarding the ignition timing, but is actually firing the spark plugs after top dead center (ATDC).

BaseIgnMap [degBTDC]

320.0	2.0	2.0	2.0	2.0	2.0	2.0	2.0	2.0	2.0	2.0	2.0	2.0	2.0	1.0	1.0	1.0	1.0	1.0	1.0	1.0	1.0
300.0	2.0	2.0	2.0	2.0	2.0	2.0	2.0	2.0	3.0	3.2	3.3	2.5	2.7	2.7	2.7	2.7	2.7	2.7	2.7	2.7	2.7
280.0	2.0	2.0	2.0	2.0	2.0	2.0	2.0	2.0	2.0	4.3	4.7	4.0	4.3	4.3	4.3	4.3	4.3	4.3	4.3	4.3	4.3
260.0	4.0	4.0	4.0	4.0	4.0	4.0	4.0	4.0	5.0	5.5	6.0	5.5	6.0	6.0	6.0	6.0	6.0	6.0	6.0	6.0	6.0
240.0	4.0	4.0	4.0	4.0	4.0	4.0	4.0	5.0	6.0	6.7	7.3	7.0	7.7	7.7	7.7	7.7	7.7	7.7	7.7	7.7	7.7
220.0	4.0	4.0	4.0	4.0	4.0	4.0	4.0	5.0	7.0	7.8	8.7	8.5	9.3	9.3	9.3	9.3	9.3	9.3	9.3	9.3	9.3
200.0	8.0	8.0	8.0	8.0	8.0	8.0	8.2	8.4	8.6	8.8	9.0	9.2	9.5	9.8	10.0	10.0	10.0	10.0	10.0	10.0	10.0
180.0	8.0	8.0	8.0	8.0	8.0	8.0	9.6	12.2	12.0	12.0	12.0	12.0	12.0	12.0	12.0	12.0	12.0	12.0	12.0	12.0	12.0
160.0	9.0	9.0	9.0	9.0	9.0	10.5	12.0	13.5	15.0	15.0	15.0	15.0	15.0	15.0	15.0	15.0	15.0	15.0	15.0	15.0	15.0
140.0	9.0	9.0	9.0	9.0	11.0	12.7	15.5	17.2	18.7	19.0	19.1	19.2	19.3	19.3	19.4	19.5	19.5	19.5	19.5	19.5	19.3
120.0	10.0	10.0	10.0	10.0	13.0	14.8	18.9	20.9	22.4	23.0	23.2	23.5	23.6	23.7	23.8	24.0	24.1	24.1	24.1	24.1	23.7
100.0	15.0	15.0	15.0	15.0	15.0	17.0	22.4	24.5	26.1	26.9	27.2	27.7	27.9	28.0	28.2	28.5	28.6	28.6	28.6	28.0	28.0
80.0	16.0	16.0	16.0	16.3	16.6	18.4	25.9	28.2	29.8	30.9	31.3	32.0	32.2	32.4	32.6	33.0	33.1	33.2	33.2	33.2	33.2
60.0	16.8	16.8	16.9	17.6	21.4	26.6	31.6	34.0	35.2	35.9	35.3	35.6	36.1	36.7	37.2	37.8	38.2	38.3	38.3	38.3	38.3
40.0	17.0	17.0	17.1	18.3	23.0	28.6	33.5	35.6	36.7	37.2	36.4	36.6	37.2	37.9	38.5	39.1	39.7	39.8	39.8	39.8	39.8
35.0	17.0	17.0	17.2	18.4	23.1	28.9	33.8	35.8	36.9	37.3	36.6	36.7	37.3	38.0	38.7	39.3	39.8	40.0	40.0	40.0	40.0
30.0	17.0	17.0	17.2	18.5	23.2	28.9	33.8	35.9	36.9	37.3	36.6	36.7	37.3	38.0	38.7	39.3	39.8	40.0	40.0	40.0	40.0
25.0	17.0	17.0	17.2	18.5	23.2	28.9	33.8	35.9	36.9	37.3	36.6	36.7	37.3	38.0	38.7	39.3	39.8	40.0	40.0	40.0	40.0
20.0	17.0	17.0	17.2	18.5	23.2	28.9	33.8	35.9	36.9	37.3	36.6	36.7	37.3	38.0	38.7	39.3	39.8	40.0	40.0	40.0	40.0
10.0	17.0	17.0	17.2	18.5	23.2	28.9	33.8	35.9	36.9	37.3	36.6	36.7	37.3	38.0	38.7	39.3	39.8	40.0	40.0	40.0	40.0
	500	750	1000	1250	1500	2000	2500	3000	3500	4000	4500	5000	5500	6000	6500	7000	7500	8000	8500	9000	

MAP [kPa]

EngineSpeed [RPM]

Ignition Trims

IgnTrimAirTempMap

Units: MAP vs AirTemp vs Ignition Timing

Description: This table allows for an ignition timing compensation based on engine load and intake air temperature.

IgnTrimAirTempMap [degBTDC]

300.0	0.0	0.0	0.0	0.0	0.0	0.0	-2.0	-2.0	-2.0	-2.0
200.0	0.0	0.0	0.0	0.0	0.0	0.0	-2.0	-2.0	-2.0	-2.0
100.0	0.0	0.0	0.0	0.0	0.0	0.0	0.0	0.0	0.0	0.0
50.0	0.0	0.0	0.0	0.0	0.0	0.0	0.0	0.0	0.0	0.0
	0.0	10.0	20.0	30.0	40.0	50.0	60.0	70.0	80.0	100.0

MAP [kPa]

AirTemp [C]

IgnTrimCoolantTempMap

Units: MAP vs CoolantTemp vs Ignition Timing

Description: This table allows for an ignition timing compensation based on engine load and coolant temperature. On a catalyst vehicle, retarding the ignition timing can be used to light a cool catalytic converter off sooner for improved emissions.

IgnTrim_2 [%]

Units: EngineSpeed vs MAP vs Ign Trim

Description: This table is a generic 2-axis ign trim.

The screenshot shows a window titled 'IgnTrim_2' containing a 2D table. The vertical axis is labeled 'MAP [kPa]' and ranges from 10 to 320 in increments of 20. The horizontal axis is labeled 'EngineSpeed [RPM]' and ranges from 500 to 9000 in increments of 250. Every cell in the table contains the value '0.0'. The cell at the intersection of 10 kPa MAP and 500 RPM is highlighted in purple.

CoilXTrimTable

Units: Coil 1 Ignition Timing vs RPM

Description: This table allows for a cylinder ignition trim of coil 1. This can be used if there is a known exhaust gas temperature discrepancy with a runner for instance.

The screenshot shows a window titled 'Coil1TrimTable [deg]'. It displays a single row of ten '0' values. Below the row is a horizontal axis labeled 'EngineSpeed [RPM]' with tick marks at 1000, 2000, 3000, 4000, 5000, 6000, 7000, 8000, 9000, and 10000. The first '0' value is highlighted in purple.

The number of cylinder based coil trims depends on the hardware features.

DBW Idle Air Control

Tuning idle with a DBW-equipped vehicle will feel very similar to tuning idle with traditional idle airflow valves; the standard tables like **IdleTargetTable [RPM]**, **IdleBasePosition**, and **Idle_Decel** should be used as usual.

The drive-by-wire system uses the throttle to manage airflow, including idle airflow, to the engine. For managing idle airflow control, the ECU rescales the 0-100% **Idle Position** value calculated by the ECU's idle functions into a smaller value 'DBW_IdleTrim [%]', which is one of the factors involved in the **DBW_Target [%]** calculation.

The value for **DBW Idle Control Range** sets the maximum allowed throttle to be used for idle airflow adjustment,

when the calculated value for **Idle Position** is 100%. If the DBW throttle body is relatively large compared to the engine's airflow requirements, it may be helpful to decrease DBW Idle Control Range to smaller values such as 5% so the idle function and idle feedback values have less of an effect on engine airflow.

Advanced Tuning

Wizard Advanced Setup

Accel and Decel Fuel

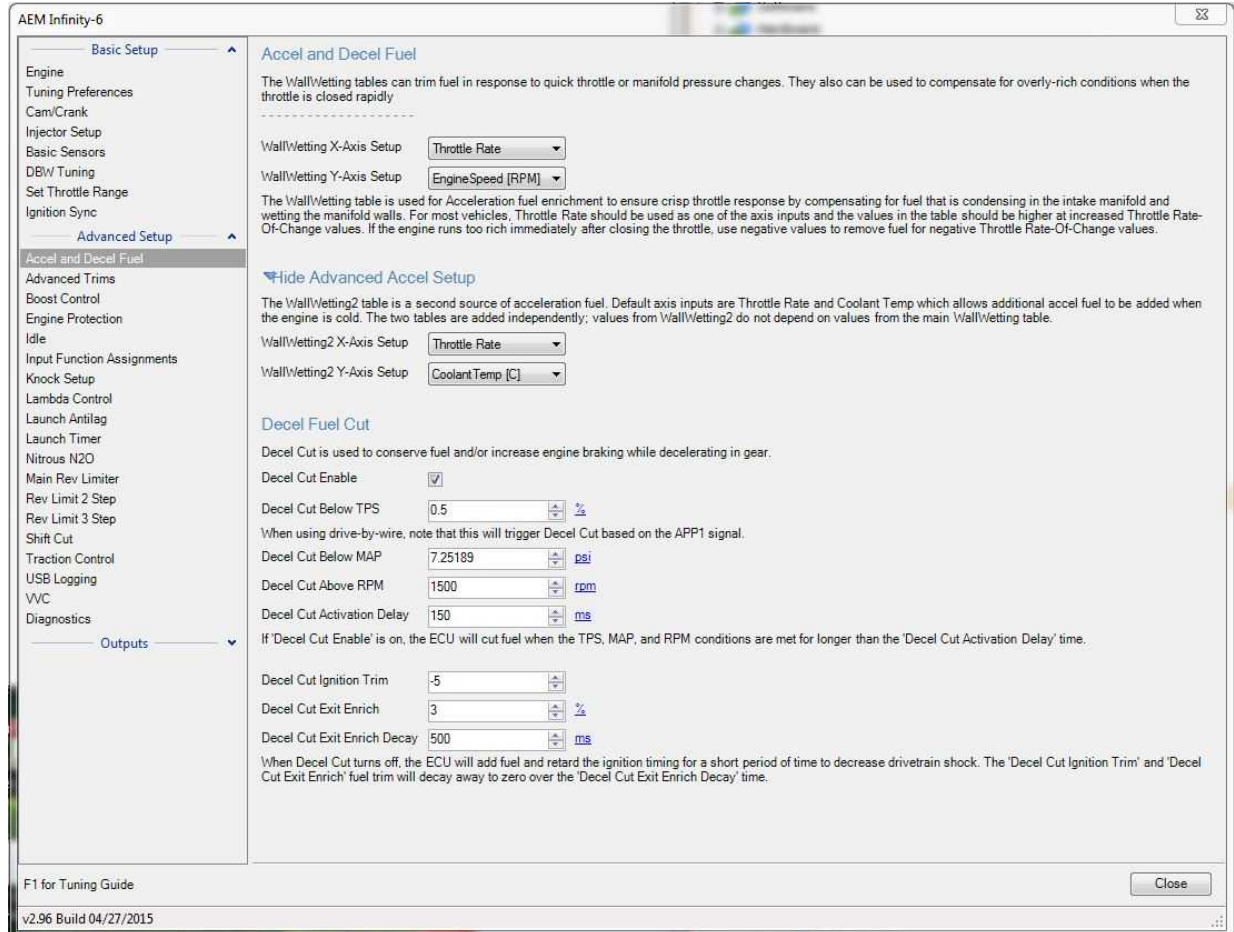

WallWetting X-Axis Setup:

This allows the x-axis of the WallWetting table to be reassigned from the default setting of Throttle Rate to other inputs such as MAP, MAP Rate, Coolant Temp, or Engine Speed.

WallWetting2 Y-Axis Setup:

This allows the y-axis of the WallWetting2 table to be reassigned from the default setting of Engine Speed to other inputs such as MAP, MAP Rate, Coolant Temp, or Throttle Rate.

WallWetting2 X-Axis Setup:

This allows the x-axis of the WallWetting2 table to be reassigned from the default setting of Throttle Rate to other inputs such as MAP, MAP Rate, Coolant Temp, or Engine Speed.

WallWetting Y-Axis Setup:

This allows the y-axis of the WallWetting table to be reassigned from the default setting of Engine Speed to other inputs such as MAP, MAP Rate, Coolant Temp, or Throttle Rate.

Decel Cut Enable:

Enable/disables the deceleration fuel cut feature.

Decel Cut Below TPS:

Fuel will be cut if the throttle is below this value, and all other conditions or met. Set this as low as possible, if this value is too high the engine will 'hesitate' due to Decel cut remaining active when the driver wants to accelerate.

Min value = 0%, Max value = 100%

Note when using drive-by-wire, this will trigger Decel Cut based on the APP1 signal.

Decel Cut Below MAP:

Fuel will be cut if the MAP signal is below this value, and all other conditions or met. This should be set to at least 2-3 kPa lower than the MAP value at idle .

Min value = 0 kPa, Max value = 110 kPa

Decel Cut Above RPM:

Fuel will be cut if the Engine Speed is above this value, and all other conditions or met. This should be set to at least 100–200 RPM higher the target idle RPM.

Min value = 1000 RPM, Max value = 15000 RPM

Decel Cut Activation Delay:

Fuel will be cut if all the conditions above are met for this amount of time. This should be set high enough to avoid triggering decel fuel cut when shifting gears quickly.

Min value = 0 ms, Max value = 2000 ms

Decel Cut Ignition Trim:

After decel cut turns off, the ECU will retard ignition timing by this amount to decrease drivetrain shock.

Min value = 0 ms, Max value = 2000 ms

Decel Cut Exit Enrich:

After decel cut turns off, the ECU will increase fuel by this amount to avoid hesitation by replacing the fuel that was removed from intake runner surfaces while the fuel cut was active.

Min value = 0%, Max value = 40%

Decel Cut Exit Enrich Delay:

After decel cut turns off, the 'Decel Cut Ignition Trim' and 'Decel Cut Exit Enrich' trims will decay away over this amount of time.

Min value = 0 ms, Max value = 2000 ms

Advanced Trims

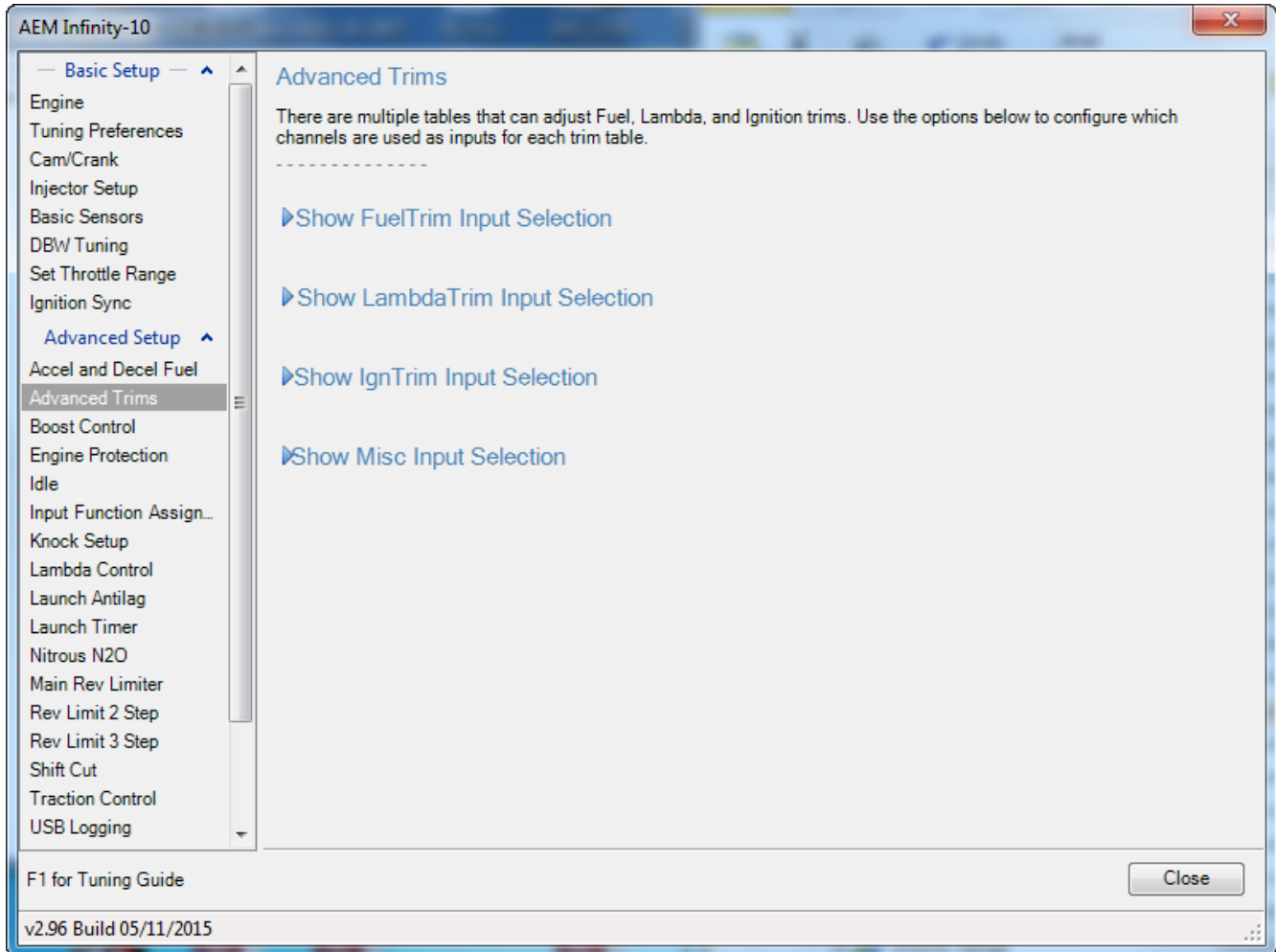

The categories can be expanded or collapsed.

▼Hide FuelTrim Input Selection

FuelTrim_1 and FuelTrim_2 are percentage modifier tables for adjusting delivered fuel depending on MAP, Throttle, Gear, or other available input channels. They can be used as additional 'dimensions' of fuel control; for instance using Throttle for the VETable input and MAP for the FuelTrim_1 input may help the ECU reach the desired LambdaTarget with better accuracy than using MAP or Throttle alone.

FuelTrim_1 Table x-axis

FuelTrim_1 Table y-axis

FuelTrim_2 Table x-axis

FuelTrim_2 Table y-axis

FuelTrim_1 Table x-axis:

This allows the x-axis of the FuelTrim_1 table to be reassigned from the default setting. Many input options are

possible. Once the axis selections are made, add the table to your Infinity Tuner layout for tuning.

FuelTrim_1 Table y-axis:

This allows the y-axis of the FuelTrim_1 table to be reassigned from the default setting. Many input options are possible. Once the axis selections are made, add the table to your Infinity Tuner layout for tuning.

FuelTrim_2 Table x-axis:

This allows the x-axis of the FuelTrim_2 table to be reassigned from the default setting. Many input options are possible. Once the axis selections are made, add the table to your Infinity Tuner layout for tuning.

FuelTrim_2 Table y-axis:

This allows the y-axis of the FuelTrim_2 table to be reassigned from the default setting. Many input options are possible. Once the axis selections are made, add the table to your Infinity Tuner layout for tuning.

▼Hide LambdaTrim Input Selection

LambdaTrim_1 is a table for modifying the ECU's LambdaTarget. Note that LambdaTarget is used for both open-loop and closed-loop fueling calculations, so this table should be used to define when the engine should run an extra rich or lean AFR depending on Throttle, Gear, or other available input channels.

LambdaTrim_1 Table x-axis EngineSpeed [RPM] ▼

LambdaTrim_1 Table y-axis MAP [kPa] ▼

LambdaTrim_1 Table x-axis:

This allows the x-axis of the LambdaTrim_1 table to be reassigned from the default setting. Many input options are possible. Once the axis selections are made, add the table to your Infinity Tuner layout for tuning.

LambdaTrim_1 Table y-axis:

This allows the y-axis of the LambdaTrim_1 table to be reassigned from the default setting. Many input options are possible. Once the axis selections are made, add the table to your Infinity Tuner layout for tuning.

▼Hide IgnTrim Input Selection

IgnTrim_1 and IgnTrim_2 are tables for modifying the ECU's SpkTiming value. These tables can be used to add or remove timing depending on Throttle, Gear, spare Analog inputs, or other available input channels.

IgnTrim_1 Table x-axis EngineSpeed [RPM] ▼

IgnTrim_1 Table y-axis MAP [kPa] ▼

IgnTrim_2 Table x-axis EngineSpeed [RPM] ▼

IgnTrim_2 Table y-axis MAP [kPa] ▼

IgnTrim_1 Table x-axis:

This allows the x-axis of the IgnTrim_1 table to be reassigned from the default setting. Many input options are possible. Once the axis selections are made, add the table to your Infinity Tuner layout for tuning.

IgnTrim_1 Table y-axis:

This allows the y-axis of the IgnTrim_1 table to be reassigned from the default setting. Many input options are possible. Once the axis selections are made, add the table to your Infinity Tuner layout for tuning.

IgnTrim_2 Table x-axis:

This allows the x-axis of the IgnTrim_2 table to be reassigned from the default setting. Many input options are possible. Once the axis selections are made, add the table to your Infinity Tuner layout for tuning.

IgnTrim_2 Table y-axis:

This allows the y-axis of the IgnTrim_2 table to be reassigned from the default setting. Many input options are possible. Once the axis selections are made, add the table to your Infinity Tuner layout for tuning.

Hide Misc Input Selection

The FlexCrankingAdder Table can be used to add injector pulse width during cranking based on flex content.

Flex Cranking Adder Table y-axis

The table StagedSplit can be used to manually control the percentage of total fuel volume to be delivered via the primary injectors on staged injection setups.

StagedSplit Load Axis selection

The tables 'Inj1Trim - Inj8Trim' are percentage modifier tables for adjusting fuel delivered to specific injector outputs.

'Inj1Trim - Inj8Trim' y-axis

Flex Cranking Adder Table y-axis:

This allows the y-axis of the FlexCrankingAdder table to be reassigned from the default setting. Input options depend on the particular hardware platform. Once the axis selections are made, add the table to your Infinity Tuner layout for tuning.

StagedSplit Load Axis selection:

This allows the y-axis of the StagedSplit [%] table to be reassigned from the default setting. Once the axis selections are made, add the table to your Infinity Tuner layout for tuning.

Inj1Trim - Inj8Trim y-axis:

This allows y-axis selection for the 8 high resolution individual cylinder injector trim tables.

Boost Control

The Infinity has a very comprehensive and flexible boost control strategy. Using a pulse width modulated (PWM) solenoid, boost can be controlled by vehicle speed, throttle position, rpm, switch input, etc. AEM recommends using the AEM Boost Solenoid Kit (AEM P/N: 30-2400) for boost control which is good for 120psi. Another solenoid that is commonly used is the GM PWM Boost Solenoid (GM P/N: 1997152).

The AEM and GM solenoids, listed above, are both 3-way valves which can be either normally closed (N.C.) or normally open (N.O.) valves depending on which port the filter (muffler) is attached. 2-way boost solenoids are also found in factory turbocharged vehicles. Depending on the manufacturer, these can be normally closed (N.C.) or normally open (N.O.) valves. In other words, if they were unplugged, the some would block flow and some would allow flow to pass through as if it were not installed. On the other hand, if a constant 12V and ground were applied to solenoid, the exact opposite would happen. If an unknown solenoid is being used, this can be easily tested by blowing through the solenoid while disconnected.

Because of the discrepancies between solenoids and wastegate types, there should be some thought put into plumbing and how the Infinity Tuner software will control them. Below are a few different examples, however, there are many other wastegate styles and turbocharger setups that are not listed.

When using the AEM 30-2400 with an internal wastegate, AEM recommends plumbing the vacuum (boost) lines like the following:



When using the AEM 30-2400 solenoid with an external wastegate, AEM recommends plumbing the vacuum (boost) lines like the following:

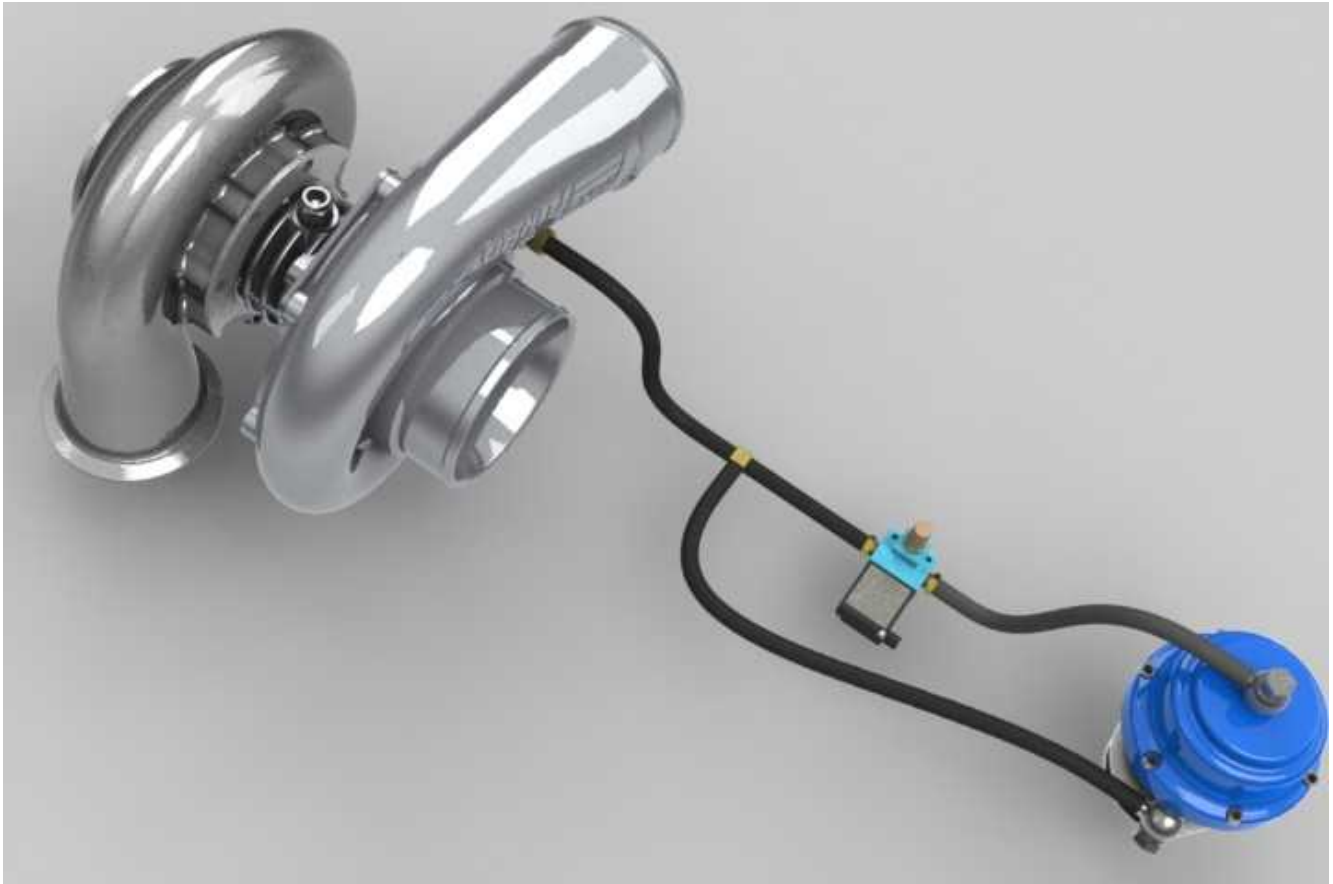

When using the GM 1997152 solenoid with an internal wastegate, AEM recommends plumbing the vacuum (boost) lines like the following:



When using the GM 1997152 solenoid with an external wastegate, AEM recommends plumbing the vacuum (boost) lines like the following:



The next step in creating a new setup is determining what frequency the solenoid needs to be operated. This information is typically provided by the manufacturer of the part. Both AEM and GM solenoids are optimal at 31Hz. If using a plug n' play Infinity ECU with a factory boost control solenoid, this comes pre configured by AEM.

The default Infinity PWM output for boost control is LowsideSwitch_2 (Pin C1-17). There are two wire connections for a boost solenoid and there is no polarity. One wire connects to 12 volt switched power and the other will connect to Infinity Pin C1-17.

To understand how the solenoid becomes a variable air flow restricting valve to meet a specific wastegate position, note the following duty cycle signal examples. The oscilloscope trace below shows a 30Hz, 50% duty cycle signal coming from the Infinity ECU. The solenoid will be ON when the signal is low and OFF when the signal is high.

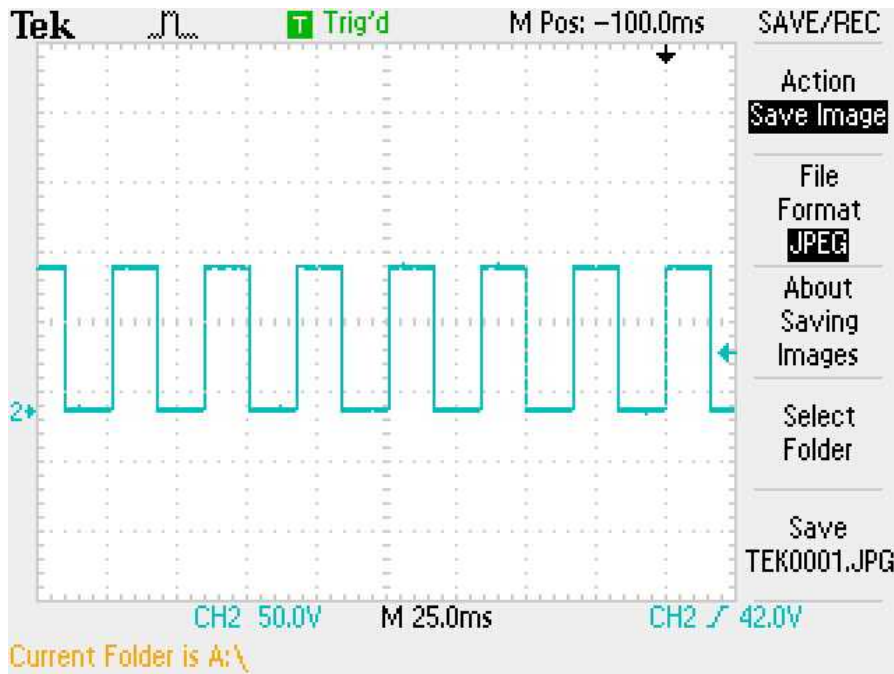

The oscilloscope trace below shows a 30Hz, 20% duty cycle signal. The solenoid will be ON when the signal is low (20% of the time) and OFF when the signal is high (80% of the time).

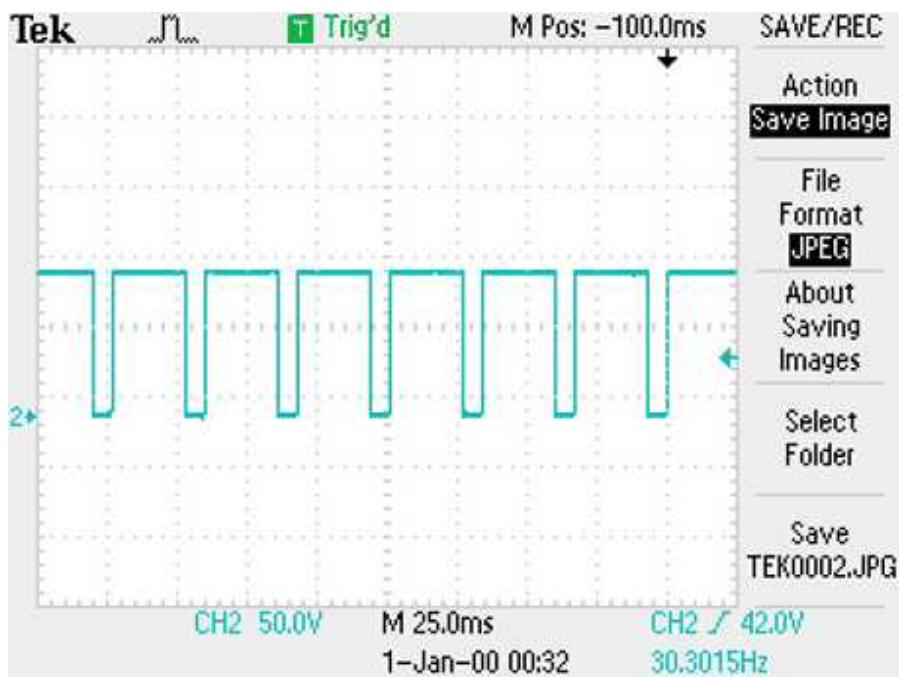

Boost Control Related Functions

The following settings are available in the Boost Control Setup Wizard page.

Boost Output Enable

Units: On/Off

Description: This enables the boost control feature.



Boost Output Enable

Boost Feedback Enable

Boost Feedback Enable

Units: On/Off

Description: This enables the closed loop boost control feedback PID strategy. When performing the preliminary boost tuning, it is advisable to turn this OFF. Once the open loop duty cycle output from the various lookup tables is complete and the boost pressure is close to the desired target, this can be activated. PID (proportional, integral, derivative) control will always work better when it does not need to make large corrections.

Base Duty Tables Axis Setup

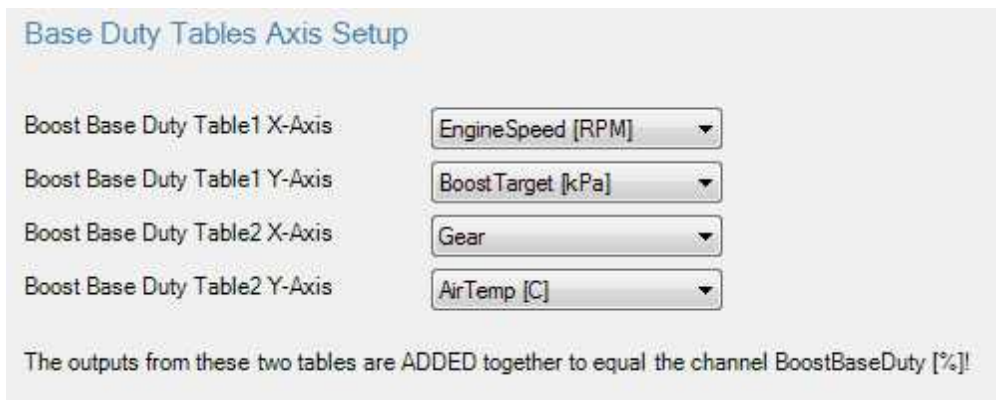

Base Duty Tables Axis Setup

Boost Base Duty Table1 X-Axis: EngineSpeed [RPM]

Boost Base Duty Table1 Y-Axis: BoostTarget [kPa]

Boost Base Duty Table2 X-Axis: Gear

Boost Base Duty Table2 Y-Axis: AirTemp [C]

The outputs from these two tables are ADDED together to equal the channel BoostBaseDuty [%]!

There are two 2D base duty tables in the calibration. They are named:

- BoostBaseDuty1 [%]
- BoostBaseDuty2 [%]

These two tables add together so the user can use one table as primary and the second as a trim if desired. Both axis inputs are selectable from the drop down lists shown above.

Boost Target Tables Axis Setup

Boost Target Tables Axis Setup

Boost Target Table1 X-Axis	<input type="text" value="Gear"/>
Boost Target Table1 Y-Axis	<input type="text" value="Throttle [%]"/>
Boost Target Table2 X-Axis	<input type="text" value="FlexContent [%]"/>
Boost Target Table2 Y-Axis	<input type="text" value="InjPressure [psig]"/>

The outputs from these two tables are ADDED together to equal the channel BoostTarget [kPa]!

There are two 2D boost target tables in the calibration. They are named:

- BoostTargetTable1 [kPa]
- BoostTargetTable2 [kPa]

These two tables add together so the user can use one table as a primary and the second as a trim if desired. Both axis inputs are selectable from the drop down lists shown above.

Boost Control Gain Table setup

Use the following tables to configure your boost control PID gains vs engine speed.

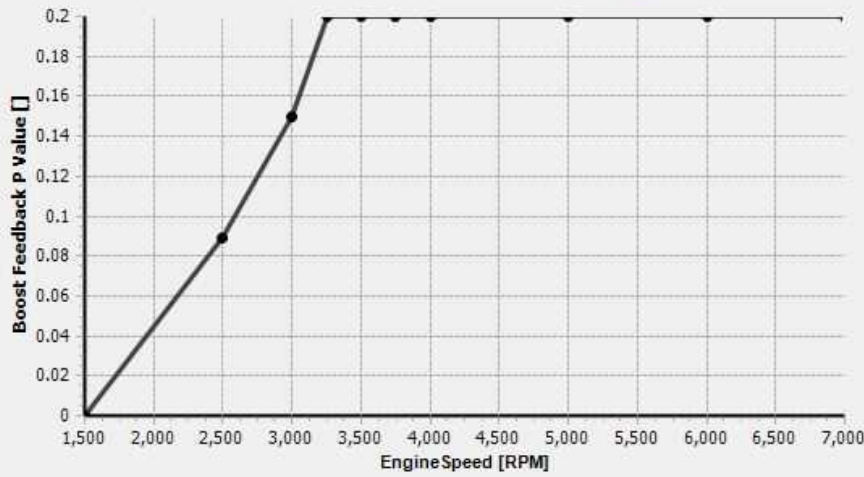

EngineSpeed [RPM]	Boost Feedback P Value []
1500	0.000
2500	0.089
3000	0.150
3250	0.200
3500	0.200
3750	0.200
4000	0.200
5000	0.200
6000	0.200
7000	0.200

▼Hide BoostGain_Ki Table Setup

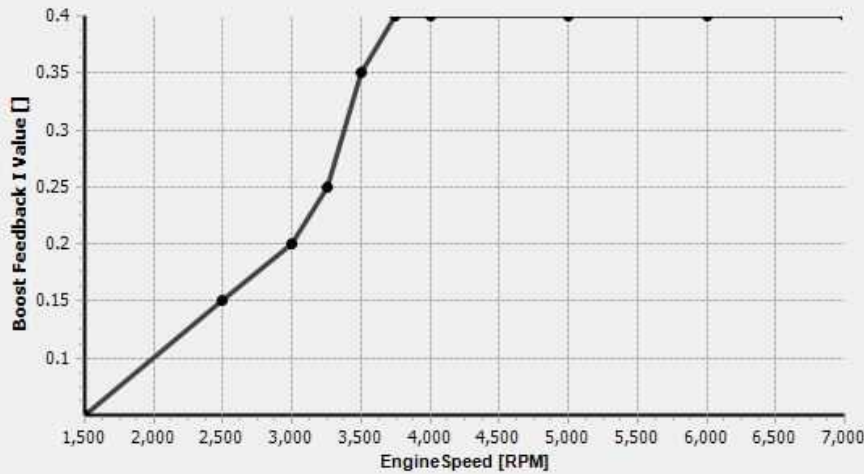

EngineSpeed [RPM]	Boost Feedback I Value []
1500	0.050
2500	0.150
3000	0.200
3250	0.250
3500	0.350
3750	0.400
4000	0.400
5000	0.400
6000	0.400
7000	0.400

▼Hide BoostGain_Kd Table Setup

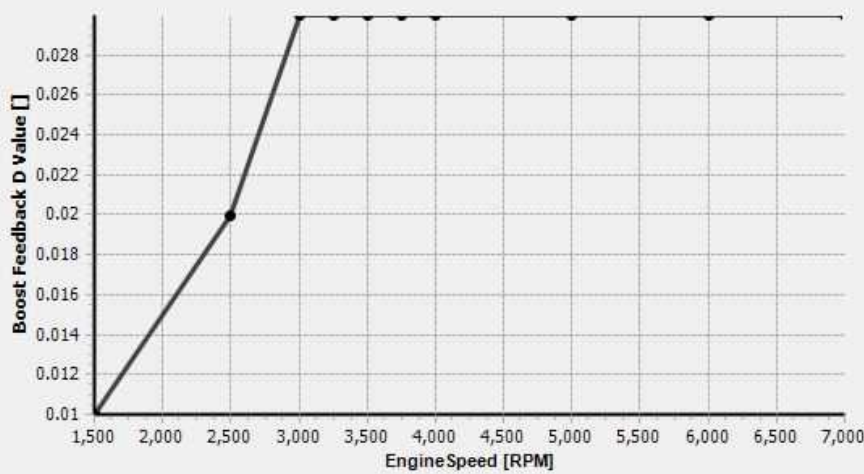

EngineSpeed [RPM]	Boost Feedback D Value []
1500	0.010
2500	0.020
3000	0.030
3250	0.030
3500	0.030
3750	0.030
4000	0.030
5000	0.030
6000	0.030
7000	0.030

Boost Solenoid Control Frequency [Hz]**Units:** Hz**Description:** This should be set to the manufacturer specifications. This sets the frequency to operate the pulse width modulated boost solenoid. If the boost solenoid is excessively noisy and/or slow to respond, the frequency should be changed. Note: Most boost solenoids make some noise.

Min value = 0, Max value = 1000

Boost Solenoid Max Duty Cycle [%]**Units:** %**Description:** This should be set to the manufacturer specifications. This sets the maximum duty cycle allowed.

Min value = 0, Max value = 100

Boost Duty Cycle Invert**Units:** On/Off**Description:** This setting inverts the PID feedback logic.**Boost Use ChargeOutPress****Units:** On/Off**Description:** Optional setting to use ChargeOutPressure channel as the boost control feedback value instead of manifold pressure.**Boost Integral Gain Low Clamp****Units:** Clamp**Description:** This keeps the integral gain from winding down and limits its contribution.

Min value = -10, Max value = 10. Note: BoostControlIntClampH must be greater than BoostControlIntClampL.

Boost Integral Gain High Clamp**Units:** Clamp**Description:** This keeps the integral gain from winding up and limits its contribution.

Min value = -10, Max value = 10. Note: BoostControlIntClampH must be greater than BoostControlIntClampL.

Boost Integral Gain High Clamp**Units:** Clamp**Description:** This keeps the integral gain from winding up and limits its contribution.

Min value = -10, Max value = 10. Note: BoostControlIntClampH must be greater than BoostControlIntClampL.

Boost Solenoid Min Throttle**Units:** %**Description:** Below this TPS value, the boost duty output is disabled.

Min value = 0, Max value = 100.

BoostBaseDuty1 [%]

Units: Selectable via setup wizard

Description: Base wastegate duty cycle as a function of selectable axis inputs. This table is used to set the base duty cycle to the boost control solenoid. Set this by disabling the feedback controls first. This is done by setting the **BoostControl_Kp**, **BoostControl_Ki**, and **BoostControl_Kd** all to zero. Adjust this table until the desired boost is as closely achieved as possible. The closer this table gets to the targeted boost pressure, the better the closed loop boost control feedback will work. This table determines the base duty cycle percentage used if or if not using closed loop boost control feedback. This is the first feature to tune when using boost control.

BoostTarget [kPa]	3500	4000	4500	5000	5500	6000	6500	7000	7500	8000
350	100	100	100	100	100	100	100	100	100	100
325	100	85	85	85	86	86	86	87	87	88
300	100	70	70	70	72	72	72	74	74	75
275	100	54	54	55	57	57	55	55	54	57
250	100	40	40	41	43	43	43	47	47	50
225	100	36	36	36	36	37	37	39	39	45
200	100	34	34	34	34	34	34	37	37	40
175	100	0	0	0	0	0	0	0	0	0
150	100	0	0	0	0	0	0	0	0	0

BoostBaseDuty2 [%]

Units: Selectable via setup wizard

Description: Base wastegate duty cycle adder as a function of selectable axis inputs. The values in this table ADD TO the values in the BoostBaseDuty1 [%] table.

AirTemp [C]	0	1	2	3	4	5	6	7	8	9
80	0	0	0	0	0	0	0	0	0	0
60	0	0	0	0	0	0	0	0	0	0
50	0	0	0	0	0	0	0	0	0	0
40	0	0	0	0	0	0	0	0	0	0
30	0	0	0	0	0	0	0	0	0	0
20	0	0	0	0	0	0	0	0	0	0
15	0	0	0	0	0	0	0	0	0	0
10	0	0	0	0	0	0	0	0	0	0
5	0	0	0	0	0	0	0	0	0	0

BoostTargetTable1 [kPa]

Units: Selectable via setup wizard

Description: Base boost target values as a function of selectable axis inputs.

BoostTargetTable1 [kPa]

100	200	200	200	200	200	200	200	200	200	200
90	200	200	200	200	200	200	200	200	200	200
80	200	200	200	200	200	200	200	200	200	200
70	200	200	200	200	200	200	200	200	200	200
60	200	200	200	200	200	200	200	200	200	200
50	200	200	200	200	200	200	200	200	200	200
40	200	200	200	200	200	200	200	200	200	200
30	200	200	200	200	200	200	200	200	200	200
20	200	200	200	200	200	200	200	200	200	200
10	200	200	200	200	200	200	200	200	200	200

FlexContent [%]

BoostTargetTable2 [kPa]

Units: Selectable via setup wizard

Description: Base boost target adder values as a function of selectable axis inputs. The values in this table ADD TO the values in the BoostTargetTable1 [kPa] table.

BoostTargetTable2 [kPa]

1.0	0	25	50	75	75	75	75	75	75	75
0.9	0	25	50	75	75	75	75	75	75	75
0.8	0	25	50	75	75	75	75	75	75	75
0.7	0	25	50	75	75	75	75	75	75	75
0.6	0	25	50	75	75	75	75	75	75	75
0.4	0	25	50	75	75	75	75	75	75	75
0.3	0	25	50	75	75	75	75	75	75	75
0.2	0	25	50	75	75	75	75	75	75	75
0.1	0	25	50	75	75	75	75	75	75	75
0.0	0	25	50	75	75	75	75	75	75	75

ModeSwitch

Tuning Tips for Boost Control

Tuning Boost Control can be the most time consuming of all the variables of tuning. After the following testing procedure commences on the dynamometer, note that the race track can create new "real-world" vehicle loads on the engine so boost control should always be reconfirmed.

- Open Infinity Tuner software and connect to the Infinity.
- Confirm that the throttle position is set properly (closed < 5%, WOT > 95%) .

- Confirm the AFR so that the vehicle has sufficient fuel for boosting.
- Open the **Boost Control Wizard** and click the **Boost Output Enable** option ON.
- Uncheck **Boost Feedback Enable** to temporarily turn OFF closed loop boost control.

Next, determine if an increase in duty to the wastegate solenoid takes away boost pressure or makes boost pressure. To determine this, find the particular wastegate setup being used from the diagrams above. The language of the boost solenoid is in percent duty cycle. This is not percent open or percent of airflow, it is rather the full-scale percentage of the solenoid where 100% is fully closed or fully open depending on the solenoid used and how it is plumbed.

- If more duty decreases boost pressure, check **Boost Feedback Invert**.
- Set the **Boost Solenoid Control Frequency** channel according to the manufacturer specifications.
Typical 30Hz

The next step before tuning boost is to set the max and overboost cut to eliminate any overshooting errors which can lead to catastrophic engine problems.

- In the **Wizard**, go to **Engine Protection** under **Setup**.
- In the Boost Protection section, set the **Max Boost Limit** and **Overboost Allowed** option to safe values.

Overboost Protection

Max Boost Limit kPa(abs)
ECU will cut fuel and spark if boost ever exceeds this value.

OverBoost Allowed kPa(abs)
ECU will cut fuel and spark if boost exceeds the Boost Target by this much.

- Open the **BoostTab** and set the entire **BoostBaseDuty1 [%] Table** to 0%.
- Start the engine
- Go to **Log | Start Recording**
- Using an dynamometer, cautiously go to full throttle but keep an eye on the viewable **MAP** channel.
- Go to **Log | Stop Recording**

From observing the log, the maximum boost pressure should be the same as the wastegate spring pressure. Keep in mind that there are other mechanical situations which can change the outcome. For instance, an improper exhaust manifold (or turbo) wastegate port can create "boost creep".

From the log, the proper open loop boost control duty cycle% can now be determined by viewing the **MAP** and **BoostControl** channels. It is a good idea to make a boost log sheet. This will speed up boost control tuning when feedback is used by giving you an idea of the duty cycle that will achieve each boost level. The chart will be dependent on the mechanics of the turbo system, including: wastegate spring, turbocharger, exhaust back pressure, etc. See the example below:

Boost WG Out	Engine Load
0%	7psi
10%	9psi
20%	11psi
30%	13psi
40%	15psi
50%	17psi
60%	19psi
70%	21psi
80%	23psi
90%	25psi
100%	27psi

After the appropriate duty cycle is found that is necessary to reach the desired boost target, the boost control feedback can be enabled. To do this, check the **Boost Feedback Enable** box in the **Boost Wizard**. Now enter the boost target in the **BoostTarget1 [%] Table**.

Below is an example of boost control on an AWD time attack vehicle (not traction limited) that doesn't need boost-by-gear (or speed). However, there is an AEM 12-position switch (p/n 30-2056) installed so the boost can be adjusted on the fly.

Notice that there are also several failsafe strategies that will limit boost if the charge air temperature is too high (heatsoak) or if the coolant temp is out of range (engine too cold or overheating). In addition, the boost target mapping for the 12-position switch only allows certain (higher) boost levels if the Ethanol content is high enough to support the boost. The boost target is also varied based on throttle position, to allow the driver to use the throttle for linear power delivery, which makes the car much easier to drive on a road course where part-throttle is common. To aid in spool, the duty-cycle is increased at lower RPM where the engine cannot attain full boost, and at lower boost pressures, again to keep the wastegate closed as long as possible to improve response.

The PID system on the Infinity is extremely fast and you'll notice no Derivative Gain (BoostGain_Kd) was needed.

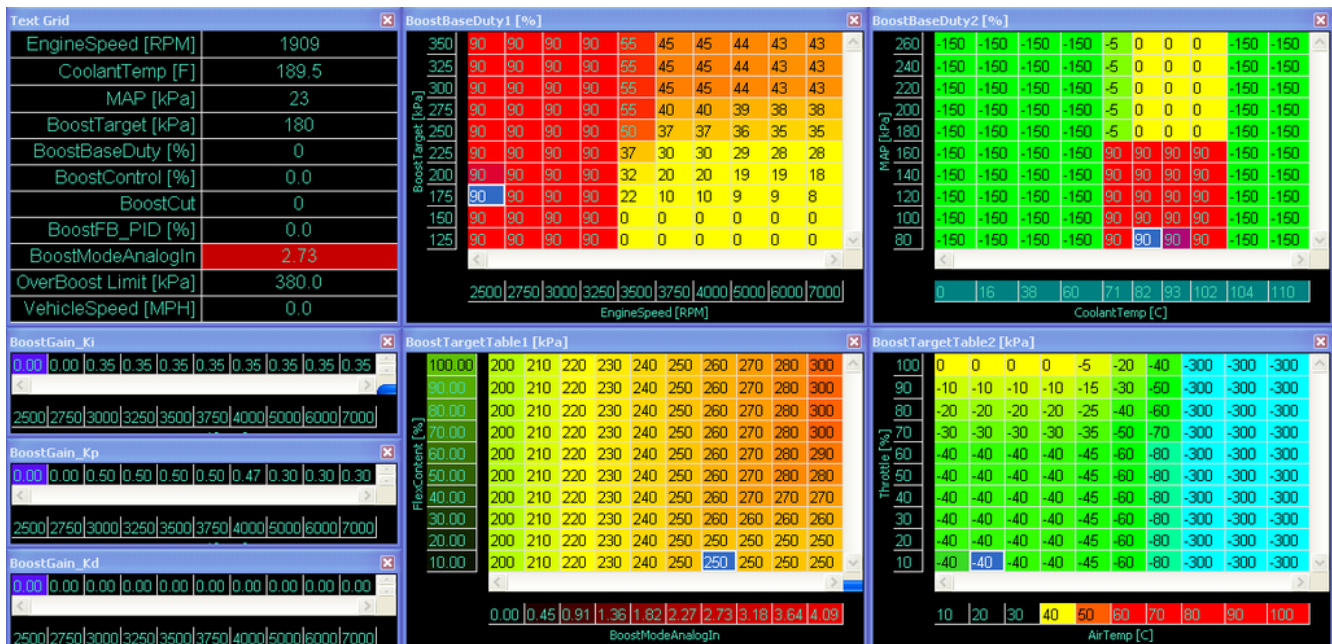

The example below is a boost strategy for a high horsepower, severely traction limited drag car that runs on varying mixes of Ethanol. Boost compensated for changes in baro pressure (weather, altitude, etc) and changes in exhaust backpressure. Typically, higher duty cycle is needed to retain boost level as baro pressure is reduced and EBP is increased. However, due to the Infinity's advanced PID system, you could theoretically get away without having these sensors and still have consistent boost control by relying on boost feedback.

Failsafe strategies include injected pressure (this is the pressure delta between the fuel pressure and manifold pressure). On a manifold-pressure-referenced fuel pressure regulator, injected pressure should theoretically remain constant at all times, as the pressure regulator directly combats changes to manifold pressure by changing fuel pressure in a 1:1 ratio. However, if there is a pressure regulator failure, or a fuel flow issue (weak pump, restricted lines, etc) injected pressure can drop. The boost control is set up to automatically reduce boost in this condition. Side note: Due to the Infinity's model-based fuel calculations, any variation in injected pressure will also be compensated for in fueling.

You'll notice that the boost target increases with each gear, as it should. Also, with higher Ethanol contents, more boost can be run safely, but of course we only want this in the higher gears as we're traction limited. However, it was found on this car that higher ethanol contents (at the same boost level) caused an increase in torque due to the fuel/tuning, and this caused additional wheel spin. Therefore, boost target is actually reduced slightly in lower gears and higher ethanol contents to combat this tendency.

Text Grid

EngineSpeed [RPM]	920
CoolantTemp [F]	191.9
MAP [kPa]	44
BoostTarget [kPa]	180
BoostBaseDuty [%]	0
BoostControl [%]	0.0
BoostCut	0
BoostFB_PID [%]	0.0
BoostModeAnalogIn	2.72
OverBoost Limit [kPa]	380.0
VehicleSpeed [MPH]	0.0

BoostBaseDuty1 [%]

350	90	90	90	90	68	55	55	54	53	53
325	90	90	90	90	60	50	50	49	48	48
300	90	90	90	90	55	45	45	44	43	43
275	90	90	90	90	55	40	40	39	38	38
250	90	90	90	90	50	37	37	36	35	35
225	90	90	90	90	37	30	30	29	28	28
200	90	90	90	90	32	20	20	19	19	18
175	90	90	90	90	22	10	10	9	9	8
150	90	90	90	90	0	0	0	0	0	0
125	90	90	90	90	0	0	0	0	0	0

2000 3000 4000 5000 6000 7000 8000 9000 10000 11000

EngineSpeed [RPM]

BoostBaseDuty2 [%]

120	-10	-10	-10	-10	-10	-5	0	5	15	35
115	-10	-10	-10	-10	-10	-5	0	5	15	35
110	-10	-10	-10	-10	-10	-5	0	5	15	35
105	-5	-5	-5	-5	-5	0	5	10	20	40
100	0	0	0	0	0	5	10	15	25	45
95	5	5	5	5	5	10	15	20	30	50
90	10	10	10	10	10	15	20	25	35	55
85	15	15	15	15	15	20	25	30	40	60
80	15	15	15	15	15	20	25	30	40	60
75	15	15	15	15	15	20	25	30	40	60

80 100 140 180 220 260 300 340 380 420

EBPress [kPa]

BoostGain_Ki

0.00	0.00	0.35	0.35	0.35	0.35	0.35	0.35	0.35	0.35
------	------	------	------	------	------	------	------	------	------

2500 2750 3000 3250 3500 3750 4000 5000 6000 7000

BoostTargetTable1 [kPa]

100	140	140	190	250	320	320	320	320	320	320
90	140	140	190	250	320	320	320	320	320	320
80	140	140	190	250	320	320	320	320	320	320
70	140	140	190	250	320	320	320	320	320	320
60	140	140	190	250	300	300	300	300	300	300
50	140	140	190	250	280	280	280	280	280	280
40	145	145	195	250	260	260	260	260	260	260
30	150	150	200	240	240	240	240	240	240	240
20	150	150	200	230	230	230	230	230	230	230
10	150	150	200	230	230	230	230	230	230	230

0 1 2 3 4 5 6 7 8 9

Gear

BoostTargetTable2 [kPa]

45	0	0	0	-5	-15	-35	-100	-300	-300	-300
43	0	0	0	-5	-15	-35	-100	-300	-300	-300
41	0	0	0	-5	-15	-35	-100	-300	-300	-300
39	-50	-50	-50	-55	-65	-85	-150	-300	-300	-300
37	-100	-100	-100	-105	-115	-135	-300	-300	-300	-300
34	-300	-300	-300	-300	-300	-300	-300	-300	-300	-300
31	-300	-300	-300	-300	-300	-300	-300	-300	-300	-300
29	-300	-300	-300	-300	-300	-300	-300	-300	-300	-300
27	-300	-300	-300	-300	-300	-300	-300	-300	-300	-300
25	-300	-300	-300	-300	-300	-300	-300	-300	-300	-300

10 20 30 40 50 60 70 80 90 100

AirTemp [C]

BoostGain_Kp

0.00	0.00	0.50	0.50	0.50	0.50	0.47	0.30	0.30	0.30
------	------	------	------	------	------	------	------	------	------

2500 2750 3000 3250 3500 3750 4000 5000 6000 7000

BoostGain_Kd

0.00	0.00	0.00	0.00	0.00	0.00	0.00	0.00	0.00	0.00
------	------	------	------	------	------	------	------	------	------

2500 2750 3000 3250 3500 3750 4000 5000 6000 7000

Engine Protection

AEM Infinity-10

Basic Setup

- Engine
- Tuning Preferences
- Cam/Crank
- Injector Setup
- Basic Sensors
- DBW Tuning
- Set Throttle Range
- Ignition Sync

Advanced Setup

- Accel and Decel Fuel
- Boost Control
- Engine Protection**
- Fuel Trims
- Idle
- Input Function Assignments
- Knock Setup
- Lambda Control
- Launch Antilag
- Launch Timer
- Nitrous N2O
- Main Rev Limiter
- Rev Limit 2 Step
- Rev Limit 3 Step
- Shift Cut
- Traction Control
- USB Logging
- VVC
- Diagnostics

Outputs

Engine Protection

The ECU can cut fuel and/or spark to prevent engine damage during overboost, low oil pressure, and lean conditions. Use the Engine Protection Wizard to set criteria for which the Engine Protection will respond.

Overboost Protection

Max Boost Limit kPa
ECU will cut fuel and spark if boost ever exceeds this value.

OverBoost Allowed kPa
ECU will cut fuel and spark if boost exceeds the Boost Target by this much.

Throttle Position Reset %
After BoostCut has been triggered, it will remain active until boost decreases to a safe level and the throttle is decreased below this value.

Oil Pressure Protection Basic Setup

The minimum allowable oil pressure must be defined using the 1D table 'OilPressProtectTable [psig]'. If the measured pressure remains lower than the value in the table for longer than the 'Oil Pressure Protection Activation Delay' time, the ECU will activate the 'Oil Pressure Protection Rev Limit'.

Oil Pressure Protection Enable

Oil Pressure Protection Activation Delay s

Oil Pressure Protection Rev Limit rpm

Lean Protection Basic Setup

Lambda 1 Protection Enable

Lambda 2 Protection Enable

Lean Protect on Sensor Error

Lean Fuel Cut Enable

Lean Spark Cut Enable

Lean Protection Minimum Engine Speed rpm

Lean Protection Minimum Throttle %

Lean Protection Activation Delay ms

Lean Protect Rev Limit rpm

Close

v2.96 Build 10/14/2014

Overboost Protection

The overboost protection feature has two different ways of limiting engine damage from an overboost condition. Two cut limits are configurable and the system will select the resultant **lowest** boost cut MAP value.

Max Boost Limit:

A 100% fuel cut will be activated if manifold pressure in [kPa] exceeds this value regardless of the target boost value.

Overboost Allowed:

Useful for multi fuel setups where the user has a varying boost target that depends on ethanol content. The fuel cut will be dynamic and dependent on the target boost.

Cut activated at a manifold pressure value of: BoostTarget [kPa] + Overboost Allowed [kPa]

Oil Pressure Protection Basic Setup

The oil pressure protection strategy uses the following options along with the OilPressProtectTable. This is typically used to activate a light, buzzer, etc.

Oil Pressure Protection Enable:

Enable and disables the oil pressure protection feature

Oil Pressure Protection Activation Delay:

Conditions must be present for this amount of time before protection function activates

Oil Pressure Protection Rev Limit:

Target RPM limit while oil pressure protection active

Lean Protection Basic Setup

The lean protection basic strategy uses the following conditions to cut fuel and/or spark in order to prevent the engine from getting too lean and causing detrimental problems.

Lambda 1 Protection Enable:

Enable and disables the Lambda 1 protection feature

Lambda 2 Protection Enable:

Enable and disables the Lambda 2 protection feature

Lean Protect on Sensor Error:

Enable and disables the Lean Protect if the sensor is in Error Mode.

Lean Fuel Cut Enable:

Enable and disables the Lean Fuel Cut feature

Lean Spark Cut Enable:

Enable and disables the Lean Spark Cut feature

Lean Protection Minimum Engine Speed (RPM):

Only lean conditions above this set engine speed will be monitored for the lean protection feature.
Min value = 0, Max value = 20000, Resolution = 1.0

Lean Protection Minimum Throttle (%):

Only lean conditions above this set throttle position will be monitored for the lean protection feature.
Min value = 0, Max value = 100, Resolution = 1.0

Lean Protection Activation Delay:

This can be used to cancel out any false spikes caused by excessive EMI signal noise.

Min value = 0, Max value = 2000, Resolution = 1.0

Lean Protect Rev Limit (RPM):

This sets the engine speed limit when the lean protection is triggered.

Min value = 0, Max value = 20000, Resolution = 1.0

Oil Press Protect Table

Units: Pressure vs RPM

Description: This table allows users to protect the engine from low oil pressure. Note that an oil pressure sensor must be installed. Most OEM vehicles come standard with an oil pressure switch which is not as useful. To set all of the conditions related to the oil pressure protection strategy, go to [Engine Protection](#)¹⁵⁸.

20.0	20.0	40.0	50.0	60.0	70.0	80.0	100.0	100.0	100.0
0.0	1000.0	2000.0	3000.0	4000.0	5000.0	6000.0	7000.0	8000.0	9000.0
EngineSpeed [RPM]									

Lean Protect Table

Units: Lambda vs MAP

Description: This table allows the user to protect the engine from a lean fuel mixture when under high engine load. To set all of the conditions related to the lean protection strategy, go to [Engine Protection](#)¹⁵⁸.

1.1	1.1	1.0	0.9	0.9	0.9	0.9	0.9	0.9	0.9
50.0	80.0	100.0	125.0	150.0	175.0	200.0	225.0	250.0	300.0
MAP [kPa]									

Coolant Protect RPM Limit Table

Units: RPM vs Coolant Temp

Description: This table allows the user to preset an engine limiter based on coolant temperature just like many OEM vehicles use. The assumption is that if the coolant temperature is low, the oil temperature is most likely low as well. Oil viscosity is drastically affected by oil temperature.

4000.0	4000.0	5000.0	6000.0	6000.0	6000.0	6000.0	5000.0	4000.0	0.0
0.0	20.0	40.0	60.0	80.0	90.0	100.0	110.0	115.0	120.0
CoolantTemp [C]									

Oil Temp Protect RPM Limit Table

Units: RPM vs Oil Temp

Description: This table allows the user to preset an engine limiter based on oil temperature. Oil viscosity is drastically affected by oil temperature.

OilTempProtect [RPM]									
15000	15000	15000	15000	15000	15000	15000	15000	15000	15000
OilTemp [F]									
32.0	68.0	104.0	140.0	176.0	212.0	248.0	266.0	284.0	302.0

Idle - Basic

Basic Setup

- Engine
- Tuning Preferences
- Cam/Crank
- Injector Setup
- Basic Sensors
- DBW Tuning
- Set Throttle Range
- Ignition Sync

Advanced Setup

- Accel and Decel Fuel
- Boost Control
- Engine Protection
- Fuel Trims
- Idle**
- Input Function Assignments
- Knock Setup
- Lambda Control
- Launch Antilag
- Launch Timer
- Nitrous N2O
- Main Rev Limiter
- Rev Limit 2 Step
- Rev Limit 3 Step
- Shift Cut
- Traction Control
- USB Logging
- WVC
- Diagnostics

Outputs

- Output Function Assignme...

Idle

The idle controller uses lookup tables to determine the idle RPM based on time after starting, coolant temperature, and engine speed rate of change. Feedback is used to maintain the target idle RPM when idle is active. Use the Idle setup wizard to set idle parameters, including Idle Activation Criteria and Idle Control Limits. Use the Advanced Setup to modify the Idle Offsets, Max Position/Steps, and Airflow Invert.

Idle Activation Criteria

Idle On Below TPS: %

When using drive-by-wire, note that this will disable idle feedback based on the APP1 signal.

Idle On Below RPM: rpm

Idle Feedback Min: %

Idle Feedback Max: %

[▶ Show Advanced Setup](#)

Idle Activation Criteria:**Idle On Below TPS [%]:**

Closed-loop idle feedback will be active when the throttle position is below this value, and the 'Idle On Below RPM' condition is also met.

Min value = 0, Max value = 10

Idle On Below RPM [RPM]:

Closed-loop idle feedback will be active when the EngineSpeed is below this value, and the 'Idle On Below TPS' condition is also met.

Min value = 500, Max value = 3000

Idle Feedback Min [%]:

Minimum amount of correction allowed

Min value = -50, Max value = 0

Idle Feedback Max [%]:

Maximum amount of correction allowed

Min value = 0, Max value = 50

Idle – Advanced

Hide Advanced Setup

The Advanced Setup allows the user to modify the Idle PID feedback gains: Proportional (instantaneous error), Integral (sum of errors), and Derivative (error rate of change). Adjusting the feedback gains will affect the response time, accuracy, and stability of the control loop. Gains that are set too small can result in sluggish response to changing engine speeds, while gains set too large can result in overshooting, oscillations, and overall idle instability.

Idle Proportional Gain

Idle Integral Gain

Idle Derivative Gain

Idle FB Deadband +

Idle FB Deadband -

Idle AC Offset and Idle Coolant Fan Offset can be used to compensate for additional airflow required when the AC compressor or Radiator Fan is active. Idle Stepper Max Steps defines the mechanical range of the stepper idle valve, if this is set too high the ECU will seem to 'lose track' of the idle after the engine has been running for a longer period of time. Idle Airflow Invert should be adjusted so that higher values in the IdleBaseDuty table increase the amount of airflow to the engine.

Idle AC Offset

Idle Coolant Fan Offset

Idle Offset RPM and Idle Offset Time are used to help prevent idle target undershoot when engine speed is falling quickly. When engine speed falls into idle range, the Idle Offset RPM value will be added to the idle target for the specified Idle Offset Time.

Idle Offset RPM rpm

Idle Offset Time s

Idle Stepper max steps %

Idle Airflow Invert

Advanced Setup:

Idle Proportional Gain:

Proportional control is a pure gain adjustment acting on the magnitude of the target error to provide the system response. The advantage of a proportional-only control is it can respond quickly to large errors; when the error is large the proportional response will be large. The disadvantage of proportional gain for idle control is the proportional response will decrease to zero as the engine speed gets closer to the idle target RPM, and this tends to result in 'hunting' or fluctuations in engine speed. It is recommended to begin tuning idle feedback with this value set to zero or very low values. If the system responds too slowly to quick disturbances, increase this value slightly.

Min value = 0.000, Max value = 1.000

Idle Integral Gain:

Integral control uses an integrator or 'accumulator' method, essentially checking if the target error is positive or negative and then taking one step up or one step down every 400ms to reduce the target error. The advantage of integral response for idle control is the idle airflow will be slowly and smoothly adjusted until the engine speed reaches the target, and then remain at whatever feedback value reached the target.

Note: Although Integral gain is less likely to cause hunting or fluctuations than Proportional or Derivative gains, excessively high Integral values will take steps that are too large which can result in instability.

Min value = 0.000, Max value = 1.000

Idle Derivative Gain:

The derivative term adjusts the feedback based on the rate of change of the target error. Derivative control is used to reduce the magnitude of the overshoot produced by the Proportional component and improve the combined controller-process stability. Note: for most setups, it is recommended to leave the Derivative gain set to zero. For tuners who are very familiar with PID feedback and are observing a situation that could be alleviated by adjusting Derivative gain, it is recommended to use the Idle_Decel table rather than the Derivative gain.

Min value = 0.000, Max value = 1.000

Idle FB Deadband:

The idle airflow valve is not the only factor that can influence engine speed and idle stability. In some cases, changing idle airflow in response to the engine's natural instability will cause the engine to fluctuate even more than if the idle valve were locked at a constant position. The Idle feedback deadband range defines an operating window where the engine speed is considered to be 'close enough' to the idle target and the IdleFB value should be paused. This deadband range should be larger for engines that do not idle smoothly, such as setups including aggressive camshafts, lightweight flywheels, or fuel injectors that flow inconsistently when operated at small pulsewidths.

Idle FB Deadband +:

Within this range above the target idle RPM, idle feedback is paused and additional feedback will not be calculated.

Min value = 0 RPM, Max value = 300 RPM

Idle FB Deadband -:

Within this range below the target idle RPM, idle feedback is paused and additional feedback will not be calculated.

Min value = -300 RPM, Max value = 0 RPM

Idle Offsets:**Idle AC Offset:**

When the Air Conditioning system is activated, the compressor and/or fan will put an additional load on the engine. Idle AC Offset increases the open-loop idle air control valve position when the air conditioning clutch is active. When this value is adjusted properly, the engine speed should not decrease significantly when the compressor cycles ON, and should not flare high when the compressor turns OFF. When this value is not set correctly, the IdleFB value may fluctuate significantly when the AC compressor turns on or off.

Min value = 0, Max value = 50

Idle AC Target Offset:

For low-powered engines, it can be helpful to increase the target idle RPM to prevent stalling while the AC is enabled.

Min value = 0 RPM, Max value = 1000 RPM

Idle Coolant Fan Offset:

When the coolant fan is activated, the alternator will put an additional load on the engine. Idle AC Offset increases the open-loop idle air control valve position when the coolant fan function is active. When this value is adjusted properly, the engine speed should not decrease significantly when the compressor cycles ON, and should not flare high when the compressor turns OFF.

Min value = 0, Max value = 50

When idle feedback turns on, there is a good chance the engine is decelerating down into the idle conditions. To allow the engine to settle down to idle gracefully, the idle target RPM will be temporarily increased by the 'Idle Offset RPM' value, then decay down to the normal idle target after a short period of time.

Idle Offset RPM:

When idle feedback turns on, the idle target will increase by this amount.

Min value = 0 RPM, Max value = 1500 RPM

Idle Offset Time:

After idle feedback turns on, the Idle Offset RPM will slowly decay down to zero after this amount of time.

Min value = 0 seconds, Max value = 10 seconds

Idle Stepper Max Steps:

The number of physical steps the stepper idle valve is capable of moving without hitting its mechanical stop. See the **Idle Setup: Stepper Idle Valves** section of [Idle Air Control](#)¹¹⁸.

Min value = 0, Max value = 300

Idle Airflow Invert:

Some idle air control motors have an inverse relationship between position and airflow. In other words, 0% position results in maximum airflow and 100% position results in minimum airflow. If working with this type of air control valve, turning on 'Idle Airflow Invert' will invert the final step in the ECU's Idle calculations, 'Idle Position', so that vehicle's idle valve can work properly without requiring changes to the the vehicle's wiring harness.

Idle Decel

Units: Engine Speed Rate vs RPM vs Idle%

Description: This table allows an extra idle airflow offset to prevent the engine from stalling when decelerating down to idle. When the engine is decelerating quickly, the lower-right cells in this table will be used. These cells can be set to add airflow in order to slow the engine's deceleration 'on the way down' which makes the engine less likely to stall. This is especially helpful for vehicles with lightweight flywheels. Table values 300–800RPM above the target idle speed are the most important ones to adjust; increasing idle position when the engine reaches or drops below the target idle speed is generally too late.

EngineSpeed Rate	750	1000	1100	1500	2000	2500
0	0.0	0.0	0.0	0.0	0.0	0.0
-500	0.0	0.0	0.0	0.0	0.0	0.0
-1000	0.0	0.0	0.0	4.0	4.0	4.0
-1500	0.0	0.0	2.0	5.0	5.0	5.0

IgnTrimIdle

Units: Ignition timing trim vs Idle RPM error

Description: This table applies an ignition trim as a function of idle RPM error. Negative values retard ignition timing from the value in the main ignition map, which tends to decrease engine speed slightly. Positive values advance timing, which tends to increase engine speed slightly.

IdleRPM_error	-200	-150	-100	-50	0	50	100	150	200	250
	5.0	5.0	5.0	2.5	0.0	-2.5	-5.0	-5.0	-5.0	-5.0

IdleTargetOffset

Units: Idle Target Offset RPM vs After Start Time

Description: This table can be used to increase the target idle RPM for a few seconds after starting the engine. This will allow the catalytic converter to light off earlier for improved emissions and will also fight a lean mixture from excessive wall wetting from poor fuel injector atomization.



0.000	2.000	4.000	6.000	8.000	10.000
0	0	0	0	0	0

IdleTPSOffset

Units: Idle RPM Offset vs TPS

Description: This table offsets the idle target RPM at low throttle angles, to increase the desired idle speed when idle feedback may still be active. The values are offset from the **IdleTargetTable**.

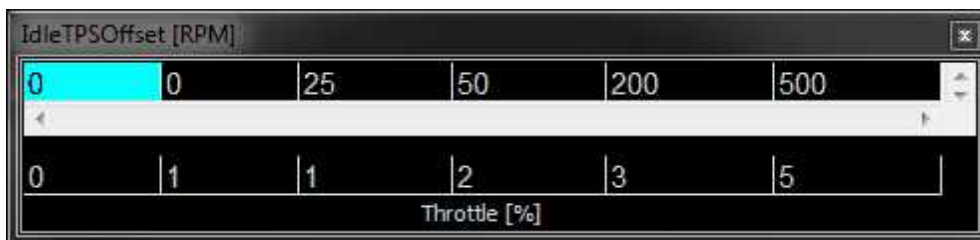

0	1	1	2	3	5
0	0	25	50	200	500

Idle Advanced Tuning:

If there are problems with **IdleFB** oscillations or response time, the feedback PID settings may need to be adjusted. Please understand that the original PID settings provided by AEM should be a good starting point for most vehicles, and adjusting the PID values by small amounts can create severe problems. It is recommended to first look into other potential problems if the engine does not idle smoothly, such as the VE table values, ignition timing, etc.

1. Set **Idle Proportional Gain**, **Idle Derivative Gain**, **Idle Integral Gain** values to zero. Also set the table values for **Idle_Decel** and **IgnTrimIdle** to zero. This will disable all idle feedback for airflow and ignition timing, which should result in a stable idle RPM assuming the mechanical load on the engine is not fluctuating due to the radiator fan, AC clutch, or vacuum leaks. Ensure that the fuel and ignition maps have been configured in a way that does not cause the engine to fluctuate or hunt. If idle feedback is disabled but the engine hunts and the measured Lambda values fluctuate, it's recommended to adjust the VETable values until measured Lambda is more smooth.
2. Log the channels **Engine Speed**, **IdleFB**, **IdlePosition**, and **IdleTarget**. Observe the amount of natural fluctuation without any idle feedback. It may be possible to reduce fluctuation by adjusting the values in the **IgnTrimIdle** table. Based on your logs, you can set reasonable values for the **IdleFB_Deadband+** and **IdleFB_Deadband-** limits.
3. Increase the **Idle Integral Gain** slowly, observing the effects on the IdleFB value calculated. Once the engine reaches the idle target RPM, put the transmission in gear and slowly begin release the clutch as if driving through the pits slowly. Watch that the idle feedback responds quickly enough to prevent the engine from stalling. If the O2 sensor reads lean when releasing the clutch, try increasing the **VEtable** values for the cells that are reached when the engine load increases. Repeat as necessary, adjusting Idle Integral Gain and possibly Idle Proportional Gain until you are satisfied with the idle feedback response to changes in engine load.
4. Press the throttle and hold at least 2500RPM for 1–2 seconds, then release the throttle so the engine decelerates down to idle. If the engine falls below the idle target RPM, first ensure that the **VEtable** is adjusted such that the O2 sensor does not read lean when decelerating the last 500–1000 RPM down to idle. After the VETable has been confirmed OK, adjust the values in the **Idle_Decel** table so the engine decelerates gradually near the idle target without overshooting or stalling. For some vehicles, values as large as 15 or 20 may be helpful in the Idle_Decel table. Repeat as necessary.
5. Press the throttle very gently so the position is 1-2-3-4% throttle. Watch idle feedback; if the feedback appears to be 'fighting' the throttle and trying to prevent the engine from accelerating when you press the throttle gently, you can decrease the '**Idle On Below TPS**' value so feedback is disabled sooner, or you can increase the values in the **IdleTPSOffset** table so the ECU's idle feedback does not 'fight' the throttle at very low angles.

Ignition Trim IDLE PID Feature:

Although not generally needed, a closed loop ignition trim for idle is now available. The following setup wizard settings are used to enable the feature.

Idle Ignition Proportional Gain	0.000
Idle Ignition Integral Gain	0.00
Idle Ignition Derivative Gain	0.000
Idle Ignition Min	-10.0
Idle Ignition Max	10.0

When enabled, this feedback control system will use closed loop ignition timing changes to help maintain a target idle.

Idle Feedback Disable Window Feature:

Idle Feedback Disable Window	2000	rpm
------------------------------	------	-----

Rather than using the 'Idle On Below RPM' option above, Idle feedback can be disabled when EngineSpeed is greater than the IdleBaseTarget by this much. Setting this value low can prevent idle feedback from calculating negative values while decelerating in gear.

Can be used in place of the Idle On Below RPM option. This is a more adaptive way of managing the idle target while decelerating in gear. It can prevent integral wind up and potential stalling problems when the clutch pedal is pushed in while coasting to a stop.

Input Function Assignments

Programmable inputs can be configured in the following window. Double clicking on a selection will open a more detailed interface where calibration data can be edited.

AEM Infinity-10

Input Function Assignments

Use the selections below to configure hardware inputs.

Analog 0-5V & Modes | Switches | Speed & Frequency | Temps | Axis

Function	Channel	Pin	Raw	Scaled
Charge Out Pressure Setup	Analog23 [V]	C2-36	4.99	345.00
Gear Position Input Setup	GearRatio		0.00	7.03
Lambda 3 Input Setup	Analog11 [V]	C1-39	5.00	1.36
Lambda 4 Input Setup	Analog10 [V]	C1-38	4.99	0.00
ModeSwitch Input Setup	ModeSwitch [V]		4.99	11.00
Barometric Pressure Sensor Setup	Analog10 [V]	C1-38	5.00	101.00
Exhaust Pressure Sensor Setup	Analog15 [V]	C2-20	5.00	101.00
Traction Control SlipTargetTrim Input Setup	TC_Switch_Latched		0.00	0.00

Pin Out...

Close

v2.96 Build 10/14/2014

Clicking the *Pin Out* button will display a pinout diagram showing the current configuration of the system. Inputs that are assigned to multiple functions will be highlighted for user reference. The user can optionally copy this information to the clip board or even print it.

AEM Infinity-6

Pin Out

Function	Input-Output	Pin
Lowside 3	LS3_HW	C1-22
AGND_1, Analog 0-5V sen...		C1-23
AGND_1, Analog 0-5V sen...		C1-24
Crankshaft Position Sensor...		C1-25
Camshaft 1 Position Senso...		C1-26
Digital in 2		C1-27
TurboSpeed_Sel	Dig3 [Hz]	C1-28
VSS_Dig_Sel	Dig3 [Hz]	C1-28
FlexContent [%]	Dig4 [Hz]	C1-29
BrakeSwitch	Digital5	C1-30
N2O_Switch	Digital5	C1-30
Digital in 6		C1-31
Digital in 7		C1-32
Power Ground		C1-33
CANL A out		C1-34
CANH A out		C1-35
CanH B out		C1-36
CanL B out		C1-37
CLT_sens [ohms]	Analog1_In_Temp	C1-38
AIT_sens [ohms]	Analog2_In_Temp	C1-39
OT_sens [ohms]	Analog3_In_Temp	C1-40
Lowside Fuel Pump Drive	LS0_HW	C1-41
Lowside 1	LS1_HW	C1-42
Power Ground		C1-43
Knock Sensor 1		C1-44
Knock Sensor 2		C1-45

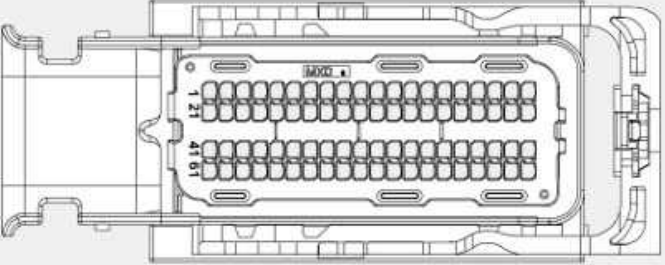

Warning: Pin out contains inputs assigned to multiple functions.

Copy to Clipboard Print Close

Function	Channel	Pin	Raw	Scaled
Charge Out Pressure Setup	Analog23 [V]	C2-36	0.00	101.00
Gear Position Input Setup	GearRatio		0.00	0.00
Lambda 3 Input Setup	Analog11 [V]	C1-39	0.00	0.00
Lambda 4 Input Setup	Analog10 [V]	C1-38	0.00	0.00
ModeSwitch Input Setup	ModeSwitch [V]		0.00	0.00
Barometric Pressure Sensor Setup	Analog10 [V]	C1-38	0.00	101.00
Exhaust Pressure Sensor Setup	Analog15 [V]	C2-20	0.00	101.00
Traction Control SlipTargetTrim Input Setup	Analog14 [V]	C2-19	0.00	0.00

All user configurable 0-5V analog inputs can be setup from this window.

This wizard defines the calibration settings for the Charge Out Pressure input [Live Data](#)

Raw	Scaled
0.00	101.00

Charge Out Pressure Setup

CP Cal Min	<input type="text" value="0.00"/>	kPa
CP Cal Max	<input type="text" value="345.00"/>	kPa
CP Volts Min	<input type="text" value="0.50"/>	V
CP Volts Max	<input type="text" value="4.50"/>	V

Charge Out Pressure Setup:

Input selector for Charge Out Pressure. Note: Only one option may be available depending on which pakgrp is loaded.

CP Volts Min:

This sets the minimum voltage capable from a properly working sensor. Check the manufacturer specifications for more information. Min value = 0, Max value = 5. CP Volts Min must be < CP Volts Max. User entries that do not meet this criteria are not allowed.

CP Volts Max:

This sets the minimum voltage capable from a properly working sensor. Check the manufacturer specifications for more information. Min value = 0, Max value = 5. CP Volts Min must be < CP Volts Max. User entries that do not meet this criteria are not allowed.

CP Cal Min:

This sets the minimum pressure capable, in kPa, from a properly working sensor. Check the manufacturer specifications for more information. Min value = 0, Max value = 1300. CP Cal Max must be > CP Cal Min. User entries that do not meet this criteria are not allowed.

CP Cal Max:

This sets the minimum pressure capable, in kPa, from a properly working sensor. Check the manufacturer specifications for more information. Min value = 0, Max value = 1300. CP Cal Max must be > CP Cal Min. User entries that do not meet this criteria are not allowed.

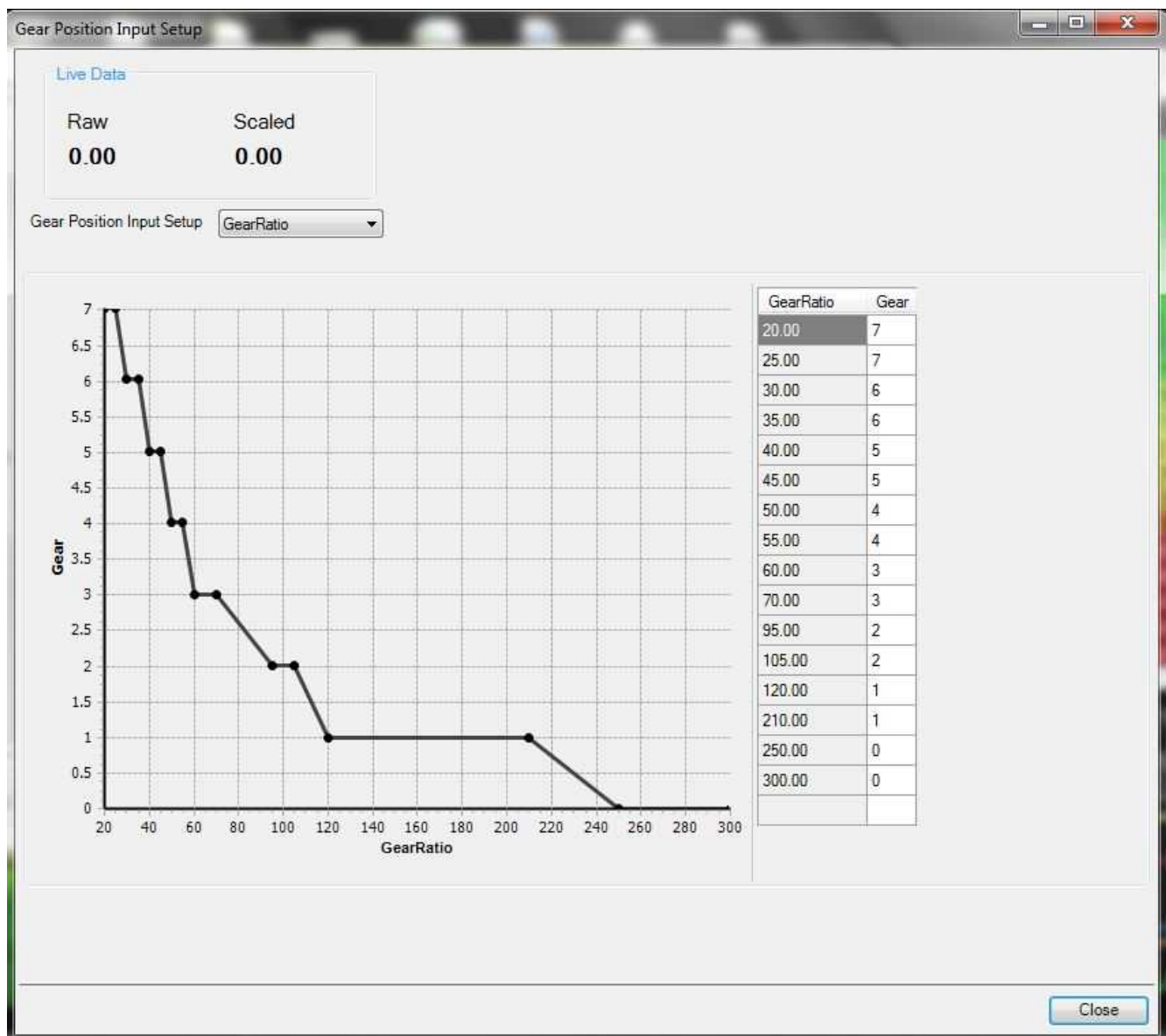

Gear Position Input Setup:

Select the input to be used for the gear position calculation. The 1D table Gear can be used to transform the data into a Gear channel.

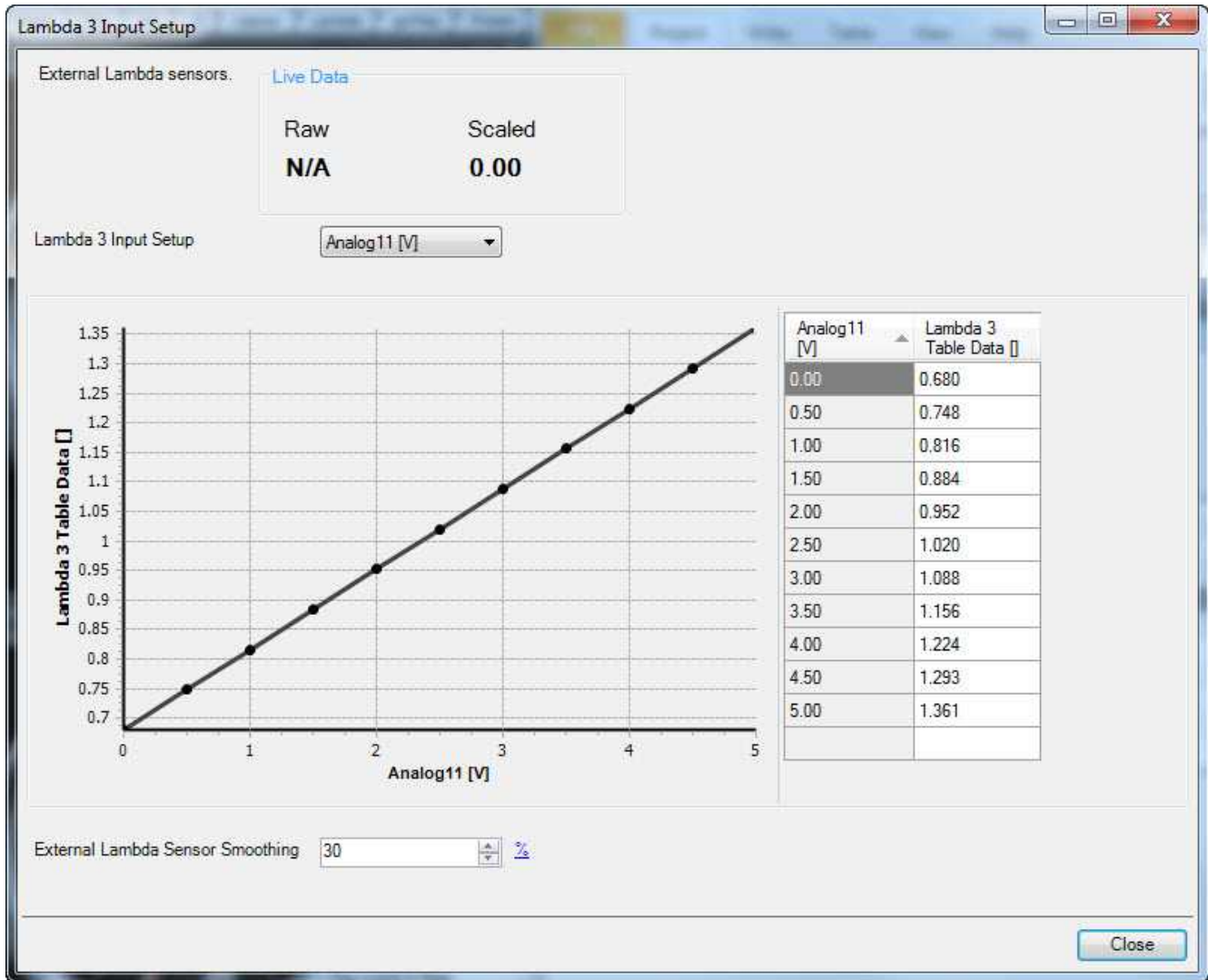
**Lambda 3 Input Setup:**

Select the input to be used for the Lambda 3 channel. The 1D table Lambda3Cal can be used to calibrate the data.

External Lambda Sensor Smoothing:

A filter value to smooth noisy signals. The higher the value the more smoothing applied

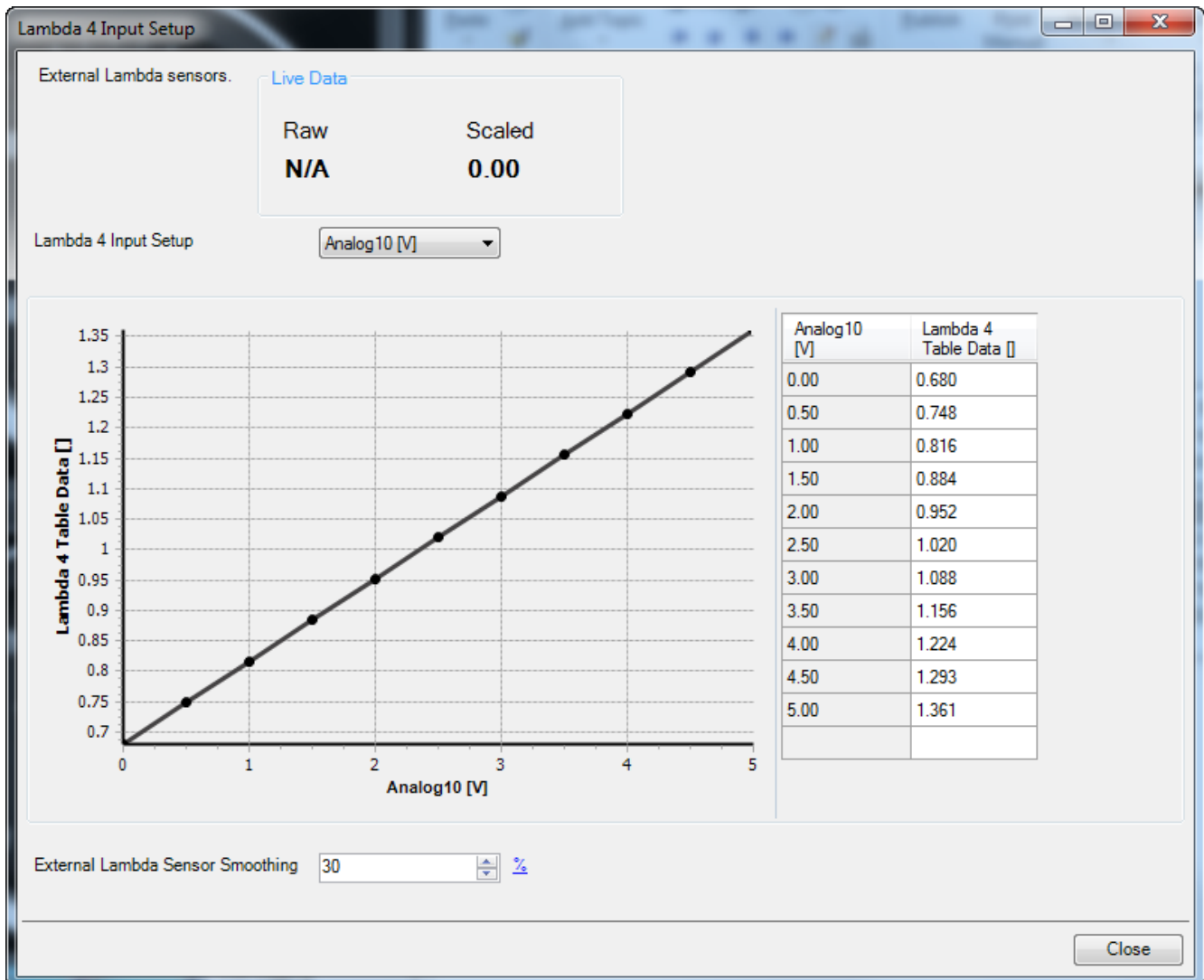
**Lambda 4 Input Setup:**

Select the input to be used for the Lambda 4 channel. The 1D table Lambda4Cal can be used to calibrate the data.

External Lambda Sensor Smoothing:

A filter value to smooth noisy signals. The higher the value the more smoothing applied

Live Data

Raw

0.00

Scaled

0.00

ModeSwitch Input Setup

ModeSwitch [V]

ModeSwitch 0-5V Analog Input Selection

Analog12 [V]

▼Hide ModeSwitch Position Setup

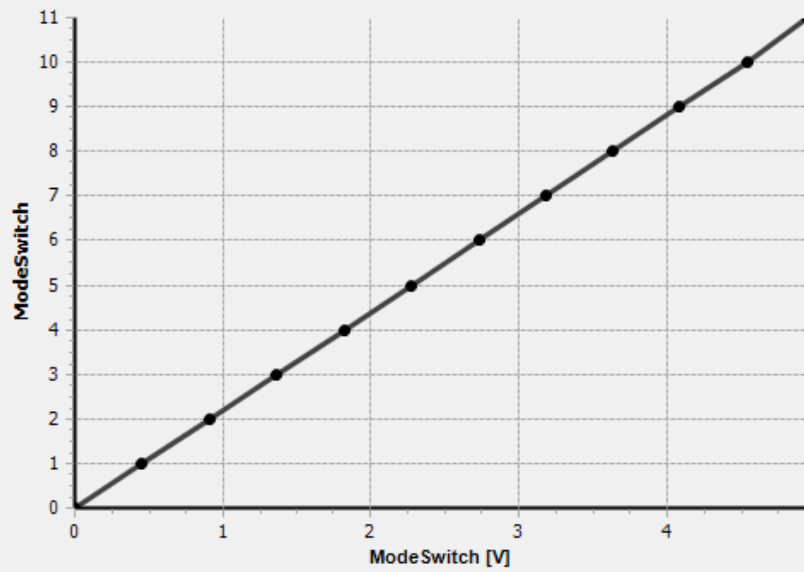

ModeSwitch [V]	ModeSwitch
0.00	0
0.45	1
0.91	2
1.36	3
1.82	4
2.27	5
2.73	6
3.18	7
3.64	8
4.09	9
4.55	10
4.95	11

Mode Switch Input Setup:

Select the input to be used for the Mode Switch channel. The 1D table ModeSwitch can be used to calibrate the data.

This wizard enters the correct Barometric Pressure Sensor Max Volts, MAP Min Volts, Load Offset and Load Scalar. This input cannot be reassigned.

[Live Data](#)

Raw	Scaled
0.00	101.00

Barometric Pressure Sensor Setup Analog10 [V]

Sensor Selection:

No wizard is selected or matched. Click the Browse button to select one.

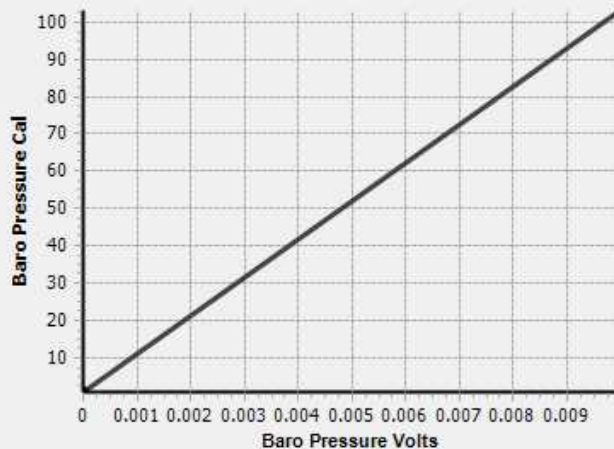

Baro Pressure Cal Min 1.0 kPa

Baro Pressure Cal Max 103.0 kPa

Baro Pressure Volts Min 0.00 V

Baro Pressure Volts Max 0.01 V

Baro Pressure Sensor Installed

Baro Pressure Smoothing 60 %

Baro Pressure Failsafe On

Baro Pressure Failsafe 101.0 kPa

Barometric Pressure Sensor Setup

Select input for barometric pressure sensor.

Baro Pressure Wizard Selection

Selecting this box will present a menu with multiple pre configured barometric pressure sensors to choose from.

Baro Pressure Min Volts:

This sets the minimum voltage capable from a properly working sensor. Check the manufacturer specifications for more information. Min value = 0, Max value = 5. Baro Pressure Max Volts must be > Baro Pressure Min Volts. User entries that do not meet this criteria are not allowed.

Baro Pressure Max Volts:

This sets the maximum voltage capable from a properly working sensor. Check the manufacturer specifications for more information. Min value = 0, Max value = 5. Baro Pressure Max Volts must be > Baro Pressure Min Volts. User entries that do not meet this criteria are not allowed.

Baro Pressure Cal Min [psig]:

This sets the minimum pressure capable, in psig, from a properly working sensor. Check the manufacturer specifications for more information. Min value = 0, Max value = 125. Baro Pressure Cal Max must be > Baro Pressure Cal Min. User entries that do not meet this criteria are not allowed.

Baro Pressure Cal Max [psig]:

This sets the maximum pressure capable, in psig, from a properly working sensor. Check the manufacturer specifications for more information. Min value = 0, Max value = 125. Baro Pressure Cal Max must be > Baro Pressure Cal Min. User entries that do not meet this criteria are not allowed.

Baro Pressure Sensor Installed

If a barometric pressure sensor is installed, check this box.

Baro Pressure Smoothing

Value used to smooth signal. Min value = 0, Max value = 98.

Baro Pressure Failsafe On:

When clicking, the failsafe feature is enabled. This is typically used when the sensor is mistakenly unplugged or has failed.

Baro Pressure Failsafe:

The value entered here will be displayed and used for the barometric pressure corrections when the sensor has failed or is simply unplugged. Min value = 0, Max value = 125

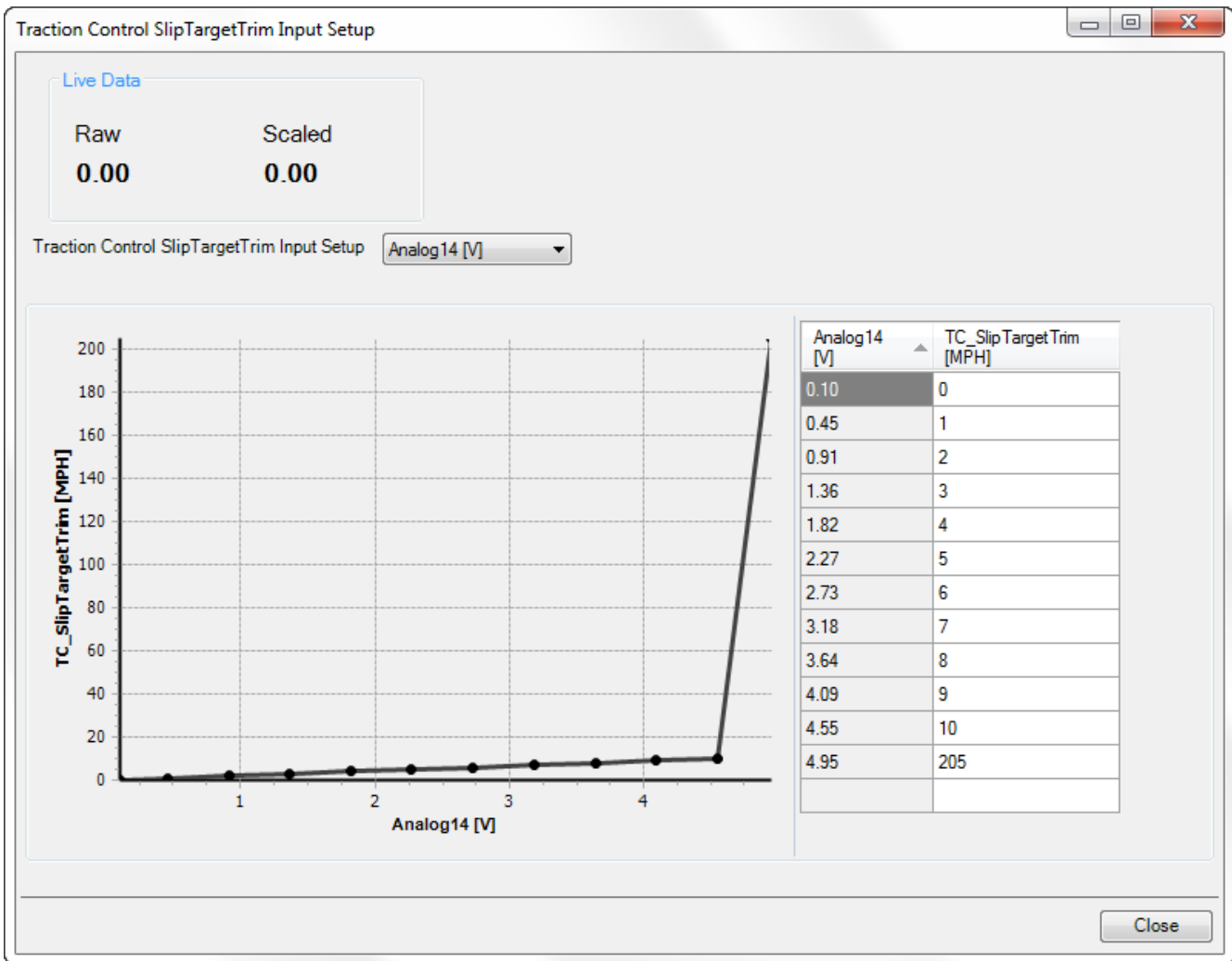

Traction Control Slip Target Trim Input Setup:

Select the input to be used for the Slip Target Trim Input. The 1D table TC_SlipTargetTrim [MPH] can be used to calibrate the data.

Function	Channel	Pin	Raw	Scaled
3-Step Switch Setup	Analog21 [V]	C2-34	0.00	0.00
AC Request Switch Setup	Analog16 [V]	C2-21	0.00	0.00
Clutch Switch Setup	Digital6	C2-37	0.00	0.00
Shift Switch Setup	Analog11 [V]	C1-39	0.00	0.00
Brake Switch Setup	Digital6	C2-37	0.00	0.00
MIL Manual Trigger Switch Setup	Analog16 [V]	C2-21	0.00	0.00
Nitrous Arm Switch Setup	Digital6	C2-37	0.00	0.00

All user configurable switch inputs can be setup from this window.

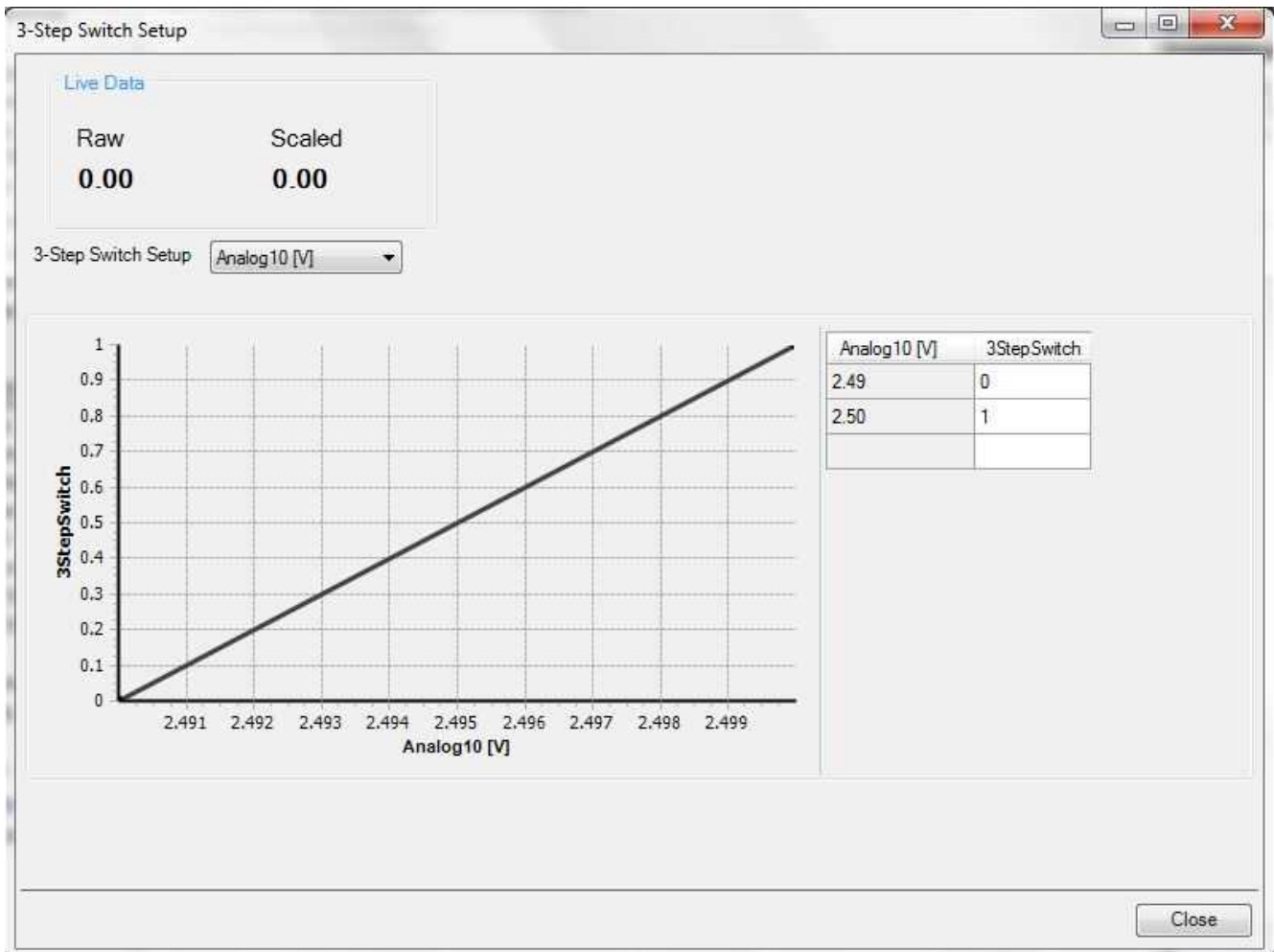

Choose the input channel from the available selections in the drop down list. Use the table to define the logic output. In the example above, the two breakpoints are used to define a function where the input is OFF below 2.49 volts and ON above 2.50 volts.

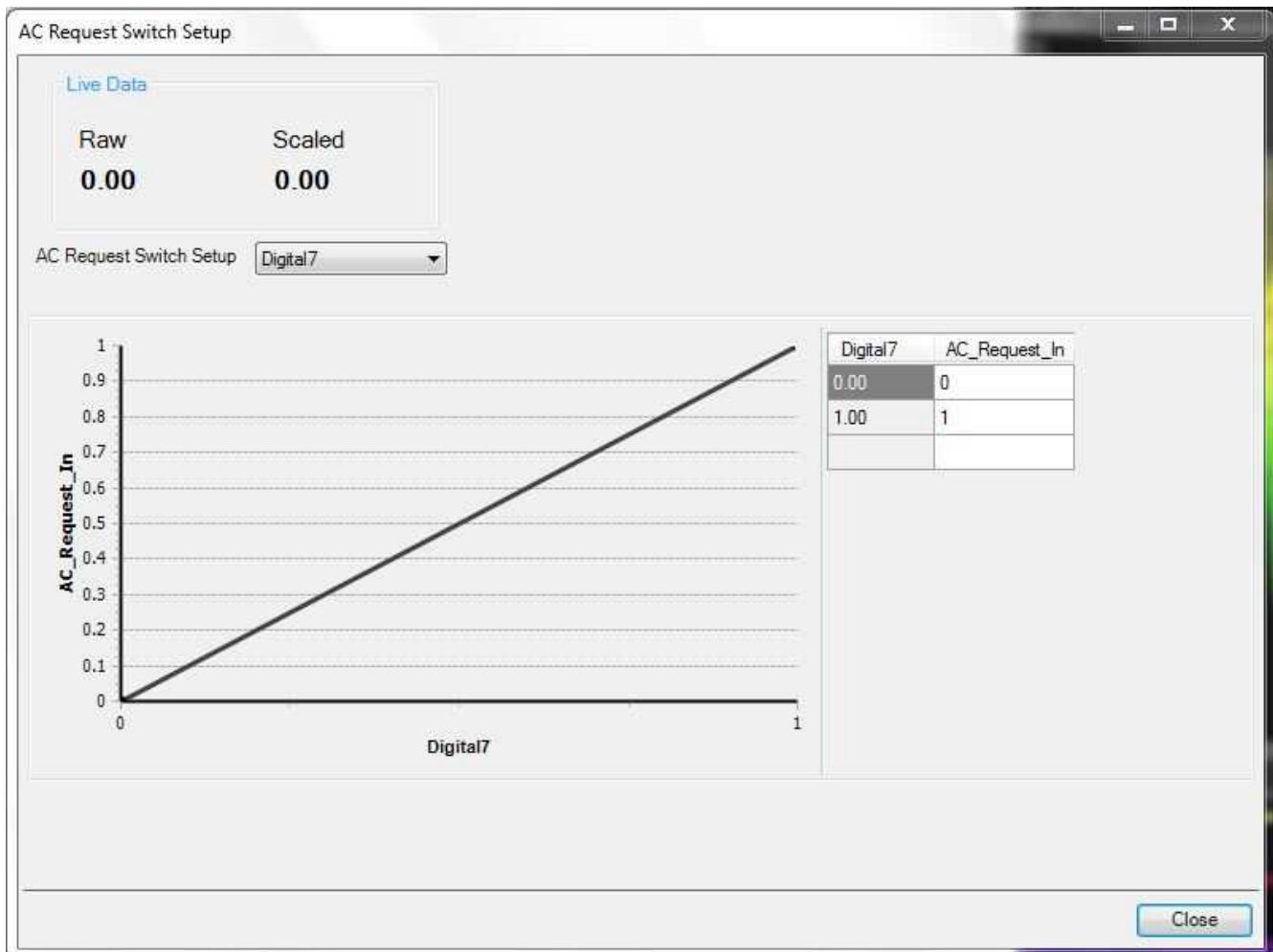

Choose the input channel from the available selections in the drop down list. Use the table to define the logic output. In the example above, the two breakpoints are used to define a function where the input is OFF when the digital input pin state is low '0' and ON when the digital input pin state is high '1'. The logic can be inverted by simply swapping the values in the AC_Request_In column.

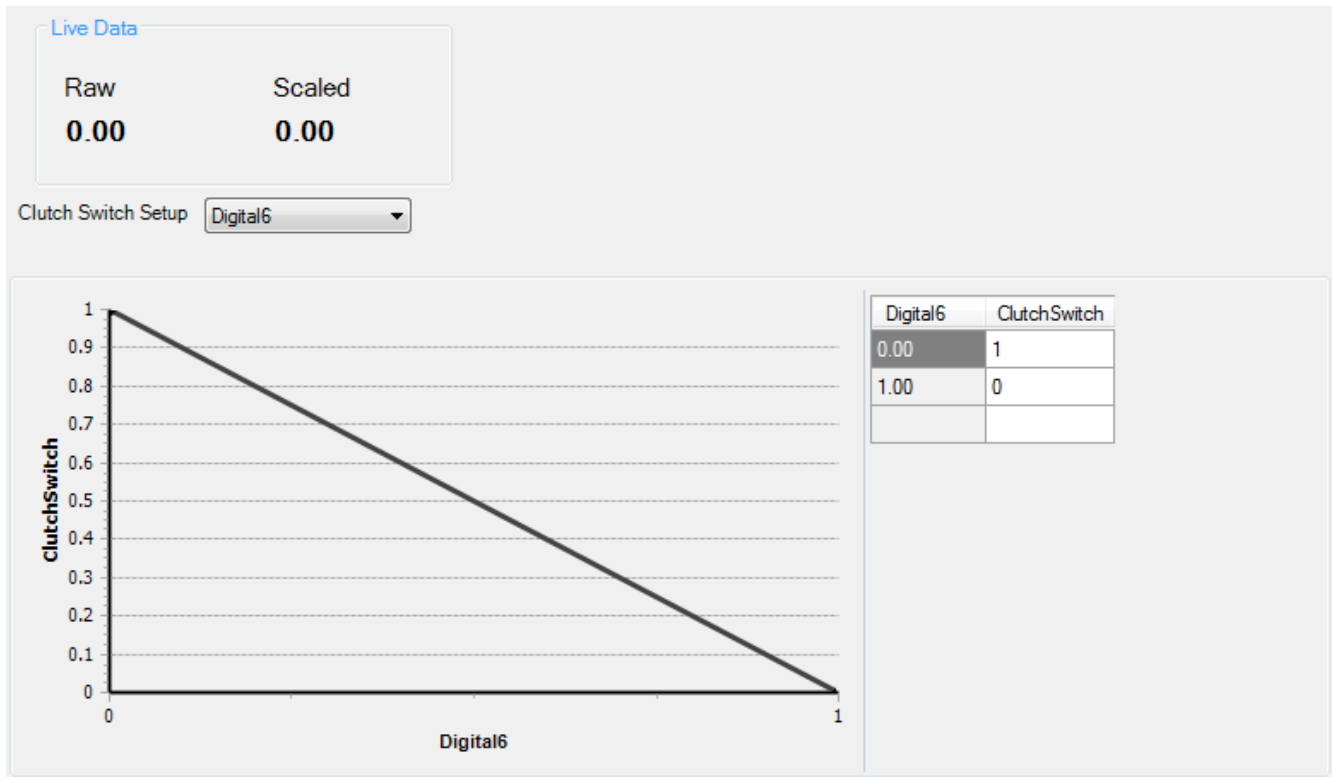

Choose the input channel from the available selections in the drop down list. Use the table to define the logic output. In the example above, the two breakpoints are used to define a function where the input is ON when the digital input pin state is low '0' and OFF when the digital input pin state is high '1'. The logic can be inverted by simply swapping the values in the ClutchSwitch column.

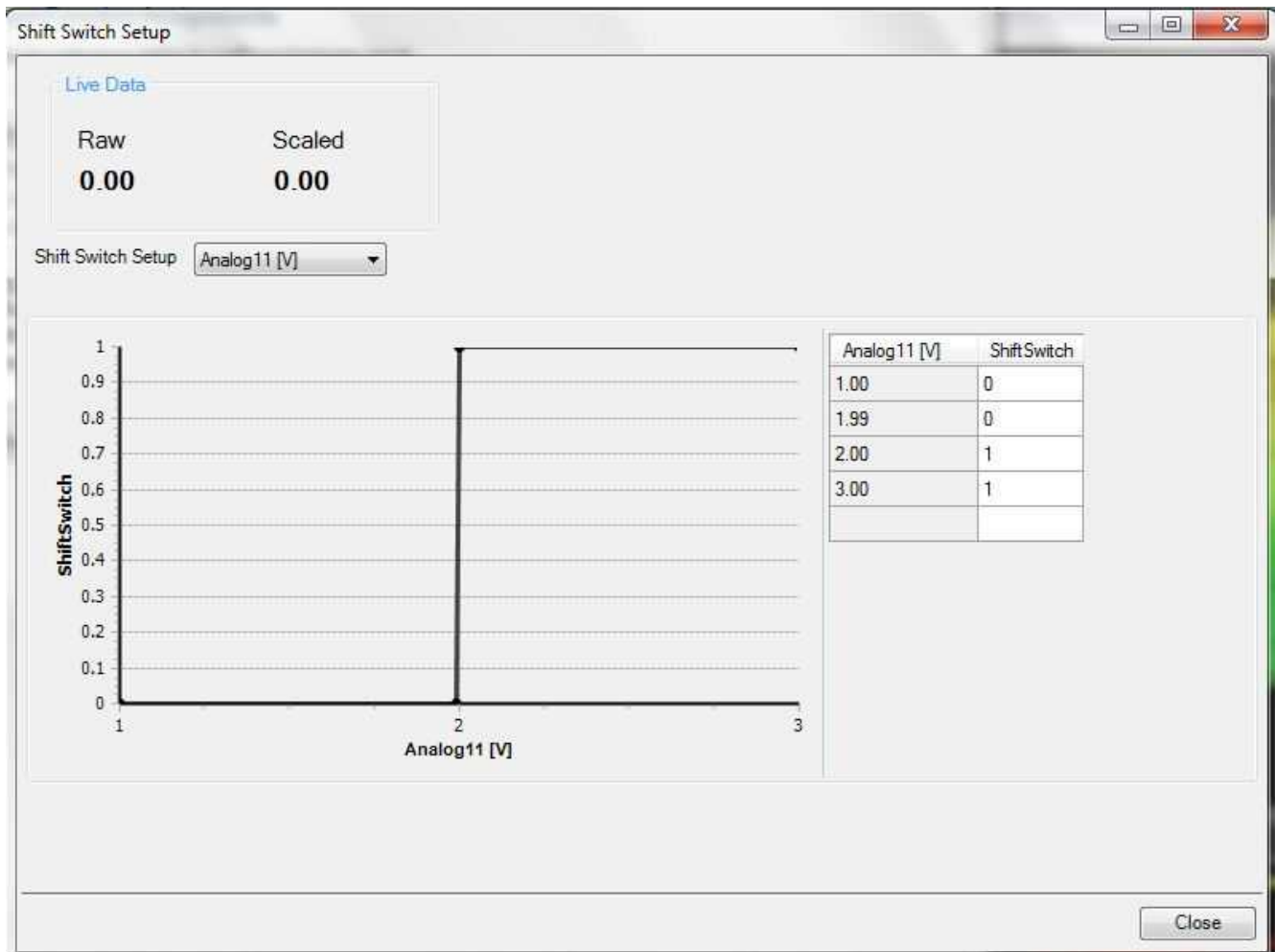

Choose the input channel from the available selections in the drop down list. Use the table to define the logic output. In the example above, the breakpoints are used to define a function where the input is OFF below 1.99 volts and ON above 2.00 volts.

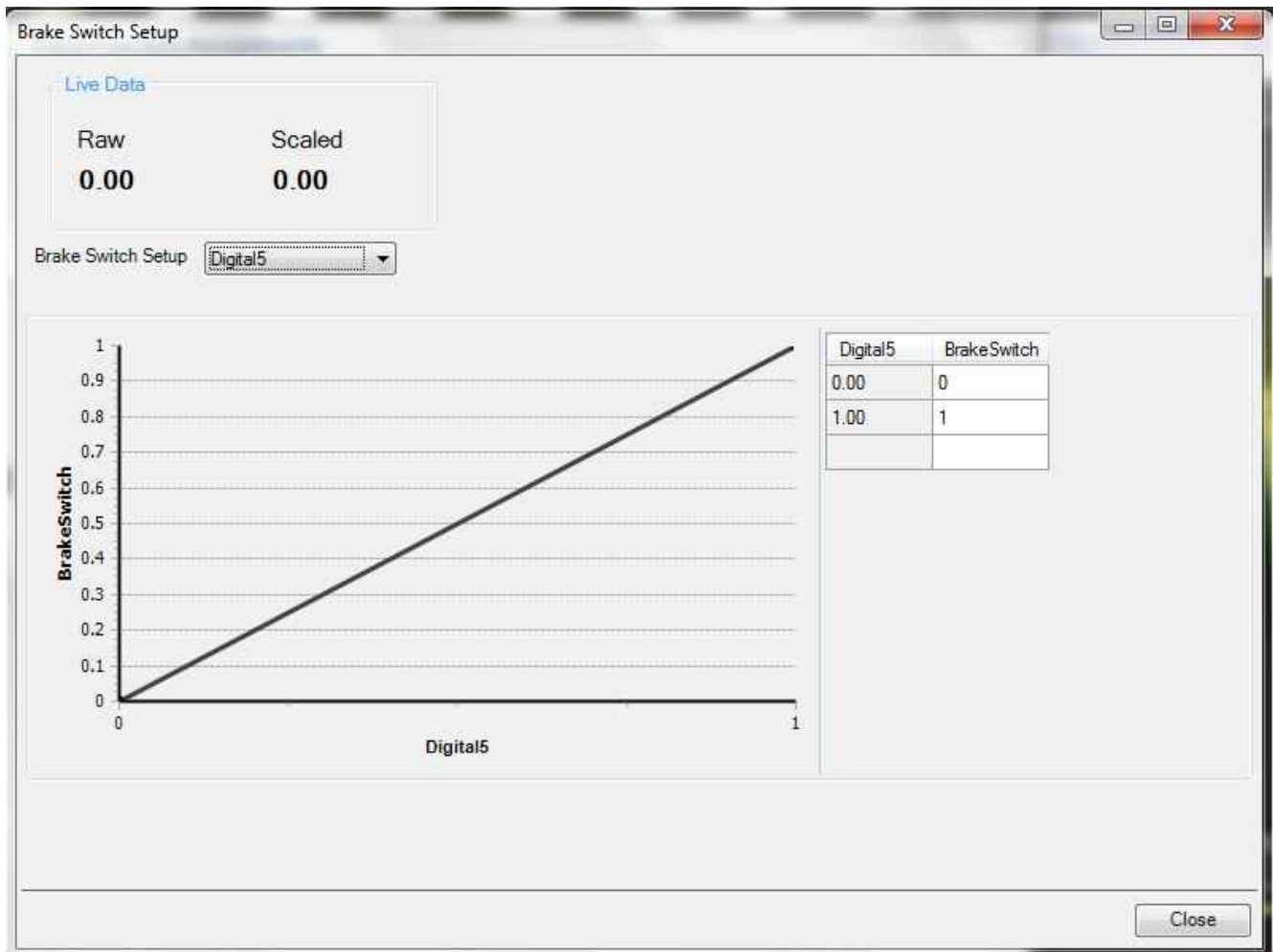

Choose the input channel from the available selections in the drop down list. Use the table to define the logic output. In the example above, the two breakpoints are used to define a function where the input is ON when the digital input pin state is low '0' and OFF when the digital input pin state is high '1'. The logic can be inverted by simply swapping the values in the BrakeSwitch column.

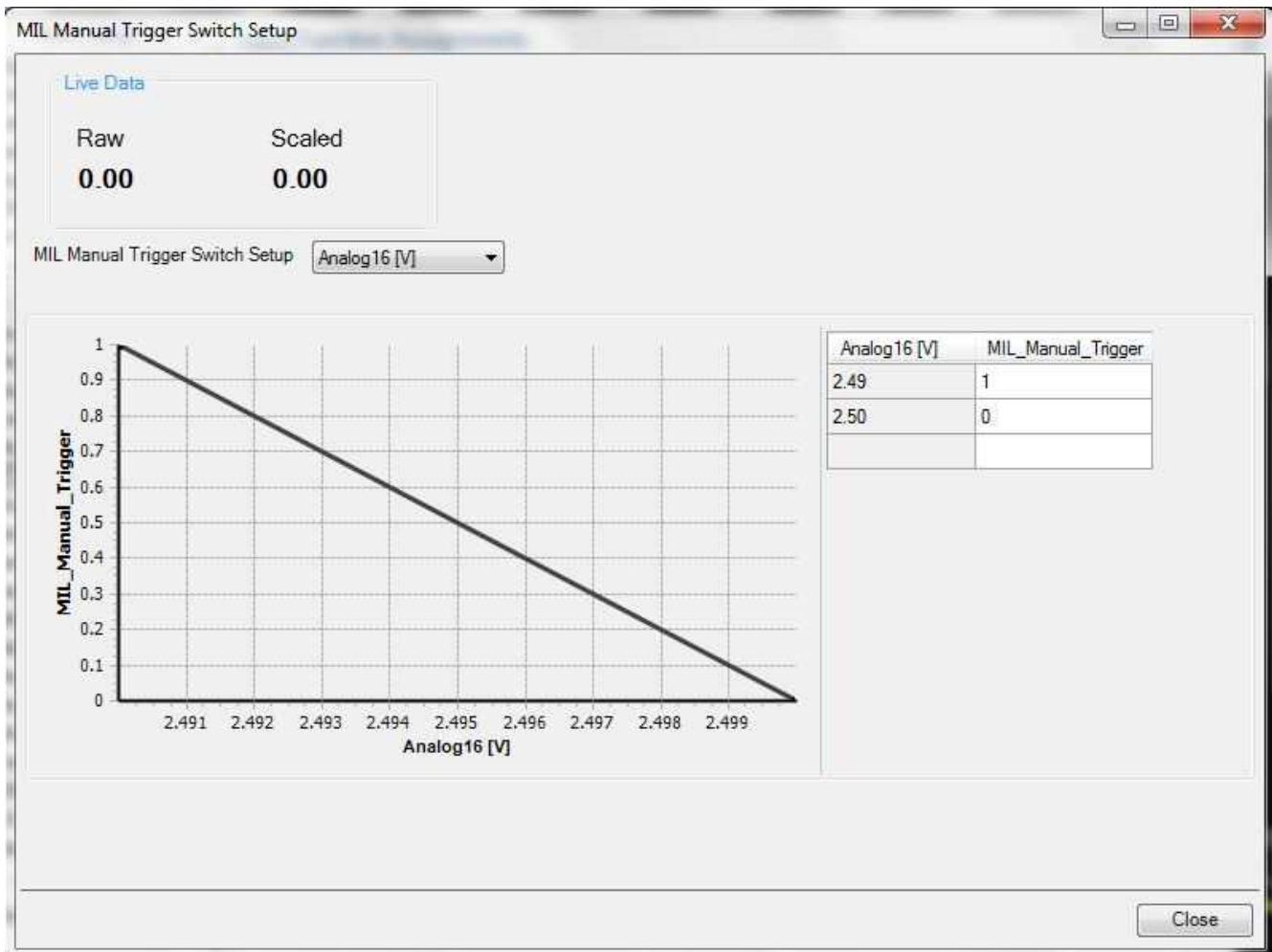

Can be used to trigger the MIL output using an external input. Choose the input channel from the available selections in the drop down list. Use the table to define the logic output. In the example above, the two breakpoints are used to define a function where the input is ON below 2.49 volts and OFF above 2.50 volts.

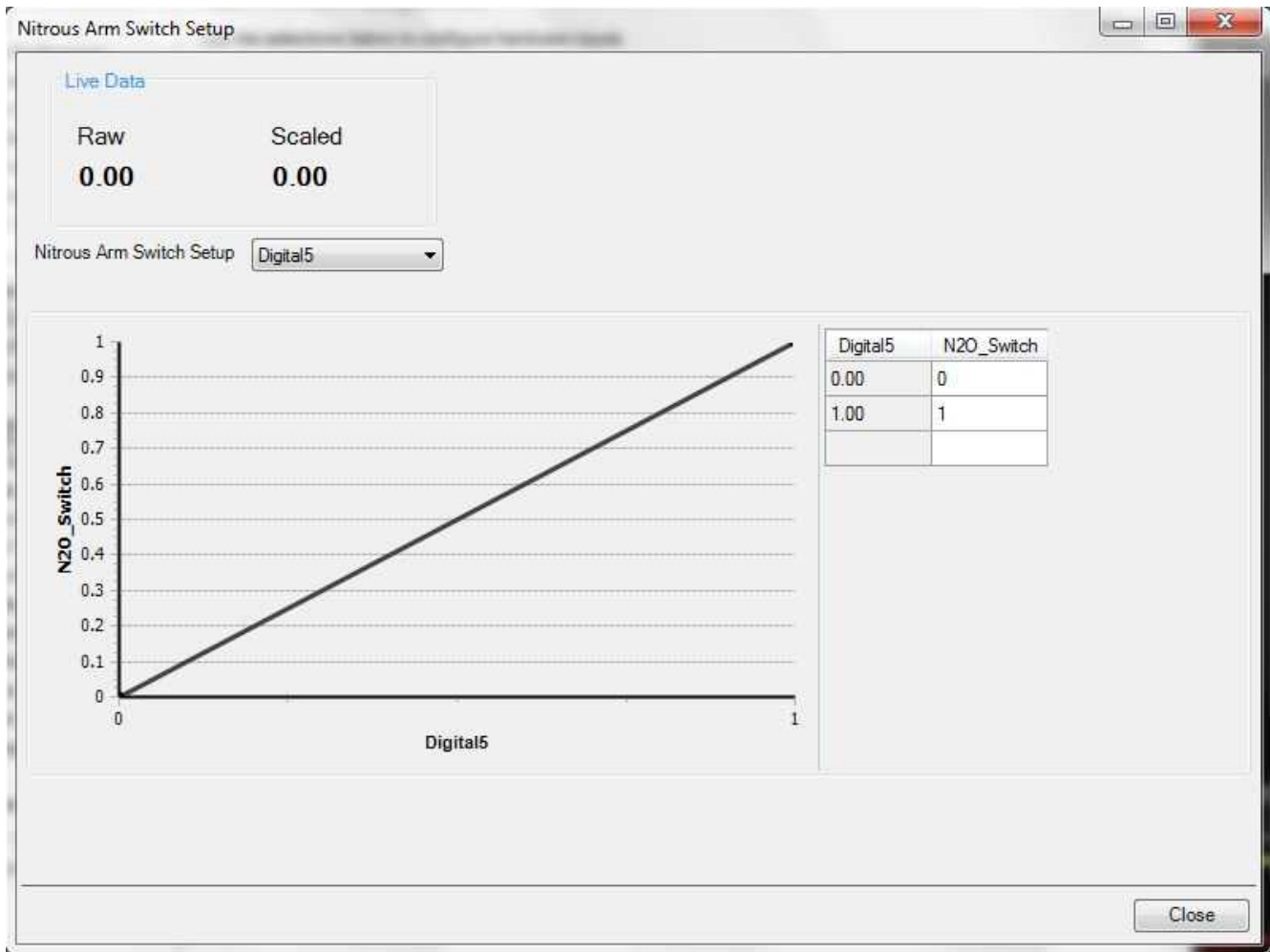

Choose the input channel from the available selections in the drop down list. Use the table to define the logic output. In the example above, the two breakpoints are used to define a function where the input is OFF when the digital input pin state is low '0' and ON when the digital input pin state is high '1'. The logic can be inverted by simply swapping the values in the N2O_Switch column.

Function	Channel	Pin	Raw	Scaled
Flex Content Input Setup	Dig5 [Hz]	C1-26	0.00	0.00
DriveWheelSpeed (Left) Input	DLWheelSensor [Hz]	C1-52	0.00	0.00
DriveWheelSpeed (Right) Input	DRWheelSensor [Hz]	C2-25	0.00	0.00
GroundSpeed (Left) Input	NLWheelSensor [Hz]	C1-49	0.00	0.00
GroundSpeed (Right) Input	NRWheelSensor [Hz]	C2-28	0.00	0.00
Turbo Speed Input Setup	Dig3 [Hz]	C1-24	0.00	0.00
Vehicle Speed Input	VSS_Digital [MPH]		0.00	0.00

All user configurable frequency inputs can be setup from this window.

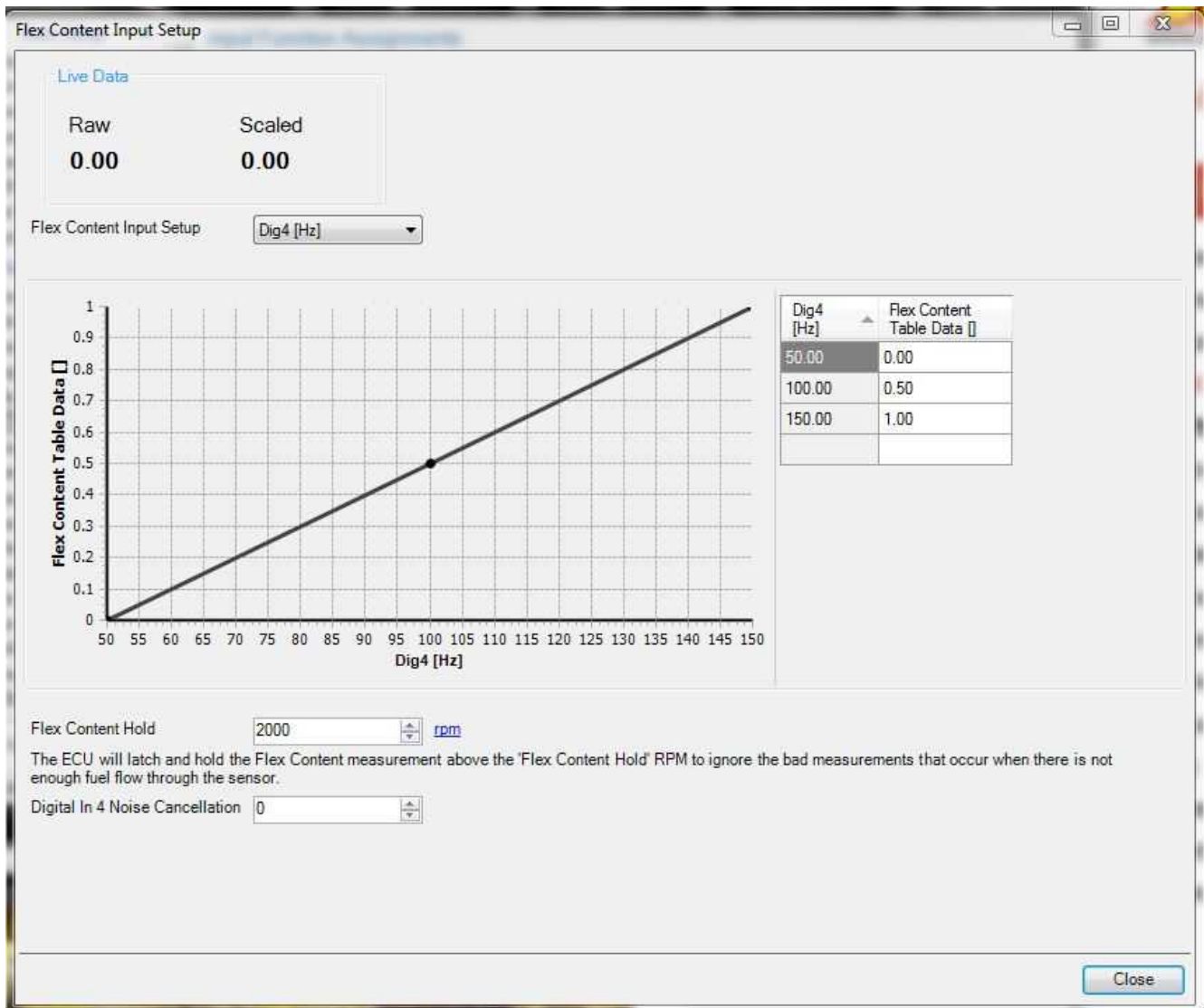

This table is used to convert the raw digital input from a flex fuel sensor to flex fuel content. In the example above, a value of 50 Hz corresponds to 0% flex content. A value of 150 Hz corresponds to 100% flex content.

Flex Content Hold:

This is an engine protection feature. When flex content sensors are installed in the return line, they sometimes do not receive enough flow to measure good data, especially at high load. This of course depends on the fuel system setup. This setting can be used to latch the flex content data above a certain engine speed.

Digital In 4 Noise Cancellation:

Optional noise filter if using the Digital 4 input. Usually not needed. A larger value will filter out more noise. Start with a value of 10.

Select the sensor input to use, then choose the scaling factor for calculating DriveWheelSpeed

Live Data	
Raw	Scaled
0.00	0.00

DriveWheelSpeed (Left) Input

Driven Wheel Speed Calibration Frequency-to-MPH

Driven Wheel Speed Smoothing %

Driven Wheel Speed Calibration:

This is a multiplier which is used to synchronize the actual speed of the vehicle to the Infinity Tuner's Driven Wheel Speed on left side.

Min value = 0, Max value = 10

Note this channel must be set to 1.00 if CAN wheelspeeds are used.

Driven Wheel Speed Smoothing:

Value used to smooth signal.

Min value = 0%, Max value = 99.9%

Select the sensor input to use, then choose the scaling factor for calculating DriveWheelSpeed

Live Data	
Raw	Scaled
0.00	0.00

DriveWheelSpeed (Right) Input

Driven Wheel Speed Calibration Frequency-to-MPH

Driven Wheel Speed Smoothing %

Driven Wheel Speed Calibration:

This is a multiplier which is used to synchronize the actual speed of the vehicle to the Infinity Tuner's Driven Wheel Speed on right side.

Min value = 0, Max value = 10

Note this channel must be set to 1.00 if CAN wheelspeeds are used.

Driven Wheel Speed Smoothing:

Value used to smooth signal.

Min value = 0%, Max value = 99.9%

Select the sensor input to use, then choose the scaling factor for calculating GroundSpeed

Live Data	
Raw	Scaled
0.00	0.00

GroundSpeed (Left) Input

Non-Driven Wheel Speed Calibration Frequency-to-MPH

Ground Speed Smoothing %

Non-Driven Wheel Speed Calibration:

This is a multiplier which is used to synchronize the actual speed of the vehicle to the Infinity Tuner's Non-Driven Wheel Speed on left side.

Min value = 0, Max value = 10

Note this channel must be set to 1.00 if CAN wheelspeeds are used.

Ground Speed Smoothing:

Value used to smooth signal.

Min value = 0%, Max value = 99.9%

Select the sensor input to use, then choose the scaling factor for calculating GroundSpeed

Live Data	
Raw	Scaled
0.00	0.00

GroundSpeed (Right) Input

Non-Driven Wheel Speed Calibration Frequency-to-MPH

Ground Speed Smoothing %

Non-Driven Wheel Speed Calibration:

This is a multiplier which is used to synchronize the actual speed of the vehicle to the Infinity Tuner's Non-Driven Wheel Speed on right side.

Min value = 0, Max value = 10

Note this channel must be set to 1.00 if CAN wheelspeeds are used.

Ground Speed Smoothing:

Value used to smooth signal.

Min value = 0%, Max value = 99.9%

Use the Turbo Speed Calibration to set the scaling factor for your turbocharger speed frequency input. Turbo Speed [RPM] is calculated by multiplying the raw TurboSpeed [Hz] frequency by the factor 'Turbo Speed Multiplier'. For example, if the sensor output is 2 pulses per revolution, set the multiplier to $(60 / 2) = 30$. If the sensor output is 4 pulses per revolution, set the multiplier to $(60/4) = 15$.

[Live Data](#)

Raw	Scaled
0.00	0.00

Turbo Speed Input Setup

Turbo Speed Multiplier

Turbo Speed Input Setup:

Digital input selector for Turbo Speed.

Turbo Speed Multiplier:

This is a multiplier which is used to synchronize the actual speed of the vehicle to the Infinity Tuner's Vehicle Speed.

Min value = 0, Max value = 50

By default, the signal VSS_Digital will be used for calculating Vehicle Speed. GroundSpeed and DriveWheelSpeed are calculated from the individual wheel speed sensors, and can be used for the VehicleSpeed input if desired.

Live Data

Raw	Scaled
0.00	0.00

Vehicle Speed Input VSS_Digital [MPH]

▼Hide VSS_Digital Input Setup

Select which pin to use for the VSS_Digital frequency input.

VSS Digital Input Dig4 [Hz]

Vehicle Speed Calibration is a simple multiplier used to calculate the Vehicle Speed channel based on the frequency input. For instance, if the calculated Vehicle Speed value is too high, decrease Vehicle Speed Calibration.

Vehicle Speed Calibration 1.000 Frequency-to-MPH

Vehicle Speed Smoothing 0.0 %

Vehicle Speed Input:

Select vehicle speed input from VSS_Digital, Ground Speed, or Drive Wheel Speed.

VSS Digital Input:

Select digital input method for Vehicle Speed sensor, default is Digital 4 (C1-25 on Infinity 8/10 and C1-29 on Infinity 6/8h).

Vehicle Speed Calibration:

This is a multiplier which is used to synchronize the actual speed of the vehicle to the Infinity Tuner's Vehicle Speed.

Min value = 0, Max value = 10

Vehicle Speed Smoothing:

Value used to smooth signal.

Min value = 0%, Max value = 99.9%

Function	Channel	Pin	Raw	Scaled	
Airbox Temp Sensor Input	Analog11 [V]	C1-74	none	0.00	
ChargeOutTemp Sensor Input	Analog10 [V]	C1-75	none	0.00	
Oil Temp Sensor Input	OT_sens [ohms]	C1-40	none	0.00	

All user configurable analog temperature inputs can be setup from this window.

This wizard sets the Oil Temp Failsafe to 80 C and enters the correct Oil Temp Sensor Cal Table, Oil Temp Fail Max Option, and Oil Temp Fail Min Option for the specific OT sensor currently selected.

Live Data

Raw	Scaled
0.00	0.00

Oil Temp Sensor Input

Sensor Selection:

No wizard is selected or matched. Click the Browse button to select one.

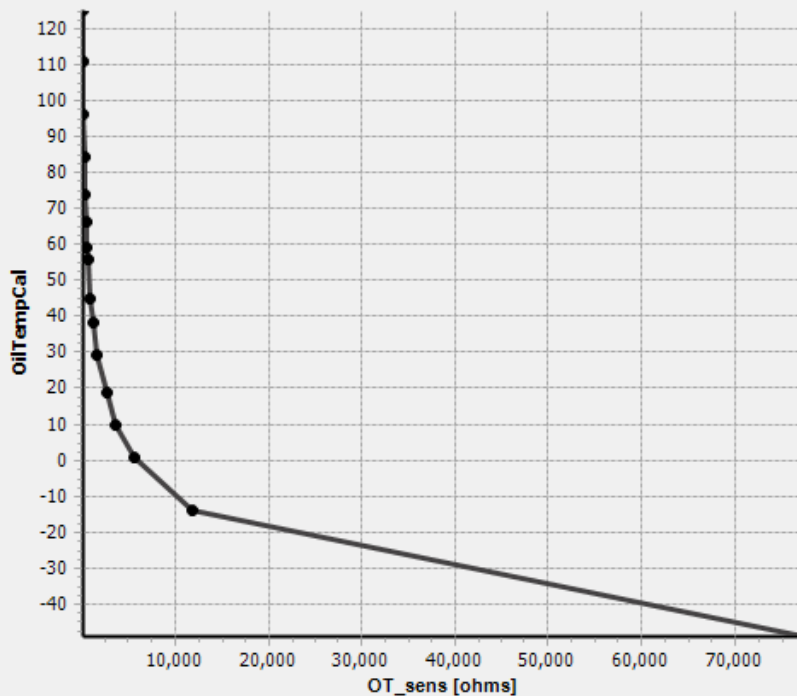

OT_sens [ohms]	OilTempCal
100.00	125
119.00	111
170.00	96
235.00	84
308.00	74
390.00	66
482.00	59
562.00	56
878.00	45
1175.00	38
1633.00	29
2700.00	19
3657.00	10
5620.00	1
11750.00	-14
77600.00	-49

Oil Temp Fail Min °C

Oil Temp Fail Max °C

Oil Temp Failsafe On

Oil Temp Failsafe °C

Oil Temp Smoothing %

Oil Temp Sensor Input:

Drop down menu of selectable inputs.

Sensor Selection:

Selecting this box will present a menu with multiple pre configured oil temperature sensors to choose from.

Oil Temp Fail Min:

This Oil Temp Fail Min should be set to a value that is just above the oil temperature value when the sensor is unplugged.

Oil Temp Fail Max must be > Oil Temp Fail Min.

User entries that do not meet this criteria are not allowed.

Min value = -50, Max value = 300

Oil Temp Fail Max:

This Oil Temp Fail Max should be set to a value that is just below the air temperature value when the sensor is shorted. This will trigger the failsafe feature. This can be tested and entered by carefully inserting each leg of a paper clip into each terminal of the wiring harness.

Oil Temp Fail Max must be > Oil Temp Fail Min.

User entries that do not meet this criteria are not allowed.

Min value = -50, Max value = 300

Oil Temp Failsafe On:

When clicking, the failsafe feature is enabled. This is typically used when the sensor is mistakenly unplugged or has failed.

Oil Temp Failsafe:

The value entered here will be displayed and used for the air temperature corrections when the sensor has failed or is simply unplugged. Min value = -50, Max value = 300

Oil Temp Smoothing:

Value used to smooth signal. Min value = 0, Max value = 98

Function	Channel	Pin	Raw	Scaled
IgnitionBlend Table x-axis	FlexContent [%]		0.00	0.00
LambdaFlexBlend Table x-axis	FlexContent [%]		0.00	0.00
VE_Blend Table x-axis	FlexContent [%]		0.00	0.00

Multi-map features that include blending tables can be configured in this section.

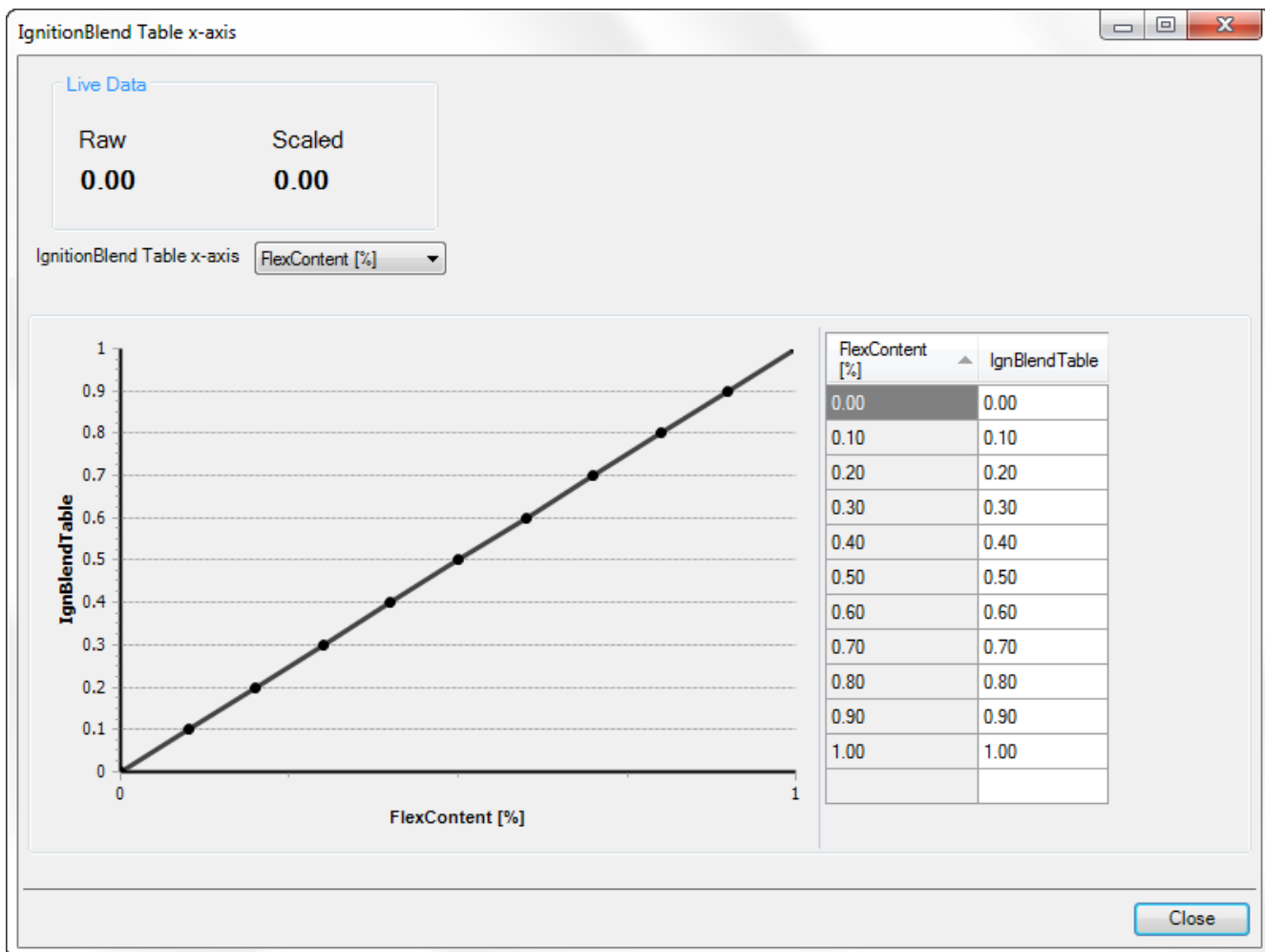

Select the axis input then configure the table values as needed. See [Multi-Map Tuning](#) ²⁴¹ for more detail.

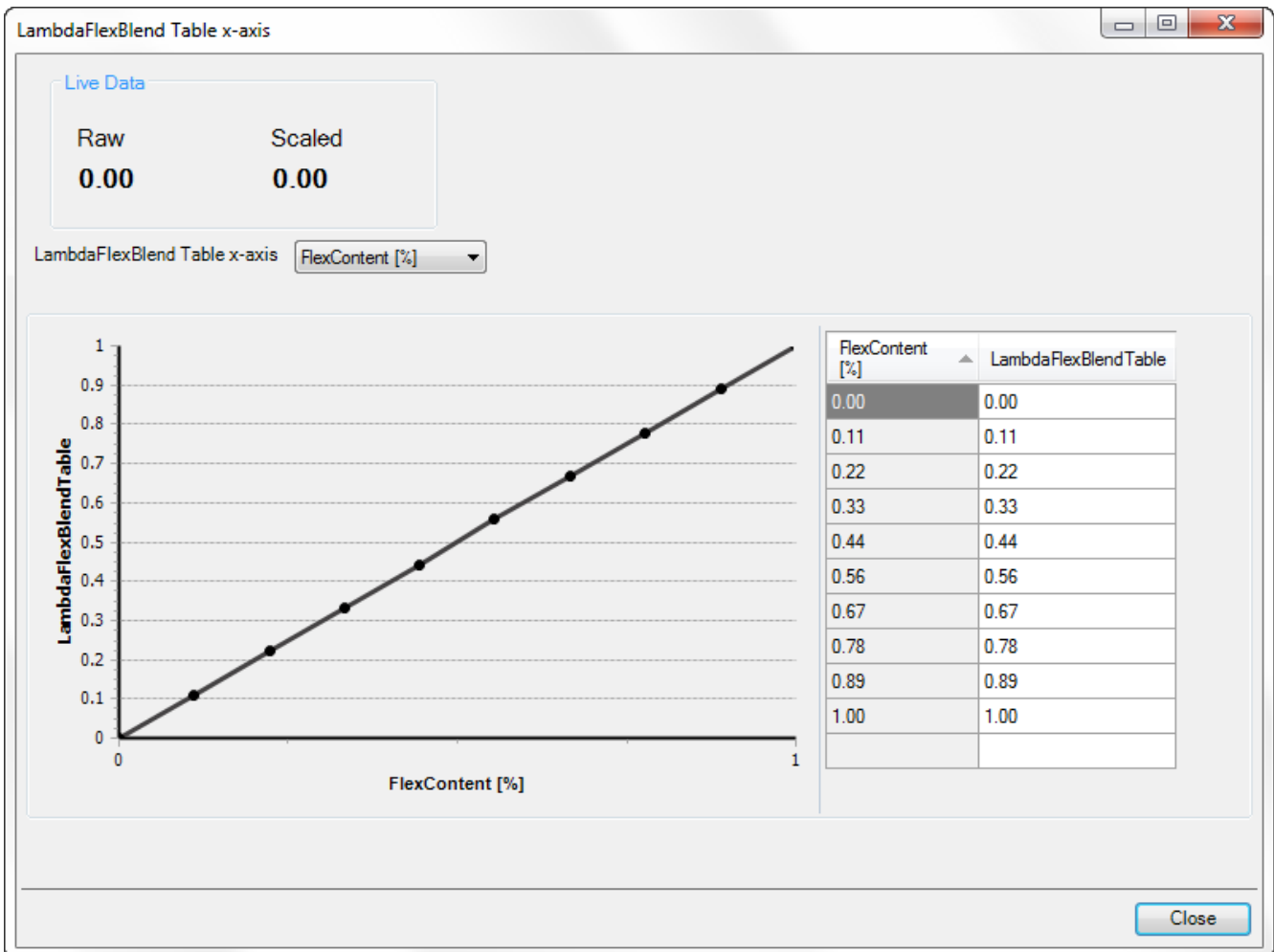

Select the axis input then configure the table values as needed. See [Multi-Map Tuning](#) ²⁴¹ for more detail.

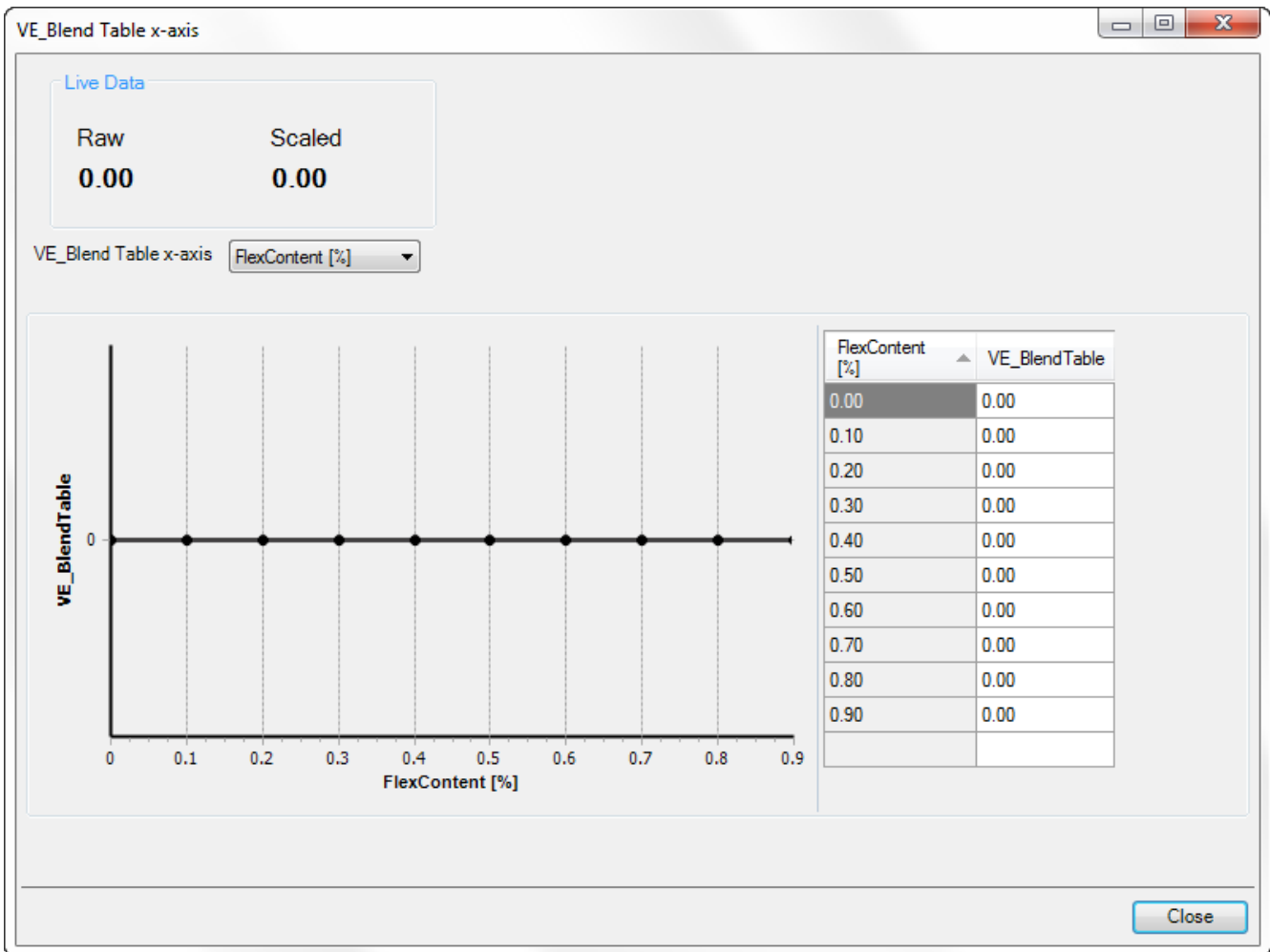

Select the axis input then configure the table values as needed. See [Multi-Map Tuning](#)²⁴¹ for more detail.

Knock Setup

The setup wizard screen shot below describes each available setting for knock response. The text descriptions included in the setup dialog describe each tuning option in detail.

AEM Infinity-6

Basic Setup

Engine

Tuning Preferences

Cam/Crank

Injector Setup

Basic Sensors

DBW Tuning

Set Throttle Range

Ignition Sync

Advanced Setup

Accel and Decel Fuel

Boost Control

Engine Protection

Fuel Trims

Idle

Input Function Assignments

Knock Setup

Lambda Control

Launch Antilag

Launch Timer

Nitrous N2O

Main Rev Limiter

Rev Limit 2 Step

Rev Limit 3 Step

Shift Cut

Traction Control

USB Logging

VVC

Diagnostics

Outputs

Knock Setup

The Infinity ECU measures knock sensor activity during a specific window for each cylinder; this allows the ECU to detect individual cylinder knock levels using only one or two sensors. Because some sensors may be located nearer or further from the cylinder, Knock Noise Floor tables are available for each cylinder. When sensor activity exceeds the Noise Floor, ignition timing can be retarded for that cylinder.

Knock Feedback Enabled

▶ Show Advanced Options: Sensor Assignment and Windowing Angle

▶ Show Advanced Options: Noise Filter Settings

Knock Feedback Minimum Throttle Position %

The ECU calculates the value 'KnockCylX' for each cylinder, which represents the amount of knock activity above that cylinder's KnockNoiseFloorX table. The ignition retard for each cylinder is calculated by multiplying the Knock Feedback Ignition Gain by the KnockCylX value. For instance, when KnockCylX is 0.2 and the feedback ignition gain is set to 5.0, the ignition retard KnockFB_CylX will increase by $(0.2 * 5.0) = 1.0$ degrees. If the sensor continues to indicate knock, the ignition trim will continue to increase until it hits the Maximum Ignition Retard Limit.

Knock Feedback Ignition Gain

Knock Feedback Maximum Ignition Retard limit

When the sensor is not indicating knock, the ECU will decrease the knock ignition trim by this amount every ~2ms. Smaller numbers for Knock Feedback Ignition Decay Rate will result in a longer time for the ignition trim to decay back to zero, and larger numbers will remove the knock feedback more quickly.

Knock Feedback Ignition Decay Rate

When Knock Global Feedback is enabled, the largest calculated knock feedback ignition trim will be applied to all cylinders, even if only one cylinder is detected to be above the KnockNoiseFloor threshold.

Knock Global Feedback

The ECU will calculate 'LambdaTrim_Knock' by multiplying the largest KnockCylX value by the Knock Feedback Lambda Gain. This will modify the ECU's target Lambda value, for instance if the original target was 0.82 lambda and LambdaTrim_Knock is 0.01, the new lambda target will be 0.81 lambda.

Knock Feedback Lambda Gain

AEM Infinity-6

Basic Setup

Engine

Tuning Preferences

Cam/Crank

Injector Setup

Basic Sensors

DBW Tuning

Set Throttle Range

Ignition Sync

Advanced Setup

Accel and Decel Fuel

Boost Control

Engine Protection

Fuel Trims

Idle

Input Function Assignments

Knock Setup

Lambda Control

Launch Antilag

Launch Timer

Nitrous N2O

Main Rev Limiter

Rev Limit 2 Step

Rev Limit 3 Step

Shift Cut

Traction Control

USB Logging

VVC

Diagnostics

Outputs

Hide Advanced Options: Sensor Assignment and Windowing Angle

Cylinder	Sensor	Knock Window Start (degBTDC)	Knock Window Width (deg)
Cylinder 1	Knock Sensor #1	10	60
Cylinder 2	Knock Sensor #1	10	60
Cylinder 3	Knock Sensor #2	10	60
Cylinder 4	Knock Sensor #2	10	60

Hide Advanced Options: Noise Filter Settings

The raw voltage from the knock sensor is sent through a software-adjustable filter chip before being measured by the ECU. It is assumed that frequencies above or below the Center Frequency represent mostly noise, and should be filtered out. The Gain channel should be adjusted so that the Knock_X_raw channels are low when the engine is not knocking but still below their maximum value of 0.99 in response to audible pinging or slight detonation observed in the power trace of a dyno plot. The Integrator/Smoothing time can be adjusted to dampen the response to background noise, but be careful not to increase this to the point that the filter is too slow in responding to actual knock activity.

Bandpass Center Frequency: 6.94 kHz

Amplifier Gain: 2.000

Integrator (smoothing) Time: 300 us

Knock Feedback Minimum Throttle Position: 30 %

The ECU calculates the value 'KnockCylX' for each cylinder, which represents the amount of knock activity above that cylinder's KnockNoiseFloorX table. The ignition retard for each cylinder is calculated by multiplying the Knock Feedback Ignition Gain by the KnockCylX value. For instance, when KnockCylX is 0.2 and the feedback ignition gain is set to 5.0, the ignition retard KnockFB_CylX will increase by $(0.2 * 5.0) = 1.0$ degrees. If the sensor continues to indicate knock, the ignition trim will continue to increase until it hits the Maximum Ignition Retard Limit.

Knock Feedback Ignition Gain: 5.000

Knock Feedback Maximum Ignition Retard Limit: 0

Advanced Options: Noise Filter Settings

Bandpass Center Frequency

Units: kHz

Description: The raw voltage from the knock sensor is sent through a software-adjustable filter chip before being measure by the ECU. It is assumed that the frequencies above or below this Center Frequency represents mostly noise and should be filtered out.

Amplifier Gain

Units: Scalar

Description: This is a tuner preference and is used to scale the knock sensor signal input(s). Depending on the knock sensor type, some output larger signals. This gain channel should be adjusted so that the Knock_X_raw channels are low when the engine is knocking but still below their maximum value in response to audible pinging or slight detonation observed in the power trace of a dyno plot.

Integrator (smoothing) Time**Units:** μS **Description:** This can be adjusted to dampen the response to background noise, but be careful not to increase this time to a point that the filter is too slow in responding to actual knock activity.**Sensor Assignment and Window Angle**

The table shown below assigns a knock sensor and a window range to each specific cylinder.

▼ Hide Advanced Options: Sensor Assignment and Windowing Angle

Cylinder	Sensor	Knock Window Start (degBTDC)	Knock Window Width (degBTDC)
Cylinder 1	Knock Sensor #1	0	50
Cylinder 2	Knock Sensor #1	0	50
Cylinder 3	Knock Sensor #1	0	50
Cylinder 4	Knock Sensor #2	0	50
Cylinder 5	Knock Sensor #2	0	50
Cylinder 6	Knock Sensor #2	0	50

Note that new features have been added. The response to knock detection is different in version 95 or later. Tuners should verify knock response on the vehicle. Contact AEM Tech Support for help if needed.

The Infinity has 2 inputs for knock sensors. These can be passive, where data is displayed and/or recorded or the feedback knock control can be enabled, letting the Infinity take action to counter the knock. The Infinity ECU measures knock sensor activity during a specific window for each cylinder; this allows the ECU to detect individual cylinder knock levels using only one or two sensors. Because some sensors may be located nearer or further from the cylinder. Knock Noise Floor tables are available for each cylinder. When sensor activity exceeds the Noise Floor, ignition timing can be retarded for that cylinder.

KnockNoiseFloor1 Table**Units:** Voltage vs Engine Speed

Description: The **KnockNoiseFloor1 Table** sets an RPM dependant threshold to filter out background noise from cylinder 1. Setting up this table is key to the success of this function. Whenever the knock sensor voltage input exceeds this table's voltage value, it is considered to be detonation. The difference between the detonation signal and this threshold value determines the severity of the knock.

KnockNoiseFloor1									
0.03	0.04	0.04	0.05	0.05	0.06	0.06	0.07	0.07	0.08
1000	2000	3000	4000	5000	6000	7000	8000	9000	10000
EngineSpeed [RPM]									

KnockNoiseFloor2 Table**Units:** Voltage vs Engine Speed

Description: The **KnockNoiseFloor2 Table** sets an RPM dependant threshold to filter out background noise from cylinder 2. Setting up this table is key to the success of this function. Whenever the knock sensor voltage input exceeds this table's voltage value, it is considered to be detonation. The difference between the detonation signal and this threshold value determines the severity of the knock.

KnockNoiseFloor2									
0.03	0.04	0.04	0.05	0.05	0.06	0.06	0.07	0.07	0.08
1000	2000	3000	4000	5000	6000	7000	8000	9000	10000
EngineSpeed [RPM]									

KnockNoiseFloor3 Table

Units: Voltage vs Engine Speed

Description: The **KnockNoiseFloor3 Table** sets an RPM dependant threshold to filter out background noise from cylinder 3. Setting up this table is key to the success of this function. Whenever the knock sensor voltage input exceeds this table's voltage value, it is considered to be detonation. The difference between the detonation signal and this threshold value determines the severity of the knock.

KnockNoiseFloor3									
0.03	0.04	0.04	0.05	0.05	0.06	0.06	0.07	0.07	0.08
1000	2000	3000	4000	5000	6000	7000	8000	9000	10000
EngineSpeed [RPM]									

KnockNoiseFloor4 Table

Units: Voltage vs Engine Speed

Description: The **KnockNoiseFloor4 Table** sets an RPM dependant threshold to filter out background noise from cylinder 4. Setting up this table is key to the success of this function. Whenever the knock sensor voltage input exceeds this table's voltage value, it is considered to be detonation. The difference between the detonation signal and this threshold value determines the severity of the knock.

KnockNoiseFloor4									
0.03	0.04	0.04	0.05	0.05	0.06	0.06	0.07	0.07	0.08
1000	2000	3000	4000	5000	6000	7000	8000	9000	10000
EngineSpeed [RPM]									

KnockNoiseFloor5 Table

Units: Voltage vs Engine Speed

Description: The **KnockNoiseFloor5 Table** sets an RPM dependant threshold to filter out background noise from cylinder 5. Setting up this table is key to the success of this function. Whenever the knock sensor voltage input exceeds this table's voltage value, it is considered to be detonation. The difference between the detonation signal and this threshold value determines the severity of the knock.

KnockNoiseFloor5									
0.03	0.04	0.04	0.05	0.05	0.06	0.06	0.07	0.07	0.08
1000	2000	3000	4000	5000	6000	7000	8000	9000	10000
EngineSpeed [RPM]									

KnockNoiseFloor6 Table

Units: Voltage vs Engine Speed

Description: The **KnockNoiseFloor6 Table** sets an RPM dependant threshold to filter out background noise from cylinder 6. Setting up this table is key to the success of this function. Whenever the knock sensor voltage input exceeds this table's voltage value, it is considered to be detonation. The difference between the detonation signal and this threshold value determines the severity of the knock.

KnockNoiseFloor6									
0.03	0.04	0.04	0.05	0.05	0.06	0.06	0.07	0.07	0.08
1000	2000	3000	4000	5000	6000	7000	8000	9000	10000
EngineSpeed [RPM]									

Tuning with Knock Sensor(s)

To set up the knock sensor control, first identify which cylinders correspond to each knock sensor input. It must be understood that knock sensors can pick up a lot of noise depending on the type of sensor and engine setup. The only way the Infinity can determine when actual detonation occurs is by calibrating the knock sensor being used. The following is an ideal way to set up the **KnockNoiseFloor** tables. For this test, use high octane quality-grade fuel.

- Get the vehicle on a dynamometer to perform a few 4th and 5th gear power pull sweeps.
- Temporarily add 10–15% more fuel in the **VE Table**.
- Retard 2–4 degrees of ignition timing in the **BaseIgnMap** calibration file.
- Start the logger, **Log | Start Recording**.
- At a very low engine speed in 4th gear, such as 1500RPM, depress the throttle completely to the floor (WOT).
- Monitor **Lambda1** (or 2) and confirm a safe rich mixture.
- If turbocharged, monitor **MAP** closely as the retarded ignition timing will naturally increase boost pressure.
- If wired and plumbed in, monitor the EGT sensor reading as the retarded ignition timing will increase exhaust temperatures.
- Stop the logger, **Log | Stop Recording**.
- Perform the same test in 5th gear.
- For every engine speed breakpoint in the **KnockNoiseFloor** tables, note the **KnockSense** channel's data. This is mechanical noise in the engine that is near the same frequency as knock but is not real knock.
- Draw an imaginary line about 10–25% above these values for every **KnockNoiseFloor** table breakpoint. It should start off very low and increase with RPM.

Everything below these points will be considered normal engine noise. Everything above these data points will be considered true detonation. When actual voltage values breach these points, knock control will be enabled. So now we need to define what exactly the Infinity should do when it sees knock.

Lambda Control

Lambda Enable

Lambda Feedback Enable	<input type="checkbox"/>
Lambda Feedback Rich Limit	20.0 %
Lambda Feedback Lean Limit	-20.0 %

Lambda Feedback Enable:

Enable/disables the lambda feedback feature.

Lambda Feedback Rich Limit:

Maximum allowable feedback value when adding fuel to enrich the fuel mixture. Lambda feedback will be clamped to this maximum value, even if the measured air/fuel ratio is leaner than the target.

Min value = 0%, Max value = 50%

Lambda Feedback Lean Limit:

Maximum allowable feedback value when removing fuel to lean the fuel mixture. Lambda feedback will be clamped to this maximum value, even if the measured air/fuel ratio is richer than the target.

Min value = -50%, Max value = 0%

Lambda Activation Criteria

Lambda Feedback Min Speed	800 rpm
Lambda Feedback Max Speed	10000 rpm
Lambda Feedback Min Load	0.72519 psi
Lambda Feedback Max Load	101.52640 psi

Lambda Activation Criteria:

Lambda Feedback Min Speed [RPM]:

Lambda feedback is disabled below this RPM. This value should be increased for setups with aggressive camshafts or very short exhaust piping after the sensor, which can result in 'false lean' measurements when the O2 sensor measures outside air in addition to exhaust gas at low engine speeds.

Min value = 0, Max value = 20,000

Lambda Feedback Max Speed [RPM]:

Lambda feedback is disabled above this RPM. Used to force open loop operation above a certain engine speed.

Min value = 0, Max value = 20,000

Lambda Feedback Min Load [kPa]:

Lambda feedback is disabled below this manifold pressure. Sometimes useful for setups with aggressive camshaft or very short exhaust piping where exhaust reversion can cause 'false lean' measurements when cruising at very low manifold pressures. If using decel fuel cut, it may be useful to set this value to the same value as the **Decel Cut Below MAP** value.

Min value = 0, Max value = 700

Lambda Feedback Max Load [kPa]:

Lambda feedback is disabled above this manifold pressure. Some tuners prefer to run open loop without lambda feedback above a certain MAP pressure.

Min value = 0, Max value = 700

Advanced Setup:

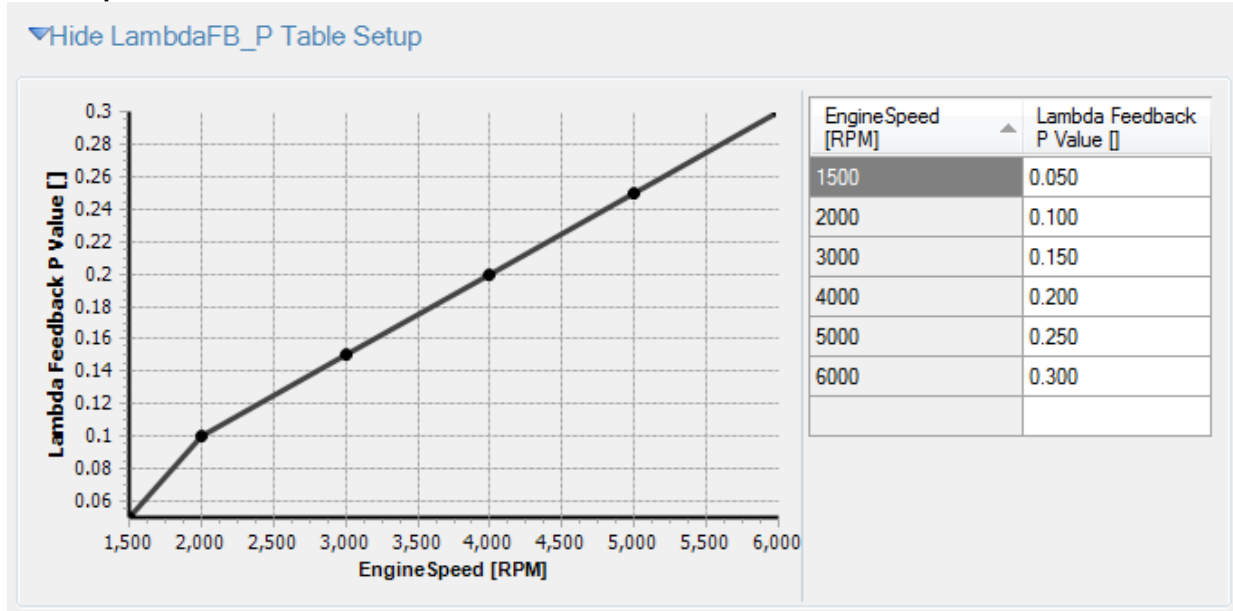

Lambda Control Proportional Gain:

Proportional control is a pure gain adjustment acting on the magnitude of the target error to provide the system response. The advantage of a proportional-only control is it can respond quickly to large errors; when the error is large the proportional response will be large. The disadvantage of proportional gain for idle control is the proportional response will decrease to zero as the measured Lambda value gets closer to the target lambda, and excessive Proportional gain can sometimes result in 'hunting' lambda values near the target. Since most tuners want to hit their lambda target and stay there, it is recommended to rely more heavily on the Integral feedback gain and leave Proportional gain at lower values. If the system responds too slowly to quick disturbances or large errors, increase this value slightly.

Min value = 0.000, Max value = 0.500

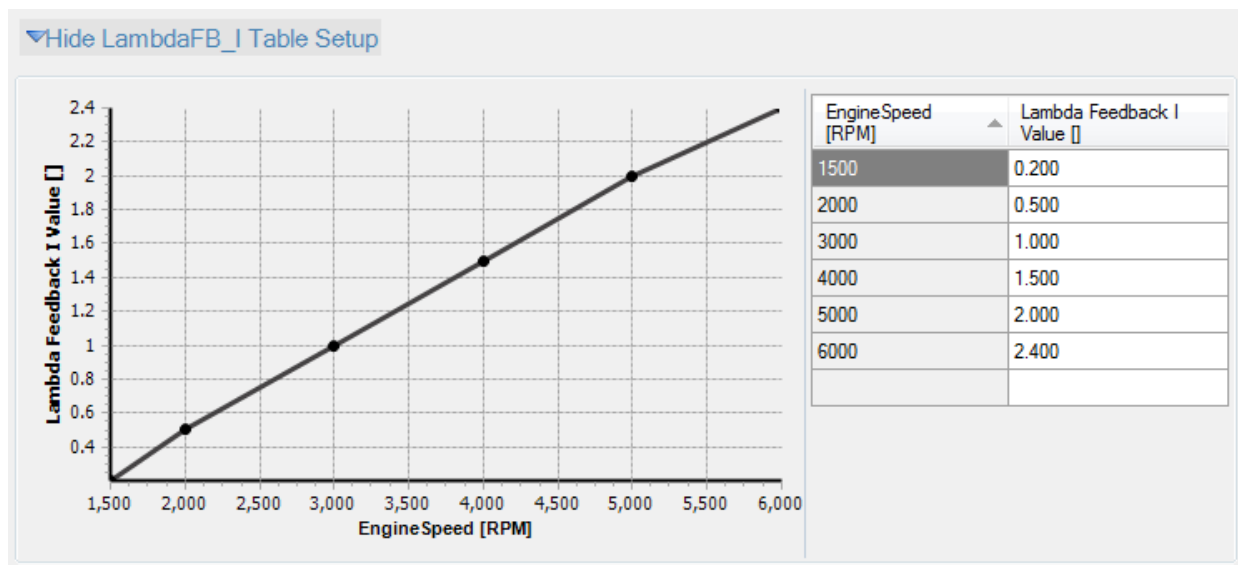

Lambda Control Integral Gain:

Note that the integral gain is adjusted in the table LambdaFB_I, which adjusts the integral gain based on Engine Speed. It is recommended to adjust the LambdaFB_I table before adjusting the Proportional or Derivative values. More details in the [Lambda Control](#)^[126] section.

▼ Hide Advanced Setup

Lambda Feedback Proportional and Feedback Integral Gain must be adjusted using the 1D tables 'LambdaFB_P' and 'LambdaFB_I'. The gain can be adjusted per RPM

Lambda Feedback Derivative Gain

Lambda Feedback After-Start Delay ms

Lambda Feedback Max WallWetting

Lambda Feedback ReArm Time ms

LambdaTarget Table Y-Axis

The Lambda1PID and Lambda2PID feedback calculations will be assigned to use the onboard UEGO controller signals Lambda1 and Lambda2 by default. It is also possible to reassign the feedback calculations to use the external signals Lambda3 or Lambda4.

Lambda1PID Feedback Input Selection

Lambda2PID Feedback Input Selection

Lambda Control Derivative Gain:

The derivative term adjusts the feedback based on how quickly the target error changes. Derivative control is used to reduce the amount of overshoot that may occur due to the Proportional gain's response to large errors. For instance, if the Lambda1 value is below the target but increasing toward the target quickly, the Derivative term will decrease feedback to avoid a possible overshoot. In this example, larger derivative gains would result in larger negative feedback. When the lambda value increases more slowly, the Derivative contribution will decrease. Note: For most setups, it is recommended to leave the Derivative gain set to zero.

Min value = 0.000, Max value = 0.100

Lambda Feedback After-Start Delay:

Lambda feedback will be disabled for this many seconds after the engine is started. Adjust this value to avoid performing feedback while the exhaust sensor may still contain fresh air. If the engine begins running poorly when feedback turns on, try increasing this value.

Min value = 0 seconds, Max value = 25 seconds

Lambda Feedback ReArm Time:

Lambda feedback will be disabled for this amount of time after exiting from various transient conditions. These include wall wetting fuel enrichment and any engine protection or torque control RPM cut like traction control, 2 step, 3 step, etc.

Lambda Feedback Max WallWetting:

Lambda feedback can be disabled for 750ms after a significant amount of WallWetting has been added for acceleration fuel enrichment. Adjust this value to set the maximum amount of WallWetting that should be allowed without disabling Lambda Feedback.

Min value = 2, Max value = 30

LambdaTarget Table Y-Axis:

The y-axis of the LambdaTarget table can be reassigned from the default setting of MAP to use Throttle.

This may be useful for naturally aspirated engines with very aggressive camshafts, or other setups that do not pull a significant amount of vacuum when the throttle is closed.

Launch Antilag

Turbo lag is defined as the time delay before the turbocharger has produced boost pressure. Anti-lag is when a turbocharger is subjected to a very late burn causing the exhaust to expand in the turbine housing. This energy is concentrated at the turbocharger causing a very quick turbo spool up. Since turbochargers are designed and sized to operate at specific rpm ranges and air flow conditions, some turbo lag is inherent in the system. To fully understand turbo lag, you must first understand the operation principles behind what causes a turbo to make boost.

Boost is not made by RPM alone. There is a big difference in the airflow through an engine at 6,000 rpm in neutral, 6,000 rpm in first gear at part throttle, and 6,000 rpm in high gear at full throttle. Turbochargers are even more effected by these airflow differences and especially load differences than most other devices. This is why you may be able to see a small amount of boost with a positive displacement supercharger at WOT in neutral, but you may not see any boost at WOT in neutral with a turbocharger.

A given turbocharged vehicle may produce full boost in first gear by 3,500 rpm. This same vehicle may produce full boost in 4th gear by 2,300 rpm. When pulling a heavy trailer, it may produce full boost by 1,800 rpm even in 1st gear. These conditions are more specific to manual transmission vehicles as the boost has to build in each gear after the throttle is closed during the shift. Automatic transmission vehicles operate differently as they can be "loaded" by stalling up the converter and placing enough load to build boost before the vehicle even moves. Also, with an automatic transmission, the throttle is not shut during shifts which causes the boost to "pop up" because the turbo is supplying enough air flow to feed the boosted engine at high rpms and suddenly the rpms are drastically cut down by the shift as well as increased load has been placed on the system at the same time. This can cause an engine that is accelerating in 1st gear with low boost to instantly go to full boost upon shifting into 2nd gear.

Tuning Anti-Lag

The basic idea is to fire the ignition after TDC to cause afterburn in the exhaust to spool the turbocharger to a desired boost level for launching the vehicle. There are a couple of things to consider to obtain the desired results.

- Engine Speed: The amount of engine speed is directly related to how much boost can be made under

anti-lag conditions. A higher engine speed will equate to a higher boost level as well as a faster boost response. If you are unable to make the desired boost pressure for launching, no matter how much ignition retard is used, then more than likely you need to increase the engine speed limiter.

- Ignition Retard: The more the ignition is retarded, the more afterburn and heat will be put into the exhaust. Start at a conservative 5 degrees ATDC, and add more ignition retard until the desired time and boost is reached. Typical numbers are 15-20 degrees ATDC of ignition retard.
- Engine Load: If the boost control is set at "x" pressure, then no more "x" pressure can be obtained when launching. The Infinity Tuner can allow a lower or higher launch boost than the operating boost setting.
- Additional Fuel: Added fuel will also aid in the anti-lag process by insuring the fuel mixture will be there throughout the engine cycle. A typical increase is 5-10%.

AEM Infinity-6

Basic Setup

Engine

Tuning Preferences

Cam/Crank

Injector Setup

Basic Sensors

DBW Tuning

Set Throttle Range

Ignition Sync

Advanced Setup

Accel and Decel Fuel

Advanced Trims

Boost Control

Engine Protection

Idle

Input Function Assignments

Knock Setup

Lambda Control

Launch Antilag

Launch Timer

Nitrous N2O

Main Rev Limiter

Rev Limit 2 Step

Rev Limit 3 Step

Shift Cut

Traction Control

USB Logging

WC

Diagnostics

Outputs

Output Function Assignment

Coils / Injectors

Launch Antilag

For turbocharged vehicles, it is possible to retard ignition timing in order to increase boost at the starting line. The ignition trim value from this table is combined with all other ignition trims.

WARNING: Antilag will increase wear on the engine and turbocharger, and should only be used for brief periods of time.

For drag launches, there is a 2D table IgnTrimLaunchMap [deg] that can be used to trim ignition timing when the 2Step Spark limiter is active and Launch Retard activation conditions are met.

Launch Retard Enable

Launch Retard Active Above Throttle %

Launch Retard Active Above RPM rpm

Rolling Launch

For rolling launches, the ECU will prevent the engine from accelerating as long as the RollingLaunchSwitch is held, allowing the driver to use full throttle to spool the turbocharger while coasting at a constant speed. When the Throttle position is greater than the 'Launch Retard Active Above Throttle' value, ignition retard values from the table 'RollingLaunchIgnTrim' will be active. Use the Input Function Assignment page of the wizard to configure the RollingLaunchSwitch.

Rolling Launch Enable

(note that Rolling Launch Enable does not require Launch Retard Enable to be active)

▼ Hide Advanced Options

If 'LaunchBoostError' is assigned as one of the inputs for the 'IgnTrimLaunchMap [deg]' or 'RollingLaunchIgnTrim' tables, target boost for launch timing trims can be reassigned on the fly using the 1D table 'LaunchBoostTarget'

LaunchBoostTarget Input

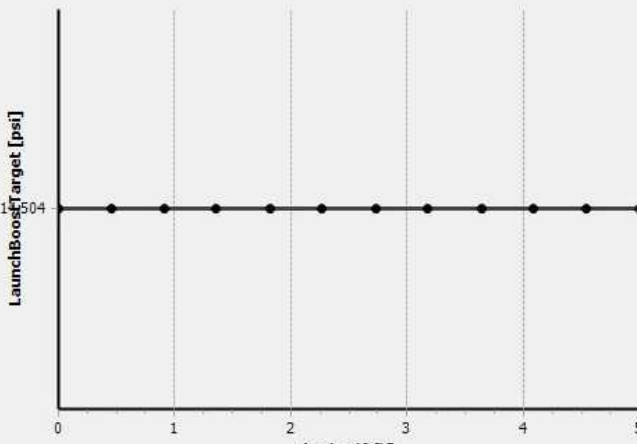

Analog10 [V]	LaunchBoostTarget [psi]
0.00	15
0.45	15
0.91	15
1.36	15
1.82	15
2.27	15
2.73	15
3.18	15
3.64	15
4.09	15
4.55	15
5.00	15

IgnTrimLaunchMap [deg] Table X-Axis

IgnTrimLaunchMap [deg] Table Y-Axis

RollingLaunchIgnTrim



MAP [kPa]	RollingLaunchIgnTrim Table [°]
75	0.00
100	0.00
125	0.00
150	0.00
175	0.00
200	0.00
225	0.00

An external 12 position switch allows the user to select a target launch boost. The system compares this value to the current manifold pressure and calculates a launch boost error. The launch boost error is an input to the IgnTrimLaunchTable.

Launch Retard Enable:

Enable or disables the launch retard feature

Launch Retard Active Above Throttle:

Throttle [%] must be above this value for the Anti Lag function to enable.

Launch Retard Active Above RPM:

EngineSpeed [RPM] must be above this value for the Anti Lag function to enable.

Rolling Launch Enable:

Enable the rolling launch feature.

LaunchBoostTarget [kPa] Table X-Axis:

Analog input for LaunchBoostTarget.

IgnTrimLaunchMap [deg] Table X-Axis:

Drop down menu of selectable axis inputs.

IgnTrimLaunchMap [deg] Table Y-Axis:

Drop down menu of selectable axis inputs.

Launch Timer

Launch Timer

The Launch Timer can be activated by holding and then releasing the 'ClutchSwitch' input. If a clutch switch is not used, this can be connected to the vehicle's line lock switch or trans brake switch. The timer becomes armed when the switch is held for longer than the 'Launch Timer Arm Time', then begins counting when the switch is released.

Launch Timer Enable

Launch Min Throttle %

Launch Timer Arm Time ms

'LaunchRampTime [ms]' is the output of the Launch Timer. It can be selected as an input to the 3-Step Limiter and BoostControl functions.

Launch Pedal Window ms

If the driver releases the throttle while the timer is counting, the Launch Timer will pause. If the throttle reaches Launch Min Throttle again before the 'Launch Pedal Window' time has expired, the timer will continue from the previous value from before it was paused.

Launch Timer Time Out ms

'If the Launch Timer counts above the Launch Timer Time Out' value, it will be reset to zero.

Launch Timer Enable:

Check box to enable or disable Launch Timer controls.

Launch Min Throttle:

Minimum Throttle [%] before launch timer can be activated

Launch Timer Arm Time:

Time to hold trigger before launch timer is activated

Launch Pedal Window:

Amount of time allowed between conditions to use Launch Timer

Launch Timer Time Out:

Time before launch timer pedal window resets to 0

Nitrous N2O

Wizard (v2.92 Build 07/25/2013) Model ID: 10.1501.05.1.1.92.3

Setup

- Basic
- Tuning Preferences
- Cam/Crank
- Ignition Sync
- Injector Setup
- Injector Flow
- Air Temperature
- Coolant Temperature
- Fuel Pressure
- Idle
- Manifold Pressure
- Main Rev Limiter
- Set Throttle Range
- Accel and Decel Fuel
- Barometric Pressure
- Boost Control
- Charge Out Pressure
- DBW Tuning
- Engine Protection
- Exhaust Pressure
- Input Function Assignments
- Knock Setup
- HighSide Assignment Tabl...
- Lambda Control
- Launch Antilag
- Launch Timer
- LowSide Assignment Tabl...
- Mass Airflow
- Nitrous N2O**
- Oil Pressure
- Rev Limit 2 Step
- Rev Limit 3 Step
- Shift Cut
- Traction Control
- Tacho
- Turbo Speed
- USB Logging
- User GPIOs
- Vehicle Speed
- Honda VTEC
- WC
- Diagnostics

Nitrous N2O

The ECU can activate a nitrous solenoid and trim fuel and spark for use with one-stage nitrous setups.

RPM Windowing: If all other conditions are met, Nitrous will turn on when EngineSpeed goes above the Nitrous RPM Min value. Nitrous will be disabled if the EngineSpeed goes above the Nitrous RPM Max value, and will stay disabled until the EngineSpeed goes below the Nitrous RPM Reinstae value.

Nitrous RPM Min rpm

Nitrous RPM Max rpm

Nitrous RPM Reinstae rpm

▼ Hide Nitrous Triggers: Arm Switch, Gear, VSS, Throttle, Boost

Nitrous Arm Switch input signal

After choosing which input to use for the Nitrous Arm Switch, on/off conditions must be configured in the 1D table 'N2O_Switch'.

Nitrous Minimum Gear

Nitrous Minimum Vehicle Speed mph

Nitrous TPS On Above %

Nitrous TPS Off Below %

Overboost Disable: If the Manifold Pressure exceeds MAP Max, Nitrous will be disabled until the Manifold Pressure goes below the MAP Reinstae value.

Nitrous MAP Max kPa(abs)

Nitrous MAP Reinstae kPa(abs)

Nitrous Output and Trims

When Nitrous is active, The ECU will use the trim values from the 2D fuel trim table 'N2O_Fuel [%]' and the 2D ignition trim table 'N2O_Ignition [deg]'.

The ECU can adjust the LambdaTarget using the 'Nitrous Lambda Target Trim' value above if a richer or leaner LambdaTarget is desired while nitrous is active; this can prevent closed-loop feedback from fighting the adjustments made by the N2O_Fuel trim table.

Nitrous Lambda Target Trim

To enable a nitrous solenoid output pin, use the 'LowSide Assignment Tables' wizard or 'HighSide Assignment Tables' wizard to set the desired output pin's table to use the 'N2O_Output' function. Configure the output pin's 2D table to activate the output when 'N2O_Output' is 1 (ON).

Nitrous RPM Min:

Units: RPM

If all other conditions are met, Nitrous will turn on when EngineSpeed [RPM] reaches this value.

Nitrous RPM Max:

Units: RPM

Maximum EngineSpeed [RPM] before Nitrous turns off.

Nitrous RPM Reinstate:

Units: RPM

EngineSpeed [RPM] to turn Nitrous back on.

Nitrous Triggers: Arm Switch, Gear, VSS, Throttle, Boost:**Nitrous Minimum Gear:**

Units: Gear

Lowest gear for enabling Nitrous

Nitrous Minimum Vehicle Speed:

Units: Gear

Lowest vehicle speed for enabling Nitrous

Nitrous TPS On Above:

Units: Throttle %

Minimum value for TPS [%] to enable Nitrous

Nitrous TPS Off Below:

Units: Throttle %

Maximum value for TPS [%] before Nitrous is turned off

Nitrous MAP Max:

Units: Pressure

Maximum value for MAP before Nitrous is turned off.

Nitrous MAP Reinstate:

Units: Pressure

MAP must drop below this value before Nitrous is turned back on.

Nitrous Output and Trims:**Nitrous Lambda Target Trim:**

Value to adjust LambdaTarget by leaving alone or or leaning it out during Nitrous. Min value = -0.2, Max value = 0.

Nitrous Trims: Advanced Setup:**Nitrous Output Delay:**

Units: Time

Nitrous Trim Delay:

Units: Time

Nitrous Trim Decay Time:

Units: Time

Associated Tables:**N2O_Switch:**

Units: Off = 0, On = 1

This table sets digital input condition to arm Nitrous, Set all cells to 1 if not using a digital input to arm.

N2O_Fuel:

Units: Pressure vs Engine Speed vs Fuel % (decimal)

Range: Min value = -1.00, Max value = 1.55

This map allows a percentage of additional fuel to be added or subtracted from the base map when the nitrous options become active. This map allows adjustment over engine speed and manifold pressure.

N2O_Ign [deg]:

Units: Pressure vs Engine Speed vs Degrees

Range: Min value = -43.75, Max value = 20.00

This map allows ignition timing to be advanced or retarded against the base ignition map when the nitrous control is active. This map is adjustable over engine speed and manifold pressure.

Main Rev Limiter

Main Rev Limiter

The Main Rev Limit settings can be used to cut fuel or spark when the Engine Speed [RPM] is above a safe value.

Rev Limit: Fuel Cut rpm

Rev Limit: Spark Cut rpm

Rev Limit: Ignition Retard rpm

Rev Limit: Ignition Retard Amount degrees BTDC

▼ Hide Advanced Setup

The Fuel/Spark Cut Start Window settings can be used to adjust how early the Rev Limiters are allowed to become active.

Fuel Cut Start Window rpm

Spark Cut Start Window rpm

The Rev Limit PID settings can be adjusted to change the 'feel' or 'harshness' of the limiter. Values that are too high tend to cause excess EngineSpeed fluctuation, while values that are too low can allow the EngineSpeed to exceed the desired RPM Limit.

Fuel Cut Gain: P

Fuel Cut Gain: I

Fuel Cut Gain: D

Spark Cut Gain: P

Spark Cut Gain: I

Spark Cut Gain: D

Close

v2.94 Build 12/04/2013

Rev Limit Fuel Cut:

Desired RPM for the main limiter fuel cut. Set to an unattainable RPM value to disable.

Min value = 2000 RPM, Max Value = 20,000 RPM

Rev Limit Spark Cut:

Desired RPM for the main limiter spark cut. Set to an unattainable RPM value to disable.

Min value = 2000 RPM, Max Value = 20,000 RPM

Rev Limit Ignition Retard:

Option to retard ignition timing during main limiter operation. Sometimes desirable on N/A applications to smooth the feel of the limiter. Set to an unattainable RPM value to disable. **Note: Using ignition retard while on the main limiter is not recommended for turbocharged applications.**

Min value = 2000 RPM, Max Value = 20,000 RPM

Ignition Retard Amount:

Desired ignition retard while on main limiter and ignition retard active.

Min value = 0 deg, Max Value = 30

Fuel Cut Start Window:

Adjusts how early the fuel rev limiter is allowed to become active. This is an amount BELOW your target cut RPM.

Min value = 0 deg, Max Value = 300

Spark Cut Start Window:

Adjusts how early the spark rev limiter is allowed to become active. This is an amount BELOW your target cut RPM.

Min value = 0 deg, Max Value = 300

Rev Limit 2Step

Rev Limit 2 Step

The 2-Step limiter holds the Engine Speed at a certain RPM to allow consistent launches at the starting line.

2 Step Fuel Cut Enable

2 Step Spark Cut Enable

2 Step Activation Criteria

2 Step Maximum Vehicle Speed [mph](#)

The 2-Step limiter will be active when the 'ClutchSwitch' signal is on and Vehicle Speed is below the '2 Step Maximum Vehicle Speed' limit.

Ignore Clutch Switch

If 'Ignore Clutch Switch' is selected, the 2 Step limiter will be activated by Vehicle Speed only.

2-Step Target RPM can be configured in the 2StepTargetFuel [RPM] and 2StepTargetSpark [RPM] tables.

▼ Hide Advanced Setup

An external 12 position switch allows the user to adjust the target 2-Step launch RPM at the starting line. After selecting which input pin to use, adjust the values in the 2StepTargetFuel [RPM] and 2StepTargetSpark [RPM] tables to set the desired launch RPM depending on input pin voltage.

2 StepTarget table inputs

It is not recommended to use the 'Clutch Switch invert' option, it is scheduled to be removed from future firmware versions. Please set 'Clutch Switch Invert' to off and adjust the values in the 1D table 'ClutchSwitch' so the table output is 1 when the clutch is pressed.

Clutch Switch Invert

Main rev limiters are found at the end of the engine's power band. Secondary rev limiters (2 step) are most commonly used in drag racing for consistent vehicle launches. However, secondary rev limiters can also be used for full throttle shifting, anti-lag, valet parking, etc.

2 Step Fuel Cut Enable:

Use a fuel cut for the launch limiter. This can be used along or combined with spark cut.

2 Step Spark Cut Enable:

Use a spark cut for the launch limiter. This can be used alone or combined with fuel cut.

2 Step Maximum Vehicle Speed:

Allows the user to disable the 2 step limiter when the vehicle begins moving. This is the only option that will disable the 2Step when a clutch switch is not installed on the vehicle. This requires a properly functioning and calibrated vehicle speed sensor.

Ignore Clutch Switch:

If this option is active, the ECU ignores the ClutchSwitch input and allows the user to enable the 2 Step function using vehicle speed only. This can be useful if a clutch switch is not installed on the vehicle.

2 Step Target table inputs

Allows the user to reassign the input voltage for the 2StepTargetFuel and 2StepTargetSpark tables. Wiring a 12-position switch can allow the driver to quickly adjust the desired launch RPM without connecting a laptop to the ECU.

2StepTargetFuel Table

Units: RPM vs Launch Target Analog In

Description: This table sets a variable 2Step RPM fuel cut via a 0-5V analog input from a potentiometer.

2StepTargetFuel [RPM]											
4000	4000	4000	4000	4000	4000	4000	4000	4000	4000	4000	4000
0	0.45	0.91	1.36	1.82	2.27	2.73	3.18	3.64	4.09	4.55	5
LaunchTargetAnalogIn											

2StepTargetSpark Table

Units: RPM vs Launch Target Analog In

Description: This table sets a variable 2Step RPM spark cut via a 0-5V analog input from a potentiometer.

2StepTargetSpark [RPM]											
4000	4000	4000	4000	4000	4000	4000	4000	4000	4000	4000	4000
0	0.45	0.91	1.36	1.82	2.27	2.73	3.18	3.64	4.09	4.55	5
LaunchTargetAnalogIn											

LaunchBoostTarget Table

Units: Boost Target vs Launch Target Analog In

Description: This table sets a variable launch boost target via a 0-5V analog input from a potentiometer.

LaunchBoostTarget [kPa]											
100	100	100	100	100	100	100	100	100	100	100	100
0	0.45	0.91	1.36	1.82	2.27	2.73	3.18	3.64	4.09	4.55	5
LaunchTargetAnalogIn											

IgnTrimLaunch Table

Units: Ignition Degree Trim vs Launch Boost Error

Description: Retarding ignition timing will increase turbo response. On the other hand, advancing ignition timing will slow turbo response. This table can set an ignition retard based on the amount of undershooting of the launch boost target. Conversely, an ignition advance can be added based on the amount of overshooting of the launch boost target.



Rev Limit 3Step

Rev Limit 3 Step

The 3-Step function can be used to limit wheel-slip. The wheels used to calculate Vehicle Speed must not be slipping, this can be configured in the Vehicle Speed setup.

3 Step Fuel Cut Enable

3 Step Spark Cut Enable

Using the tables '3StepTargetFuel [RPM]' and '3StepTarget_Spark [RPM]', a maximum desired Engine Speed can be configured depending on Vehicle Speed. If 3-Step is enabled and the Engine Speed increases above the 3-Step limit, the ECU will cut fuel or spark to prevent excessive slip.

Hide Advanced Setup

For very powerful vehicles that spin the rear tires and lift the front tires, the VehicleSpeed calculation may not be accurate enough for 3 Step use. It may be preferable to use the LaunchRampTime[ms] as the input for the 3 Step tables. See the wizard page 'Launch Timer' for more details.

3 StepTarget Fuel X-Axis

3 StepTarget Spark X-Axis

3 StepTarget Spark Y-Axis

The 3Step Rev Limiter is a simplistic traction control system that is commonly used in race series that do not permit wheel speed sensors. Instead this system uses the transmission's vehicle speed sensor along with the crank sensor(engine speed) to limit the amount of tire slip. There are two tables (3StepFuelCut and 3StepSparkCut) that are associated with the following channels.

3 Step Fuel Cut Enable:

Enable or disables the fuel cut 3 step feature.

3 Step Spark Cut Enable:

Enable or disables the spark cut 3 step feature.

The 3Step Target tables shown above are used in conjunction with the setup wizard options.

The 3Step Rev Limiter is a simplistic traction control system that is commonly used in race series that do not permit wheel speed sensors. Instead, this system uses the transmission's vehicle speed sensor along with the crank sensor (engine speed) to limit the amount of tire slip.

3StepTargetFuel Table

Units: RPM vs VehicleSpeed

Description: This table sets at what engine speed and vehicle speed the fuel will be cut in order to manage engine power and maintain traction.

8000	8000	8000	8000	8000	8000	8000	8000	8000	8000	8000	8000	8000	8000	8000	8000	8000	8000	8000	8000
0	20	40	60	80	100	120	140	160	180										
VehicleSpeed [MPH]																			

3StepTargetSpark Table

Units: RPM vs Selectable axes

Description: This table sets at what engine speed and vehicle speed the spark will be cut in order to manage engine power and maintain traction.

4	5000	5000	5000	5000	5000	5000	5250	5650	6100	6400	6850	7200	7550	8000	8400	9000	9900		
3	5000	5000	5000	5000	5000	5000	5500	6000	6550	7300	8100	8900	9500	10000	10000	10000	10000		
2	5000	5000	5000	5000	5500	6000	6700	7350	8600	9400	10000	10000	10000	10000	10000	10000	10000		
1	7500	7500	8100	9000	10000	10000	10000	10000	10000	10000	10000	10000	10000	10000	10000	10000	10000		
	0	10	20	30	40	50	60	70	80	90	100	110	120	130	140	150	160		
VehicleSpeed [MPH]																			

Shift Cut

Shift Cut

The ECU can decrease engine power for quick and consistent gear shift events while the driver holds full throttle. Power reduction can be achieved by a combination of ignition retard, fuel cut, and spark cut in response to a switch, a clutch pressure sensor, or a switch/strain gauge mounted to the shift lever. Use the 'Input Function Assignment' page of the wizard to configure the 1D table 'ShiftSwitch'.

Shift Cut Activation

Shift Cut Minimum RPM rpm

Shift Cut Minimum Throttle %

Shift Cut Re-Arm Delay Time ms

Shift Cut Method

Shift cut time can be adjusted for each gear using the 1D table 'ShiftCutTime'. After the cut time has been completed, ignition timing retard can be 'ramped out' over a certain amount of time to decrease drivetrain shock when power is reapplied.

Ign Retard Amount degrees BTDC

Ign Retard Ramp-Out Time ms

The ECU can decrease engine power for quick and consistent gear shift events while the driver holds full throttle. Power reduction can be achieved by a combination of ignition retard, fuel cut, and spark cut in response to a clutch switch, a clutch pressure sensor, or a switch or strain gauge mounted to the shift lever. Shift cut time can be adjusted for each gear using the "ShiftCutTime" table. After the cut time has been completed, ignition timing retard can be "ramped-out" over a certain amount of time to decrease drive-train shock when power is reapplied.

Shift Cut Activation

Shift Cut Minimum RPM:

Shift Cut will be disabled below this RPM. Set this value high enough to prevent shift cut from triggering when shifting into gear from idle.

Min value = 1500 RPM, Max value = 20000 RPM

Shift Cut Minimum Throttle:

Shift cut will be disabled below this throttle position. Set this value high enough to prevent shift cut from triggering when cruising at low throttle positions.

Min value = 5%, Max value = 100%

Shift Cut Re-Arm Delay Time:

Shift cut should be disabled for a short time after each cut event, to prevent double-triggering if the switch or sensor 'bounces' and sends an additional shift signal.

Min value = 600 ms, Max value = 2000 ms

Shift Cut Method:

Use this list to select the method of reducing engine power during the shift cut. Possible methods are:

Ignition Retard only

Ignition Retard + Fuel Cut
 Ignition Retard + Spark Cut
 Ignition Retard + Fuel and Spark Cut

Ign Retard Amount:

This is the total amount of ignition retard to allow while the shift cut is active, and the starting point for ignition retard ramp-out after the cut turns off. Set this to zero if you do not wish to retard timing after the shift cut.
 Min value = 0 degrees, Max value = 30 degrees

Ign Retard Ramp-Out Time:

This is the amount of time it takes for the ignition retard to be ramped out to zero after the shift cut turns off.
 Min value = 10 ms, Max value = 500 ms

Shift Cut Time

The Shift Cut feature allows no-lift-shifting for quick and consistent gear shifts without lifting the throttle. No-lift-shifting can also help minimize boost drop between gears for turbocharged vehicles. Power reduction can be achieved by a combination of ignition retard, fuel cut, and spark cut in response to a clutch switch, a clutch pressure sensor, or a switch or strain gauge mounted to the shift lever.

ShiftSwitch

Units: Voltage conditions for Switch On / Off

Description: This table allows the tuner to define which voltages represent the switch 'ON' position and which voltages represent the switch 'OFF' position. For instance, the example below would be useful for a strain gauge installed on the shift lever of an H-pattern gearbox. The resting voltage may be between 2.0 - 3.0V. When the shift lever is pressed forward, the strain gauge voltage goes below 1.99V, so we set the table to '1' because we want to trigger a ShiftCut event. When the shift lever is pulled back, the strain gauge voltage will go above 3.01V, so we set the table to '1' because we want to trigger a ShiftCut event. Please note the shift cut event will only be triggered if all other conditions including RPM and throttle position are met, see the [Shift Cut](#)^[219] section of the wizard for further description of the other conditions.



Shift Cut Time

Units: mS vs Gear

Description: If all the conditions for shift cut are met, the Infinity ECU will cut fuel or spark and retard ignition timing for this amount of time once the ShiftSwitch turns on. The cut time depends on which gear the transmission is currently in. A typical conservative value is 300mS.

ShiftCutTime [ms]							
500	500	500	500	500	500	500	500
0	1	2	3	4	5	6	7
Gear							

The datalog below shows a vehicle with a sequential gearbox shifting from 4th gear to 5th gear without lifting the throttle. On this vehicle, an on/off switch was installed on the shift lever so the switch sends ground when the lever is pulled to up-shift.

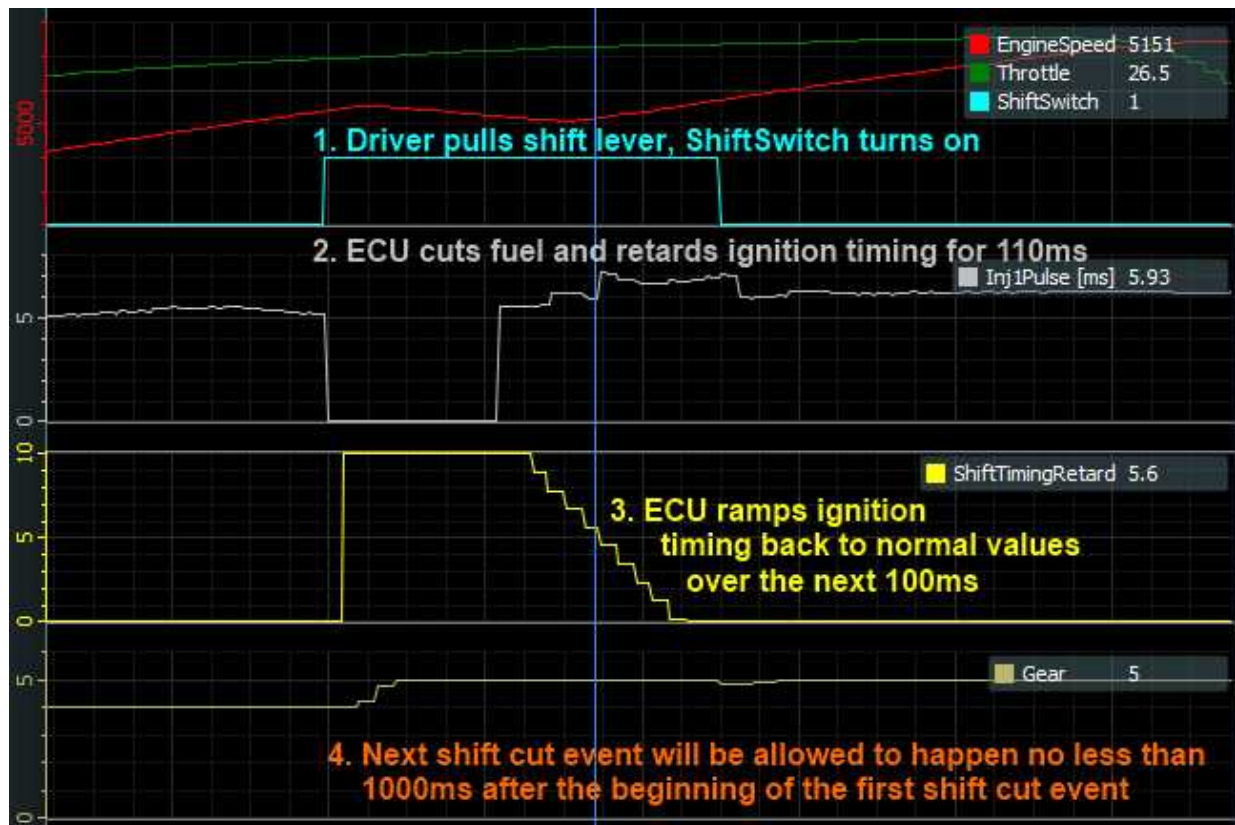

The following values were used in this example:

Shift Cut Minimum RPM = 3000 RPM
 Shift Cut Minimum Throttle = 20%
 Shift Cut Re-Arm Delay Time = 1000 ms

ShiftCutTime = table set to 110ms for 4th gear
 Shift Cut Method = Ign Retard + Fuel Cut
 Ign Retard Amount = 10 degrees
 Ign Retard Ramp-Out Time = 100ms

For more information, see the [Shift Cut](#) ²¹⁹ section of the wizard.

Traction Control

With individual wheel speed sensors installed, the ECU can measure front vs rear speeds and limit engine power to prevent excessive wheel slip. Desired wheel slip depends on the calculated gear position and a driver-adjustable trim knob or switch.

AEM Infinity-8

Traction Control

With individual wheel speed sensors installed, the ECU can measure front vs rear speeds and limit engine power to prevent excessive wheel slip. Desired wheel slip depends on the calculated gear position and a driver-adjustable trim knob or switch.

Traction Control Basic Activation

Traction Control Enable	<input type="checkbox"/>
Traction Control Armed Above RPM	2000 rpm
Traction Control Armed Above Throttle	25 %
Traction Control Armed Above GroundSpeed	0.0 mph
Traction Control Armed Above Drive/WheelSpeed	0.0 mph

Traction Control Method

TC Fuel Cut Enable	<input checked="" type="checkbox"/>
TC Spark Cut Enable	<input type="checkbox"/>
TC Ignition Retard Enable	<input checked="" type="checkbox"/>

Note that the 2D table 'TC_TqReduceDBW' will always be active, set all table values to zero if you wish to prevent the drive-by-wire-throttle from closing due to traction control calculations.

▼ Hide Advanced Options

Traction Control SlipTargetGear Input Setup: Gear

TC Gain PID factors can be adjusted to change the amount of 'TC_TqReduceReq' that gets calculated when the value 'TC_SlipMeasured' exceeds 'TC_SlipTarget'. The value 'TC_TqReduceReq' is an input to the 2D tables 'TC_TqReduceTiming', 'TC_TqReduceSpark [Cut%]', 'TC_TqReduceFuel [Cut%]' and 'TC_TqReduceDBW' which can be used to control the system response to undesired slip.

TC Gain (Proportional)	3.000
TC Gain (Integral)	0.000
TC Gain (Derivative)	0.000
TC Integral Clamp L	0
TC Integral Clamp H	100

The 1D table 'TC_SlipTargetTrim [MPH]' can be used to adjust the desired amount of slip while the vehicle is running. Use the 'Input Function Assignment' page of the wizard to configure the 1D table 'TC_SlipTargetTrim [MPH]'.

Traction Control Basic Activation

Traction Control Enable**Units:** ON/OFF**Description:** This enables the traction control feature.**Traction Control Armed Above RPM****Units:** RPM**Description:** This is the RPM activation threshold for traction control. When the engine speed is above this value, traction control will be active.**Traction Control Armed Above Throttle****Units:** Throttle %**Description:** This is the throttle activation threshold for traction control. When the throttle is above this percentage, traction control will be active.**Traction Control Method****Traction Control Method****Units:** Cut Selection**Description:** In order to manage power and maintain traction, one of the following three engine cuts should be selected; fuel cut only, spark cut only, or fuel and spark cut.**Advanced Options****Traction Control Slip Target Gear Setup**

Select the desired input for the TC_SlipTrgtGear table

Fuel Cut Gain (Proportional)**Units:** Proportional Gain**Description:** Proportional control is a pure gain adjustment acting on the error signal to provide the driving input. If overshooting occurs, lower this value. If undershooting occurs, raise this value.**Fuel Cut Gain (Integral)****Units:** Integral Gain**Description:** Integral control is implemented through the introduction of an integrator. Integral control is used to provide the required accuracy for the control system. This is used to fine tune once the proportional has acted in getting close to the target.**Fuel Cut Gain (Derivative)****Units:** Derivative Gain**Description:** The derivative term slows the rate of change of the controller output. Derivative control is used to reduce the magnitude of the overshoot produced by the integral component and improve the combined controller-process stability. Note: start tuning with this option at zero. Once the proportional and internal term has the lambda close to the target, step this gain in slowly until the target is achieved.**Spark Cut Gain (Proportional)****Units:** Gain**Description:** Proportional control is a pure gain adjustment acting on the error signal to provide the driving input. If overshooting occurs, lower this value. If undershooting occurs, raise this value.**Spark Cut Gain (Integral)****Units:** Gain**Description:** Integral control is implemented through the introduction of an integrator. Integral control is used to

provide the required accuracy for the control system. This is used to fine tune once the proportional has acted in getting close to the target.

Spark Cut Gain (Derivative)

Units: Gain

Description: The derivative term slows the rate of change of the controller output. Derivative control is used to reduce the magnitude of the overshoot produced by the integral component and improve the combined controller-process stability. Note: start tuning with this option at zero. Once the proportional and internal term has the lambda close to the target, step this gain in slowly until the target is achieved.

TC Integral Clamp H

Units:

Description: High clamp for traction control integral component

TC Integral Clamp L

Units:

Description: Low clamp for traction control integral component

TC SlipTrgtGear [MPH] Table

Units: Wheel Slip MPH vs Gear

Description: This the main traction control target table. As an example, if the front tires (non-driven wheel speed) register 50mph and the rears (driven wheel speed) register 80mph, the channel TC_SlipMeasured [MPH] will calculate 30 mph. If the TC_SlipTarget [MPH] channel entered in this table is 20mph, the ECU will calculate a TC_TqReduceReq value, to reduce engine torque.

TC_TargetGear									
20	20	15	10	5	5	5	5	5	5
0	1	2	3	4	5	6	7	8	9
Gear									

TC TargetTrim Table

Units: Wheel Slip MPH vs Analog14 Volts

Description: This table allows for a programmable variable slip to be integrated via a dash mounted potentiometer. By default, this 0-5V signal needs to be input on Infinity pin function Analog-14. The value here will offset the TC_SlipTarget [MPH] accordingly.

TC_TargetTrim											
0	1	2	3	4	5	6	7	8	9	10	11
0.1	0.45	0.91	1.36	1.82	2.27	2.73	3.18	3.64	4.09	4.55	4.9
Analog14 [V]											

TC TqReduceFuel Table**Units:** Gear vs Torque Reduction vs Fuel Cut%**Description:** This table allows an array of fuel cut percentages to be defined depending on which gear the vehicle is in and how much torque reduction was requested. 100% is a full fuel cut and 0% is no fuel cut.

Gear	TC_TqReduceReq									
	0	10	20	30	40	50	60	70	80	90
7	0	0	0	0	0	0	0	0	0	0
6	0	0	0	0	0	0	0	0	0	0
5	0	0	0	0	0	0	0	0	0	0

TC TqReduceSpark Table**Units:** Gear vs Torque Reduction vs Spark Cut%**Description:** This table allows an array of spark cut percentages to be defined depending on which gear the vehicle is in and how much torque reduction was requested. 100% is a full spark cut and 0% is no spark cut.

Gear	TC_TqReduceReq									
	0	10	20	30	40	50	60	70	80	90
7	0	0	0	0	0	0	0	0	0	0
6	0	0	0	0	0	0	0	0	0	0
5	0	0	0	0	0	0	0	0	0	0

USB Logging

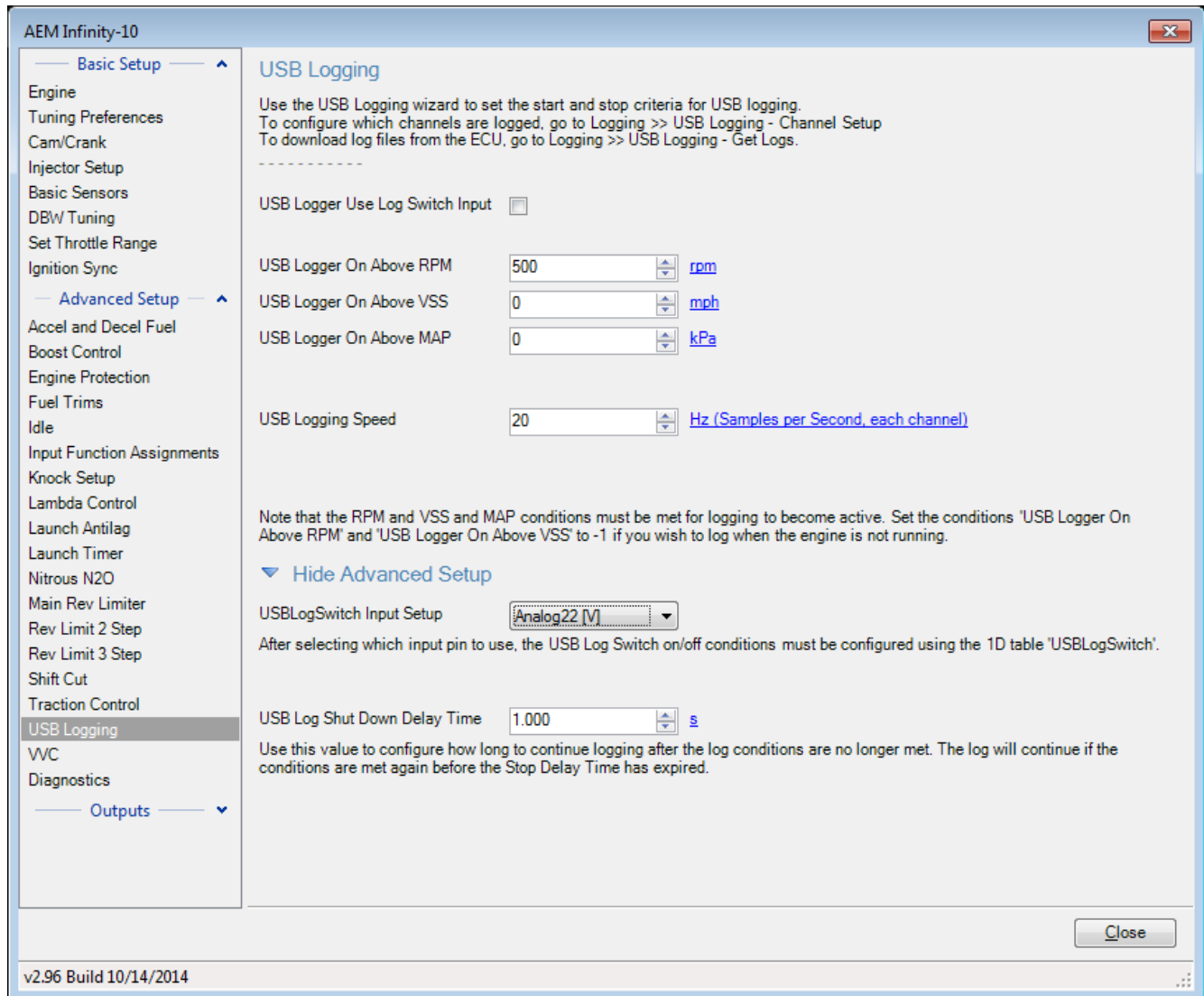

Use Log Switch Input:

Analog input on pin 35 of the 56-pin blue header. Analog voltage must be below 2.5 volts for this input to activate.

USB Logger On Above RPM:

Engine Speed must be above this value for logger to start logging.

USB Logger On Above VSS:

Vehicle Speed must be above this value for logger to start logging.

USB Logger On Above MAP:

Manifold Pressure must be above this value for logger to start logging.

USB Logging Speed:

Sample rate for channels selected.

Note: All of the above conditions must be true for the logger to start unless *Use Log Switch Input* is not checked. In this case, the analog input is ignored but all other conditions must still be true.

VVC

The Infinity ECU supports up to 4 channels of variable valve control (VVC). This support is application dependent. Contact AEM Tech Support for more information. The setup wizard UI pages contain text descriptions of all features and functions.

VVC

This wizard is used to configure Variable Valve Control (supports up to 4-cam VVC).

Assign the cam digital inputs used to their corresponding VVC name. Cams not used may be left on any selection. Failure to set VVC cam assignments properly may result in improper VVC function and possible engine damage!

VVC Enable

WC1A Enable	<input type="checkbox"/>	Intake - Bank 1
WC1B Enable	<input type="checkbox"/>	Intake - Bank 2
WC2A Enable	<input type="checkbox"/>	Exhaust - Bank 1
WC2B Enable	<input type="checkbox"/>	Exhaust - Bank 2

VVC Cam Sync

Cam sync is similar to ignition sync on an engine. Before setting cam sync be sure VVC cam assignments are properly setup. With all VVC channels disabled, start and idle the engine. The intake cam should be at full retard and the exhaust cam should be at full advance. These points will serve as the VVC cam zero reference. View the channels 'Cam0_Timing [deg]', 'Cam1_Timing [deg]', 'Cam2_Timing [deg]', 'Cam3_Timing [deg]' and enter the value of these channels here. View the cam timing channels again, they should all read zero or close to zero. If they do not read zero, add what they currently read to the current value below and check again.

Failure to set cam sync properly may result in improper VVC function and possible engine damage!

Cam 0 Sync [deg]	<input type="text" value="0"/>	°
Cam 1 Sync [deg]	<input type="text" value="0"/>	°
Cam 2 Sync [deg]	<input type="text" value="0"/>	°
Cam 3 Sync [deg]	<input type="text" value="0"/>	°

VVC Hardware Outputs

Use the Lowside Assignment Tables setup wizard to configure the Lowside outputs for the desired frequency [Hz] and duty [%]

VVC Target Table

VVC Target Table Load Axis Selection

VVC Minimum Coolant Temperature °C

Remember to use the Lowside Assignment tables in the [Output Assignments](#) ²³⁰ wizard page to configure the outputs properly. Remember these output frequency and duty tables are the last gate in the logic sequence and must be set correctly for proper function.

Configure the failsafe options and PID settings using the options below.

Setup

- Basic
- Tuning Preferences
- Cam/Crank
- Ignition Sync
- Injector Setup
- Injector Flow
- Air Temperature
- Coolant Temperature
- Fuel Pressure
- Idle
- Manifold Pressure
- Main Rev Limiter
- Set Throttle Range
- Accel and Decel Fuel
- Barometric Pressure
- Boost Control
- Charge Out Pressure
- DBW Tuning
- Engine Protection
- Exhaust Pressure
- Input Function Assignments
- Knock Setup
- HighSide Assignment Tabl...
- Lambda Control
- Launch Antilag
- Launch Timer
- LowSide Assignment Tabl...
- Nitrous N2O
- Oil Pressure
- Oil Temperature
- Rev Limit 2 Step
- Rev Limit 3 Step
- Shift Cut
- Tacho
- Traction Control
- Turbo Speed
- USB Logging
- User GPDs
- Vehicle Speed
- Honda VTEC
- WVC**
- Diagnostics

Hide WVC1 Options

WVC1 Failsafe Features

Set the WVC1 failsafe limits to the WVC range of the application's intake camshaft movement plus a 5 degree buffer. WVC1A or WVC1B failsafe will enable when WVC1A or WVC1B cam timing goes out of the failsafe range. When the failsafe is enabled, the WVC cam that is in failsafe will disable WVC control and feedback, retarding the intake cam until the failsafe conditions are no longer met.

Ex. If the application has 60 degrees of possible intake advance, set the 'WVC1 Failsafe Min' to -5 and the 'WVC1 Failsafe Max' to 65.

WVC1 Failsafe Min	-5	°
WVC1 Failsafe Max	60	°
WVC1 Feedback Min	-15	%
WVC1 Feedback Max	15	%
WVC1 Duty Min	0	%
WVC1 Duty Max	90	%

WVC1 PID Settings

WVC1 Proportional Gain	0.0000
WVC1 Integral Gain	0.0000
WVC1 Derivative Gain	0.0000

Hide WVC2 Options

WVC2 Failsafe Features

Set the WVC2 failsafe limits to the WVC range of the application's exhaust camshaft movement plus a 5 degree buffer. WVC2A or WVC2B failsafe will enable when WVC2A or WVC2B cam timing goes out of the failsafe range. When the failsafe is enabled, the WVC cam that is in failsafe will disable WVC control and feedback, advancing the exhaust cam until the failsafe conditions are no longer met.

Ex. If the application has 60 degrees of possible exhaust retard, set the 'WVC2 Failsafe Min' to -65 and the 'WVC2 Failsafe Max' to 5.

WVC2 Failsafe Min	-60	°
WVC2 Failsafe Max	5	°
WVC2 Feedback Min	-15	%
WVC2 Feedback Max	15	%
WVC2 Duty Min	0	%
WVC2 Duty Max	90	%

WVC2 PID Settings







WVC2 Proportional Gain	0.0000
WVC2 Integral Gain	0.0000
WVC2 Derivative Gain	0.0000

Diagnostics

The Diagnostics wizard page is not normally needed. It provides access to certain tuning options that rarely need changed and are primarily useful for testing and diagnostic purposes.

Diagnostics

The following list is for setup and debug purposes only. Contact AEM for information

Battery Filter	<input type="text" value="70"/>	 	%
Crank Maximum RPM	<input type="text" value="400"/>	 	rpm
Crank Minimum RPM	<input type="text" value="25"/>	 	rpm

Battery Filter:

Software filter for the .Battery [Volts] channel. Larger values provide more smoothing.









Crank Maximum RPM:

Maximum RPM for exiting cranking conditions. Typical value is 400 RPM.

Crank Minimum RPM:

Minimum RPM for entering cranking conditions. Typical value is 25 RPM.

The EngineSpeed calculation is updated each time a crank signal edge is detected. To avoid excessive fluctuation, the calculation is smoothed using the previous EngineSpeed value in addition to the updated speed calculated from the new crank edge. Higher values for CrankEdge RPM Smoothing Filter will increase the smoothing amount. Lower values will update the calculated EngineSpeed more quickly. Adjust this smoothing level with caution; the behavior of all fuel calculations and rev limiters depends on it.

CrankEdge RPM Smoothing Filter	<input type="text" value="95.0"/>	 	%
ECU Shutdown Time	<input type="text" value="5000"/>	 	ms
Engine Speed Filter Level	<input type="text" value="96.0"/>	 	%
Fuel Cut Feedback Window	<input type="text" value="200"/>	 	rpm

CrankEdge RPM Smoothing Filter:

Higher values will increase the smoothing amount. Lower values will update the engine speed calculation more quickly. Adjust this with caution as the behavior of nearly all major calculations depends on it.

ECU Shutdown Time:

The amount of time the ECU will stay powered up after the ignition switch is turned off.

Engine Speed Filter Level:

Software filter that affects the channel EngineSpeed Rate, the rate of change of engine speed. This is primarily used for certain idle control calculations.

Fuel Cut Feedback Window:

Used for certain fuel cut calculations. The fuel cut will begin this amount of RPM before the target cut RPM. Larger values will make the cut start to happen sooner. Smaller values may result in a certain amount of overshoot.

To avoid fluctuations in the commanded ignition timing, the calculated value from the IgnitionMap is smoothed by this percentage. Higher values will increase the amount of smoothing. Compare the logged values for IgnMap (which is not smoothed) to SpkTiming (which includes the smoothing factor plus other ignition trims) to view the effects of the filter.

Ignition Map Filter Level %

Spark Cut Control Window rpm

Ignition Map Filter Level:

Can be used to avoid fluctuations in commanded timing. Higher values will result in more smoothing.

Spark Cut Feedback Window:

Used for certain spark cut calculations. The spark cut will begin this amount of RPM before the target cut RPM. Larger values will make the cut start to happen sooner. Smaller values may result in a certain amount of overshoot.

Cam/Crank Sync Response when Not Synced	<input type="text" value="Ignore"/>
Cam/Crank Sync Response when Synced	<input type="text" value="Ignore"/>
Cam/Crank Sync Response when Sync Error Crank Tooth Missed	<input type="text" value="ReSync"/>
Cam/Crank Sync Response when Sync Error Crank Tooth Present	<input type="text" value="ReSync"/>
Cam/Crank Sync Response when Sync Error Primary Cam Signature	<input type="text" value="Ignore"/>
Cam/Crank Sync Response when Sync Error Secondary Cam Signature	<input type="text" value="Ignore"/>
Cam/Crank Sync Response when Sync Error Secondary 0 Cam Signature	<input type="text" value="Ignore"/>
Cam/Crank Sync Response when Sync Error Secondary 1 Cam Signature	<input type="text" value="Ignore"/>
Cam/Crank Sync Response when Sync Error Secondary 2 Cam Signature	<input type="text" value="Ignore"/>
Cam/Crank Sync Response when Sync Error Secondary 3 Cam Signature	<input type="text" value="Ignore"/>

Sync Response Settings:

Set automatically when crank and cam configuration settings are selected from the wizard. AEM does not recommend these values be changed unless specifically instructed to do so by an AEM technical representative.

Output Assignments

Most of the LowSide outputs include an output table for creating custom functions and all are capable of PWM. There is a 2D table with user adjustable x and y axis inputs for duty as well as a 1D table for controlling PWM. The axis selection and PWM frequency input must first be configured using the Setup Wizard on the LowSide Assignment Tables page:

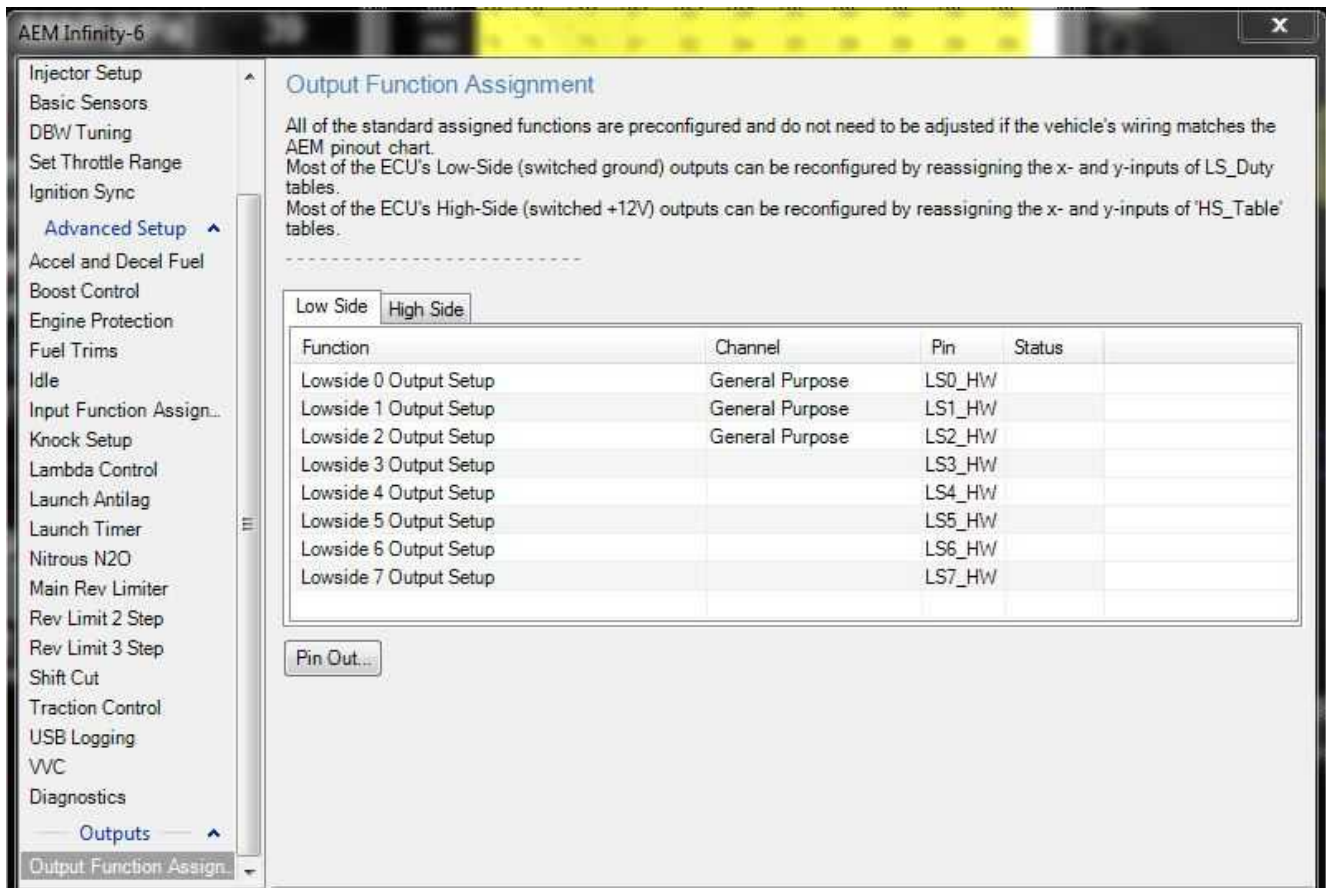

Some application specific models will contain unique output assignment pages. Example for the Porsche 997.1 application shown below. Consult the Plug and Play documentation for more information.

Output Function Assignment

All of the standard assigned functions are preconfigured and do not need to be adjusted if the vehicle's wiring matches the AEM pinout chart.

Most of the ECU's Low-Side (switched ground) outputs can be reconfigured by reassigning the x- and y-inputs of LS_Duty tables.

Most of the ECU's High-Side (switched +12V) outputs can be reconfigured by reassigning the x- and y-inputs of 'HS_Table' tables.

Porsche Expansion Low-Side (switched ground) outputs can be reconfigured by reassigning the x- and y-inputs of CAN_LS tables. These outputs are not PWM-able and can only be used as an on/off function.

Porsche Expansion Relay Drivers (switched ground) outputs can be reconfigured by reassigning the x- and y-inputs of CAN_RelayCtrl tables. These outputs are not PWM-able and can only be used as an on/off function in low current relay control circuits.

Function	Channel	Pin	Status
CAN Lowside 0 Output Setup	General Purpose	3-31	
CAN Lowside 1 Output Setup	CoolantFan2On	3-16	OFF
CAN Lowside 2 Output Setup	VTEC_Active	3-1 & 3-...	OFF

Pin Out...

Click on any available row to edit the modifiable data. Outputs can be configured as General Purpose or they can be assigned to specific functions. If a specific function is chosen, the wizard will present the user with a specific list of configuration choices. Note that all lowside outputs can be configured with either a fixed or variable frequency.

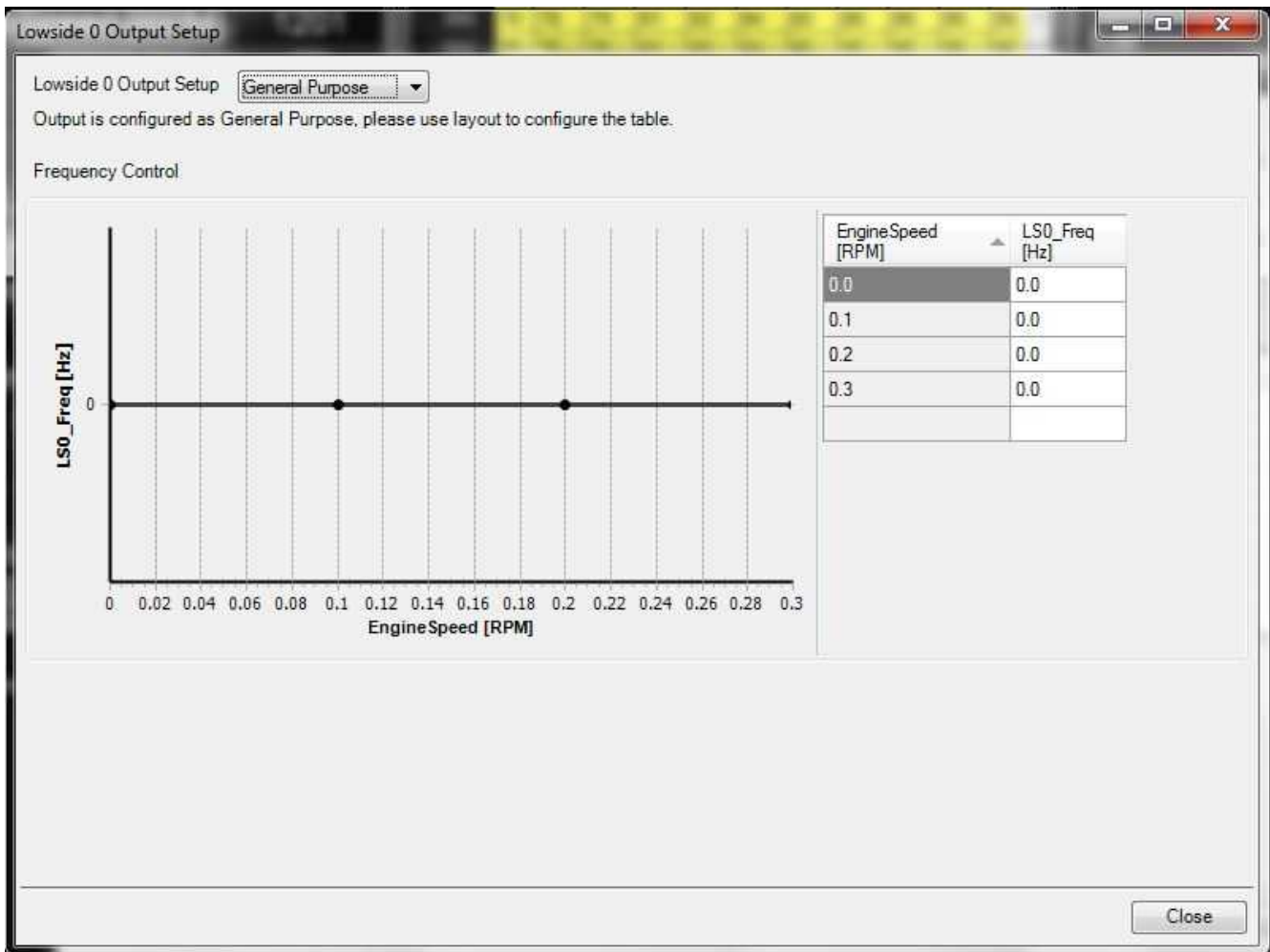

Unique, custom output setups are possible through manual editing of the LSX_Duty [%] tables as shown in the examples below.

Here's an example of combining the Coolant Fan control function with a LS Duty table to add an RPM dependent condition:



There is a trick or two here. To trigger a relay, we set the duty cycle to 100 when we want the relay to turn on, and 0 when we want the relay to turn off. In this case, we want the relay to turn on when the 'CoolantFan1On' condition is 1. Note that the second y-axis row is set to '0.5' and the third row is set to '1.0'. This is because the channel 'CoolantFan1On' is an internal logic flag that goes from 0 to 1 when the coolant fan temperature criteria are met. All of these tables include full interpolation between cells, so we set one of the RPM breakpoints to 499 and the next to 500 RPM to avoid spending much time between 0% and 100% duty cycle. This will set the LowsideSwitch_2 (LS2) output on pin C1-17 to trigger the relay when the CoolantFan1 condition is met and the EngineSpeed is 500 or greater. Always refer to the Infinity Pinout document located here --> \Documents\AEM\Infinity Tuner\Instructions for hardware limitations.

These tables are the last gate in the logic flow so regardless of anything that happens upstream, these tables can be used to tweak the logic as the user desires.

Here's an example using LS5 to control an alternator voltage regulator:

Battery [Volts]	1000	2000	3000	4000	5000	6000	7000
15	5	5	5	5	5	5	5
15	10	10	10	10	10	10	10
14	15	15	15	15	15	15	15
14	26	26	26	26	26	26	26
13	37	37	37	37	37	37	37
13	41	41	41	41	41	41	41
12	45	45	45	45	45	45	45

Here's an example using LS8 to control a PWM cooling fan function. The fan is disabled above 60 mph:

CoolantTemp [C]	0	10	20	30	40	50	60
100	94	94	75	57	38	19	0
90	60	60	48	36	24	12	0
80	25	25	20	15	10	5	0
70	10	10	8	6	4	2	0
60	0	0	0	0	0	0	0
40	0	0	0	0	0	0	0
0	0	0	0	0	0	0	0

Here's an example that simply passes through the 'VVC1A_Duty [%]' channel for VVC control:

WVCIA_Duty [%]	0	1000	2000	3000	4000	5000	6000
101	101	101	101	101	101	101	101
100	100	100	100	100	100	100	100
80	80	80	80	80	80	80	80
60	60	60	60	60	60	60	60
40	40	40	40	40	40	40	40
20	20	20	20	20	20	20	20
0	0	0	0	0	0	0	0

A few additional tips:

1. After selecting your axis input and closing the wizard. Save your layout and reopen it in Infinity Tuner for the changes to sync live in the table controls.
2. The same features apply to the available HighSide outputs too. The HighSides are limited to simple on/off operation though and are not PWM-able. Select the axis inputs the same way in the Setup Wizard then configure the output tables:
3. Always refer to the Infinity Pinout sheet to note any hardware limitations.

Coils / Injectors

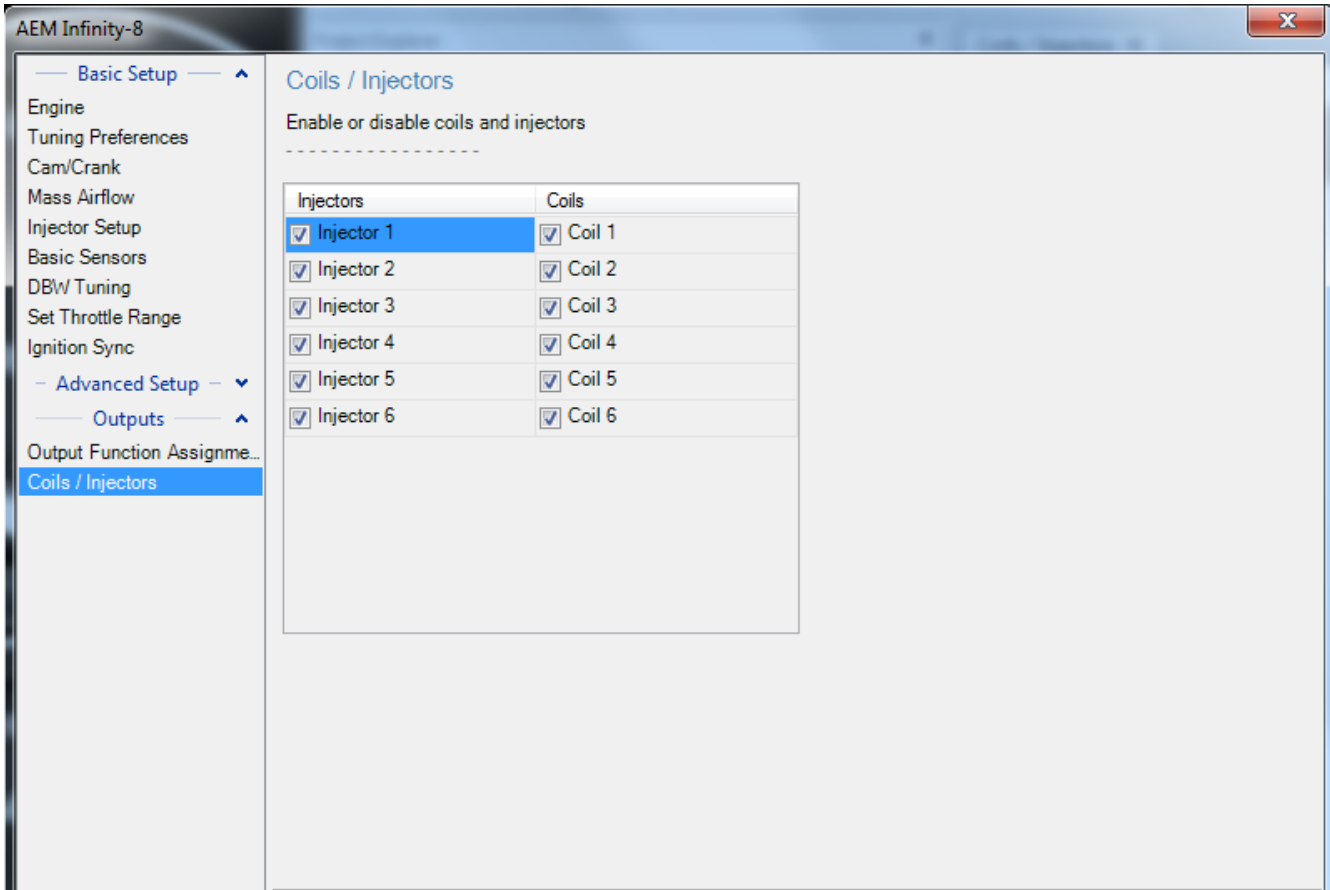

Select each output to enable or disable. The number of available outputs depends on the hardware platform.

Injector Control

The Infinity Tuner has integrated peak and hold injector drivers. In order to benefit from this feature, low impedance injectors must be used for high current triggering. The image below shows a sample capture of a 4 cylinder engine setup.

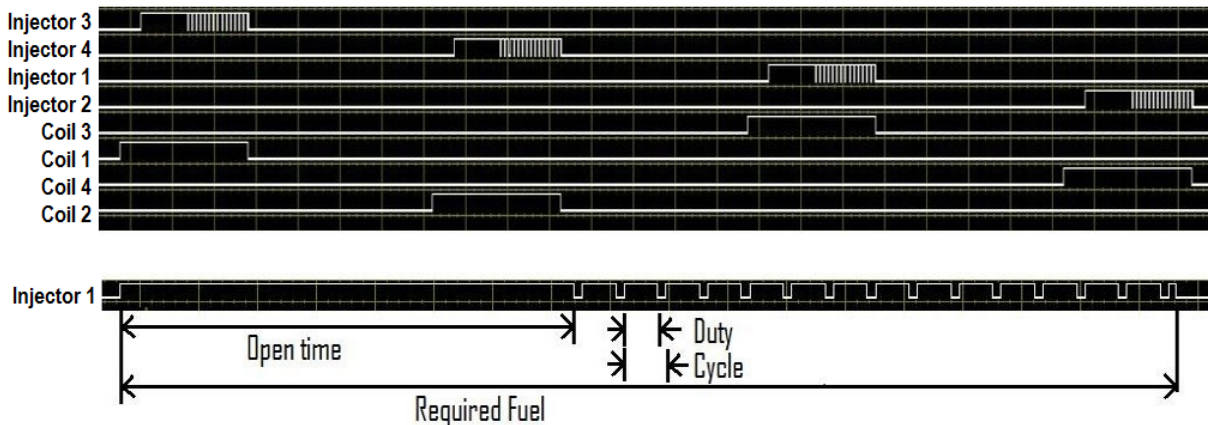

The fuel injector control is flexible enough to drive any multi-port fuel injector. A high impedance injector can be turned ON continuously whereas a low impedance injector would require a method to limit the current. A high impedance injector can set the duty time to 100% as this does not require a pulse width modulated current limiting phase. The injector waveform has several components that are controlled. Peak and hold control will hold the signal ON for the open phase and modulate the signal in order to limit the current.

ReqFuelX

Units: us/10

Description: This is the required fuel. The total time that the injector will be opened.

FI_OpenTimeX

Units: us/10

Description: This is the open time when the ECU will enable the low side injector driver circuit in a continuous fashion as to provide the current to open the injector.

FI_CyclTimeX

Units: us/10

Description: This is the cycle time of the PWM during the hold cycle of a low impedance injector. 1000 (0.1 milliseconds) would be a typical setting.

FI_DutyCycX

Units: %high

Description: This is the duty time. It should be set to 100 for high impedance injectors. This depends on the particular injectors current for the hold cycle of the injector. 40-60 are generally acceptable.

Injector Pressure

The fuel calculations in the Infinity ECU take fuel pressure into account as follows:

First the Manifold Pressure is calculated. MAP [psig] is calculated based on the MAP sensor and the Baro sensor (the baro sensor must be external, since the ECU enclosure is sealed).

Then, the Injector Pressure is calculated. InjPress [psig] is calculated based on the Fuel Pressure [psig] sensor and the MAP [psig] calculation. In other words, this is the pressure difference that is measured between the fuel rail (top of the injector) and the intake manifold (bottom of the injector).

Injector Pressure is used in a simple lookup table to determine InjFlowRate [cc/min]. Injector Pressure is also used as the y-axis of a simple lookup map to determine InjOffset[us]. InjOffset[us] is the injector response time, latency, offset, dead-time, etc.

If a fuel pressure sensor is not installed, or the fuel pressure voltage is outside the acceptable voltage range, the Infinity ECU will use a failsafe value for fuel pressure. When performing the failsafe calculations, the algorithm will check the fuel pressure regulator option (located in [Injector Flow](#)^[92]) which can tell the ECU that the fuel pressure regulator will be vacuum-referenced (FuelPressure failsafe will always assume X psi above manifold pressure, InjectorPressure will be constant) or atmosphere-referenced (FuelPressure failsafe will always assume X psi, and actual InjectorPressure will be influenced by MAP).

When using staged injection, there is a second set of InjFlowRate and InjOffset tables. Currently, the Infinity ECU assumes the fuel pressure is the same on both fuel rails.

InjectorOffset

Units: PSig vs Volts

Description: If a fuel pressure sensor is installed (see [Fuel Pressure](#)^[102]), injector pressure can be calculated. This is simply the pressure difference between intake manifold and fuel rail pressure. This table is used to setup the injectors' latency (response time) based on the injector pressure and battery voltage.

InjectorOffset [ms]					
InjPressure [psig]	100.0	3.000	1.900	1.400	1.200
	80.0	2.300	1.600	1.200	1.000
	60.0	1.900	1.400	1.100	0.800
	50.0	1.800	1.400	1.000	0.800
	40.0	1.600	1.200	1.000	0.800
		10.0	12.0	14.0	16.0
		Battery [Volts]			

InjSecOffset

Units: PSig vs Volts

Description: If a fuel pressure sensor is installed (see [Fuel Pressure](#)^[102]), secondary injector pressure can be calculated. This is simply the pressure difference between intake manifold and secondary fuel rail pressure. This table is used to setup the secondary injectors' latency (response time) based on the secondary injector pressure and battery voltage.

InjSecOffset [us/10]					
InjSecPressure [psig]	100.0	16000.0	11000.0	9500.0	7500.0
	80.0	16000.0	11000.0	9500.0	7500.0
	60.0	14000.0	10000.0	8000.0	6500.0
	50.0	13000.0	9500.0	7000.0	6000.0
	40.0	12000.0	9000.0	6000.0	5000.0
20.0	12000.0	9000.0	6000.0	5000.0	
		10.0	12.0	14.0	16.0
		Battery [Volts]			

InjFlowRate

Units: Injector Flow Rate vs Injector Pressure

Description: If a fuel pressure sensor is installed, injector pressure can be calculated. This is simply the pressure difference between intake manifold and fuel rail pressure. This table allows for an actual injector flow rate to be entered based on the injector pressure.

InjFlowRate [cc/min]					
InjPressure [psig]	60.0	180.0	350.0	500.0	770.0
	20.0	40.0	50.0	60.0	80.0

InjSecFlowRate

Units: Secondary Injector Flow Rate vs Injector Pressure

Description: If a fuel pressure sensor is installed, secondary injector pressure can be calculated. This is simply the pressure difference between intake manifold and secondary fuel rail pressure. This table allows for an actual secondary injector flow rate to be entered based on the injector pressure.



Flex Fuel Tuning

Flex Fuel is a fuel mixture of ethanol (alcohol) and gasoline. It is typically made from corn (or sugar cane) and is used for cleaner emissions, higher octane, and is less expensive per volume. However, ethanol's energy density is lower so gas mileage is compromised. But from a performance standpoint, the extra fuel lowers exhaust gas temperatures which is a benefit. Furthermore, ethanol has a higher latent heat of vaporization compared to gasoline so air charge cooling is further improved. When burning ethanol, the fuel tuning should be based on a oxygen sensor because reading spark plugs is much more challenging as the color is not as evident.

Flex Fuel Composition

Gasoline and ethanol have different compositions: Gasoline: H1.65C, Ethanol: C2H5OH. Ethanol has oxygen as part of its structure (gasoline does not) and is often referred to as "oxygenated gasoline". Because of this, the stoichiometry of the two fuels are drastically different.

Flex Fuel Stoichiometry

Gasoline stoichiometry: 14.68 AFR

"E85" stoichiometry: 9.87 AFR

Ethanol stoichiometry: 9.00 AFR

Flex Fuel Content

Most gas stations label their flex fuel as E85 (85% ethanol and 15% gasoline). However, this can be very misleading. Most cold climates use a winter blend which is E70. In order to determine the proper amount of blend that is being used at any given time, a FCS (fuel composition sensor) must be used.

Flex Fuel Sensors

AEM Sensors

Below is a list of flex fuel sensor kits available directly from AEM

30-2200 - Flex Fuel Sensor Kit, barbed fittings

30-2201- Flex Fuel Sensor Kit, -6 AN fittings

GM Sensors

Below is a list of part numbers associated with the GM FCS (Fuel Composition Sensor) unit:

GM 12570260, Fuel Composition Sensor, Quantity 1

Delphi 12146121, Connector, Quantity 1

Delphi 12048074, Terminals, Quantity 3

Delphi 12052845, TPA, Quantity 1

Delphi 15324973, Cable Seal, Quantity 3



Flex Fuel FCS Plumbing

The FCS should be plumbed into the system, preferably before the fuel injectors. It consists of 5/16" and 3/8" quick disconnect fittings. The internal microprocessor of the FCS outputs a varying digital square wave frequency and pulse width. The AEM Infinity decodes this input and displays a flex fuel content percentage and fuel temperature.

Flex Fuel FCS Wiring

There are 3 wiring terminals on the GM FCS. Pin A is Ground and should be connected to a clean chassis ground. Pin B is +12V and should be connected to a 12V ignition switch source. Pin C is the digital output signal and should be wired to AEM Infinity Pin C1-26 (Digital_In_5).

Flex Fuel FCS Output

The frequency of the signal indicates the ethanol percentage. The output frequency is linear with respect to the percentage of ethanol content in the fuel. The fuel composition sensor normally operates between 50-150Hz, where 50Hz represents 0% ethanol and 150Hz represents 100% ethanol. If the output frequency goes up to 170Hz, the sensor has gone into a fail safe mode as it has indicated a fuel contamination such as methanol, water, salt, etc. The pulse width indicates the fuel temperature and normally operates between 1-5mS where 1mS indicates -40°C (-40°F) and 5mS indicates 125°C (257°F).

Infinity Tuner Flex Fuel Tables

FlexCSensorCal

Units: Flex Content % vs Frequency Hz

Description: This table is used to find the flex fuel (ethanol) content based on the frequency input from the flex fuel sensor. See [Flex Content Input Setup](#)¹⁸⁷ to configure this table.

FlexCrankingAdder

Units: Flex Duty vs Flex Content % vs Injector Pulse us/10

Description: This table is used to increase the amount of engine cranking fuel injector pulse based on the fuel temperature and ethanol content. This an additional increase on top of the CrankVETable and LambdaCrankingTable. See the [Advanced Trims](#) ¹⁴⁰ section for additional setup options.

FlexDuty	0.0	0.3	0.5	0.8	1.0
120.0	0.0	0.0	0.0	0.0	0.0
80.0	0.0	0.0	0.0	0.0	0.0
40.0	0.0	0.0	0.0	0.0	0.0
20.0	0.0	0.0	0.0	0.0	10000.0
10.0	0.0	0.0	0.0	10000.0	10000.0
0.0	0.0	0.0	10000.0	20000.0	20000.0
-10.0	0.0	0.0	10000.0	30000.0	30000.0
-20.0	0.0	0.0	20000.0	30000.0	30000.0

LambdaFlexBlendTable

Units: Blend Factor vs FlexContent %

Description: This table is used to determine the final lambda target when using flex fuel. It blends the target lambda values between the LambdaTargetTable and the LambdaFlexTargetTable. The X-axis represents (ethanol) fuel content 0.0-1.0 (or 0-100% Ethanol). A value of 0.0 means 100% of the lambda target value will come from the LambdaTargetTable. A value of 1.0 means 100% of the lambda target value will come from the LambdaFlexTargetTable. As an example, a value of 0.3 means that 70% of the lambda target will come from the LambdaTargetTable and 30% from the LambdaFlexTargetTable.

FlexContent [%]	0.0	0.1	0.2	0.3	0.4	0.6	0.7	0.8	0.9	1.0
0.0	0.0	0.1	0.2	0.3	0.4	0.6	0.7	0.8	0.9	1.0

Multi-Map Tuning

Multiple maps can be utilized on the fly such as VE, Lambda, and Ignition to be switched manually with analog input or various conditions such as MAP [kPa] or gear. Several of these options are described in the Setup Wizard under Advanced Setup of Input Function Assignments. The following text describes examples of how this feature can be used. Many different options are possible and not all of them are described below.

Blending between multiple maps using ModeSwitch and FlexContent:

For Ignition, your calibration is already using the 1D table 'ModeSelect_Ign' to switch between two ignition maps:

When ModeSwitch = 1, use IgnMap

When ModeSwitch = 2, use IgnMap_2

There are two more things you need to configure. First, you need to understand how the ECU blends because of the ethanol content. There is a 1D table called 'IgnBlendTable.' The input to the table is FlexContent [%], and the output is a blend amount.



For now, let's assume you leave the original numbers in the 'IgnBlendTable' and it will blend smoothly and evenly between the 'pump fuel' timing numbers when FlexContent = 0 (0% ethanol) and the 'flex fuel' timing numbers when FlexContent = 1.0 (100% ethanol). You could however, change the values in the table so the ECU uses 'pump fuel' timing numbers when Ethanol Content is 0–40% and switches to 'flex fuel' timing when Ethanol Content is 40% or greater. Do that by setting the table cell values to '0.00' for FlexContent breakpoints 0.0–0.4 , and '1.00' for FlexContent breakpoints 0.4–1.0.

But let's not touch that table at all yet, let's assume you want it to blend smoothly depending on ethanol content, as long as your ModeSwitch is in position 3.

With the flex fuel sensor, the ECU will blend between whatever map is defined in the 1D 'ModeSelect_Ign' table and whatever map is defined in the 'ModeSelect_IgnBlend' table. One way you could do it is set the tables to these values:

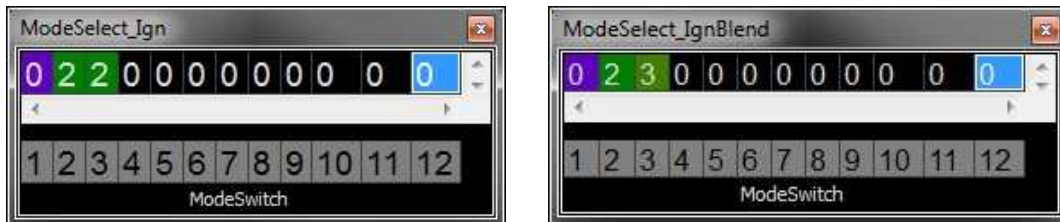

When ModeSwitch =1 the ECU will blend between IgnMap_1 (the top table ModeSelect_Ign gets used when the FlexContent is low), and IgnMap_1 (from the bottom table, ModeSelect_IgnBlend when FlexContent is high). In other words, there won't be any blend, it will use the main IgnMap timing values regardless of flex fuel content.

When ModeSwitch = 2 the ECU will use blend between IgnMap_2 (the top table ModeSelect_Ign gets used when the FlexContent is low), and IgnMap_2 (from the bottom table, ModeSelect_IgnBlend when FlexContent is high). Again, there won't really be any blending here, because we've told it to use the same map in both conditions.

When ModeSwitch =3 the ECU will blend between IgnMap_2 (from the top table, ModeSelect_Ign which gets used when FlexContent is low), and IgnMap_3 (from the bottom table, ModeSelect_IgnBlend when FlexContent is high). You can put the most aggressive timing numbers in IgnMap_3, and that timing map will only get used if the ModeSwitch = 3 and the FlexContent is high.

There are similar tables for LambdaTargets, you can adjust these if you want to run more aggressive lambda targets depending on ethanol content or other variables. See the ModeSelect_Lambda and ModeSelect_LambdaBlend 1D tables.

There are two different VE tables that can be used as well. Example screenshot below.

The screenshot displays the Infinity software interface with several key components:

- Text Grid:** Shows engine parameters such as EngineSpeed [RPM] (0), MAP [kPa] (345), Throttle [%] (100.0), Lambda1 (1.01), Lambda2 (0.00), LambdaTarget (0.00), Inj1LambdaFB (0.00), Inj2LambdaFB (0.00), CoolantTemp [C] (100), AirTemp [C] (30), SpkTiming [degBTDC] (0.0), Inj1Pulse [ms] (0.0), VE [%] (0.0), and NewVE (NAN).
- VE_BlendTable:** A table with values ranging from 0.000 to 0.600, representing FlexContent [%].
- VETable [%]:** A 2D table showing VE values for MAP [kPa] (10 to 320) vs EngineSpeed [RPM] (500 to 5000). Values range from 45 to 115.
- VEtable_2 [%]:** A second 2D table showing VE values for MAP [kPa] (10 to 320) vs EngineSpeed [RPM] (500 to 5000). Values range from 45 to 115.
- 3D Plot:** A 3D surface plot of VE [%] vs EngineSpeed [RPM] and MAP [kPa], showing a color-coded surface representing the VE distribution.
- No Log Data:** A panel indicating that no data is currently being logged.

Note that the input axis data for the VE_BlendTable is user selectable in the setup wizard as shown below.

The screenshot displays the 'Setup' wizard interface. On the left is a navigation pane with 'Input Function Assign...' selected. The main area shows several configuration sections:

- Oil Temperature Input Setup:** Set to 'OT_sens [ohms]'. A note states: "After selecting which input pin to use, the Oil Temperature sensor calibration must be configured using the 1D table 'OilTempCal'."
- Flex Content Input Setup:** Set to 'Dig5 [Hz]'.
- Hide Advanced Setup: Reassignable Table inputs** (expanded):
 - IgnitionBlend Table x-axis:** Set to 'FlexContent [%]'. Note: "The IgnitionBlend table can be used to smoothly calculate a blend between the two Ignition maps currently selected by the tables 'ModeSelect_Ign' and 'ModeSelect_IgnBlend'."
 - LambdaFlexBlend Table x-axis:** Set to 'FlexContent [%]'. Note: "The LambdaFlexBlend table can be used to smoothly calculate a blend between the two Lambda Target maps currently selected by the tables 'ModeSelect_Lambda' and 'ModeSelect_IBlend'."
 - VE_Blend Table x-axis:** The dropdown menu is open, showing options: 'FlexContent [%]', 'Cam0_Timing [deg]', 'Cam1_Timing [deg]', 'Cam2_Timing [deg]', 'Cam3_Timing [deg]', 'ModeSwitch', 'FlexContent [%]', 'MAP [kPa]', 'VTEC_Active', and 'Gear'. 'FlexContent [%]' is selected. Note: "The VE_BlendTable can be used to smoothly calculate a blend between the main 'VETable' airflow map and the secondary 'VETable_2' airflow map."
 - FuelTrim_1 Table y-axis:** (No selection shown).
 - Flex Cranking Adder Table y-axis:** (No selection shown). Note: "The FlexCrankingAdder Table can be used to add injector pulse width during cranking based on flex content."

It might be beneficial to blend between the two available VE maps based on either CamX_Timing [deg] or VTEC state as these certainly influence the engine's VE.

Two different DBW target tables are available.

The screenshot displays the Infinity Tuner Version 2.95.6870 interface. It features several data tables and gauges:

- DBW Target Table 1:** A table with columns for EngineSpeed [RPM] (1000, 2000, 3000, 4000, 5000, 6000, 10000) and rows for DBW1_TPSA [%], DBW1_TPSB [%], DBW_APP1 [%], DBW_APP2 [%], and DBW1_Error_Current through DBW1_Error_Tracking. Values range from 0 to 95.
- DBW Target Table 2:** A table with columns for EngineSpeed [RPM] (1000, 2000, 3000, 4000, 5000, 6000, 7000) and rows for DBW1_TPSA [%], DBW1_TPSB [%], DBW_APP1 [%], DBW_APP2 [%], and DBW1_Error_Current through DBW1_Error_Tracking. Values range from 5 to 100.
- Gauges:** Two AEM gauges for DBW1_TPSA [%] and DBW1_TPSB [%], both showing 0.0. A large digital display shows DBW1_Error_Fatal as 0.
- ModeSelect_DBW:** A control panel with a dropdown menu set to 1 and a ModeSwitch button.
- Plot:** A graph area showing real-time data for EngineSpeed [RPM] = 0, Throttle [%] = 0, DBW_APP1 [%] = 0, DBW_Target [%] = 0, DBW1_TPSA [%] = 0, and DBW1_TPSB [%] = 0.

This close-up shows the ModeSelect_DBW control panel. It includes a dropdown menu with options 0, 1, 2, and 3, where option 1 is currently selected. Below the dropdown is a ModeSwitch button.

If the output from the Mode_Select_DBW channel is 1, the system will use the values in the DBW_ThrottleCurve1 table as shown below.

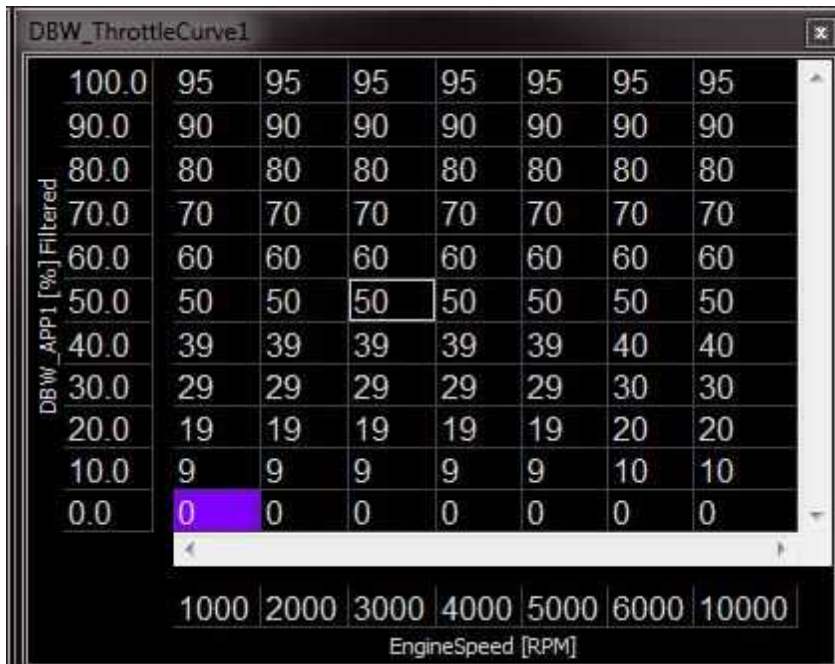

The screenshot shows a window titled "DBW_ThrottleCurve1" with a table of throttle position values. The y-axis is labeled "DBW_APP1 [%] Filtered" and ranges from 0.0 to 100.0 in increments of 10.0. The x-axis is labeled "EngineSpeed [RPM]" and has markers at 1000, 2000, 3000, 4000, 5000, 6000, and 10000. The table contains 8 columns of data. The value 0 is highlighted in the first column of the 0.0 row.

DBW_APP1 [%] Filtered	1000	2000	3000	4000	5000	6000	10000
100.0	95	95	95	95	95	95	95
90.0	90	90	90	90	90	90	90
80.0	80	80	80	80	80	80	80
70.0	70	70	70	70	70	70	70
60.0	60	60	60	60	60	60	60
50.0	50	50	50	50	50	50	50
40.0	39	39	39	39	39	40	40
30.0	29	29	29	29	29	30	30
20.0	19	19	19	19	19	20	20
10.0	9	9	9	9	9	10	10
0.0	0	0	0	0	0	0	0

If the output from the Mode_Select_DBW channel is 2, the system will use the values in the DBW_ThrottleCurve2 table as shown below.

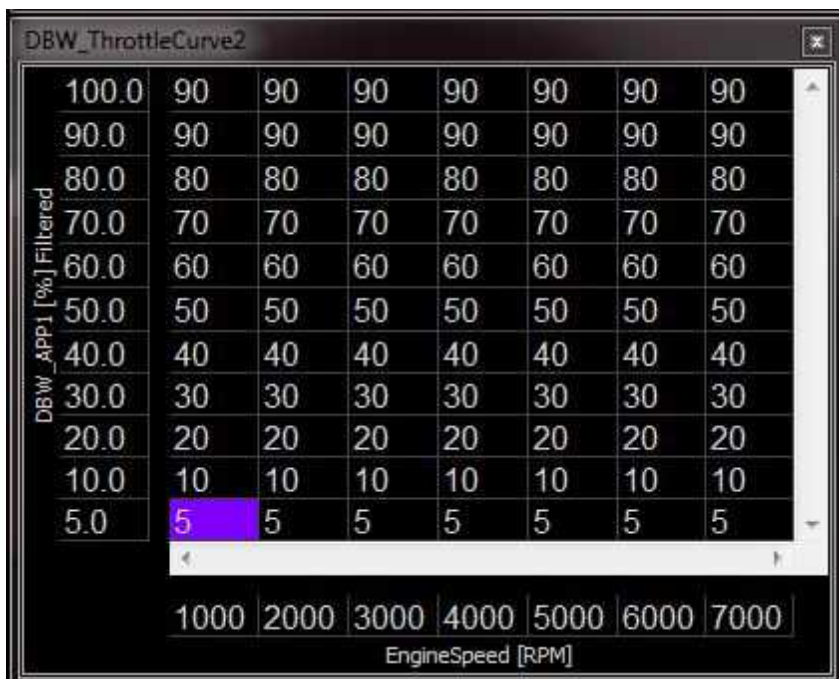

The screenshot shows a window titled "DBW_ThrottleCurve2" with a table of throttle position values. The y-axis is labeled "DBW_APP1 [%] Filtered" and ranges from 5.0 to 100.0 in increments of 10.0. The x-axis is labeled "EngineSpeed [RPM]" and has markers at 1000, 2000, 3000, 4000, 5000, 6000, and 7000. The table contains 8 columns of data. The value 5 is highlighted in the first column of the 5.0 row.

DBW_APP1 [%] Filtered	1000	2000	3000	4000	5000	6000	7000
100.0	90	90	90	90	90	90	90
90.0	90	90	90	90	90	90	90
80.0	80	80	80	80	80	80	80
70.0	70	70	70	70	70	70	70
60.0	60	60	60	60	60	60	60
50.0	50	50	50	50	50	50	50
40.0	40	40	40	40	40	40	40
30.0	30	30	30	30	30	30	30
20.0	20	20	20	20	20	20	20
10.0	10	10	10	10	10	10	10
5.0	5	5	5	5	5	5	5

Advanced Individual Cylinder Tuning

MAP [psi]	1000	1500	2000	2500	3000	3500	4000	4500	5000	5500	6000	6500	7000	7500	8000	8500	9000	9500	10000	105
13.1	0.0	0.0	0.0	0.0	0.0	0.0	0.0	0.0	0.0	0.0	0.0	0.0	0.0	0.0	0.0	0.0	0.0	0.0	0.0	0.0
11.6	0.0	0.0	0.0	0.0	0.0	0.0	0.0	0.0	0.0	0.0	0.0	0.0	0.0	0.0	0.0	0.0	0.0	0.0	0.0	0.0
10.2	0.0	0.0	0.0	0.0	0.0	0.0	0.0	0.0	0.0	0.0	0.0	0.0	0.0	0.0	0.0	0.0	0.0	0.0	0.0	0.0
8.7	0.0	0.0	0.0	0.0	0.0	0.0	0.0	0.0	0.0	0.0	0.0	0.0	0.0	0.0	0.0	0.0	0.0	0.0	0.0	0.0
7.3	0.0	0.0	0.0	0.0	0.0	0.0	0.0	0.0	0.0	0.0	0.0	0.0	0.0	0.0	0.0	0.0	0.0	0.0	0.0	0.0
5.8	0.0	0.0	0.0	0.0	0.0	0.0	0.0	0.0	0.0	0.0	0.0	0.0	0.0	0.0	0.0	0.0	0.0	0.0	0.0	0.0
4.4	0.0	0.0	0.0	0.0	0.0	0.0	0.0	0.0	0.0	0.0	0.0	0.0	0.0	0.0	0.0	0.0	0.0	0.0	0.0	0.0
2.9	0.0	0.0	0.0	0.0	0.0	0.0	0.0	0.0	0.0	0.0	0.0	0.0	0.0	0.0	0.0	0.0	0.0	0.0	0.0	0.0
1.5	0.0	0.0	0.0	0.0	0.0	0.0	0.0	0.0	0.0	0.0	0.0	0.0	0.0	0.0	0.0	0.0	0.0	0.0	0.0	0.0
0.0	0.0	0.0	0.0	0.0	0.0	0.0	0.0	0.0	0.0	0.0	0.0	0.0	0.0	0.0	0.0	0.0	0.0	0.0	0.0	0.0

For certain V8 racing engines, additional individual cylinder fuel trims have been added. They are higher resolution 2D tables that allow very precise trims to be applied vs RPM and manifold pressure. This feature is primarily intended for certain racing V8 engines that are required to maintain an intake manifold originally designed for use with carburetors. These trims are available for injectors 1-8. Recommend using individual cylinder lambda sensors to tune these tables. Note that these trims ADD to the simpler individual trims described in the [Fuel Trims](#) section. A value of 0.01 in this table will result in a +1.0% trim. A value of -0.01 in this table will result in a -1.0% trim.

Staged Injection Tuning

Utilizing a 2D table labeled StagedSplit [%], injector flow can be controlled between primary and secondary injectors. A value of 100% means all flow will go to the primary injectors while 0% means all flow will go to the secondary injectors. To calculate equal flow from both injectors, take the primary injector flow and divide it by the total injector flow (eg. primary injector = Injector Dynamics 1000, secondary injector = Injector Dynamics 2000; obtain even flow with $1000/(1000+2000) = .33333 = 33.33\%$. This is the percent of flow for primary injector to have the same flow as a larger secondary injector).

500	100	100	100	100	100	100	100	100	100	100
450	100	100	100	100	100	100	100	100	100	100
400	100	100	100	100	100	100	100	100	100	100
350	100	100	100	100	100	100	100	100	100	100
300	100	100	100	100	100	100	100	100	100	100
250	100	100	100	100	100	100	100	100	100	100
200	100	100	100	100	100	100	100	100	100	100
150	100	100	100	100	100	100	100	100	100	100
100	100	100	100	100	100	100	100	100	100	100
50	100	100	100	100	100	100	100	100	100	100
	1000	2000	3000	4000	5000	6000	7000	8000	9000	10000

StagedSwitch table

StagedSwitch table values of '0' will force staged injection calculations to use primary injectors only, default table values '1' will allow staged injection. This allows the user to override the staged injection activation using a switched input if desired.

0.000	0.000	0.000	0.000
0.000	0.100	0.200	0.300

DBW Custom Setup and Troubleshooting

Drive by wire is disabled by default until Drive By Wire Wizard is completed.

Additional PID controls can be found in [Wizard Setup -> DBW Tuning](#)

DBW_ThrottleCurve1:

Units: Engine Speed [RPM] vs DBW_APP1[%]Filtered vs Throttle %

Range: Min value = 0, Max value = 127.5

Map used for controlling throttle % based off analog APP1 input (C2-13 Analog 18 in Infinity 8/10/12)

DBW_ThrottleCurve2:

Units: Engine Speed [RPM] vs DBW_APP1[%]Filtered vs Throttle %

Range: Min value = 0, Max value = 127.5

Map used for controlling throttle % based off analog APP1 input (C2-13 Analog 18 in Infinity 8/10/12)

Note: Details on switching between throttle curves can be found at [Advanced Tuning -> Multi-Map Features](#) ²⁴¹

Tuning Tips and Troubleshooting:

Recommend that the initial DBW setup and tuning be done with the engine off and a battery charger connected in order to bring Battery Volts up to the normal voltage you might find when the engine is running, for instance something greater than 13V.

A 'DBW' tab is available. It contains useful data and plot windows to assist in tuning the DBW PIDs.

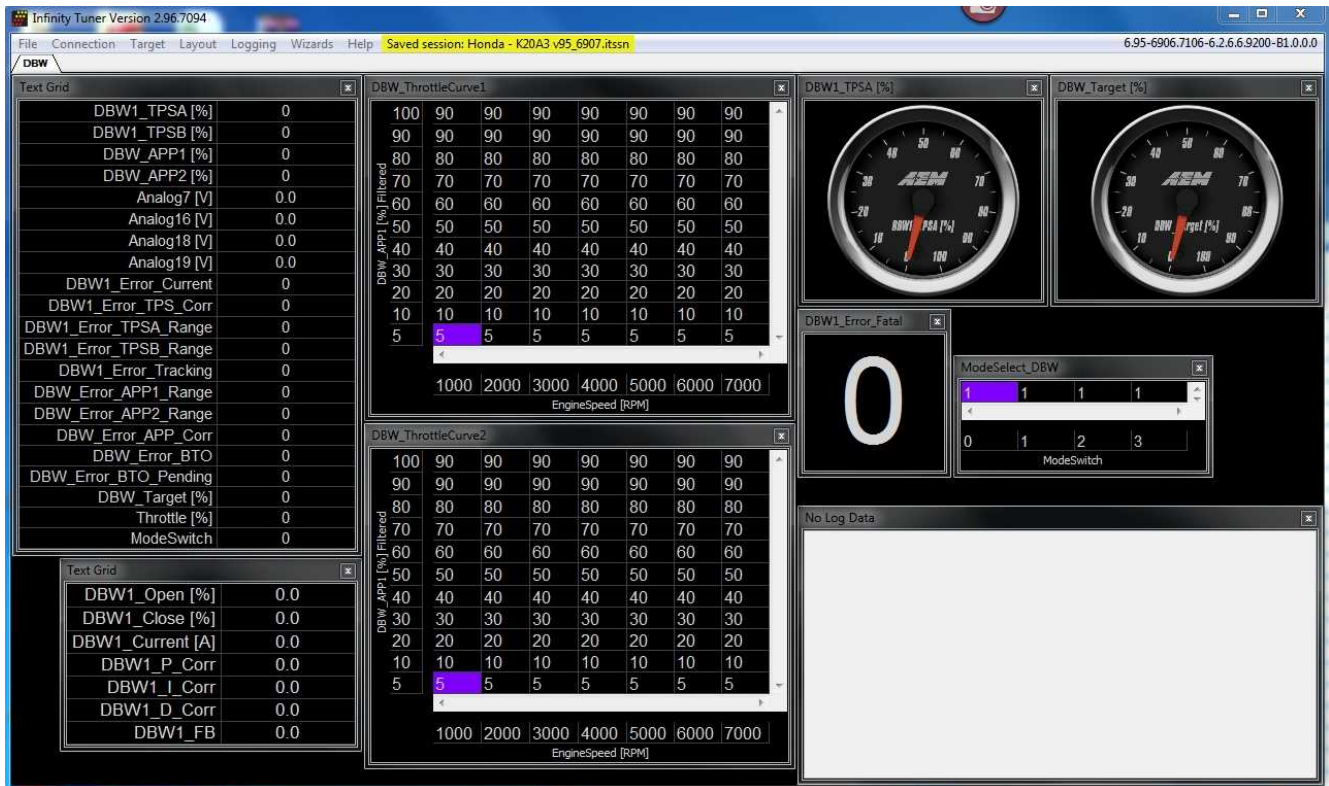

DBW1_Open [%] is the duty cycle being used to open the throttle motor, possible values are 0 to (+100)%

DBW1_Close [%] is the duty cycle used to close the throttle motor, possible values are (-100) to 0%

DBW1_Current [A] is a measured value, the ECU measures the amount of current that the throttle motor is drawing from the ECU

DBW1_Current_Avg (not shown above) is a calculated value, the ECU measures the amount of current that the throttle motor is drawing from the ECU. This value is smoothed out and filtered pretty heavily.

The center-right plot window shows the contribution of each of the P, I, and D gains... These are using the same scale as the DBW1_Open and DBW1_Close, so if DBW1_P_Corr is +35 that means the 'P' component of the PID feedback system is adding 35% duty cycle to the throttle motor output.

The lower-right plot window shows the DBW1_Target (desired value) vs DBW1_TPSA [%] (actual value). The PID

feedback loop is simply trying to make the actual value match the desired value.

Another tool that may help greatly is to change the DBW_Bias % table. This is the open-loop duty cycle starting point used to hit certain DBW Targets. Similar to the Idle Base table this is the first step before the DBW PID feedback kicks in. Try watching the DBW1_Open value when the DBW is doing a good job of making the throttle go to the target position, it's not a bad idea to set the DBW_Bias table to something near (but below) the duty cycle that hits the target.

The DBW_Bias table values that worked for some vehicles were between -20 and +50, depending on the DBW_Target. You may need negative effort to close the throttle against the spring at idle and positive effort to open the throttle against the spring at higher targets.

Raw signals to datalog:

Analog 7 [V] = DBW1_TPSA [%]

Analog 16 [V] = DBW1_TPSB [%]

Analog 18 [V] = DBW_APP1 [%]

Analog 19 [V] = DBW_APP2 [%]

DBW Error Detection

There is a text-grid near the lower-left side of the screen that includes various error flags. Here's a breakdown of what could trigger each error.

DBW1_Error_Current: triggered if DBW1_Current remains above 4A for more than 1.0 second. If you look through your logs, you'll notice DBW1_Current looks 'rough' so it's pretty unlikely this error will get triggered.

DBW1_Error_TPS_Corr: The ECU checks the correlation between the two position sensors on the electronic throttle. When the wizard calibrates the throttle, a relationship is observed and stored in the table 'DBW1_TPS_AB_Rel'. The error gets triggered if the value for 'DBW1_TPSB [%]' differs from the 'DBW1_TPS_AB_Rel' table value by more than 8. There is a plot window on the 'Page 3' page of the DBW layout that allows you to view these two values... note they would always be near each other, the difference between them should never be greater than 8. For the E46 BMW, it may be necessary to adjust the first two cells in the DBW1_TPS_AB_Rel table to prevent errors.

DBW1_Error_TPSA_Range: simple sensor error-checking. The DBW calibration wizard moves the throttle through its full range and then assumes the sensors will not exceed those min/max voltages by more than a certain amount (5-10%). The error gets triggered if the DBW1_TPSA voltage is exceeds the expected range.

DBW1_Error_TPSB_Range: (similar to DBW1_Error_TPSA_Range).

DBW1_Error Tracking: This gets triggered if the DBW1_Target_Error [%] is too high for too long. DBW1_Target_Error [%] is the difference between the target throttle and actual throttle (DBW1_TPSA). The definition of 'error too high' depends on the target throttle, but in general it's about 5-10% error allowed, for about 1 second.

DBW_Error_APP1_Range: (similar to DBW1_Error_TPSA_Range, but checking the min/max allowable voltages for the accelerator pedal sensor).

DBW_Error_APP2_Range: (similar to DBW1_Error_TPSA_Range, but checking the min/max allowable voltages for the accelerator pedal sensor).

DBW_Error_APP_Corr: (similar to DBW1_Error_TPS_Corr, but checking the correlation between the two Accelerator Pedal sensors).

DBW1_Error_Fatal: which gets triggered if any of these errors is active for more than 1 second. When DBW1_Error_Fatal is on, the ECU will stop driving the DBW motor and kill the injectors and coils.

Coil Dwell Tuning

The coil dwell is the time in which the control signal will charge the coil before the spark event. The image below shows a sample capture of a 4 cylinder engine setup.

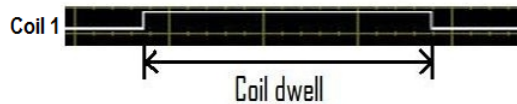
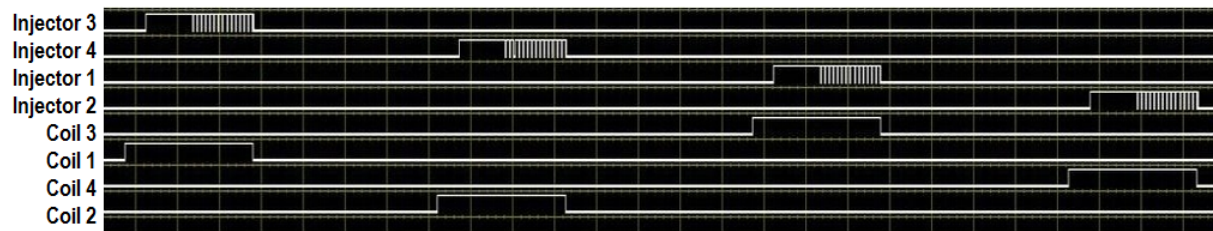

Coil dwell is configured in the Infinity Tuner Software using the following table. **WARNING! INCORRECT IGNITION DWELL SETTINGS CAN LEAD TO COIL OVERHEATING AND A POTENTIAL FIRE HAZARD. CONTACT YOUR IGNITION COIL MANUFACTURER FOR RECOMMENDED DWELL SETTINGS.**

CoilDwellMap

Units: kPA vs. Volts vs. mS

Description: This table sets the appropriate coil dwell at specific engine loads and battery voltage.

MAP [kPa]	8	9	10	11	12	13	14	15	16
400.0	5.00	5.00	5.00	5.00	4.00	3.50	3.00	3.00	3.00
300.0	5.00	5.00	5.00	5.00	4.00	3.50	3.00	3.00	3.00
200.0	5.00	5.00	5.00	5.00	4.00	3.50	3.00	3.00	3.00
100.0	5.00	5.00	5.00	5.00	4.00	3.50	3.00	3.00	3.00
50.0	5.00	5.00	5.00	5.00	4.00	3.50	3.00	3.00	3.00
20.0	5.00	5.00	5.00	5.00	4.00	3.50	3.00	3.00	3.00

CoilDwell

Units: mS

Description: This channel represents the current coil dwell time after all lookup tables have been calculated.



VR PWMDuty [%] Tables



A variable voltage threshold for VR inputs is set by editing these two tables. The channel is a % duty and corresponds to threshold voltages as shown in the table below. We recommend leaving the RPM breakpoints as set from AEM and as shown in the examples.

VR_Pwm Duty [%]	Trigger Threshold [V]
20	0.08
30	0.21
40	0.40
50	0.58
60	0.78
70	1.10
80	1.48
90	2.06
95	2.38
100	2.76

The table below describes which VR_PwmDuty table is used for each VR input.

Hardware Platform	Harness Pin	Hardware Ref.	VR PWMDuty [%] Table
Infinity-8/10/12	C1-45/C1-46	Crankshaft Position Sensor VR+_In	VR_PwmDuty [%]
		Crankshaft Position Sensor	

Hardware Platform	Harness Pin	Hardware Ref.	VR PWM Duty [%] Table
		VR-_In	
Infinity-8/10/12	C1-47/C1-48	Camshaft Position Sensor1 VR-_In Camshaft Position Sensor1 VR+_In	VR_PwmDuty [%]
Infinity-8/10/12	C1-49/C1-50	VR+_In_2 VR-_In_2	VR1_PwmDuty [%]
Infinity-8/10/12	C1-51/C1-52	VR-_In_3 VR+_In_3	VR1_PwmDuty [%]
Infinity-8/10/12	C2-25/C2-26	VR+_In_5 VR-_In_5	VR1_PwmDuty [%]
Infinity-8/10/12	C2-27/C2-28	VR-_In_4 VR+_In_4	VR1_PwmDuty [%]
Infinity-6/8H	C1-17/C1-18	Crankshaft Position Sensor VR+_In Crankshaft Position Sensor VR-_In	VR_PwmDuty [%]
Infinity-6/8H	C1-19/C1-20	Camshaft Position Sensor1 VR-_In Camshaft Position Sensor1 VR+_In	VR_PwmDuty [%]
Infinity-6/8H	C1-54/C1-55	VR+_In_2 VR-_In_2	VR1_PwmDuty [%]
Infinity-6/8H	C1-56/C1-57	VR-_In_3 VR+_In_3	VR1_PwmDuty [%]

Cam/Crank Noise Cancellation Feature

Calculating Noise Cancellation Values for Specific Timing Patterns

Every timing pattern will have unique tooth widths for both the Cam and Crank signals. Additionally, Engine Speed (RPM) determines the time duration of each tooth width. Therefore there are several considerations to take into account when calculating the desired Noise Cancellation values.

The shortest duration between edges is the first value to determine by examining the trigger wheels or signal outputs from the Crank Position Sensor and Cam Position Sensor(s). This means that either the shortest tooth or the shortest gap between teeth needs to be used in the calculation (whichever is shorter in duration (degrees). What is important is the minimum time between edge transitions, either high to low, or low to high within the entire trigger wheel. For a 60-2 even spaced trigger wheel, the minimum tooth duration is 6 degrees (360/60). However the

tooth is actually high for 3 degrees and low for 3 degrees. Therefore the useful value here is 3 degrees. This value will be used in Column D in the table below, which uses a 60-2 trigger wheel as an example.

The second important variable specific to each engine is the maximum Engine Speed (RPM) that the engine will spin to. This is because the duration of each degree of trigger wheel (in microseconds) will be reduced as the engine spins to a higher RPM. The maximum desired RPM needs to be used as the deciding factor, and can be seen in Cell A12 in the table below.

Use the table below to calculate the desired Noise Cancellation value for the Crank Position Sensor for a 60-2 trigger wheel. The RPM values in Column A represent maximum desired RPM. Assume for this example that you want to spin the engine to 9500 RPM. Therefore you will use Row 12 to calculate the Noise Cancellation value.

From left to right, the RPM is used to calculate degrees per millisecond, the milliseconds per degree, then microseconds between edge transitions, and finally Noise Cancellation values based on 3.2us per increment. At 9500 RPM and 3 degrees between edge transitions, each transition will happen in 52.6 microseconds. Therefore you can have a maximum Noise Cancellation value of 16 ($16 * 3.2\text{us} = 51.2\text{us}$).

	A	B	C	D	E	F	G
1		= $A * 360 / (60 * 1000)$	= $1 / B$	Ex: 60-2 (3 deg high/3 deg low)	= $C * D * 1000$	Determined by SH chip	= $E / 3.2$
2	200 RPM	1.2 degrees/ms	0.8333 ms/degree	3 degrees	2500.0 us (microsecond)	3.2 us/NC point	781 NC max value
3	500	3.0	0.3333	3	1000.0	3.2	313
4	1500	9.0	0.1111	3	333.3	3.2	104
5	2500	15.0	0.0667	3	200.0	3.2	63
6	3500	21.0	0.0476	3	142.9	3.2	45
7	4500	27.0	0.0370	3	111.1	3.2	35
8	5500	33.0	0.0303	3	90.9	3.2	28
9	6500	39.0	0.0256	3	76.9	3.2	24
10	7500	45.0	0.0222	3	66.7	3.2	21
11	8500	51.0	0.0196	3	58.8	3.2	18
12	9500	57.0	0.0175	3	52.6	3.2	16

Another important consideration when determining Noise Cancellation values is that the values calculated from the table above assume a noise-free signal. More specifically, if noise occurs at some location in between edge transitions, the effective tooth duration is split up by the noise. If a single noise impulse occurs 1.5 degrees into a 3-degree tooth duration, then you will effectively have two 1.5-degree teeth widths. Therefore the calculation above is only a guideline and should not be used at the maximum limit. The actual Noise Cancellation value may have to be 2-3 times smaller than the maximum allowed value to compensate for random noise injected into the signal. To understand this idea more completely, refer back to the figures above.

CAN (AEMNet)

AEMnet
v150324

CAN
2.0

Unless otherwise specified all
messages are;

29 bit, 500 kBit/sec, 8 data bytes per
message

Multi-byte data is packed big endian (Motorola format, most significant byte
transmitted first)

Bits numbered MSB first, with the
MSB = bit7, LSB = bit0

Message ID: 0x01F0A000

AEM V2 & EMS-4 (30-
Sources: 6XXX)

Infinity EMS (30-71XX)

20ms continuous (50hz) SI Units (C / kPa / kph / Lambda)

Byte	Bit	Label	Data Type	Scaling	Offset	Range
0-1		Engine Speed	16 bit unsigned	0.39063 rpm/bit	0	0 to 25,599.94 RPM
2-3		Engine Load (Deprecated 2014) Use "MAP" in 0x01F0A004 Instead	16 bit unsigned	0.002612304811 57781	0	0 to 99.998 %
4-5		Throttle	16 bit unsigned	0.0015259 %/bit	0	0 to 99.998 %
6		Intake Air Temp	8 bit signed, 2's comp	1 Deg C/bit	0	-128 to 127 C
7		Coolant Temp	8 bit signed, 2's comp	1 Deg C/bit	0	-128 to 127 C

Message ID: 0x01F0A001

AEM V2 & EMS-4 (30-
Sources: 6XXX)

20ms continuous (50hz) SI Units (C / kPa / kph / Lambda)

Byte	Bit	Label	Data Type	Scaling	Offset	Range
0-1		ADCR11	16 bit unsigned	0.00007782 V/ bit	0	0 to 5.0999 V
2-3		ADCR13	16 bit unsigned	0.00007782 V/ bit	0	0 to 5.0999 V

4-5		ADCR14	16 bit unsigned	0.00007782 V/ bit	0	0 to 5.0999 V
6-7		ADCR17	16 bit unsigned	0.00007782 V/ bit	0	0 to 5.0999 V

Message ID: 0x01F0A002

**AEM V2 & EMS-4 (30-
Sources: 6XXX)**

20ms continuous (50hz) SI Units (C / kPa / kph / Lambda)

Byte	Bit	Label	Data Type	Scaling	Offset	Range
0-1		ADCR18	16 bit unsigned	0.00007782 V/ bit	0	0 to 5.0999 V
2-3		ADCR15	16 bit unsigned	0.00007782 V/ bit	0	0 to 5.0999 V
4-5		ADCR16	16 bit unsigned	0.00007782 V/ bit	0	0 to 5.0999 V
6-7		ADCR08	16 bit unsigned	0.000326 V/bit	0	0 to 21.3644 V

Message ID: 0x01F0A003

**AEM V2 & EMS-4 (30-
Sources: 6XXX)**

Infinity EMS (30-71XX)

20ms continuous (50hz) SI Units (C / kPa / kph / Lambda)

Byte	Bit	Label	Data Type	Scaling	Offset	Range
0		Lambda #1	8 bit unsigned	0.00390625 Lambda/bit	0.5	0.5 to 1.496 Lambda
1		Lambda #2	8 bit unsigned	0.00390625 Lambda/bit	0.5	0.5 to 1.496 Lambda
2-3		Vehicle Speed	16 bit unsigned	0.0062865 kph/ bit	0	0 to 411.986 km/h
4		Gear Calculated	8 bit unsigned	1	0	0 to 255
5		Ign Timing	8 bit unsigned	.35156 Deg/bit	-17	-17 to 72.65 Deg
6-7		Battery Volts	16 bit unsigned	0.0002455 V/bit	0	0 to 16.089 Volts

Message ID: 0x01F0A004

**Infinity EMS (30-71XX) V96 May 2015 and
Sources: Later**

20ms continuous (50hz) SI Units (C / kPa / kph / Lambda)

Byte	Bit	Label	Data Type	Scaling	Offset	Range
0-1		MAP	16 bit unsigned	0.1 kPa/bit	0	0 to 6,553.5 kPa
2		VE	8 bit unsigned	1 %/bit	0	0 to 255 %
3		FuelPressure	8 bit unsigned	0.580151 PSig/bit	0	0 to 147.939 PSig
4		OilPressure	8 bit unsigned	0.580151 PSig/bit	0	0 to 147.939 PSig
5		LambdaTarget	8 bit unsigned	0.00390625 Lambda/bit	0.5	0.5 to 1.496 Lambda
6	0 (lsb)	FuelPump	Boolean	0 = false, 1 = true	0	0/1
	1	Fan 1	Boolean	0 = false, 1 = true	0	0/1
	2	Fan 2	Boolean	0 = false, 1 = true	0	0/1
	3	N2O Active	Boolean	0 = false, 1 = true	0	0/1
	4	O2FB Active	Boolean	0 = false, 1 = true	0	0/1
	5	EngineProtectOut	Boolean	0 = false, 1 = true	0	0/1
	6	MILOutput	Boolean	0 = false, 1 = true	0	0/1
	7 (msb)	Lean Protect	Boolean	0 = false, 1 = true	0	0/1
7	0 (lsb)	Oil Press Protect	Boolean	0 = false, 1 = true	0	0/1
	1	2 Step Fuel	Boolean	0 = false, 1 = true	0	0/1
	2	2 Step Spark	Boolean	0 = false, 1 = true	0	0/1
	3	Sync State	Boolean	0 = false, 1 = true	0	0/1
	4	A/C On	Boolean	0 = false, 1 = true	0	0/1
	5	BoostCut	Boolean	0 = false, 1 = true	0	0/1
	6	----	Boolean	----	----	----
	7	----	Boolean	----	----	----

(msb)

Message ID: 0x01F0A005

**Infinity EMS (30-71XX) V96 May 2015 and
Sources: Later**

20ms continuous (50hz) SI Units (C / kPa / kph / Lambda)

Byte	Bit	Label	Data Type	Scaling	Offset	Range
0-1		LaunchRampTime [ms]	16 bit unsigned	10 mS/bit	0	0 to 655,350 mS
2-3		MassAirflow [gms/s]	16 bit unsigned	.05 [gms/s] / bit	0	0 to 3,276.75 gms/s
4-5		MassAirflow [gms/rev]	16 bit unsigned	.0005 [gms/rev] / bit	0	0 to 32.7675 gms/rev
6		----	----	----	----	----
7	0 (lsb)	Brake Sw	Boolean	0 = false, 1 = true	0	0/1
	1	Clutch Sw	Boolean	0 = false, 1 = true	0	0/1
	2	Shift Sw	Boolean	0 = false, 1 = true	0	0/1
	3	Staged Sw	Boolean	0 = false, 1 = true	0	0/1
	4	----	Boolean	----	----	----
	5	----	Boolean	----	----	----
	6	----	Boolean	----	----	----
	7 (msb)	----	Boolean	----	----	----

Message ID: 0x01F0A006

**Infinity EMS (30-71XX) V96 May 2015 and
Sources: Later**

40ms continuous (25hz) SI Units (C / kPa / kph / Lambda)

Byte	Bit	Label	Data Type	Scaling	Offset	Range
0		Inj1Pulse	8 bit unsigned	0.1 mS/bit	0	0 to 25.5 mS
1		Inj1LambdaFB	8 bit unsigned	0.5 %/bit	-64.00	-64 to 63.5%
2		PrimaryInjDuty [%]	8 bit unsigned	0.392157 %/bit	0	0 to 100 %
3		Mode Sw	8 bit unsigned	1 /bit	0	0 - 255

4		Water Pressure	8 bit unsigned	0.580151 PSig/ bit	0	0 to 147.939 PSig
5		Crankcase Pressure	8 bit unsigned	1 kPa/bit	0	0 to 255 kPa
6-7		Est Torque	16 bit unsigned	0.1 Nm/bit	- 3276.8	=3276.8 to 3276.8 Nm

Message ID: 0x01F0A007

Infinity EMS (30-71XX) V96 May 2015 and

Sources: Later

40ms continuous (25hz) SI Units (C / kPa / kph / Lambda)

Byte	Bit	Label	Data Type	Scaling	Offset	Range
0		InjectorProbability [%]	8 bit unsigned	0.392157 %/bit	0	0 to 100 %
1		SparkProbability [%]	8 bit unsigned	0.392157 %/bit	0	0 to 100 %
2		LambdaTrim_Knock	8 bit unsigned	0.001 Lambda/ bit	0	0 to 0.255 Lambda
3		Baro Press	8 bit unsigned	0.25 kPa/bit	50	50 to 113.75 kPa
4		FlexContent	8 bit unsigned	0.392157 %/bit	0	0 to 100 %
5		Airbox Temp	8 bit unsigned	1 Deg C/bit	-50.00	-50 to 205 C
6		Oil Temp	8 bit unsigned	1 Deg C/bit	-50.00	-50 to 205 C
7	0 (lsb)	LaunchTimerArmed	Boolean	0 = false, 1 = true	0	0/1
	1	Logging Active	Boolean	0 = false, 1 = true	0	0/1
	2	ModeSelect_Ign	2 bit unsigned	####00## = Mode 1, ####01## = Mode 2 ####10## = Mode 3, ####11## = Mode 4		
	3					
	4	ModeSelect_Lambda	2 bit unsigned	##00#### = Mode 1, ##01#### = Mode 2 ##10#### = Mode 3, ##11#### = Mode 4		
	5					
	6	ModeSelect_DBW	1 bit unsigned	#0##### = Mode 1, #1##### = Mode 2		
7 (msb)	VTEC	Boolean	0 = false, 1 = true	0	0/1	

Message ID: 0x01F0A008

Infinity EMS (30-71XX)

Sources: V96 May 2015 and Later

200ms continuous (5hz) SI Units (C / kPa / kph / Lambda)

Byte	Bit	Label	Data Type	Scaling	Offset	Range
------	-----	-------	-----------	---------	--------	-------

0		Trans Temp	8 bit unsigned	1 Deg C/bit	-50.00	-50 to 205 C
1-2		SparkCut [RPM]	16 bit unsigned	0.39063 rpm/bit	0	0 to 25,599.94 RPM
3-4		FuelCut [RPM]	16 bit unsigned	0.39063 rpm/bit	0	0 to 25,599.94 RPM
5		2StepTargetFuel [RPM]	8 bit unsigned	100 rpm/bit	0	0 to 25,500 RPM
6		2StepTargetSpark [RPM]	8 bit unsigned	100 rpm/bit	0	0 to 25,500 RPM
7	0 (lsb)	ErrorThrottle	Boolean	0 = false, 1 = true	0	0/1
	1	ErrorCoolantTemp	Boolean	0 = false, 1 = true	0	0/1
	2	ErrorFuelPressure	Boolean	0 = false, 1 = true	0	0/1
	3	ErrorOilPressure	Boolean	0 = false, 1 = true	0	0/1
	4	ErrorEBP	Boolean	0 = false, 1 = true	0	0/1
	5	ErrorMAP	Boolean	0 = false, 1 = true	0	0/1
	6	ErrorAirTemp	Boolean	0 = false, 1 = true	0	0/1
	7 (msb)	ErrorBaro	Boolean	0 = false, 1 = true	0	0/1

Message ID: 0x01F0A00A

Infinity EMS (30-71XX) V96 May 2015 and Later, with VVTi control Sources: enabled

40ms continuous (25hz) SI Units (C / kPa / kph / Lambda)

Byte	Bit	Label	Data Type	Scaling	Offset	Range
0		VVC1A_Cam_Timing	8 bit unsigned	0.5 deg/bit	-50	-50 to 77.5 deg
1		VVC2A_Cam_Timing	8 bit unsigned	0.5 deg/bit	-50	-50 to 77.5 deg
2		VVC1B_Cam_Timing	8 bit unsigned	0.5 deg/bit	-50	-50 to 77.5 deg
3		VVC2B_Cam_Timing	8 bit unsigned	0.5 deg/bit	-50	-50 to 77.5 deg
4		VVC1 Target [deg]	8 bit unsigned	0.5 deg/bit	-50	-50 to 77.5 deg
5		VVC2 Target [deg]	8 bit unsigned	0.5 deg/bit	-50	-50 to 77.5 deg
6		----	----	----	----	----
7		----	----	----	----	----

Message ID: 0x01F0A00B

**Infinity EMS (30-71XX) V96 May 2015 and Later, with Boost control
Sources: enabled**

40ms continuous (25hz) SI Units (C / kPa / kph / Lambda)

Byte	Bit	Label	Data Type	Scaling	Offset	Range
0-1		BoostTarget	16 bit unsigned	0.1 kPa/bit	0	0 to 6,553.5 kPa
2-3		ChargeOutPress	16 bit unsigned	0.1 kPa/bit	0	0 to 6,553.5 kPa
4		BoostControl [%]	8 bit unsigned	0.392157 %/bit	0	0 to 100 %
5		BoostFB_PID [%]	8 bit unsigned	0.392157 %/bit	0	0 to 100 %
6		ChargeOutTemp	8 bit unsigned	1 Deg C/bit	-50.00	-50 to 205 C
7		TurboSpeed [RPM]	8 bit unsigned	500 rpm/bit	0	0 to 127,500 RPM

Message ID: 0x01F0A00D

**Infinity EMS (30-71XX) V96 May 2015 and Later, with DBW control
Sources: enabled**

40ms continuous (25hz) SI Units (C / kPa / kph / Lambda)

Byte	Bit	Label	Data Type	Scaling	Offset	Range
0		DBW_APP1	8 bit unsigned	0.392157 %/bit	0	0 to 100 %
1		DBW_Target	8 bit unsigned	0.392157 %/bit	0	0 to 100 %
2		DBW1_TPSA	8 bit unsigned	0.392157 %/bit	0	0 to 100 %
3		DBW2_TPSA	8 bit unsigned	0.392157 %/bit	0	0 to 100 %
4		----	----	----	----	----
5	0 (lsb)	DBW_Error_APP_Cor_r	Boolean	0 = false, 1 = true	0	0/1
	1	DBW_Error_APP1_Ra_nge	Boolean	0 = false, 1 = true	0	0/1
	2	DBW_Error_APP2_Ra_nge	Boolean	0 = false, 1 = true	0	0/1
	3	DBW_Error_BTO	Boolean	0 = false, 1 = true	0	0/1
	4	----	Boolean	----	----	----
	5	----	Boolean	----	----	----
	6	----	Boolean	----	----	----

	7 (msb)	----	Boolean	----	----	----
6	0 (lsb)	DBW1_Error_Fatal	Boolean	0 = false, 1 = true	0	0/1
	1	DBW1_Error_TPSA_Range	Boolean	0 = false, 1 = true	0	0/1
	2	DBW1_Error_TPSB_Range	Boolean	0 = false, 1 = true	0	0/1
	3	DBW1_Error_Tracking	Boolean	0 = false, 1 = true	0	0/1
	4	DBW1_Error_Current	Boolean	0 = false, 1 = true	0	0/1
	5	DBW1_Error_TPS_Corr	Boolean	0 = false, 1 = true	0	0/1
	6	----	Boolean	----	----	----
	7 (msb)	----	Boolean	----	----	----
7	0 (lsb)	DBW2_Error_Fatal	Boolean	0 = false, 1 = true	0	0/1
	1	DBW2_Error_TPSA_Range	Boolean	0 = false, 1 = true	0	0/1
	2	DBW2_Error_TPSB_Range	Boolean	0 = false, 1 = true	0	0/1
	3	DBW2_Error_Tracking	Boolean	0 = false, 1 = true	0	0/1
	4	DBW2_Error_Current	Boolean	0 = false, 1 = true	0	0/1
	5	DBW2_Error_TPS_Corr	Boolean	0 = false, 1 = true	0	0/1
	6	----	Boolean	----	----	----
	7 (msb)	----	Boolean	----	----	----

Message ID: 0x01F0A010

Infinity EMS (30-71XX) V96 May 2015 and Later, with Traction Sources: control enabled

20ms continuous (50hz) SI Units (C / kPa / kph / Lambda)

Byte	Bit	Label	Data Type	Scaling	Offset	Range
0		TC_FuelCut [%]	8 bit unsigned	0.392157 %/bit	0	0 to 100 %

1		TC_SparkCut [%]	8 bit unsigned	0.392157 %/bit	0	0 to 100 %
2		TC_Retard [degBTDC]	8 bit unsigned	0.25 deg/bit	0	0 to 63.75 deg
3		TC_TqReduceDBW [%]	8 bit unsigned	0.392157 %/bit	0	0 to 100 %
4		TC_Mode_Sw	8 bit unsigned	1 /bit	0	0 - 255
5		3StepTargetFuel [RPM]	8 bit unsigned	100 rpm/bit	0	0 to 25,500 RPM
6		3StepTargetSpark [RPM]	8 bit unsigned	100 rpm/bit	0	0 to 25,500 RPM
7	0 (lsb)	3 Step Fuel	Boolean	0 = false, 1 = true	0	0/1
	1	3 Step Spark	Boolean	0 = false, 1 = true	0	0/1
	2	3 Step Sw	Boolean	0 = false, 1 = true	0	0/1
	3	----	Boolean	0 = false, 1 = true	0	0/1
	4	----	Boolean	0 = false, 1 = true	0	0/1
	5	----	Boolean	0 = false, 1 = true	0	0/1
	6	----	Boolean	0 = false, 1 = true	0	0/1
	7 (msb)	----	Boolean	0 = false, 1 = true	0	0/1

Message ID: 0x01F0A011

Infinity EMS (30-71XX) V96 May 2015 and Later, with Traction

Sources: control enabled

20ms continuous (50hz) SI Units (C / kPa / kph / Lambda)

Byte	Bit	Label	Data Type	Scaling	Offset	Range
0-1		DLWheelSpeed	16 bit unsigned	0.02 kph/bit	0	0 to 1310.7 km/h
2-3		DRWheelSpeed	16 bit unsigned	0.02 kph/bit	0	0 to 1310.7 km/h
4-5		NLWheelSpeed	16 bit unsigned	0.02 kph/bit	0	0 to 1310.7 km/h
6-7		NRWheelSpeed	16 bit unsigned	0.02 kph/bit	0	0 to 1310.7 km/h

Message ID: 0x01F0A012**Infinity EMS (30-71XX) V96 May 2015 and Later, with Traction****Sources: control enabled****20ms continuous (50hz) SI Units (C / kPa / kph / Lambda)**

Byte	Bit	Label	Data Type	Scaling	Offset	Range
0-1		TC_SlipTarget	16 bit unsigned	0.02 kph/bit	0	0 to 1310.7 km/h
2-3		TC_SlipMeasured	16 bit unsigned	0.02 kph/bit	0	0 to 1310.7 km/h
4-5		TC_TqReduceReq	16 bit unsigned	0.25/bit	0	0 to 16,383.75
6		----	----	----	----	----
7		----	----	----	----	----

Message ID: 0x01F0A020**Infinity EMS (30-71XX) V96 May 2015 and Later, with Knock****Sources: control enabled****20ms continuous (50hz) SI Units (C / kPa / kph / Lambda)**

Byte	Bit	Label	Data Type	Scaling	Offset	Range
0		KnockFB_Cyl1	8 bit unsigned	- 0.1 degree/bit	0	0 to -25.5 deg
1		KnockFB_Cyl2	8 bit unsigned	- 0.1 degree/bit	0	0 to -25.5 deg
2		KnockFB_Cyl3	8 bit unsigned	- 0.1 degree/bit	0	0 to -25.5 deg
3		KnockFB_Cyl4	8 bit unsigned	- 0.1 degree/bit	0	0 to -25.5 deg
4		KnockFB_Cyl5	8 bit unsigned	- 0.1 degree/bit	0	0 to -25.5 deg
5		KnockFB_Cyl6	8 bit unsigned	- 0.1 degree/bit	0	0 to -25.5 deg
6		KnockFB_Cyl7	8 bit unsigned	- 0.1 degree/bit	0	0 to -25.5 deg
7		KnockFB_Cyl8	8 bit unsigned	- 0.1 degree/bit	0	0 to -25.5 deg

Message ID: 0x01F0A021**Infinity EMS (30-71XX) V96 May 2015 and Later, with Extended****Sources: Knock control enabled****20ms continuous (50hz) SI Units (C / kPa / kph / Lambda)**

Byte	Bit	Label	Data Type	Scaling	Offset	Range
0		KnockFB_Cyl9	8 bit unsigned	- 0.1 degree/bit	0	0 to -25.5 deg
1		KnockFB_Cyl10	8 bit unsigned	- 0.1 degree/bit	0	0 to -25.5 deg
2		----	----	----	----	----

3		----	----	----	----	----
4		----	----	----	----	----
5		----	----	----	----	----
6		----	----	----	----	----
7		----	----	----	----	----

4 Channel Wideband UEGO Controller Setup

Infinity Supports 4 channel UEGO CAN input for logging purposes. Modes must be properly set up and if designated cylinders overlap, jittery values will be present in any overlapping cylinder sensor. Description of different modes are as follows:

Mode 1: Cylinders 1, 2, 3, 4

Mode 2: Cylinders 5, 6, 7, 8

Mode 3: Cylinders 1, 3, 5, 7

Mode 4: Cylinders 2, 4, 6, 8

Mode 5: Cylinders 9, 10, 11, 12

Mode 6: Cylinders 1, 2, 3

Mode 7: Cylinders 4, 5, 6

*NOTE: Proper use of UEGO modes is vital for ensuring data is captured correctly. See 4ch UEGO manual to configure modes or verify operating mode of controller.

A, B, and C relate to specific UEGO controllers

A refers to a controller in mode 1, 3, or 6

B refers to a controller in mode 2, 4, or 7

C refers to a controller in mode 5

UEGO Cyl 1-12:

Units: Lambda

Range: 0-6.5535

Displays current lambda value for each individual cylinder. If value is unstable, verify 4 channel UEGO does not have overlapping channels.

UEGO EBP A, B, C:

Units: psig

Range: 0-655.35

Displays Exhaust Back Pressure captured from specified controller

Diagnostics:

UEGO Error:

Has information regarding individual cylinders such as: Ready, Heater Open Error, VM Error, UN Error, IP Error, Heater Time-Out Error, Heater Short Error, and Overtemp Error.

UEGO EBP Status A, B, C:

Displays information about controller and EBP sensor such as low voltage for UEGO controller and EBP sensor, sensor ready status, and if sensor is detected or not.

UEGO Mode A, B, C:

Shows operating mode of UEGO controller, if using multiple controller and there are duplicate numbers, please refer to 4ch UEGO controller manual to adjust mode to avoid overlapping and properly monitor all cylinders.

UEGO Sensor Heating A, B, C:

Displays values representing sensor heating per cylinder from associated mode. (i.e., UEGO Sensor Heating A, will show a value of 15 for cylinders 1, 2, 3, 4 if controller is set to mode 1 and all sensors are ready.)

EFI Components

Spark Plugs

Spark plug selection affects engine performance. On forced induction engines, it is critical that the proper heat range and gap is used. Heat range refers to the ability of the spark plug to conduct heat away from the electrode to the engine. A plug that has high thermal conductivity has a short insulator that comes in contact with a large portion of the metallic plug shell. This large area allows the combustion heat to be carried through the plug shell to the cooling jacket of the cylinder head. In the case of a hot plug, the insulator is recessed deeply into the plug shell with minimal contact to the shell. The plug has low thermal conductivity due to the lack of contact with the shell. The nose of the insulator should operate at between 400–850 degrees C. Temperatures above 400 degrees C are desirable because at higher temperatures deposits from carbon, lead or soot are burnt off. Temperatures of 850 degrees C and over should not be exceeded because this is typically the point where detonation or auto ignition can occur. Lower heat range plugs have a higher resistance to auto ignition while higher heat range plugs have less tendency to foul.

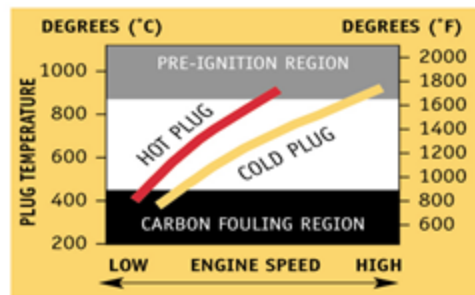

TEMPERATURE CURVES OF HOT AND COLD PLUGS

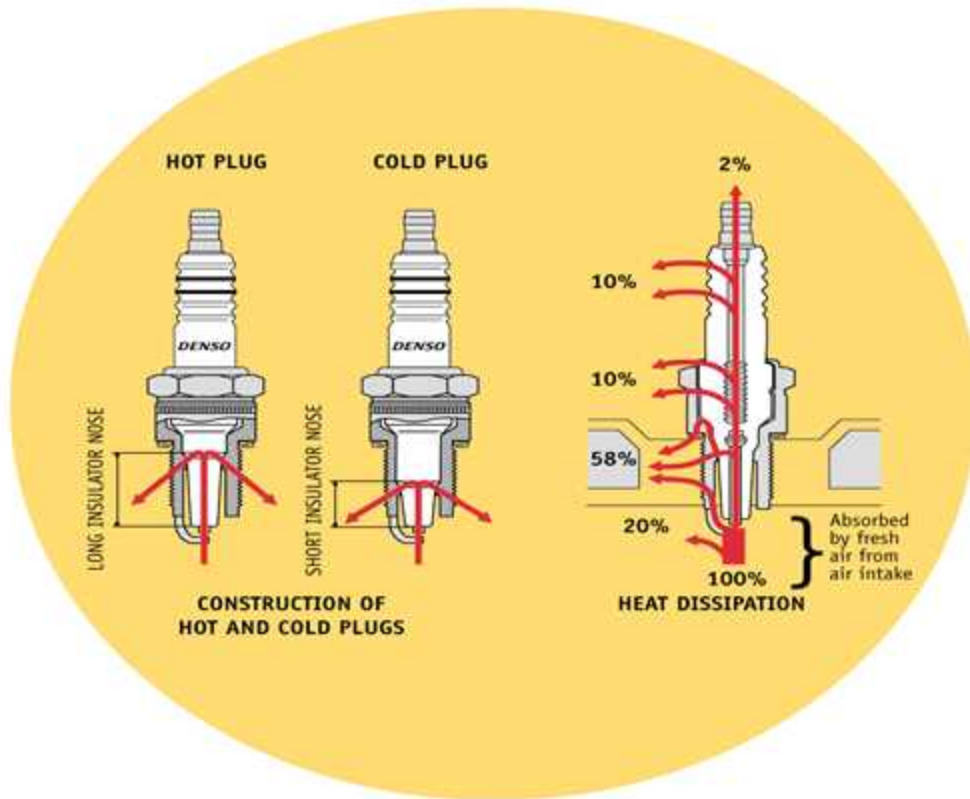

The spark plug gap on forced induction engines should be reduced REGARDLESS of the type of ignition system. We have read many instruction manuals for aftermarket ignition systems that recommend that the plug gap be opened up for better flame propagation. Although this recommendation may have had some merit when vehicles had carburetors, it does not apply to modern engines with electronic engine management systems. The smaller gap on forced-induction engines requires less spark energy to arc across the ground and the electrode and has a lesser tendency to misfire under the extreme pressures of a racing engine combustion chamber. Also there are spark plugs made with exotic fine wire highly conductive center electrodes that require less energy to fire such as the Denso Iridium that are well suited to racing conditions. The following is a chart of gap sizes for various engines on gasoline:

Naturally Aspirated up to 11.0:1 CR:	1.1mm (.044")
Naturally Aspirated 11.0:1 to 14.0:	0.8mm (.032")
Forced Induction to 20-PSI:	0.7mm (.028")
Forced Induction to 40-PSI:	0.6mm (.022")



The color or condition of the spark plug is a general indicator of how rich or lean the engine is running and also if the engine is exhibiting signs of detonation if it is not audible. This is a plug color chart (supplied courtesy of Denso) of plug conditions.

Detonation and Pre ignition

It is important to understand the mechanisms that cause knocking and pre ignition to set up an ignition map that is suitable for the engine. Auto ignition, also known as knocking, pinging, or detonation, is generally caused by improper combustion in an engine. An internal combustion engine runs properly when the spark-initiated combustion wave expands rapidly but smoothly throughout the combustion chamber. Combustion knock is caused by spontaneous ignition in the hot unburned portion of the fuel mixture (typically referred to as end gas) in the combustion chamber. The remaining charge portion is compressed first by the upward piston movement and then by the moving flame front. Knocking is the almost instantaneous ignition of part of the remaining mixture. This mixture auto ignites because the rapidly rising pressure and temperature caused by the piston movement and the expanding gas from the flame front are sufficient to ignite the remaining gasses. To illustrate the loads imposed on the engine components by knocking, note that normal combustion speeds are about 12-25 m.s⁻¹ while knocking combustion speeds may be as high as 250–300 m.s⁻¹.

The next illustration depicts the difference between a normal and abnormal combustion process.

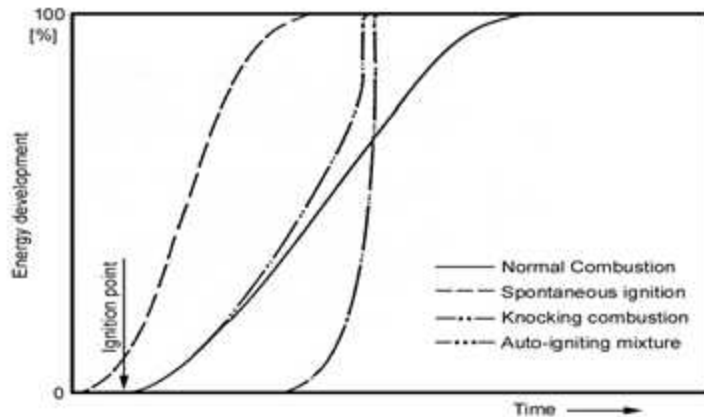

If the gasoline-air mixture auto-ignites somewhere in the cylinder (other than at the spark plug) just after spark ignition, the auto-ignition combustion wave can collide with the spark-initiated combustion wave, causing the vibration we hear as a knock or ping. Depending on its intensity, knocking combustion may range from barely audible “pinging” to a rather violent thumping. The point at which the knocking becomes damaging to the engine is dependent on the components used in the engine. If sustained knocking occurs, then the pistons may be damaged. When knocking reaches a violent thump, engine operation should be ceased or at minimum the load and temperature reduced to prevent engine damage. Light knocking that happens during acceleration is less harmful and may not damage the engine. Knocking tendency is increased by the following design or operational characteristics:

- High Engine loads encountered while towing a vehicle.
- Using low octane gasoline in a high-compression engine.
- Too much timing advance for the type of fuel being used.
- Higher air density, (this can be caused by starting a calibration at high altitude and then traveling to a lower one, or the addition of forced induction).
- Increased temperatures and pressure in the combustion chamber due to inadequate engine cooling.
- Excessive inlet air temperature.
- Spark plugs with an improperly high heat range.
- A non-central spark plug location in the combustion chamber.
- An elongated combustion chamber design.
- Too lean of an air/fuel mixture.

The following tuning adjustments can be performed on an engine to reduce or eliminate knocking:

- Reduce ignition timing.
- Verify that the air/fuel mixture is adequate for your engine set up.
- Verify that the spark plugs are of proper heat range.

Pre ignition is the ignition of the charge in the combustion chamber before the spark occurs. This type of ignition is caused by a very hot, or even incandescent surface in the combustion chamber. These “hot spots” can be an overheated spark plug, a glowing remnant of carbon in the chamber or even a hot exhaust valve edge. The pre ignition condition flame front rapidly expands while the piston is still on its way up the bore. Due to the very high pressure generated by the expanding flame front and the piston approaching TDC, the combustion chamber

pressure rises rapidly causing audible knocking. Detonation and pre ignition typically have a cause and effect relationship; when detonation is prolonged and overheats the spark plug to the point where the tip glows, pre ignition occurs. Preventative measures can be taken to avoid pre ignition by using spark plugs with the correct heat range, avoiding detonation by using fuel with the correct octane rating for your application, and when building an engine, ensuring that there are no machined components with sharp corners in the combustion chamber. Also, the cooling system must be in good working condition to effectively cool the combustion chamber. Sustained operation of an engine in either of these conditions can result in severe engine damage.

At low manifold pressure the flame front is slower due to the low density of mixture in the combustion chamber. Because peak manifold pressure is optimal at 15–20 degrees ATDC and the burn rate is slower at very low manifold pressure, the ignition point must be started earlier. The main ignition map typically has high ignition timing values during times of low manifold pressure and high RPM, which gradually decreases at load increases.

As the throttle is opened, the density of the mixture increases and the flame propagation increases in speed. The timing must be reduced as load and RPM increase to keep the peak pressure at approximately the same point and reduce the chances of knocking.

With forced induction engines, the burn rate increases as charge density is increased. In this example, timing must be reduced because of the faster burn rate, and to further reduce the chances of knocking. On forced induction engines, the inlet charge temperature is elevated because of the heat generated by compressing the air. Utilizing an intercooler or after-cooling system usually helps reduce the inlet charge temperature. But in many cases this still will not bring the inlet charge down to ambient temperature, making the engine more susceptible to knocking.

Remove the spark plugs each time the timing is increased to a higher value and check for signs of detonation. The spark plug is the best indicator of what is happening in the engine because it is such an integral part of the combustion chamber. If you see small flecks of black deposits, or very small shiny beads on the porcelain of the plug, there is a good chance that the engine is knocking. Retard the timing to eliminate the knocking, enrich the mixture, or use a higher octane of fuel.

Ignition Coils

An ignition coil is charged when current flows through the primary side of the coil. A coil driver is required to sink the current and dissipate the heat generated during operation. The coil outputs from the Infinity are used to trigger the drivers. The drivers can either be contained within the coils themselves or they can be contained within a stand-alone device installed between the Infinity and the coils.



There are several different types of ignition systems in use on modern cars. They are:

- Distributed spark using a single coil and a distributor for all cylinders.
- Wasted spark using one coil for two cylinders.
- Direct Fire using one coil on plug of each cylinder.

Distributed Spark

Distributed spark systems have been around the longest. As the name implies, the spark is distributed to the plugs via a coil output to a rotor, then through the distributor cap to the appropriate plug via a high-tension (HT) lead. This is the most complex system because of the relationship that has to be maintained between the firing point, rotor to cap terminal angle, and engine position. Distributed spark systems also rely on a mechanical link between the engine and ignition output, which adds another dimension of unreliability-and to a minor extent-inaccuracy in timing. In addition to these problems, distributed spark systems typically produce the least intense spark of all ignition systems. The time to achieve full charge diminishes as engine speed increases; therefore the coil charge is reduced as a function of RPM. In spite of the potential problems with distributed spark systems, they have been used successfully for many years on high-performance engines. Distributed spark ignition systems respond well to spark amplification within their design limits.

Wasted Spark

Wasted spark systems employ one coil for two cylinders. The term “wasted spark” comes from the fact that each plug fires every engine revolution. On a 4-cycle engine, the piston is at Top Dead Center (TDC) two times for every cycle; once for firing and again during the overlap phase. The wasted spark coil fires one plug Before Top Dead center (BTDC) and another plug just before the overlap phase (at the latest part of the exhaust stroke before the exhaust valve closes). Wasted spark systems have a higher potential for spark intensity because the duty of charging and discharging is split between the coils, which allows for more charge time per coil. Additionally, wasted spark systems build up less heat in the coil, making it more reliable. Wasted spark systems have been in use since the mid 80’s on GM cars and on motorcycles for considerably longer than that. There are no moving parts, no complicated relationships with a cap and rotor to maintain, and they deliver very accurate spark timing. Furthermore, multi-channel spark amplification systems to enhance spark duration or intensity are available for wasted spark ignition systems.

Direct Fire

Direct fire systems employ one coil on each spark plug and is the most reliable system used today, (this type of system is used on most modern cars). Each coil fires sequentially in the cylinder firing order. The charge time for each coil is twice as long as those of a wasted spark system, which allows direct-fire, coil manufacturers to build compact, lightweight coils that retain sufficient spark energy. There are no moving parts to wear out and no HT leads that will deteriorate. The lack of HT leads in direct fire systems is a major advantage for an EFI-equipped car because there is a very low incidence of noise due to leaking or improperly routed wires. There have been incidences of the terminal from a direct-fire coil (that attaches to the spark plug) cracking and subsequently causing Radio Frequency Interference (RFI) or “noise” to the ECU. This will cause engine operation problems, but it should be noted that these cases are extremely rare.

Combustion Chamber

The combustion chamber plays an important role in the amount of ignition timing that can be used for the various operational phases of an engine. The most common type of combustion chamber design used in contemporary engines is a four-valve/cylinder, pent roof chamber. There are many other types of combustion chambers, such as a wedge, hemispherical, and canted valve, to name a few. Ideally, it is best to initiate flame propagation at the geometric center of the chamber. However, this is typically impossible to do because the spark plug is usually

located at the top or edge of the combustion chamber. The reason it is desirable to have the flame front start at the geometric center of the combustion chamber is because there is less chance of auto ignition of the mixture.



A pent roof combustion chamber places the spark plug near the center of the combustion chamber. Wedge combustion chambers are the most sensitive to spark knock because of the distance the flame front must travel within the bore prior to the power stroke.

When ignition occurs, a flame kernel starts at the spark plug electrode and expands across the combustion chamber. As the front progresses across the chamber, the hot expanding gas compresses and heats the end gasses and mixture at the opposite end of the chamber. If the pressure, and consequently temperature, inside the chamber increases beyond the flash point of the end gas, auto ignition occurs. Because the pent roof type of chamber has a spark plug that is nearer to the geometric center of the chamber, the flame travels more evenly across the combustion chamber, leaving very little end gas that can be compressed or ignited by the advancing flame front. Thanks to the short distance the flame front has to travel in pent roof type chambers, ignition timing usually does not have to be as advanced as much as a wedge type chamber, to achieve maximum torque. We find that there is usually about five to eight degrees less timing required for pent roof combustion chambers than for wedge types.

Charge motion, which is comprised of intake swirl and squish; increase combustion speed when compared to a standard combustion chamber. The combination of these factors increases the mean effective pressure (MEP), lowers fuel consumption, and delivers smaller cycle-to-cycle variations at full throttle operation.

In addition to the performance benefit of effective charge motion, the resulting factors reduce Hc emissions, with a slightly increased Nox component. At partial load the benefits of charge motion vs. a standard combustion chamber are similar, but due to the decrease in density of the intake charge, not very.

The combination of swirl and squish is greater than either squish or swirl alone. Swirl improves mixture preparation and is mostly responsible for reducing ignition delay and cycle-to-cycle variations. Swirl is accomplished through the inlet port design or by using shrouded valves in the combustion chamber. As engine speed increases, the swirl motion increases along with it. Cycle-to-cycle variations decrease with increasing swirl action.

Squish is accomplished via a small gap between the head deck and the piston top. The decrease of this gap drives the inlet charge toward the spark plug electrode. An additional benefit of having this small gap is the reduction of end gas volume at the extreme edges of the cylinder. This reduces the tendency for spark knock and leads to a

reduction of Hc emissions.

Cycle-to-cycle variation refers to a situation where an engine operates on the threshold of knocking or detonation throughout the engine cycles and is based on the average peak pressure of all of the cycles. The cycles with lower peak pressures may not be prone to detonation, while those with higher peak pressures may detonate with increasing intensity as peak pressure increases. Increasing this cyclic variation will increase the number of cycles that detonate, and decreasing the number leads to less cycles that detonate.

Ignition Delay is the point at which perceptible inflammation of the mixture and a pressure rise in the combustion chamber occurs. The time between when spark occurs at the spark plug and when inflammation of the mixture occurs is the delay time. This delay is caused by the chemical reactions that take place when the rate of reaction after the delay accelerates to an extent that noticeable combustion and a rise in cylinder pressure and temperature occurs. The chemical reaction within and on the surface of the initial flame kernel causes energy to be released during the ignition delay period. When the flame front is at this initial stage of propagation there are energy losses via conduction, radiation, and convection of heat. If too much of this energy is lost, the mixture will fail to propagate and a misfire will result.

As compression ratio increases the requirement for charge motion in the chamber is reduced. Engines that have high compression ratios generally require reduced ignition timing requirements due to the increased flame speed. The design of the combustion chamber in a high compression engine is necessarily small. The compactness of the chamber imparts its own charge motion and squish into the mixture.

We have included some sample ignition timing maps for gasoline engines that are typical for use on a street car. These examples include a naturally aspirated engine, forced-induction engine, and a high-compression engine. **These are conservative samples that should be used as a starting point only.**

The tuner of the engine must use good judgment when selecting the appropriate timing map for the engine

Naturally Aspirated Piston Engines W/ Pent Roof Combustion Chamber

Ignition Timing

L	100	15	22	32	33	33	33	33	33
O	90	15	22	33	34	34	34	34	34
A	80	15	22	33	35	35	35	35	35
D	70	15	23	35	35	35	35	36	36
	60	15	24	35	35	36	36	37	37
I	50	15	24	35	35	36	36	37	37
N	40	15	24	37	37	38	39	40	40
	30	15	24	37	37	38	39	40	40
K	20	15	25	40	45	45	45	45	45
P	10	15	25	40	45	45	45	45	45
A		1000	2000	3000	4000	5000	6000	7000	8000

RPM

Turbocharged Piston Engines W/ Pent Roof Combustion Chamber

Ignition Timing

L	300	11	14	23	23	24	24	24	24
O	275	11	15	24	24	25	25	25	25
A	250	11	15	24	24	26	26	26	26
D	225	11	16	24	26	27	27	27	27
	200	12	17	26	27	27	27	27	27
	175	12	19	28	29	29	29	29	29
I	150	12	20	29	30	30	30	30	30
N	125	12	20	30	30	31	31	31	31
	100	15	22	32	33	33	33	33	33
K	75	15	23	35	35	35	35	36	36
P	50	15	24	35	35	36	36	37	37
A	25	15	25	40	45	45	45	45	45
		1000	2000	3000	4000	5000	6000	7000	8000

RPM

Naturally Aspirated Piston Engines W/ Wedge Combustion Chamber

		Ignition Timing							
L	100	15	22	32	35	35	35	35	35
O	90	15	22	33	35	35	35	35	35
A	80	15	22	34	35	35	35	35	35
D	70	15	23	34	35	36	36	37	37
	60	15	24	35	35	36	36	37	37
I	50	15	24	35	35	36	36	37	37
N	40	15	24	37	37	38	39	40	40
	30	15	24	37	39	39	39	40	40
K	20	15	25	40	47	47	47	47	47
P	10	15	25	40	47	47	47	47	47
A		1000	2000	3000	4000	5000	6000	7000	8000
		RPM							

Turbocharged Piston Engines W/ Wedge Combustion Chamber

		Ignition Timing							
L	300	11	14	23	23	24	24	24	24
O	275	11	15	24	24	25	25	25	25
A	250	11	15	24	24	26	26	26	26
D	225	11	16	24	26	27	27	27	27
	200	12	17	26	27	27	27	27	27
	175	12	19	29	30	30	30	30	30
I	150	12	20	30	31	31	31	31	31
N	125	12	20	32	32	33	33	33	33
	100	15	22	34	35	35	35	35	35
K	75	15	23	34	35	36	36	37	37
P	50	15	25	40	47	47	47	47	47
A	25	15	25	40	47	47	47	47	47
		1000	2000	3000	4000	5000	6000	7000	8000
		RPM							

TPS (Throttle Position Sensor)

The TPS determines the position of the throttle blade in the throttle body. This input is used to determine rate of throttle angle change (both positive and negative), idle position, and discrete throttle opening for TPS-based calibrations. The TPS typically is a potentiometer bolted to the end of the throttle shaft. Rotating the throttle varies the resistance, and consequently, the voltage returned to the ECU is a function of that resistance. The rate of change is measured to determine whether a vehicle is accelerating or decelerating. Based on this rate of change, the proper amount of fuel is either added or subtracted from the base calibration to achieve the proper amount of fuel for the operating condition.



The TPS is also used to determine if the vehicle is idling. When the throttle is at rest, the vehicle is considered to be either idling or under heavy deceleration, and the fuel and ignition calibrations are adjusted for optimum idle characteristics. The TPS can be used as a calibration input if the AEM Infinity is set up to be a throttle position vs. RPM based mapping scheme. This type of mapping allows the tuner to set up the fuel map based on the throttle angle from 0 to 100% on the Y-axis of the map, with the X-axis being RPMs. This type of mapping is usually best for naturally aspirated racing engines with individual runner inlet manifolds and no plenum chamber or very aggressive cams.

While on the subject of throttle opening we must caution you to make sure that full throttle is achieved by having someone verify that the throttle blade is opening fully and up against the stop on the throttle body while you depress the throttle. Also, make sure that nothing interferes with the full range of the throttle opening, such as a floor mat.

MAP (Manifold Absolute Pressure)

Before any discussion is held of what a MAP sensor is, it is necessary to understand what manifold pressure is. The definition of pressure is the force per unit area, thus it is an intensive quantity formed as a ratio force and area. So if a 100-pound force is exerted on a piston that has a total area of 100 in² the pressure acting on each square inch is 100lb/100 in² or 1 PSI. If the same force were to be applied to a piston with an area of only 1 in² the pressure exerted on the piston would be 100 lb/ 1 in² or 100 PSI. Now consider if a 100-pound person stepped on a nail that has a tip that is only .010" diameter. This would yield a pressure of 10,000 pounds. (100 lb / .010 in² = 10,000 pressure)

Realistically, there is no such thing as "manifold vacuum," just low manifold pressure. The average air pressure

exerted on Earth under standard conditions is 14.7 psi or 101.325 kilopascals (kpa). An engine ingests air by creating a differential of pressure across the engine via the movement of the pistons in their bores. When a piston moves down the bore, pressure in the bore is reduced. When the inlet valve opens, the awaiting relative higher-pressure air above the inlet valve enters the chamber and fills the void caused by the motion of the piston in the bore. On an engine without a means of forcing air into the engine, the most this pressure can be is whatever the atmospheric pressure of the day is. At sea level the average pressure is 14.7 psi.

It is common to refer to low manifold pressure as vacuum, which is how we will refer to low pressure for the purposes of this discussion. Pressure is measured in two ways: one is absolute pressure, and the other is gauge pressure. The difference between these is where the zero point of each scale starts. With absolute pressure, zero is a complete void of all pressure. With the more common gauge pressure, zero is at standard atmospheric pressure (14.7 psi). Anything below 14.7 psi is referred to as vacuum and anything above that is referred to as boost or positive pressure.

Closed or very small throttle angles are associated with low manifold pressure (a vacuum on the gauge measuring style), and large throttle angles or full throttle is considered high manifold pressure (0 on the gauge measuring style).

Typical boost or vacuum gauges used in automotive applications use the gauge type of readout. In automotive engineering, the absolute method of measuring pressure is used. To illustrate the different ways to read manifold pressure refer to the accompanying chart.

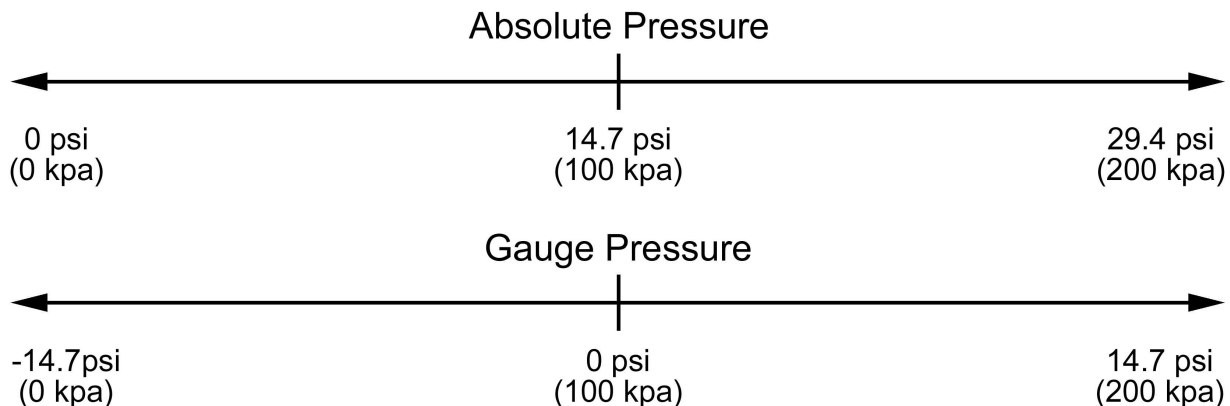

We find it easiest to work with the accepted standard of kilopascals (kpa) of absolute pressure. It is important to know the relationships of the various nomenclatures of pressure. The units of pressure in use today are;

1 bar (b) = 100 kilopascals (kpa) = 14.5 psi = 29.529" Hg

1 atm. = 101.325 kpa = 14.7 psi = 29.92" Hg = 1.01325 b

PSI Absolute	Kpa	Inches Hg	Bar	Pressure Gauge
1.00	6.89	2.04	0.07	-27.89 in Hg
2.00	13.79	4.07	0.14	-25.86
3.00	20.68	6.11	0.21	-23.82
4.00	27.58	8.14	0.28	-21.79
5.00	34.47	10.18	0.34	-19.75
6.00	41.37	12.22	0.41	-17.71
7.00	48.26	14.25	0.48	-15.68

8.00	55.16	16.29	0.55	-13.64
9.00	62.05	18.32	0.62	-11.61
10.00	68.95	20.36	0.69	-9.57
11.00	75.84	22.40	0.76	-7.53
12.00	82.74	24.43	0.83	-5.50
13.00	89.63	26.47	0.90	-3.46
14.00	96.53	28.50	0.97	-1.43
14.70	101.35	29.93	1.01	0
15.00	103.42	30.54	1.03	0.3 psi
16.00	110.32	32.58	1.10	1
17.00	117.21	34.61	1.17	2
18.00	124.11	36.65	1.24	3
19.00	131.00	38.68	1.31	4
20.00	137.90	40.72	1.38	5
21.00	144.79	42.76	1.45	6
22.00	151.68	44.79	1.52	7
23.00	158.58	46.83	1.59	8
24.00	165.47	48.86	1.65	9
25.00	172.37	50.90	1.72	10
26.00	179.26	52.94	1.79	11
27.00	186.16	54.97	1.86	12
28.00	193.05	57.01	1.93	13
29.00	199.95	59.04	2.00	14
30.00	206.84	61.08	2.07	15
31.00	213.74	63.12	2.14	16
32.00	220.63	65.15	2.21	17
33.00	227.53	67.19	2.28	18
34.00	234.42	69.22	2.34	19
35.00	241.32	71.26	2.41	20
36.00	248.21	73.30	2.48	21

Bold type is standard atmosphere

Vacuum in Hg"

Standard ATM

Pressure in PSI

The MAP sensor provides manifold pressure information to the ECU for calibration based on MAP vs. RPM. The MAP information is used in both the fuel and ignition Y-axis of their respective maps. On racing engines that use individual runner manifolds, a TPS based fuel map can be used while the ignition can be MAP based. This is desirable because the ignition should always be load based to provide knock free operation.

A MAP sensor reads in absolute pressure, just like the name implies. The amount of pressure indicated by the sensor depends on the amount of voltage feedback delivered to the ECU. As the throttle is opened and closed, or boost is built up in the manifold, the sensor reacts to the changing pressure and outputs a voltage signal to the ECU based on the given pressure.

The MAP sensor has three leads: 5V+ into the MAP sensor, a return to the ECU based upon the resistance of the MAP sensor, and a ground. A MAP sensor MUST have a hose routed to it from the inlet manifold in order to read

manifold pressure and it MUST receive a constant pressure signal to it at all times. If the pressure signal fluctuates, the calibration will be adversely affected because the fuel and ignition values will cycle with the MAP signal.



To avoid varying MAP signals, the pressure line must be connected to the intake plenum. In the case of individual runner manifolds, TPS-based mapping is best.

If a MAP sensor is used for boost compensation or load sensitive ignition timing, an accumulator must be used. An accumulator is a common closed container that has a hose from each runner routed to it. An accumulator dampens the pulsing commonly found in this type of manifold set up, which will aid in the delivery of a steady MAP signal. Note: A fuel pressure regulator can have its pressure source routed to an accumulator for the same reasons.

The AEM Infinity has a variety of MAP sensor ranges to suit everything from naturally aspirated engines, to forced induction engines up to whatever boost can be generated by the turbo or supercharger(s).

IAT (Inlet Air Temperature)

Manifold Air Temp Sensors (MAT) and Inlet Air Temp Sensors (IAT) are variable resistance thermistors that send a return voltage signal back to the ECU based on the inlet air temp either in the inlet manifold or in the inlet duct to the throttle body. The ECU outputs a +5V power to the sensor and the return voltage is based on the resistance of the sensor. These sensors are also used as auxiliary temp sensors for any air temp measurement, such as intercooler inlet and outlet temps.



The AEM Infinity is compatible with virtually all MAT & IAT sensors. Based on the inlet air temp readings provided by an MAT or IAT, an ECU can add or subtract fuel or ignition timing depending on the given conditions. For example, a typical use for an IAT sensor is to change the ignition timing and fueling of an engine based on inlet air temp. This is particularly useful on forced induction engines where inlet air temps can increase dramatically.

For more information, go to [Air Temperature](#) ⁹⁶

CLT (Coolant Temperature)

The coolant temperature sensor (CLT) is a variable resistance thermistor (thermal resistor) that sends a return voltage back to the ECU based on the temperature of the engine coolant. This sensor can also be used for virtually any other type of automotive fluid if it is located in that liquid's respective reservoir. Unlike other types of sensors that emit voltage signals to the ECU, with CLTs the ECU outputs a +5V signal to the CLT and the sensor's resistance determines the return voltage. The AEM Infinity is compatible with virtually all CLT sensors.



The CLT provides the ECU with engine temp information. The AEM Infinity modifies the base fuel calibration during start and warm up based on the CLT input. In addition to adding fuel, a CLT can signal to the ECU to modify ignition timing at varying engine temps for optimum performance. On race cars, ignition timing is typically advanced during warm up to heat the engine faster. Race cars use an ignition based warm up because usually idle speed motors are not used. On streetcars, where clean emissions are important, we reduce timing based on CLT input to light the catalytic converter(s) off sooner.

For more information, go to [Coolant Temperature](#) ⁹⁸

O2 (Oxygen Sensor)

There are many types of O2 sensors that are employed by vehicle manufacturers, and it is well beyond the scope of this manual to describe all of them. An O2 sensor provides a reading of the air/fuel ratio (AFR) to the ECU so that it can make the necessary fuel calibration corrections to achieve a desired Air Fuel Ratio (AFR).



An O2 sensor works by sensing whether there is an abundance or lack of oxygen in the exhaust gases, depending on whether the gas mixture is too rich or too lean. If there is excess oxygen and the mixture is too lean, output voltage from the O2 sensor to the ECU will be high. The ECU may then compensate by adding fuel. The converse is true of rich mixtures.

Common O2 sensors include 3, 4, and 5-wire heated or wide-band sensors. Three- and 4-wire sensors are ideal for determining whether a vehicle's AFR is at the optimum stoichiometric ratio. Stoichiometric ratio refers to the ideal mixture of fuel and air by mass to completely consume both reactants (gas and air) with nothing left over. Based on the properties of most pump gasoline used today this ratio is typically a 14.64:1 air/fuel ratio. Although this ratio provides the best combustion characteristics with the least emissions output and optimum catalytic converter performance, it is NOT the best AFR for maximum power at full throttle or under boost. This mixture is too lean and may cause engine damage.

Typical production vehicle oxygen sensors rely on "Nernst Cell" technology, commonly called "Narrow Band" and sometimes erroneously described as "Wide Band." This is a very cost effective method that outputs a voltage based on the oxygen content of the gas being sampled. It is accurate in the region surrounding stoichiometric

operation and leaner. Unfortunately, in the rich region where high performance engines usually operate, their accuracy and repeatability is virtually non-existent.

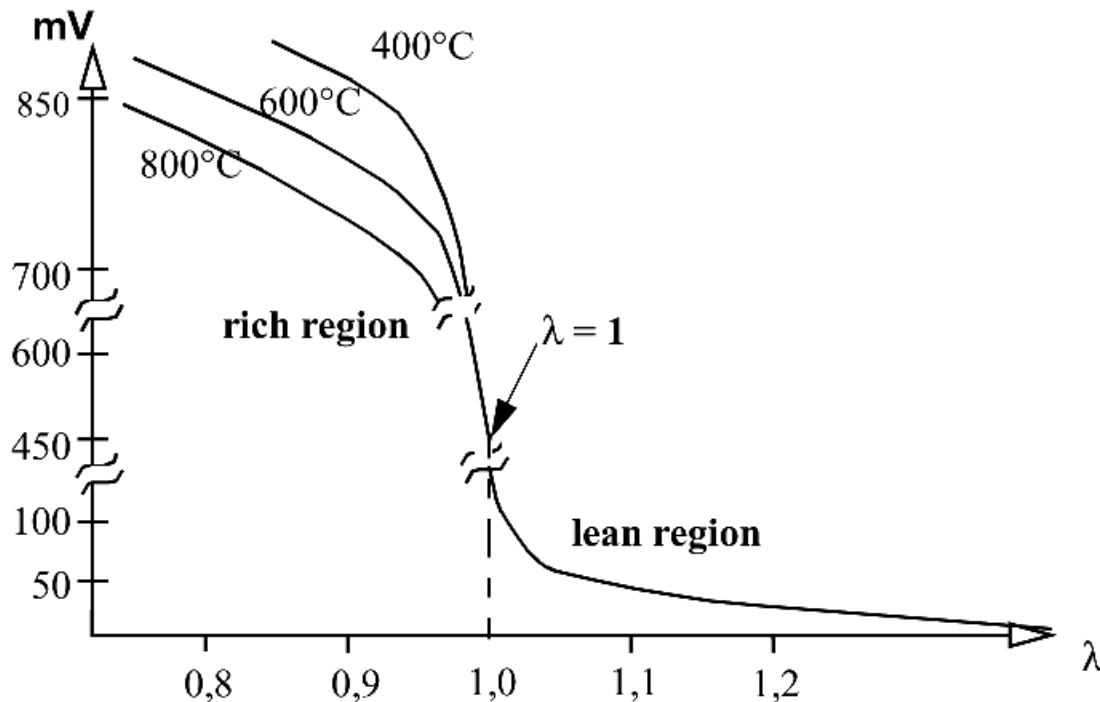

Characteristic curve of a Nernst Cell O₂ Sensor

The rich region output of narrow band O₂ sensors is temperature dependent, which renders it useless if an accuracy better than 1.5:1 AFR is desired. This is immediately obvious given the fact that a single output voltage actually represents wildly different air fuel ratios depending on the unregulated and unmeasured sensor temperature. These sensors were designed for operating closed loop around stoichiometry (14.64:1 for gasoline), and for performance tuning they are useless.

The AEM Infinity includes dual internal UEGO controllers. Only a Bosch LSU4.2 UEGO Sensor may be used. This system is accurate and repeatable to 0.1 of an air/fuel ratio point. With this, there is no abrupt oscillation as found in many competitor systems, which typically utilize a narrow band oxygen sensor detecting only stoichiometry. This type of UEGO sensor is commonly referred to as "laboratory grade" and works on a different principle than the narrow band oxygen sensor found in most vehicles. Its unique design makes precision AFR measurements possible over the entire operating range.

UEGO sensors use a “current pump” to determine the actual oxygen concentration within the sensing element. The output is in the form of a very small current, which varies depending on the air-fuel ratio. This is completely different from a narrow band oxygen sensor, which directly outputs a voltage. The UEGO sensor design allows measurement of the exact air fuel ratio over the entire operating range.

The following is a chart of typical AFRs. **Note that every engine is different and this may not be the optimum set up for your particular vehicle.** The AFRs on this chart are very conservative to minimize the potential for engine damage. These AFRs depend on the condition that ignition timing and fuel octane are adequate enough to prevent knocking. The very low loads found in the lower right corner occur during deceleration, and because there is no “work” being done by the engine, AFRs during deceleration can be very lean. We have seen AFRs of 20.0:1 during deceleration runs.

Naturally Aspirated Piston Engines W/ Pent Roof Combustion Chamber

		<i>Air/Fuel Ratio</i>							
L O A D I N K P A	100	13.0:1	13.0:1	13.0:1	13.0:1	13.0:1	13.0:1	12.8:1	12.8:1
	90	13.5:1	13.5:1	13.5:1	13.5:1	13.5:1	13.5:1	13.5:1	13.5:1
	80	14.0:1	14.0:1	14.0:1	14.0:1	14.0:1	14.0:1	14.0:1	14.0:1
	70	14.0:1	14.2:1	14.2:1	14.2:1	14.2:1	14.2:1	14.2:1	14.2:1
	60	14.0:1	14.7:1	14.7:1	14.7:1	14.7:1	14.7:1	14.7:1	14.7:1
	50	14.0:1	14.7:1	14.7:1	14.7:1	14.7:1	14.7:1	14.7:1	14.7:1
	40	14.0:1	14.7:1	14.7:1	14.7:1	14.7:1	14.7:1	14.7:1	14.7:1
	30	14.0:1	14.7:1	14.7:1	14.7:1	14.7:1	14.7:1	14.7:1	14.7:1
	20	14.0:1	14.7:1	14.7:1	14.7:1	14.7:1	15:1	15:1	15:1
	10	14.0:1	14.7:1	14.7:1	15:1	15:1	15:1	15:1	15:1
		Idle							Maximum
		RPM							

Turbocharged Piston Engines W/ Pent Roof Combustion Chamber

		<i>Air/Fuel Ratio</i>							
L O A	300	13.0:1	12.5:1	12.2:1	12.2:1	12.2:1	12.2:1	12.2:1	12.2:1
	275	13.0:1	12.8:1	12.5:1	12.5:1	12.2:1	12.2:1	12.2:1	12.2:1
	250	13.0:1	12.8:1	12.5:1	12.5:1	12.2:1	12.2:1	12.2:1	12.2:1

D	225	13.0:1	12.8:1	12.8:1	12.8:1	12.5:1	12.5:1	12.5:1	12.5:1
	200	13.0:1	12.8:1	12.8:1	12.8:1	12.5:1	12.5:1	12.5:1	12.5:1
I	175	13.0:1	13.0:1	13.0:1	12.8:1	12.8:1	12.8:1	12.8:1	12.8:1
N	150	13.0:1	13.0:1	13.0:1	13.0:1	13.0:1	13.0:1	12.8:1	12.8:1
	125	13.0:1	13.0:1	13.0:1	13.0:1	13.0:1	13.0:1	12.8:1	12.8:1
K	100	13.0:1	13.0:1	13.0:1	13.0:1	13.0:1	13.0:1	12.8:1	12.8:1
P	75	14.0:1	14.2:1	14.2:1	14.2:1	14.2:1	14.2:1	14.2:1	14.2:1
A	50	14.0:1	14.7:1	14.7:1	14.7:1	14.7:1	14.7:1	14.7:1	14.7:1
	25	14.0:1	14.7:1	14.7:1	14.7:1	14.7:1	14.7:1	14.7:1	14.7:1
		Idle					Maximum		

RPM

The AFR is often referred to as a Lambda (λ) number. A Lambda of 1.00 is equal to the stoichiometric ratio for the reactants in a system. For our purposes, the stoichiometric ratio is the ratio for the amount of ANY fuel used in an internal combustion engine. With Lambda measurement, any number higher than 1.00 is considered lean (more air than necessary to react with the fuel) and any number lower than 1.00 is considered rich.

Although Lambda is the term most often used when working with O₂ sensors, we will use AFR in this manual because it is the most common term used when referring to internal combustion engines. The following is a chart for converting Lambda values to AFRs.

Lambda to AFR Conversion Chart

Lambda	AFR	Lambda	AFR	Lambda	AFR	Lambda	AFR
1.3	19.03	1.14	16.69	0.98	14.35	0.82	12.00
1.29	18.89	1.13	16.54	0.97	14.20	0.81	11.86
1.28	18.74	1.12	16.40	0.96	14.05	0.8	11.71
1.27	18.59	1.11	16.25	0.95	13.91	0.79	11.57
1.26	18.45	1.1	16.10	0.94	13.76	0.78	11.42
1.25	18.30	1.09	15.96	0.93	13.62	0.77	11.27
1.24	18.15	1.08	15.81	0.92	13.47	0.76	11.13
1.23	18.01	1.07	15.66	0.91	13.32	0.75	10.98

1.22	17.86	1.06	15.52	0.9	13.18	0.74	10.83
1.21	17.71	1.05	15.37	0.89	13.03	0.73	10.69
1.2	17.57	1.04	15.23	0.88	12.88	0.72	10.54
1.19	17.42	1.03	15.08	0.87	12.74	0.71	10.39
1.18	17.28	1.02	14.93	0.86	12.59	0.7	10.25
1.17	17.13	1.01	14.79	0.85	12.44	0.69	10.10
1.16	16.98	1	14.64	0.84	12.30	0.68	9.96
1.15	16.84	0.99	14.49	0.83	12.15	0.67	9.81

KNK (Knock Sensor)

The knock sensor is like a microphone mounted to the engine block that is used to detect combustion knock. Every engine is different with respect to the amount of noise it generates. In most production engines, the sensitivity of the knock sensor is based on an average noise profile generated during dyno testing. A knock sensor that has a slightly lower threshold of sensitivity to knock is used to compensate for variances in engine noise. When the engine makes noise in frequencies and amplitude higher than the baseline noise profile, the sensor senses knock and the ECU reduces ignition timing until the noise (knock) is suppressed. Engines that have knock sensors on them from the factory need to have the baseline noise profile recorded when setting up the AEM Infinity.



For information on tuning with knock sensors, go to [Knock Control](#) 199

PPS (Pedal Position Sensor)

For safety, modern cars use electronic throttle control (ETC) or sometime called drive-by-wire (DBW) throttle bodies. The butterfly valve is no longer directly controlled by the throttle pedal via a simple cable. The ECU relies on inputs from the pedal position sensors and other inputs from various sensors. An output is then provided to control the DBW motor.

The PPS is similar to a TPS as they are both potentiometers. However, instead of mounted on the butterfly valve,

PPS are mounted on the throttle pedal. Pushing in the "gas" effectively rotates the pedal and varies the resistance. Consequently, the voltage returned to the ECU is a function of that resistance. The rate of change is measured to determine whether a vehicle is accelerating or decelerating. Based on this rate of change, the proper amount of fuel is either added or subtracted from the ECU calibration to achieve the proper amount of fuel for the operating condition.

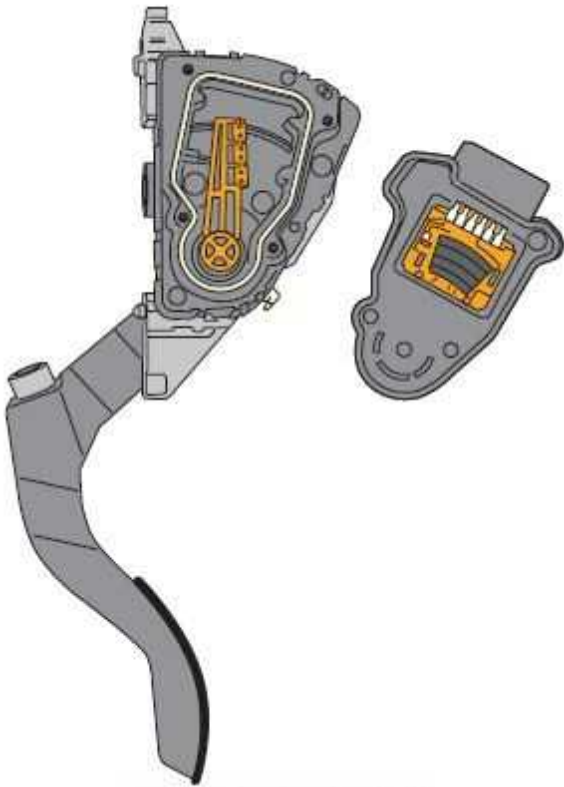

CMP/CKP (Cam/Crank Position)

Cam and crank position sensors are typically either VR (Variable Reluctance) "Mag" or Hall Effect. Hall Effect sensors use three wires and produce a digital square wave. VR sensors use two wires and produce an analog sinusoidal wave. VR sensors are better for high temperature applications and are less expensive than "Hall" sensors.

When the "teeth" on a toothed wheel pass by a sensor, the sensor creates a voltage pattern that is used by the ECU for many important calculations. The example below shows two different toothed wheels, one that rotates with the crankshaft. The other rotates with the camshaft (1/2 engine speed). Representative voltage signal patterns for one complete engine cycle (2 revolutions) are also shown. The calibration file must contain the proper settings to define this pattern for the ECU.

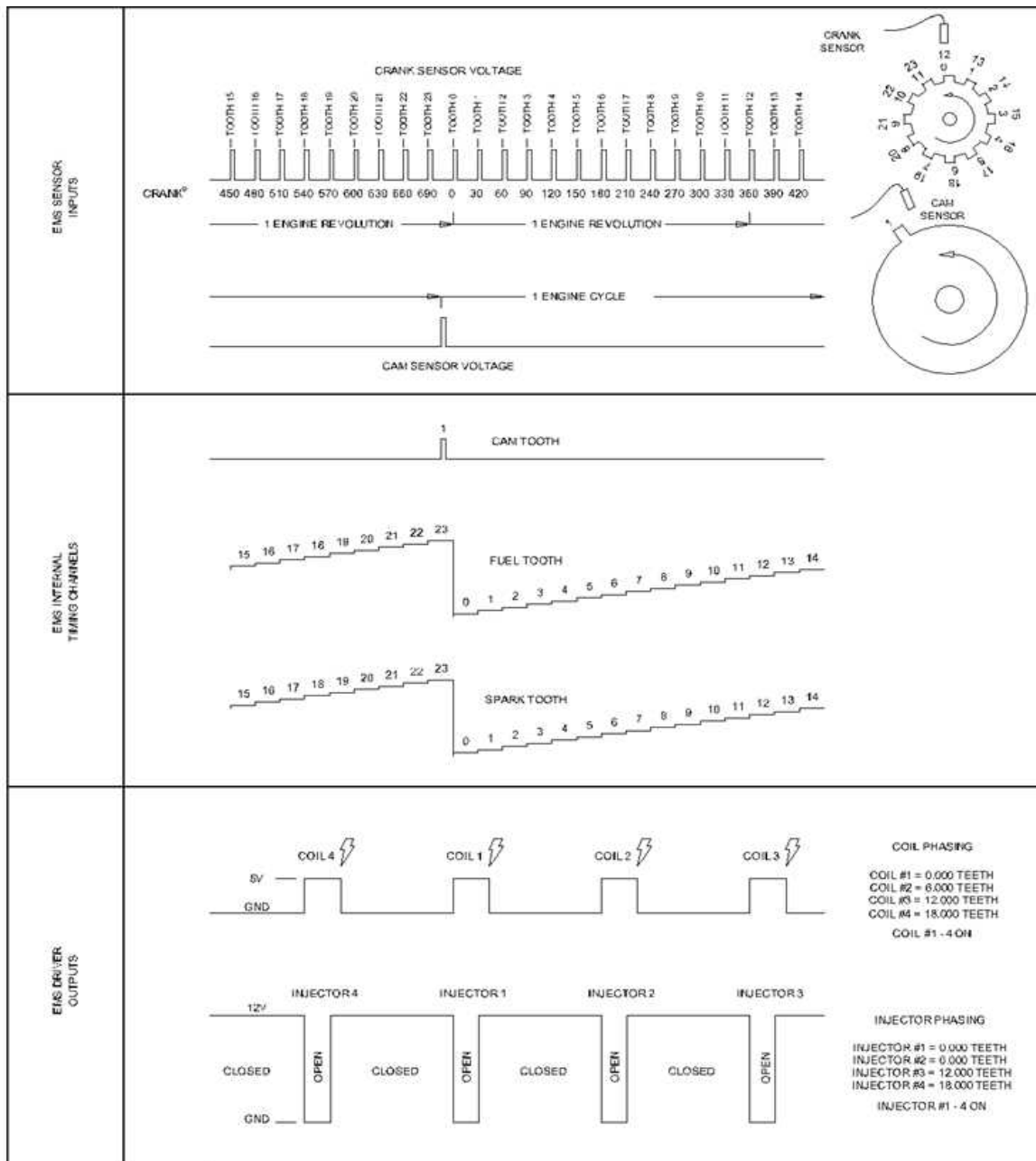

The diagram above illustrates a very basic even tooth pattern along with fuel output phasing and spark output phasing setups. Many different crank and cam input configurations are possible with an AEM Infinity, however, the firmware used is specific to the timing pattern.

IAC (Idle Air Control)

Idle air control (IAC) systems are used to stabilize idle speed during cold engine and after warm-up operations. The IAC system regulates the volume of air bypassed around a closed throttle butterfly valve. The Infinity controls the IAC system by applying various input signals from the user-programmable software file. There are two major types of IAC systems. The stepper idle air control motor is, typically used by Toyota, Dodge, Mitsubishi, etc. The pulse

width idle air control valve is commonly used by Honda, Subaru, Ford, Nissan, Volkswagen, etc. This instruction manual will address both types of IAC systems.

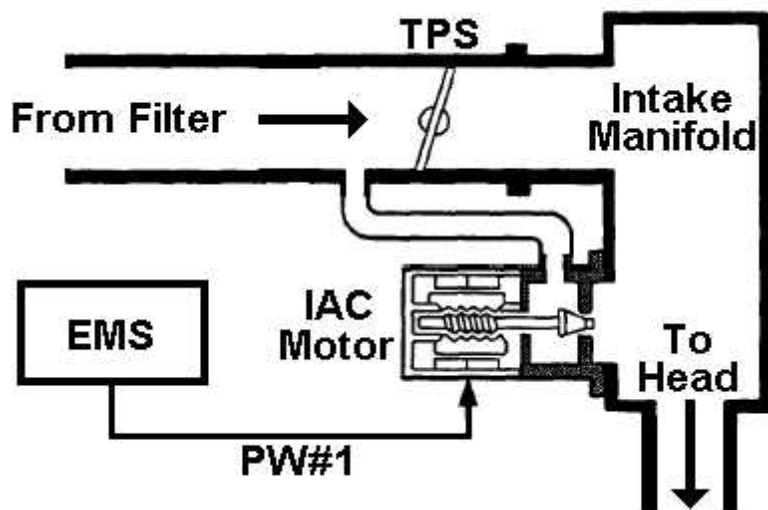

The stepper motor IAC valve (shown below) consists of a step-motor with a seat, magnetic rotor, valve, four wires to each of the four coils and can vary bypass airflow by positioning its valve into one of many possible steps. Basically, the higher the IAC valve step number, the larger the airflow opening and the greater the volume of air bypassed around the closed throttle. However, if a voltage pulse is applied backwards, the motor will step in the other direction. The motor step will open or close, based on the number of pulses and the direction desired.



The advantage of a step type IAC motor is that once the motor is in the proper location, no signal or power is required to maintain this position. The only time action needs to be taken is when changing the location of the motor. The downside is there is an uncertainty to where the motor is at any given time. This can be overcome by routinely resetting the IAC motor to a known location. With tuning, this is achieved by stepping the motor all the way to its limit. However, this may damage the motor if not set correctly. This will reset the motor.

Stepper motors do not have a position sensor. The location at engine start has to be assumed since there is no time for it to reset. Therefore, it must be parked in a known location when the engine is turned OFF. Parking of the stepper motor is crucial. After the engine is shut off, the Infinity keeps power to the main relay and then resets and parks the stepper motor. This takes about 5–7 seconds and is usually unnoticed by the user.

The other major IAC system is a pulse width duty cycle valve, shown below. This system regulates air bypass volume by utilizing a duty cycle controlled solenoid. This electric solenoid controls an air valve which blocks passage of air from the intake pipe to the intake manifold. Since this solenoid is incapable of flowing high air volume, a separate mechanical air valve is typically used to perform cold fast idle. With this type system, the Infinity varies bypass airflow by changing the duty ratio of the command signal to the IAC valve. By increasing the duty ratio, the Infinity holds the air bypass valve open longer, causing an increase in idle speed.



The advantage of this type of IAC system is that it does not need to park and because it does not take steps, the valve is always at a known position. The disadvantage of this type of IAC system is that power is required to maintain idle unlike the stepper motor type. Pulse width idle air control systems also require specific frequencies to operate.

For more information, go to [Idle](#) ²¹⁶

FCS (Fuel Composition Sensor)

The Fuel Composition Sensor (FCS) is used for "flex" fuel. These vehicles can run on a more environmental friendly ethanol based fuel which is commonly made from sugar cane or corn. It has roughly 30% less energy than standard pump gas, depending on the blend. E85 is the most common blend, which consists of 85% ethanol and 15% petroleum. This lack of energy does a couple things: It causes an increase in fuel consumption, but increases the air/fuel cooling characteristics as more fuel is required. Furthermore, ethanol has a much higher latency heat of evaporation than gasoline which also increases the cooling efficiency properties.



This information can then be used to add more injector pulse width, advance the ignition timing, and add boost pressure, if applicable.

For more information, go to [Flex Fuel](#)²³⁹

Fuel System Setup

Fuel Plumbing

Even with proper injector and fuel pump sizing, a fuel system will not flow adequately unless the hoses that deliver the fuel to the fuel rail are of sufficient size and are routed properly. On systems that use the PNP version of the AEM Infinity, there is no need to replace the fuel delivery hoses unless the engine is heavily modified.

NEVER route fuel hoses through the interior of a car. Put bluntly, this is a **dangerous** thing to do. Whenever possible, use a delivery tube to make the connection from the pump discharge to the filter in the front of the car. The lines should be rated to withstand at least twice the maximum pressure of the EFI system.

Using the above parameters of our sample engine with moderate boost, we expect to see pressures in the 65–70 psi range. This will require a line with at least 140-psi rating (most AN hoses exceed this by a large margin). When routing fuel lines, it is imperative that they are protected from road hazards and the exhaust system. The fuel line should **NEVER** be routed near battery cables. Use clamps to secure AN hose every 15 inches, or 24 inches if a rigid tube is used.

The following table will help you determine which hose size is correct for your application: These sizes are based on a nominal fuel pressure of 40 psi.

Fuel Delivery Hose Sizes

Gasoline Powered Engines

Up to 499 HP	.344" hose	-6 AN
500–799 HP	.437" hose	-8 AN
900–1100 HP	.562" hose	-10 AN

Methanol Engines

Up to 499 HP	.437" hose	-8 AN
500–799 HP	.562" hose	-10 AN
900–1100 HP	.687" hose	-12 AN

The above table should be used for typical passenger car applications. However, for custom applications the hose run length will affect fuel delivery. If you have a long hose run, then the actual flow will have to be determined by running the fuel pump into a graduated cylinder, then measuring the flow vs. time and calculating the flow in gallons per hour (g/h). Also note that if fuel banjos are used in the system be sure they have adequate fuel flow capability.

The fuel return hoses should be one size smaller than the delivery hose. For the sample engine described above, we would use a .437" (-8 AN) delivery hose and a .344" (-6 AN) return hose.

Before a fuel system is assembled in the vehicle, inspect for debris and damages. Make sure to have a fire extinguisher near by in case of fire when inspecting. After the fuel system is installed you must inspect the integrity of the entire system. Begin by purging the lines. To do this, run the fuel pump with the hose that connects to the fuel rail placed in a grounded container. This will eliminate any debris left in hose during its manufacturing

process. Inspect the fuel rail for cleanliness before starting the engine. Make sure that the fuel pressure is set correctly for your application. Then, reattach all of the hoses and run the fuel pump by switching the ignition to the "ON" position (**DO NOT** turn over the engine at this time), and visually inspect all of the connections for fuel seepage or leaks. If any seepage or leaks are present in the system, repair them before proceeding.

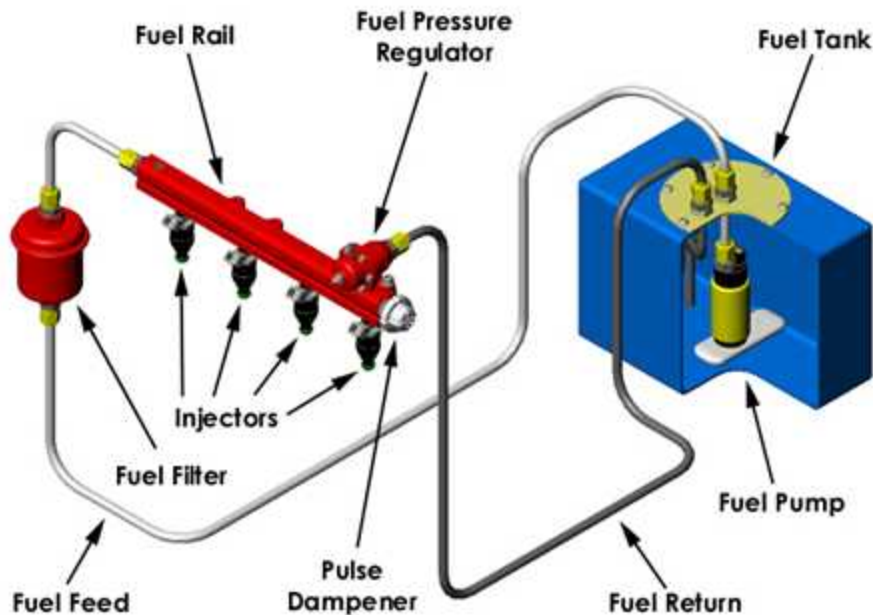

Fuel Pump

To achieve proper fuel delivery, you must select the right fuel pump for your vehicle. In most cases, where the engine has been modified only with "bolt on" performance items, there is rarely need for a larger fuel pump or larger injectors. Vehicle manufacturers typically design a "safety factor" into the fuel pump to accommodate the deterioration of the fuel system over time. This safety factor is intended to compensate for a fuel filter that is nearing the end its life, or for deposits in the injector orifice. Our research has revealed that generally there is about a 15%–20% oversize in most factory fuel pumps.



If the engine is enhanced via forced induction or nitrous oxide, the stock fuel pump is inadequate. **If the engine's power is increased more than 15–20% fuel delivery must increase as a factor of the power gain.**

The way to determine the proper-size fuel pump is based on the desired brake specific fuel consumption (BSFC) of the engine. This term refers to how much fuel in pounds per hour (pph) the engine consumes per horsepower and is a measure of the efficiency of the engine. It is a useful term in determining the total fuel requirement of the engine. On vehicles equipped with forced induction or nitrous oxide, higher BSFCs are required as an added measure of safety to prevent detonation or high combustion chamber temperatures. Below is a guide of BSFCs with standard CR that AEM uses for various engines that run on gasoline:

- Naturally Aspirated engines have a BSFC of .48 to .50.
- Forced Induction engines have a BSFC of .65 to .68.

Methanol (alcohol) powered engines require twice the amount of fuel, so the BSFCs are doubled.

Calculating the total fuel requirement of an engine requires simple equations that we outline in the following section. You must know how much power the engine is anticipated to make and we recommend that you guess on the high end. The fuel requirement will be determined in pounds per hour of fuel flow. Since most pumps are rated in gallons/hour you must know the weight of your fuel/gallon. (The vast majority of gasoline based fuels run at 7.25 lbs./gallon.) The equations to determine your fuel requirement is as follows:

- **(Power x BSFC) x (1 + Safety Margin) = pounds/hour**
- **Pounds/hour / 7.25 = gallons/hour**

An example of this equation is:

- 500 hp gasoline engine using moderate boost with a 30% safety margin
- $(500 \times .625) \times 1.30 = 406.25$ lbs/hr
- $406\text{lbs}/7.25 = 56$ gallons/hour
- If the pump that is being considered is rated in liters per hour, use the conversion factor of 3.785/gallon. The pump described above would be rated at 56 gallons \times 3.785 liters = 211.96 liters/hour.

In the fuel pump sizing, always use a safety margin greater than 20%.

The fuel pump should be located at a level that corresponds to the lowest part of the fuel tank. This does **NOT** mean that the pump should be in a vulnerable position such as hanging below the tank. The pump should also be positioned so that it is protected from the road hazards (speed bumps, curbs, road debris, etc.). In the event of an accident, the vehicle structure around the fuel pump should not deform to a point where the pump and its electrical connections are compromised.

The wiring for the fuel pump **MUST** be rated for the amperage of the pump. As with all high current wiring, a fuse rated for the amperage of the pump should be used. It is always better to err on the large side for the wire size. The ground for the pump must be the same size as the power lead and be mounted to a location that is clean and clear of any undercoating or paint.

Fuel Injector

A fuel injector is a valve that can be opened and closed very quickly. To open the valve, current must flow through a solenoid contained in the upper part of the injector assembly. The Infinity triggers the injector by providing a ground path to the negative terminal. Fused power is provided to the other terminal from the harness.



The Infinity is compatible with both high and low impedance injectors. To utilize the features of the Infinity's internal peak and hold injector drivers, low impedance injectors must be used to increase the current draw properly.

To determine the size of the injectors, the total engine power must be estimated or known. The fuel pump calculations and BSFC information mentioned in the [Fuel Pump](#)²⁹² section of this document provides a good understanding of the fuel requirements for an engine. The following equation will allow you to determine the requirements of your injectors:

$$\text{((Power x BSFC) x (1 + Safety Margin)) / Number of Injectors = pounds/hour}$$

An example of this equation is:

6 CYL. engine rated at 500 hp on gasoline using moderate boost with a 15% safety margin on the injector

$$500 \times .625 = 313 \text{ lbs}/6 = 52 \text{ lbs/hr/ injector. } 52 \times 1.15 = 60 \text{ lbs/hr/ injector}$$

If we take the flow of the injector (60 lbs/hr) and multiply it by the number of cylinders (6), we arrive at a total of 360 lbs/hr of flow. As you can see, the fuel pump described in the fuel pump sizing section referenced above has enough capacity to feed the engine with a little room to spare.

It is a good idea to know the maximum operating pressure of the fuel injectors. In some cases the fuel injector will not open if the fuel pressure exceeds the design limit of the injector. Also, at the higher pressures the injector fuel flow may become non-linear and cause inconsistent fuel delivery, usually creating a lean condition. Most injectors can withstand up to 70 psi. Many of the pintle style injectors can withstand higher pressure.

In the fuel injector sizing, always use a safety margin between 15–20%.

For more information, go to [Injector Setup](#)⁹⁰

Fuel Pressure Regulator

The fuel pressure regulator maintains a constant pressure across the fuel injector. The inlet manifold pressure varies with throttle angle, and engine speed. Small throttle angles and high engine speed produce low manifold pressure (high vacuum). While high throttle angles and low rpm give high manifold pressure. In addition to these conditions, low manifold pressure is associated with idle and high manifold pressure is at full throttle. It is the fuel pressure regulators job to keep a constant fuel pressure across the injector(s) regardless of manifold pressure.

Currently, there are several types of fuel pressure regulators in use. Many late model cars use a return-less system where the fuel pressure regulator is mounted in the fuel tank adjacent to the fuel pump (and therefore requires no return line back to the fuel tank). In most naturally aspirated applications these types of systems are adequate. With forced induction or heavily modified engines, an adjustable fuel pressure regulator with manifold vacuum reference must be fitted.

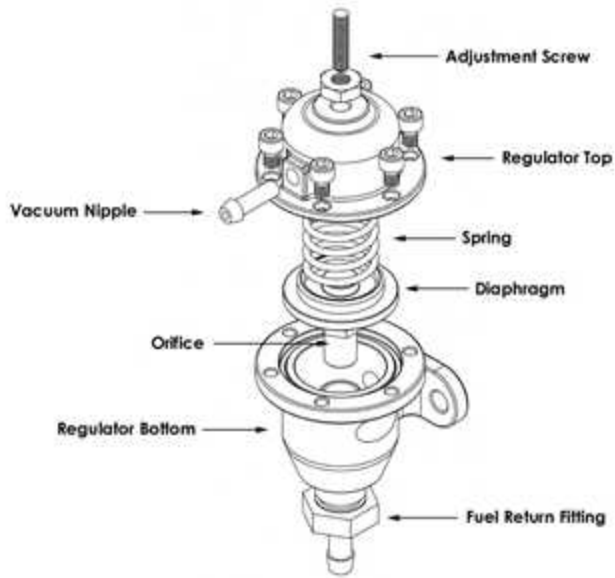

The two common types of fuel pressure regulators used are non-adjustable and adjustable. As the name implies, a non-adjustable regulator is set at a fixed value and is manifold-vacuum referenced (whenever a regulator is said to be vacuum referenced, this means that the inlet manifold vacuum/pressure is ported into the chamber above the regulator diaphragm).

As manifold pressure increases, the pressure in the top chamber of the pressure regulator increases along with it, allowing the regulator to compensate for the increased demand of the fuel delivery system.

Keep in mind that at idle or low throttle openings with high rpm, there is very low manifold pressure (vacuum). This tends to literally draw fuel from the injector. As manifold pressure increases (as the throttle is opened), this vacuum dissipates and it is harder for the fuel to discharge from the injector. The regulator reacts to the differences in manifold pressure to maintain constant fuel pressure across the injector. There is a spring in the vacuum (top) chamber of the fuel pressure regulator. The spring's pressure on the diaphragm determines the fuel system's static pressure. The system's static pressure is the amount of pressure measured with the vacuum hose disconnected or with the engine turned off. The fuel system's static pressure is higher than the fuel pressure at idle or under high vacuum conditions.

When the engine is running, the engine vacuum acts against the spring and the effect of the vacuum diminishes as the throttle is opened. At idle, there is a high amount of fuel returned to the tank because the vacuum is pulling the diaphragm seat off of the fuel return orifice, reducing fuel pressure. As the throttle is opened, the diaphragm seat starts to close off the orifice, restricting the amount of fuel flow through the return line.

An adjustable regulator allows the static pressure to be raised or lowered via an adjusting screw that acts on the diaphragm spring. On most adjustable regulators, when the screw is turned IN pressure raises and when it is turned OUT pressure is reduced. Although we highly recommend installing a proper fuel delivery system, raising or lowering fuel pressure *can* compensate for fuel injectors that may not be properly sized for an application.

Most aftermarket fuel pressure regulators (and OEM regulators) use a 1:1 ratio of fuel to boost pressure for increasing fuel pressure in applications where forced induction is used. This means that for every psi of boost, fuel pressure is increased one psi. This ensures adequate fuel delivery under boosted conditions.

For more information, go to [Fuel Pressure](#) ¹⁰²

Fuel Filter

Often overlooked in EFI installations, the fuel filter must have the capacity, filtering efficiency and burst strength to withstand the pressures of an EFI system. It must be able to flow the amount of fuel that matches the maximum fuel pump output. The filter is always located after the fuel pump, however it does not matter if it is positioned in the front or rear of the vehicle. (We prefer to put it toward the front for easy serviceability.) AEM carries fuel filters for high-powered engines, which use an easy to find, high volume, replaceable element.

It is imperative that a pre-filter be mounted to the fuel pick up in the tank. These filters are very high volume and create very little pressure drop. The use of a pre-filter ensures long fuel pump life and can eliminate low flow conditions caused by debris entering the pump inlet.



Fuel Rail

The fuel rail should be consistent with, or larger than, the hose size. The additional capacity of a large-diameter fuel rail helps to dampen the pulsations created by the fuel injectors and ensures even fuel delivery under all conditions.



Many vehicle manufacturers use a pulse dampener to reduce the pulsations in the fuel rail caused by the opening and closing of the injectors. (A dampener also reduces the noise of the injectors.) In applications where a new fuel system must be installed, a fuel pressure dampener is integral to ensuring consistent fuel flow to the injectors. AEM fuel rails have a provision for a pulse dampener. The dampener assembly part numbers are:

Honda PN:	16680-PE7-661	Dampener
Honda PN:	16705-PD1-003	Inner Gasket
Honda PN:	90428-PD6-003	Outer Gasket
AEM PN:	2-602	Fitting for Rail

Wiring, Pinouts and Schematics

Wiring

Wiring Conventions

A proper wiring job includes proper termination of the wire at the sensor. The wire terminal end must be moisture tight where it plugs into the sensor and it must have strong, electrically sound terminals. The preferred method of securing a wire to a terminal is to use a crimp terminal with NO solder. It is important to use the proper crimping tool for sound terminal construction. Plastic terminal plugs must have moisture tight seals. Inspect each plug to make sure the seals are in place. Also, before the plug is installed on the sensor, apply a dab of di-electric grease in the terminal slots to further aid in corrosion resistance.

If a splice into a wire must be made and no solder-less terminals are available, then you must properly solder the splice.

Noise can be a serious problem and can cause intermittent misfiring of the engine. Every precaution should be taken to prevent interference to the ECU's operation. Resistive plug leads are **REQUIRED**, and shielded cables from the crank and cam angle sensor inputs are highly recommended. All AEM Infinity wire harnesses come with

properly shielded cables and are color coded for easy identification of circuits. They are also shrink wrapped for abrasion protection. The crank and cam angle sensor wire has a bare wire running down the length of it. It is NOT terminated at the sensor end of the cable because we ground it at the plug end of the harness. **DO NOT GROUND THIS WIRE!** This will cause a condition called ground looping and will remove any noise protection the cable has.



To eliminate or reduce the chance of EMI, wires that carry high current must run in twisted pairs. An example of this would be the power leads from a multiple spark ignition system. These ignition systems can carry up to 100 amps for a couple milliseconds at the time of discharge, which induces a strong magnetic field in close proximity of the wires.

The routing of the wire loom is critical to EFI system performance and safety. The following safety considerations should be made when installing the wire loom:

- Heat protection: the loom should be placed away from or insulated from sources of heat. The obvious item(s) that should be avoided are the exhaust manifolds, EGR delivery tubes, and turbochargers. If it is absolutely necessary to route a wire in close proximity to any of these items, then a suitable insulator must be used.
- Noise suppression: do not route wires near the HT leads. For coil-on-plug ignition systems this is not as critical.
- Moving component protection: route wires away from moving components such as fans, the blower belt, or the throttle linkage. Also, make sure the wires are not under any strain when the engine is at full deflection on the motor mounts. (We have seen map sensor wires disconnect while under full acceleration because the motor mounts were bad.)
- Never have the wires in exposed bundles throughout the engine compartment. A professional harness has shrink tube over it to resist abrasion and chemical damage to the wire loom.

Tools

AEM recommends using the following proper crimp tool for all Infinity ECU terminations, **Molex Part No:** 63811-4200. This tool is available in many places. One is shown below. Web address: <http://www.newark.com>

Product Search

Find

[RoHS compliant](#) items only | [Advanced Search](#)

HOME | PRODUCTS | SERVICES | SOLUTIONS | COMMUNITY | ORDER | MY ACCOUNT |
LIVE SUPPORT ▾

[New to Newark/element14? Start here](#)

[HOME](#) > [Connectors](#) > [Accessories](#) > [Crimp Tools](#) > 63811-4200

MOLEX - 63811-4200 - HAND CRIMP TOOL

Customer Rating: ★★★★★ [Be the first one to review this product](#)

[Ask a question about this product](#)



Image is for illustrative purposes only. Please refer to product description.

molex

Manufacturer: [MOLEX](#)
Newark Part Number: 81H6890
Manufacturer Part No: 63811-4200

Availability

Availability: 1

1 available to ship today

▶ [Check more stock...](#)

Price For: 1 Each

Minimum Order Quantity: 1

Order Multiple Quantity: 1

Price: **\$360.06**

Qty

Buy

Qty	Price
1 - 4	\$360.06
5+	\$339.85

Product Information

- **HAND CRIMP TOOL**
- **Crimp Size:** 22AWG to 18AWG
- **For Use With:** 0,54mm Pitch MX64 Crimp Terminals
- **RoHS Compliant:** NA

A cheaper, but lower quality, alternative is the following crimp tool, **Molex Part No:** 63811-1000. This tool is available in many places. One is shown below. Web address: <http://www.newark.com>

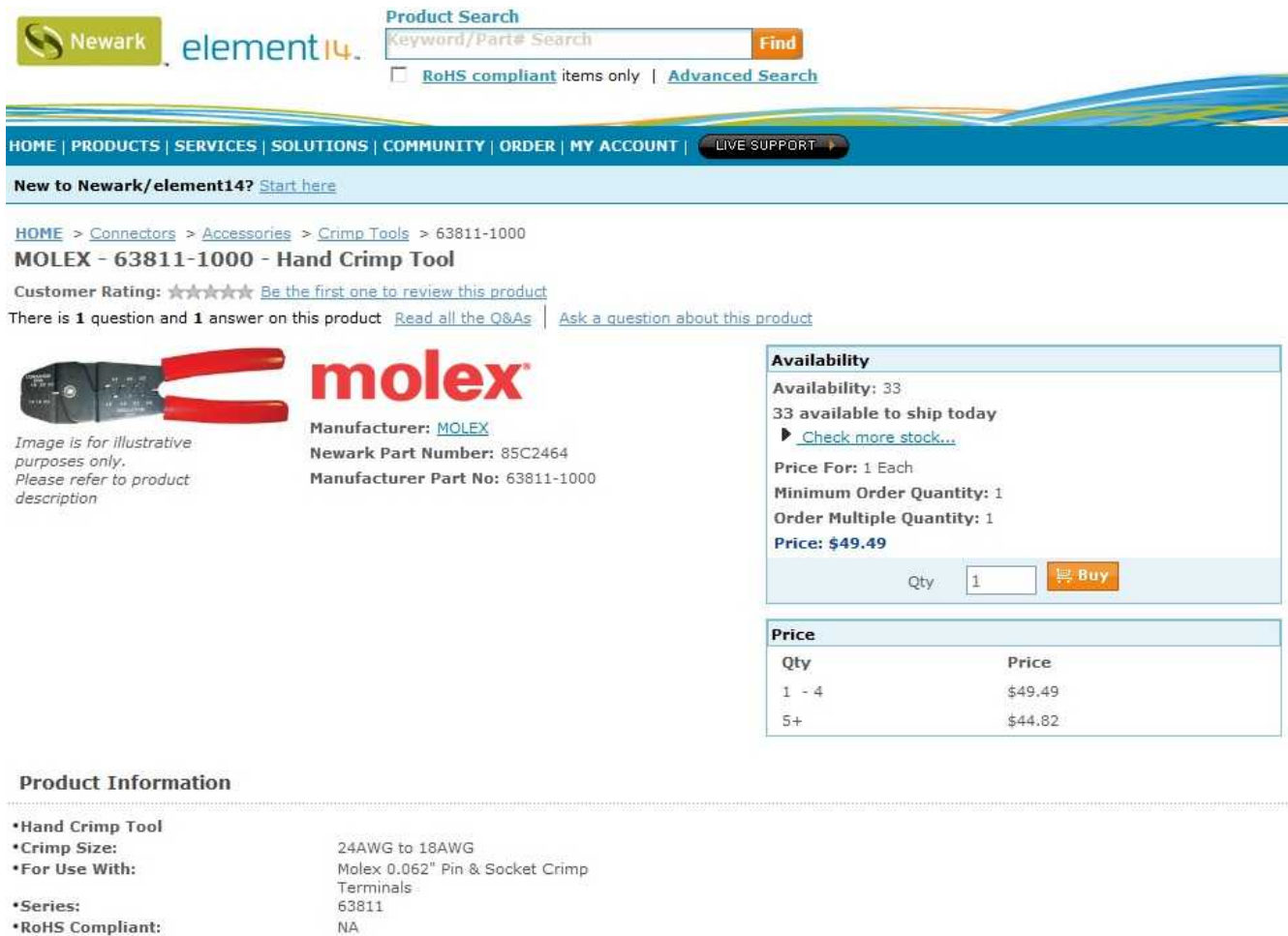

Product Search
 Keyword/Part# Search
 RoHS compliant items only | [Advanced Search](#)

HOME | PRODUCTS | SERVICES | SOLUTIONS | COMMUNITY | ORDER | MY ACCOUNT | LIVE SUPPORT

New to Newark/element14? [Start here](#)

HOME > Connectors > Accessories > Crimp Tools > 63811-1000
MOLEX - 63811-1000 - Hand Crimp Tool

Customer Rating: ★★★★★ [Be the first one to review this product](#)
 There is **1** question and **1** answer on this product [Read all the Q&As](#) | [Ask a question about this product](#)

 **molex**
 Manufacturer: [MOLEX](#)
 Newark Part Number: 85C2464
 Manufacturer Part No: 63811-1000

Image is for illustrative purposes only. Please refer to product description

Availability
 Availability: 33
 33 available to ship today

 Price For: 1 Each
 Minimum Order Quantity: 1
 Order Multiple Quantity: 1
 Price: **\$49.49**

Qty

Qty	Price
1 - 4	\$49.49
5+	\$44.82

Product Information

- Hand Crimp Tool
- Crimp Size: 24AWG to 18AWG
- For Use With: Molex 0.062" Pin & Socket Crimp Terminals
- Series: 63811
- RoHS Compliant: NA

Grounding

The Infinity must have an electrically secure ground connection, which means that the battery negative must be properly grounded to the chassis AND engine. The ground wire, whether it is from the battery or to the chassis and engine, must have perfect electrical conductivity. This means that there must not be any paint or rust under the wire terminal. Make sure to install the ground wire to contact bare/exposed metal of the vehicle component. To prevent rust build up, we recommend applying a protective layer of dielectric grease, such as Standard Ignition SL-4, to the bare metal surface. The ground wire must be **at least** the same gauge as the power lead to the ECU. AEM also recommends that the ground wire be as short as possible.

Power Requirements

The Infinity requires a minimum supply voltage of 10V or greater to run. We recommend that the Infinity be supplied with 13.8V nominal operating voltage. Ensure that the vehicle's charging system is in perfect operating condition prior to installing. Like most modern OEM ECUs, the Infinity requires a main relay for proper power distribution. Please refer [here](#)³³⁹ for Infinity-8/10/12 examples and [here](#)³³⁸ for Infinity-6/8h examples.

General Purpose Outputs

General purpose outputs (GPO) are one of the many things that separate a programmable ECU from a chipped or reflashed ECU. These outputs can be triggered for multiple actions based on engine speed, throttle position, engine load, coolant temperature, vehicle speed, etc.

Before proceeding, check the Application Notes included with your Infinity ECU to see which, if any, spare GPOs are available. Some vehicles will use more outputs than others. For instance, there are many outputs required to drive the various solenoids associated with an automatic transmission.

There are two types of GPOs: LowsideSwitch and HighsideSwitch outputs. The Infinity LowsideSwitch outputs a 4A (max) capable ground signal. The HighsideSwitch outputs a 0.7A (max) capable 12V signal.



The picture above depicts a HighsideSwitch output controlling a low current buzzer. This is similar to how a LowsideSwitch would be wired, except it would be connected to a 12V source instead of a ground lug ring terminal.

If the component being driven runs higher than the specified driver's capability, it is recommended to wire in a relay to the circuit.

Injectors

The Infinity ECU has integrated peak and hold injector drivers. This means the Infinity can drive high impedance or low impedance fuel injectors without using resistors to keep the current low. Note: With fuel injectors, polarity does not matter. This means the positive and negative wires can go on either injector pin.

AEM P/N 30-2020 (Optional)

This Bosch Style Injector Connector Kit contains the parts to assemble 4 injector connectors. The kit contains Four Bosch style female injector connectors and 10 contacts (2 extra contacts are included for spares).

IMPORTANT!

The contacts are "Pull to Seat" meaning you must feed the wire through the connector housing BEFORE you crimp on the contacts. The wire is then pulled back into the housing and the contact locks in place. The contact cannot be inserted or removed from the rear (wire side entry) of the housing.

Contacts (10 Included)

Plating	Tin Plated
Cable Range	1.00–0.05 mm ²

Outside Cable Diameter	2.40–2.03 mm ²
Temperature Range	-40 to 125 C
Resistance in mOhms at 20 mV	> 10.0 Ohms
Voltage Drop in mV per amp	> 3.0 Ohms

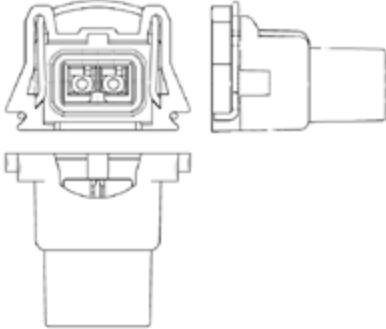
**Housing (4 Included)**

Color	Black
Cavities or Contacts	2
Gender	Female
Temperature Range	-40 to 125 C
Resistance at 20 mV	> 10.0 mOhm
Voltage Drop per amp	> 3.0 mV
Exterior Dimensions	27.8L X 29.6W X 20H
Seating Process	Pull To Seat

Ignition System

The diagram below illustrates a basic inductive ignition system setup with four independent ignition outputs (Coils 1–4).

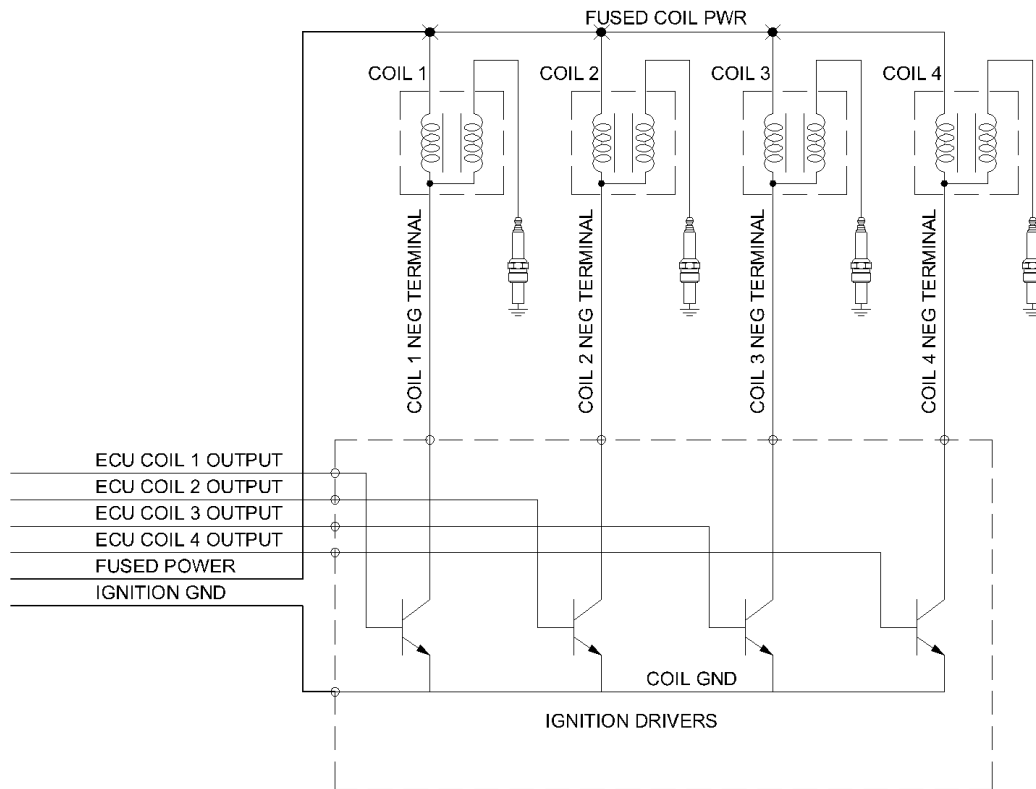

Transistors serve many functions but in this case they are applied as *Power Drivers*. The input circuit to the transistor from the ECU requires very little current flow to turn the transistor ON. When the transistor is ON, a high current capacity path is created between the coil negative terminal and ground. High current means more temperature to dissipate. A stand-alone ignition driver module or a driver module built into a coil assembly is designed to efficiently dissipate this heat. The more current flow, the more heat must be dissipated. The amount of current the drivers must sink to ground during each charge and fire event is determined by the *dwell time settings*. What is Dwell Time? The diagram below describes dwell time.

The process begins when the ECU sends a signal to the transistors turning on the current to the ignition coils primary winding. This 'charging' stores energy in the coils magnetic circuit. The current is then switched off. As the magnetic field begins to collapse the coil tries to resist the drop in current causing the voltage in the secondary winding to rise rapidly, this high voltage breaks down the air/fuel mixture in the spark gap allowing a spark to pass, causing ignition of the air/fuel mixture.

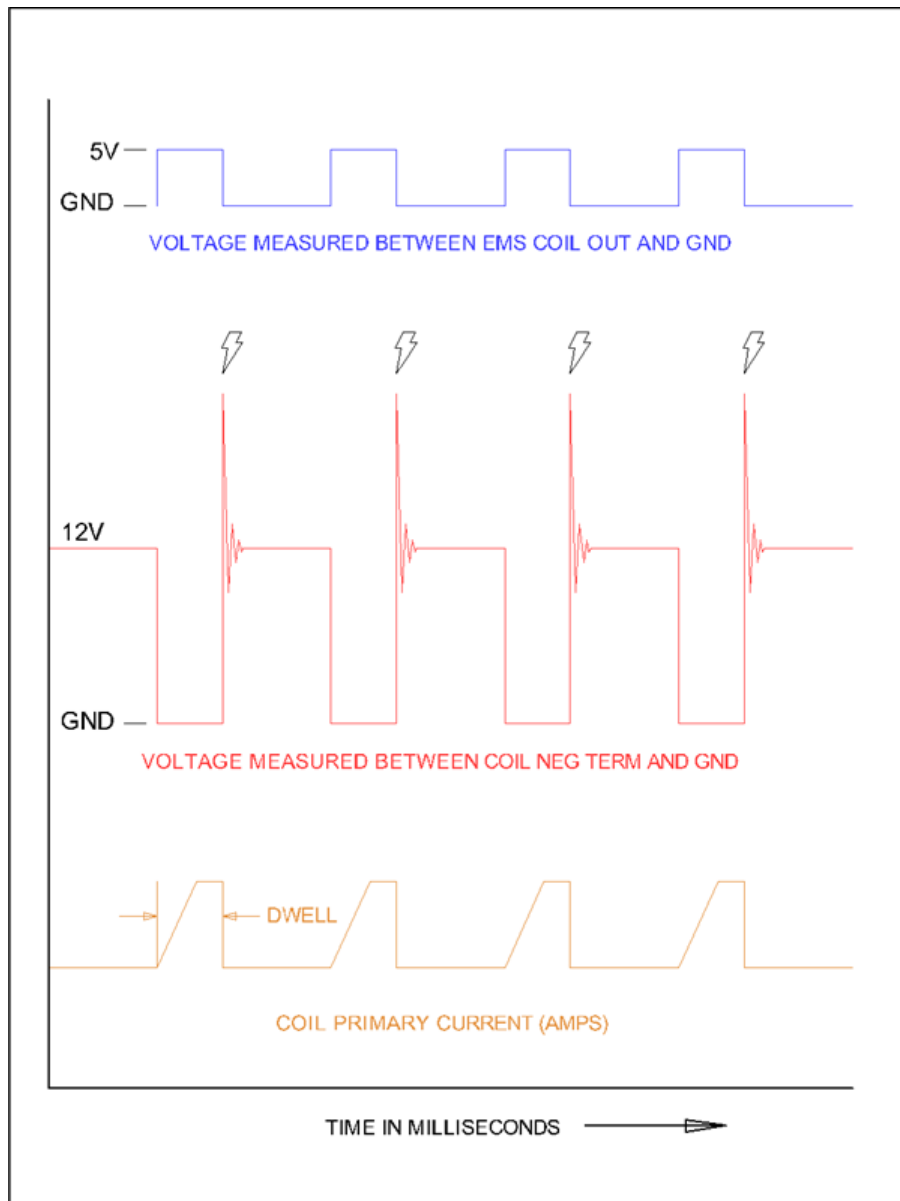

AEM P/N 30-2840 (Optional)

This Four Channel Coil Driver is custom manufactured to AEM's specifications by HÜCO Electronic GmbH in their ISO 9001 facility in Germany. It has been specially designed by AEM for driving the high power dwell controlled ignition coils commonly found on performance engines.

The 30-2840 Kit contains:

- Four Channel Coil Driver
- Five Pin Mating Connector
- Four Pin Mating Connector
- 10 Terminals & Wire seals (one extra of each as a precaution)
- Mounting hardware
- Thermal Grease

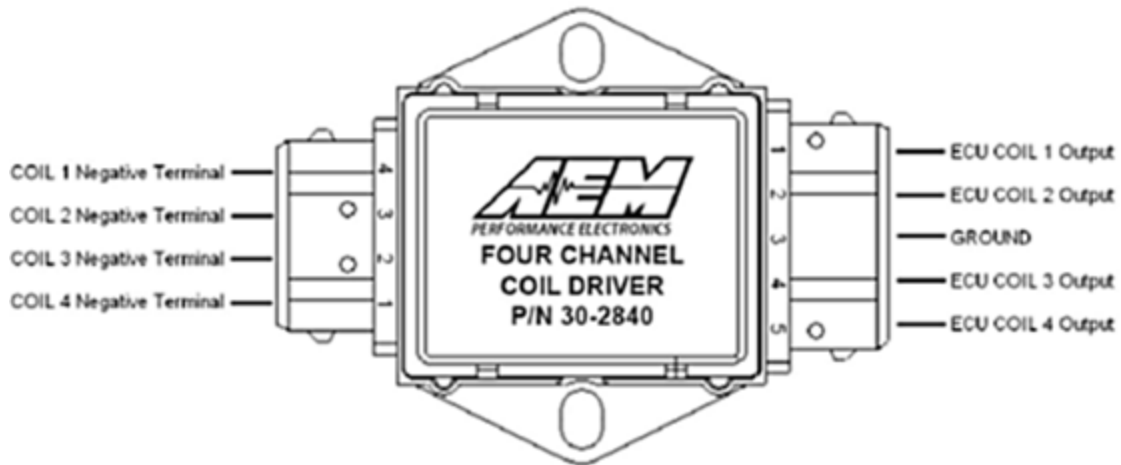

Four Channel Coil Driver Connections

Coil Driver	Connect to
ECU Coil 1 Output	Infinity harness, IGN 1
ECU Coil 2 Output	Infinity harness, IGN 2
ECU Coil 3 Output	Infinity harness, IGN 3
ECU Coil 4 Output	Infinity harness, IGN 4
Ground	Infinity harness, PWR GND
Coil 1 Negative Terminal	Coil 1 Negative Terminal
Coil 2 Negative Terminal	Coil 2 Negative Terminal
Coil 3 Negative Terminal	Coil 3 Negative Terminal
Coil 4 Negative Terminal	Coil 4 Negative Terminal

CDI Installations

The ignition outputs from the Infinity are considered a falling edge fire signal where signal high is dwell time. A coil driver will invert the signal from the Infinity pulling the signal low (ground) and allowing current to flow through the coil primary windings. Some CDI ignition boxes are only capable of triggering on the "rising edge" or "Points Trigger" signal. These systems will still require an in-line coil driver to invert the ignition output to fire on the correct edge. The AEM Twin Fire CDI system P/N 2820 (8 channel) and 2821 (4 channel) can be configured to fire on either a rising or falling edge. Applications using an AEM Twin Fire will not require an in-line coil driver. Contact your CDI manufacturer for more information.

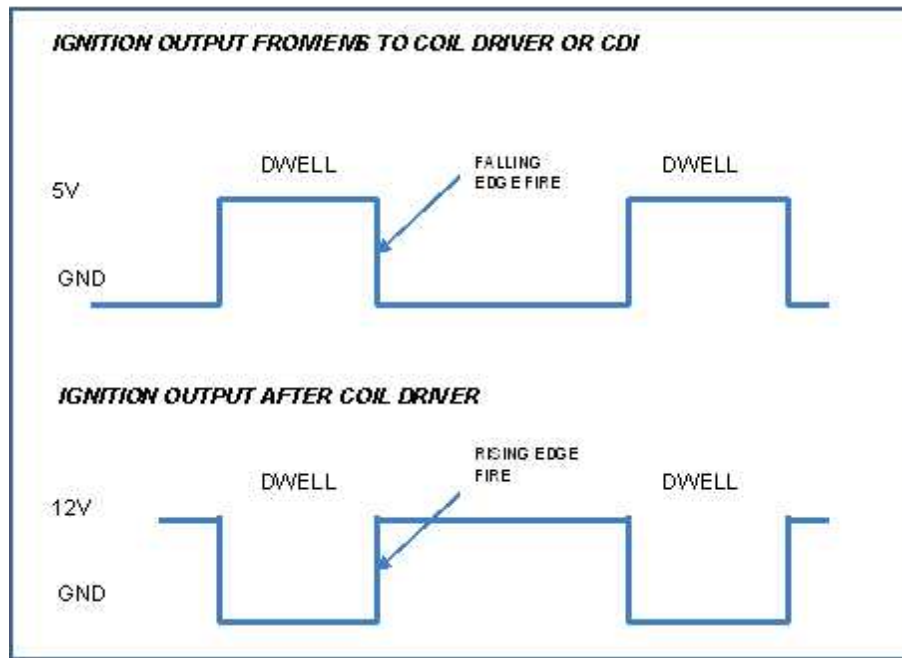

Signal comparison – before and after coil driver

Noise

Electrical noise can cause the Infinity ECU to see more tooth edges than there are in reality. This will result in excessive misfires during normal running. Misfire caused by “noise,” (commonly referred to as radio frequency interference {RFI}, or electro magnetic interference {EMI}), is usually due to routing the input signal leads in close proximity of the HT leads. Typically, spark plug wires cause RFI or primary ignition wires arcing to an engine component, which causes a frequency that interferes with the ECU. Routing two wires that carry high current parallel to each other cause EMI. The strength of current necessary to incur “noise” is dependent on the sensitivity of the device the wires are connected to. A common preventative measure for eliminating “noise” is to twist the wires together to minimize the electromagnetic field near the wires.

On any EFI system, resistive spark plug leads are REQUIRED to suppress noise! Common resistive spark plug leads include those with a carbon impregnated fiberglass core or spiral wound filament around a carbon core wire. Another source of noise that can cause a misfire is an electrical “leak” in a plug wire or boot. Even a very small pinhole in a spark plug insulator or boot will allow electricity to arc to the cylinder head and interfere with the ECU signal.

Sensors

MAP Sensor

Optional AEM MAP Sensor Listing:

AEM P/N 30-2130-30 “MAP Sensor Kit, 2 BAR”

Typically used to measure intake, air box and crankcase pressures

AEM P/N 30-2130-50 “MAP Sensor Kit, 3.5 BAR”

Typically used to measure intake & exhaust back pressures

AEM P/N 30-2130-75 “MAP Sensor Kit, 5 BAR”

Typically used to measure intake & exhaust back pressures



Red Wire: 5V Reference

Black Wire: Sensor Ground

Green Wire: MAP Signal

Air Temp Sensor

AEM P/N **30-2010 (Optional)** Air Temp Sensor kit is specifically designed for temperature measurements in automotive systems. The kit contains one GM style temperature sensor, one “6” Flying Lead” mating connector assembly, and a weld-in aluminum bung.

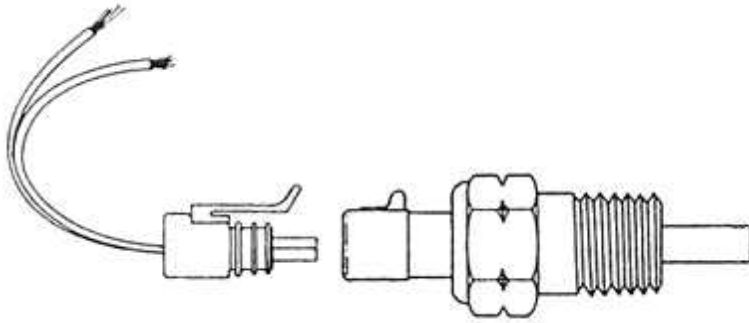

Housing Material: Brass with 3/8” NPT Thread (Torque to 25 Ft-Lbs)

Elec. Termination: Integral weatherproof connector, includes mating connector with 6” leads, 18 AWG

Wiring to the Infinity: Polarity does not matter. Connect one wire to harness AIR TEMP lead and the other to harness SIG GND lead.

Coolant Temp Sensor

AEM P/N **30-2011 (Optional)** Water Temp Sensor kit is specifically designed for temperature measurements in automotive systems. The kit contains one GM style temperature sensor, one “6” Flying Lead” mating connector assembly, and a weld-in aluminum bung.

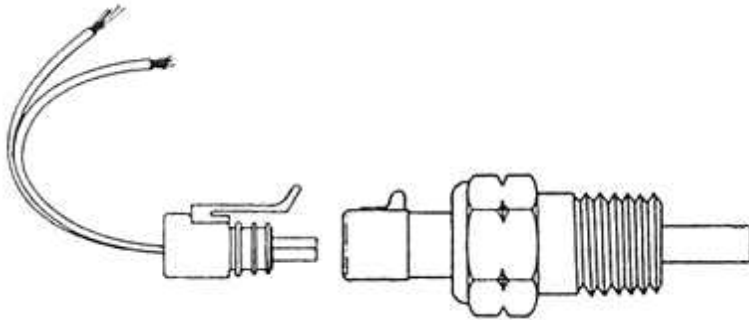

Housing Material: Brass with 3/8” NPT Thread (Torque to 25 Ft-Lbs)

Elec. Termination: Integral weatherproof connector, includes mating connector with 6” leads, 18 AWG

Wiring to the Infinity: Polarity does not matter. Connect one wire to harness COOLANT lead and the other to harness SIG GND lead.

Crank Sensor

The crank sensor is used to calculate engine speed, ignition timing and injection phasing angles. Shown below, it senses a toothed wheel (reluctor wheel, reluctor ring, etc.) and converts this pattern into a voltage/frequency signal that the Infinity uses for basic calculations.



Either on its own, or combined with the cam position sensor, it is the most important input to the system. There are two basic types of crank sensors, variable reluctance (VR or "mag") and hall-effect.



VR Sensor Voltage Signal

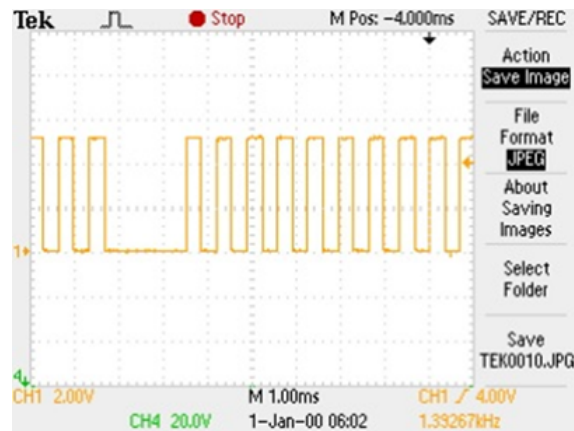

Hall Effect Voltage Signal

The internal circuitry on the Infinity is different depending on what type of sensor is being used. Note that there are two different inputs on the Infinity for crank and cam position: one for a Hall Effect type pickup and the other for a VR or “mag” pickup. The Infinity crank sensor VR inputs go through a signal conditioning chip on the circuit board that converts the raw (zero crossing) signal into a clean 0–5V square wave signal as shown below.

Cam Sensor

The cam sensor is typically very similar to the crank sensor but is used to calculate engine position. It is necessary for sequential fuel calculations. It senses a toothed wheel (reluctor wheel, reluctor ring, etc.) and converts this pattern into a voltage/frequency signal that the Infinity uses for basic calculations. Combined with the crank position sensor, it is one of the most important inputs to the system. There are two basic types of cam sensors, variable reluctance (VR or “mag”) and hall-effect. The oscilloscope frequencies are similar to the crank sensor shown above but typically with less pulses (teeth).

Shown below is a cam and crank sensor that integrates into one AEM trigger wheel (24 and 1). The perimeter has 24 crank teeth. The 1 long tooth is used for the cam sensor.



Vehicle Speed Sensor (VSS)

The vehicle speed sensor can be VR or a hall-effect device. It is similar in function and wiring as the cam and crank sensor but instead is used to detect wheel speed. This input is used for various Infinity software functions. There

are two basic types of vehicle speed sensors, variable reluctance (VR or “mag”) and hall-effect.

Shown below is a Nissan vehicle speed sensor.



Digital Switch Inputs

Common digital switch inputs used in electronic fuel injection applications are oil pressure switches, clutch switches, A/C request input, hi/lo boost switch, race gas switch, etc.

A quality SPST (single pole single throw) switch works best for basic switch inputs .

Find a good ground source near the switch mounting location. If there is oil, rust, paint, etc., present, use a wire brush to clean the area for a proper connection. Most ground connections are used with a ring terminal (as shown below). Route one of the switch terminal to this ground point.

In the [Infinity-8/10/12 pinout](#) ³¹⁵ or [Infinity-6/8h pinout](#) ³²⁶, find an available unused Digital_In_X input on your specific Infinity. Route the other terminal of the switch to this Infinity ECU pin. Some special purpose pins will not work with a ground switch. Specifically, pins C2-37 and C2-38 on the Infinity-8/10/12 platforms are designed to be floating and require a 12V input for activation.



Auxiliary Connector

Most Infinity PnP Harnesses include a 12pin "auxiliary" Deutsch connector. This male pinned connector is used to adapt the most common ancillary inputs and outputs easily. See application specific user manual documentation for details.

Idle Air Control Valve Requirements

Many Toyota, Mitsubishi, and other vehicles use an Idle Air Control Valve with a Unipolar Stepper Motor (6-pin connector) and **MUST** be modified. See picture below. A Bipolar Stepper Motor (e.g., GM) will have a 4-pin connector and **DOES NOT** need to be modified. *This info does not apply to vehicles that utilize IACV solenoids.



The 2 center pins (Black-Red wires) supply 12V power to the stepper motor in the factory setup, however these pins **MUST BE DISCONNECTED** before powering on the AEM Infinity ECU.



Step 1: Disconnect connector from IACV housing and gently remove the retainer from the connector.

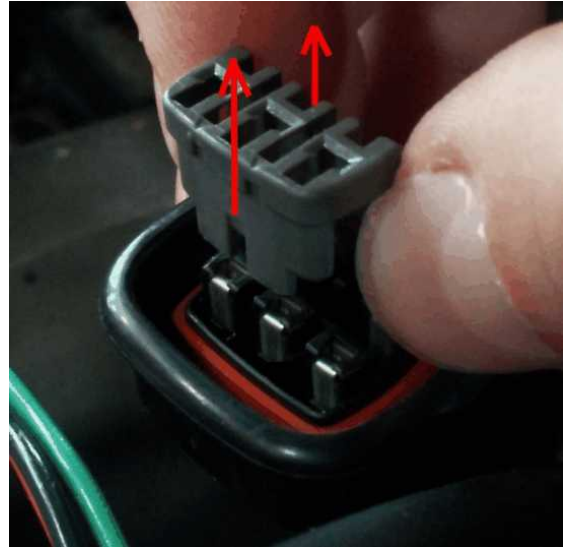

Step 2: Use a small flat-blade screwdriver/pick to move the terminal locks while pulling the Black-Red wires out from the backside of the connector.

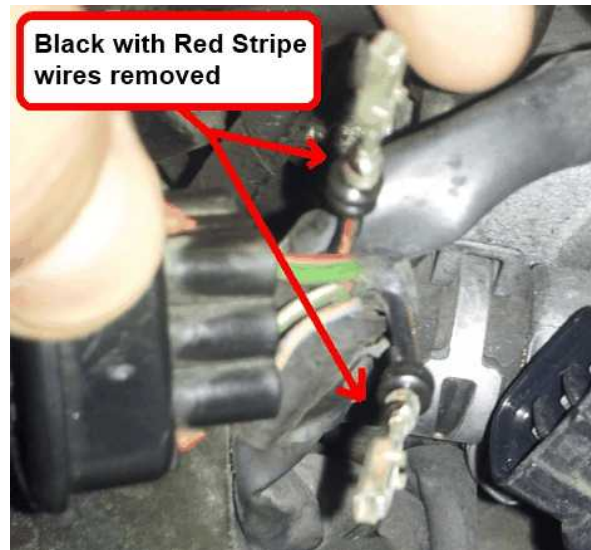

Step 3: Use heat shrink to insulate both 12V wires and then zip-tie the insulated wires to a nearby loom.

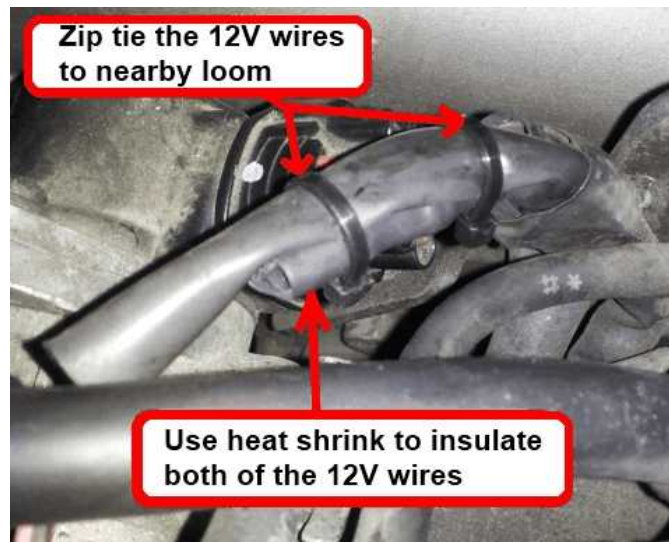

Step 4: Reinstall the retainer, and then plug the connector back into the IACV.

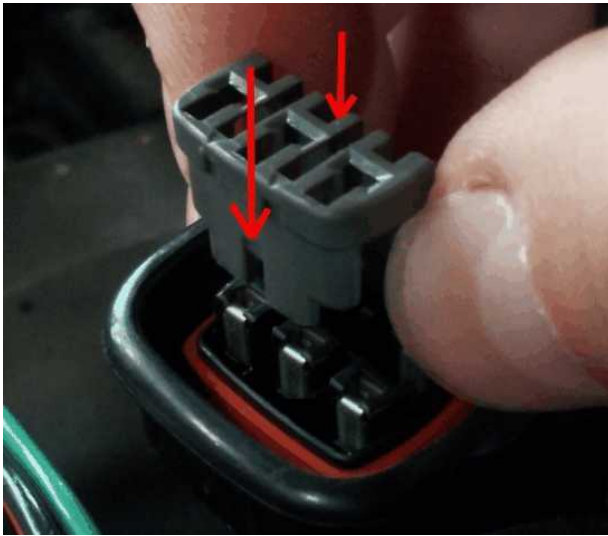

Universal Pinout, Infinity-8/10/12

Infinity Pin	Hrdwr Ref.	Hardware Specification	Notes
C1-1	Lowside 4	Lowside switch, 4A max, NO internal flyback diode. No pullup	See Setup Wizard Page "Output Function Assignment" for setup options.

Infinity Pin	Hrdwr Ref.	Hardware Specification	Notes
C1-2	Lowside 5	Lowside switch, 4A max with internal flyback diode. Inductive load should NOT have full time power. No pullup	See Setup Wizard Page "Output Function Assignment" for setup options.
C1-3	Lowside 6	Lowside switch, 4A max with internal flyback diode. Inductive load should NOT have full time power. No pullup	See Setup Wizard Page "Output Function Assignment" for setup options.
C1-4	UEGO 1 Heat	Bosch UEGO controller	Lowside switch for UEGO heater control. Connect to pin 4 of Bosch UEGO sensor. NOTE that pin 3 of the Sensor is heater (+) and must be power by a fused/switched 12V supply.
C1-5	UEGO 1 IA		Trim Current signal. Connect to pin 2 of Bosch UEGO sensor
C1-6	UEGO 1 IP		Pumping Current signal. Connect to pin 6 of Bosch UEGO sensor
C1-7	UEGO 1 UN		Nernst Voltage signal. Connect to pin 1 of Bosch UEGO sensor
C1-8	UEGO 1 VM		Virtual Ground signal. Connect to pin 5 of Bosch UEGO sensor.
C1-9	Flash Enable	10K pulldown	Not usually needed for automatic firmware updates through Infinity Tuner. If connection errors occur during update, connect 12 volts to this pin before proceeding with upgrade. Disconnect the 12 volts signal after the update.
C1-10	Battery Perm Power	Dedicated power management CPU	Full time battery power. MUST be powered before the ignition switch input is triggered (See C1-65).
C1-11	Coil 4	25 mA max source current	0-5V Falling edge fire. DO NOT connect directly to coil primary. Must use an ignitor OR CDI that accepts a FALLING edge fire signal.
C1-12	Coil 3	25 mA max source current	0-5V Falling edge fire. DO NOT connect directly to coil primary. Must use an ignitor OR CDI that accepts a FALLING edge fire signal.

Infinity Pin	Hrdwr Ref.	Hardware Specification	Notes
C1-13	Coil 2	25 mA max source current	0-5V Falling edge fire. DO NOT connect directly to coil primary. Must use an ignitor OR CDI that accepts a FALLING edge fire signal.
C1-14	Coil 1	25 mA max source current	0-5V Falling edge fire. DO NOT connect directly to coil primary. Must use an ignitor OR CDI that accepts a FALLING edge fire signal.
C1-15	Coil 6	25 mA max source current	0-5V Falling edge fire. DO NOT connect directly to coil primary. Must use an ignitor OR CDI that accepts a FALLING edge fire signal.
C1-16	Coil 5	25 mA max source current	0-5V Falling edge fire. DO NOT connect directly to coil primary. Must use an ignitor OR CDI that accepts a FALLING edge fire signal.
C1-17	Lowside 2	Lowside switch, 4A max, NO internal flyback diode. No pullup	See Setup Wizard Page "Output Function Assignment" for setup options.
C1-18	Lowside 3	Lowside switch, 4A max with internal flyback diode. Inductive load should NOT have full time power. No pullup	See Setup Wizard Page "Output Function Assignment" for setup options.
C1-19	Analog Sensor Ground	Dedicated analog ground	Analog 0-5V sensor ground
C1-20	Analog Sensor Ground	Dedicated analog ground	Analog 0-5V sensor ground
C1-21	Crankshaft Position Sensor Hall	10K pullup to 12V. Will work with ground or floating switches.	See Setup Wizard page Cam/Crank for options.
C1-22	Camshaft Position Sensor 1 Hall	10K pullup to 12V. Will work with ground or floating switches.	See Setup Wizard page Cam/Crank for options.
C1-23	Digital 2	10K pullup to 12V. Will work with ground or floating switches.	See Setup Wizard page Cam/Crank for options.

Infinity Pin	Hrdwr Ref.	Hardware Specification	Notes
C1-24	Digital 3	10K pullup to 12V. Will work with ground or floating switches.	See Setup Wizard page "Input Function Assignments" for setup options.
C1-25	Digital 4	10K pullup to 12V. Will work with ground or floating switches.	See Setup Wizard page "Input Function Assignments" for setup options.
C1-26	Digital 5	10K pullup to 12V. Will work with ground or floating switches.	See Setup Wizard page "Input Function Assignments" for setup options.
C1-27	Knock Sensor 1	Dedicated knock signal processor	See Setup Wizard page Knock Setup for options.
C1-28	Knock Sensor 2	Dedicated knock signal processor	See Setup Wizard page Knock Setup for options.
C1-29	EFI Main Relay Switched Ground Output	0.7A max ground sink for external relay control	Will activate at key on and at key off according to the configuration settings.
C1-30	Battery Ground	Battery Ground	Connect directly to battery ground
C1-31	CANL A	Dedicated High Speed CAN Transceiver	Recommend twisted pair (one twist per 2") with terminating resistor. Contact AEM for additional information.
C1-32	CANH A	Dedicated High Speed CAN Transceiver	Recommend twisted pair (one twist per 2") with terminating resistor. Contact AEM for additional information.
C1-33	Lowside 1	Lowside switch, 4A max with internal flyback diode. Inductive load should NOT have full time power. No pullup	See Setup Wizard Page "Output Function Assignment" for setup options.
C1-34	Lowside 0	Lowside switch, 4A max, NO internal flyback diode. No pullup	See Setup Wizard Page "Output Function Assignment" for setup options.
C1-35	Analog 7	12 bit A/D, 100K pullup to 5V	Default primary Throttle Position input. 0-5V analog signal. Use +5V Out pins as power supply and Sensor Ground pins as the low reference. Do not connect signals referenced to +12V as this can permanently damage the ECU. See the

Infinity Pin	Hrdwr Ref.	Hardware Specification	Notes
			Setup Wizard Set Throttle Range page for automatic min/max calibration.
C1-36	Analog 8	12 bit A/D, 100K pullup to 5V	Default Manifold Pressure Input. 0-5V analog signal. Use +5V Out pins as power supply and Sensor Ground pins as the low reference. Do not connect signals referenced to +12V as this can permanently damage the ECU.
C1-37	Analog 9	12 bit A/D, 100K pullup to 5V	Default Fuel Pressure Input. 0-5V analog signal. Use +5V Out pins as power supply and Sensor Ground pins as the low reference. Do not connect signals referenced to +12V as this can permanently damage the ECU.
C1-38	Analog 10	12 bit A/D, 100K pullup to 5V	0-5V analog signal. Use +5V Out pins as power supply and Sensor Ground pins as the low reference. Do not connect signals referenced to +12V as this can permanently damage the ECU. See the Setup Wizard "Input Function Assignments" page for options.
C1-39	Analog 11	12 bit A/D, 100K pullup to 5V	0-5V analog signal. Use +5V Out pins as power supply and Sensor Ground pins as the low reference. Do not connect signals referenced to +12V as this can permanently damage the ECU. See the Setup Wizard "Input Function Assignments" page for options.
C1-40	Analog 12	12 bit A/D, 100K pullup to 5V	0-5V analog signal. Use +5V Out pins as power supply and Sensor Ground pins as the low reference. Do not connect signals referenced to +12V as this can permanently damage the ECU. See the Setup Wizard "Input Function Assignments" page for options.
C1-41	+5V Sensor Power	Regulated, fused +5V supply for sensor power	Analog sensor power
C1-42	+5V Sensor Power	Regulated, fused +5V supply for sensor power	Analog sensor power

Infinity Pin	Hrdwr Ref.	Hardware Specification	Notes
C1-43	Highside 1	0.7A max, High Side Solid State Relay	See Setup Wizard page "Output Function Assignment" for configuration options.
C1-44	Highside 0	0.7A max, High Side Solid State Relay	See Setup Wizard page "Output Function Assignment" for configuration options.
C1-45	Crankshaft Position Sensor VR+	Differential Variable Reluctance Zero Cross Detection	See Setup Wizard page Cam/Crank for options.
C1-46	Crankshaft Position Sensor VR-		See Setup Wizard page Cam/Crank for options.
C1-47	Camshaft Position Sensor 1 VR-	Differential Variable Reluctance Zero Cross Detection	See Setup Wizard page Cam/Crank for options.
C1-48	Camshaft Position Sensor 1 VR+		See Setup Wizard page Cam/Crank for options.
C1-49	VR+ 2	Differential Variable Reluctance Zero Cross Detection	See the Setup Wizard "Input Function Assignments" page for options.
C1-50	VR- 2		
C1-51	VR- 3	Differential Variable Reluctance Zero Cross Detection	See the Setup Wizard "Input Function Assignments" page for options.
C1-52	VR+ 3		
C1-53	DBW1 Motor -	5.0A max Throttle Control Hbridge Drive	+12V to close.
C1-54	DBW1 Motor +	5.0A max Throttle Control Hbridge Drive	+12V to open.
C1-55	Battery Ground	Power Ground	Connect directly to battery ground
C1-56	Injector 6	Saturated or peak and hold, 3A max continuous	Injector 6
C1-57	Injector 5	Saturated or peak and hold, 3A max continuous	Injector 5
C1-58	Injector 4	Saturated or peak and hold, 3A max continuous	Injector 4
C1-59	Injector 3	Saturated or peak and hold, 3A max continuous	Injector 3
C1-60	Battery Ground	Power Ground	Connect directly to battery ground

Infinity Pin	Hrdwr Ref.	Hardware Specification	Notes
C1-61	Main Relay Power Input	12 volt power from relay	12 volt power from relay. Relay must be controlled by EFI Main Relay Switched Ground Output, pin C1-29 above.
C1-62	Injector 2	Saturated or peak and hold, 3A max continuous	Injector 2
C1-63	Injector 1	Saturated or peak and hold, 3A max continuous	Injector 1
C1-64	Main Relay Power Input	12 volt power from relay	12 volt power from relay. Relay must be controlled by +12V Relay Control signal pin C1-29 above.
C1-65	Ignition Switch	10K pulldown	Full time battery power must be available at C1-10 before this input is triggered.
C1-66	Analog Temp 1	12 bit A/D, 2.49K pullup to 5V	Default Coolant Temperature Input.
C1-67	Analog Temp 2	12 bit A/D, 2.49K pullup to 5V	Default Air Temperature Input.
C1-68	Analog Temp 3	12 bit A/D, 2.49K pullup to 5V	Normally used for Oil Temp input. See the Setup Wizard "Input Function Assignments" page for options.
C1-69	Stepper 2A	Automotive, Programmable Stepper Driver, up to 28V and $\pm 1.4A$	Be sure that each internal coil of the stepper motor are properly paired with the 1A/1B and 2A/2B ECU outputs. Supports Bi-Polar stepper motors only.
C1-70	Stepper 1A	Automotive, Programmable Stepper Driver, up to 28V and $\pm 1.4A$	Be sure that each internal coil of the stepper motor are properly paired with the 1A/1B and 2A/2B ECU outputs. Supports Bi-Polar stepper motors only.
C1-71	Stepper 2B	Automotive, Programmable Stepper Driver, up to 28V and $\pm 1.4A$	Be sure that each internal coil of the stepper motor are properly paired with the 1A/1B and 2A/2B ECU outputs. Supports Bi-Polar stepper motors only.
C1-72	Stepper 1B	Automotive, Programmable Stepper Driver, up to 28V and $\pm 1.4A$	Be sure that each internal coil of the stepper motor are properly paired with the 1A/1B and 2A/2B ECU outputs. Supports Bi-Polar stepper motors only.
C1-73	Battery Ground	Battery Ground	Connect directly to battery ground
C2-1	DBW2 Motor +	5.0A max Throttle Control Hbridge Drive	+12V to open.

Infinity Pin	Hrdwr Ref.	Hardware Specification	Notes
C2-2	DBW2 Motor -	5.0A max Throttle Control Hbridge Drive	+12V to close.
C2-3	Battery Ground	Battery Ground	Connect directly to battery ground
C2-4	Injector 7	Saturated or peak and hold, 3A max continuous	Injector 7
C2-5	Injector 8	Saturated or peak and hold, 3A max continuous	Injector 8
C2-6	Injector 9	Saturated or peak and hold, 3A max continuous	Injector 9.
C2-7	Injector 10	Saturated or peak and hold, 3A max continuous	Injector 10.
C2-8	Battery Ground	Power Ground	Connect directly to battery ground.
C2-9	Main Relay Power Input	12 volt power from relay	12 volt power from relay. Relay must be controlled by +12V Relay Control signal, pin C1-29 above.
C2-10	Injector 11	Saturated or peak and hold, 3A max continuous	Not used
C2-11	Injector 12	Saturated or peak and hold, 3A max continuous	Not used
C2-12	Analog 17	12 bit A/D, 100K pullup to 5V	0-5V analog signal. Use +5V Out pins as power supply and Sensor Ground pins as the low reference. Do not connect signals referenced to +12V as this can permanently damage the ECU. Normally used as A/C Analog Request input. See the Setup Wizard "Input Function Assignments" page for options.
C2-13	Analog 18	12 bit A/D, 100K pullup to 5V	0-5V analog signal. Use +5V Out pins as power supply and Sensor Ground pins as the low reference. Do not connect signals referenced to +12V as this can permanently damage the ECU. Normally used as DBW APP1. See the Setup Wizard "Input Function Assignments" page for options.

Infinity Pin	Hrdwr Ref.	Hardware Specification	Notes
C2-14	Analog 19	12 bit A/D, 100K pullup to 5V	0-5V analog signal. Use +5V Out pins as power supply and Sensor Ground pins as the low reference. Do not connect signals referenced to +12V as this can permanently damage the ECU. Normally used as DBW APP2. See the Setup Wizard "Input Function Assignments" page for options.
C2-15	Analog Temp 4	12 bit A/D, 2.49K pullup to 5V	Normally used as Charge Out Temperature input. See the Setup Wizard "Input Function Assignments" page for options.
C2-16	Analog Temp 5	12 bit A/D, 2.49K pullup to 5V	Normally used as Airbox Temperature input. See the Setup Wizard "Input Function Assignments" page for options.
C2-17	Analog Temp 6	12 bit A/D, 2.49K pullup to 5V	Normally used as Fuel Temperature input. See the Setup Wizard "Input Function Assignments" page for options.
C2-18	Analog 13	12 bit A/D, 100K pullup to 5V	Default Oil Pressure sensor input. 0-5V analog signal. Use +5V Out pins as power supply and Sensor Ground pins as the low reference. Do not connect signals referenced to +12V as this can permanently damage the ECU.
C2-19	Analog 14	12 bit A/D, 100K pullup to 5V	0-5V analog signal. Use +5V Out pins as power supply and Sensor Ground pins as the low reference. Do not connect signals referenced to +12V as this can permanently damage the ECU. See the Setup Wizard "Input Function Assignments" page for options.
C2-20	Analog 15	12 bit A/D, 100K pullup to 5V	Default Exhaust Backpressure Sensor Input 0-5V analog signal. Use +5V Out pins as power supply and Sensor Ground pins as the low reference. Do not connect signals referenced to +12V as this can permanently damage the ECU. See the Setup Wizard "Input Function Assignments" page for options.

Infinity Pin	Hrdwr Ref.	Hardware Specification	Notes
C2-21	Analog 16	12 bit A/D, 100K pullup to 5V	Default DBW1_TPSB input. 0-5V analog signal. Use +5V Out pins as power supply and Sensor Ground pins as the low reference. Do not connect signals referenced to +12V as this can permanently damage the ECU.
C2-22	+5V Sensor Power	Regulated, fused +5V supply for sensor power	Analog sensor power
C2-23	+5V Sensor Power	Regulated, fused +5V supply for sensor power	Analog sensor power
C2-24	+5V Sensor Power	Regulated, fused +5V supply for sensor power	Analog sensor power
C2-25	VR+ 5	Differential Variable Reluctance Zero Cross Detection	See the Setup Wizard "Input Function Assignments" page for options.
C2-26	VR- 5		
C2-27	VR- 4	Differential Variable Reluctance Zero Cross Detection	See the Setup Wizard "Input Function Assignments" page for options.
C2-28	VR+ 4		
C2-29	Lowside 9	Lowside switch, 4A max with internal flyback diode, 2.2K 12V pullup. Inductive load should NOT have full time power. 12V pullup	See Setup Wizard Page "Output Function Assignment" for setup options.
C2-30	Analog Sensor Ground	Dedicated analog ground	Analog 0-5V sensor ground
C2-31	Analog Sensor Ground	Dedicated analog ground	Analog 0-5V sensor ground
C2-32	Analog Sensor Ground	Dedicated analog ground	Analog 0-5V sensor ground

Infinity Pin	Hrdwr Ref.	Hardware Specification	Notes
C2-33	Analog 20	12 bit A/D, 100K pullup to 5V	0-5V analog signal. Use +5V Out pins as power supply and Sensor Ground pins as the low reference. Do not connect signals referenced to +12V as this can permanently damage the ECU.
C2-34	Analog 21	12 bit A/D, 100K pullup to 5V	0-5V analog signal. Use +5V Out pins as power supply and Sensor Ground pins as the low reference. Do not connect signals referenced to +12V as this can permanently damage the ECU. Normally used as 3 Step Enable Switch input. See the Setup Wizard "Input Function Assignments" page for options.
C2-35	Analog 22	12 bit A/D, 100K pullup to 5V	0-5V analog signal. Use +5V Out pins as power supply and Sensor Ground pins as the low reference. Do not connect signals referenced to +12V as this can permanently damage the ECU. See the Setup Wizard "Input Function Assignments" page for options.
C2-36	Analog 23	12 bit A/D, 100K pullup to 5V	Default Charge Out Pressure Sensor Input 0-5V analog signal. Use +5V Out pins as power supply and Sensor Ground pins as the low reference. Do not connect signals referenced to +12V as this can permanently damage the ECU. See the Setup Wizard "Input Function Assignments" page for options.
C2-37	Digital 6	No pullup. Accepts 12V switch inputs	Input can be assigned to different pins. See Setup Wizard page Input Function Assignments for input mapping options.
C2-38	Digital 7	No pullup. Accepts 12V switch inputs	See ClutchSwitch 1-axis table for setup options. Input can be assigned to different pins. See Setup Wizard page Input Function Assignments for input mapping options.
C2-39	Battery Ground	Battery Ground	Connect directly to battery ground
C2-40	Battery Ground	Battery Ground	Connect directly to battery ground
C2-41	CanH B	Dedicated High Speed CAN Transceiver	Not used

Infinity Pin	Hrdwr Ref.	Hardware Specification	Notes
C2-42	CanL B	Dedicated High Speed CAN Transceiver	Not used
C2-43	Lowside 8	Lowside switch, 4A max with internal flyback diode. Inductive load should NOT have full time power. 12V pullup	See Setup Wizard Page "Output Function Assignment" for setup options.
C2-44	Lowside 7	Lowside switch, 4A max with internal flyback diode. Inductive load should NOT have full time power. No pullup	See Setup Wizard Page "Output Function Assignment" for setup options.
C2-45	UEGO 2 VM	Bosch UEGO Controller	Virtual Ground signal. Connect to pin 5 of Bosch UEGO sensor.
C2-46	UEGO 2 UN		Nernst Voltage signal. Connect to pin 1 of Bosch UEGO sensor
C2-47	UEGO 2 IP		Pumping Current signal. Connect to pin 6 of Bosch UEGO sensor
C2-48	UEGO 2 IA		Trim Current signal. Connect to pin 2 of Bosch UEGO sensor
C2-49	UEGO 2 HEAT		Lowside switch for UEGO heater control. Connect to pin 4 of Bosch UEGO sensor. NOTE that pin 3 of the Sensor is heater (+) and must be power by a fused/switched 12V supply.
C2-50	Battery Perm Power	Dedicated power management CPU	Full time battery power. MUST be powered before the ignition switch input is triggered (See C1-65).
C2-51	Coil 7	25 mA max source current	0-5V Falling edge fire. DO NOT connect directly to coil primary. Must use an ignitor OR CDI that accepts a FALLING edge fire signal.
C2-52	Coil 8	25 mA max source current	0-5V Falling edge fire. DO NOT connect directly to coil primary. Must use an ignitor OR CDI that accepts a FALLING edge fire signal.
C2-53	Coil 9	25 mA max source current	0-5V Falling edge fire. DO NOT connect directly to coil primary. Must use an ignitor OR CDI that accepts a FALLING edge fire signal.

Infinity Pin	Hrdwr Ref.	Hardware Specification	Notes
C2-54	Coil 10	25 mA max source current	0-5V Falling edge fire. DO NOT connect directly to coil primary. Must use an ignitor OR CDI that accepts a FALLING edge fire signal.
C2-55	Highside 2	Highside switch, 0.7A max, Solid State Relay, NO internal flyback diode.	See Setup Wizard Page "Output Function Assignment" for setup options.
C2-56	Not used	Not used	Not used

Universal Pinout, Infinity-6/8h

Infinity Pin	Hardware Ref.	Hardware Specification	Notes
C1-1	Lowside 4	Lowside switch, 1.7A max, NO internal flyback diode. 12V pullup	See Setup Wizard Page "Output Function Assignment" for setup options.
C1-2	Lowside 5	Lowside switch, 6A max with internal flyback diode. Inductive load should NOT have full time power. 12V pullup	See Setup Wizard Page "Output Function Assignment" for setup options.
C1-3*	Lowside 6 (*Infinity-6 Only)	Lowside switch, 6A max with internal flyback diode. Inductive load should NOT have full time power. No pullup	See Setup Wizard Page "Output Function Assignment" for setup options.
C1-3**	Injector 7 (**Infinity-8H Only)	For use with high impedance (10-15 ohms) injectors only, 1.7A max.	Available on P/N 30-7108 only
C1-4*	Lowside 7 (*Infinity-6 Only)	Lowside switch, 6A max, NO internal flyback diode. No pullup	See Setup Wizard Page "Output Function Assignment" for setup options.
C1-4**	Injector 8 (**Infinity-8H Only)	For use with high impedance (10-15 ohms) injectors only, 1.7A max.	Available on P/N 30-7108 only
C1-5	UEGO 1 Heat	Bosch UEGO controller	Lowside switch for UEGO heater control. Connect to pin 4 of Bosch UEGO sensor. NOTE that pin 3 of the Sensor is heater (+) and must be power by a fused/switched 12V supply.
C1-6	UEGO 1 IA		Trim Current signal. Connect to pin 2 of Bosch UEGO sensor
C1-7	UEGO 1 IP		Pumping Current signal. Connect to pin 6 of Bosch UEGO sensor
C1-8	UEGO 1 UN		Nernst Voltage signal. Connect to pin 1 of Bosch UEGO sensor
C1-9	UEGO 1 VM		Virtual Ground signal. Connect to pin 5 of Bosch UEGO sensor.
C1-10	Battery Perm Power	Dedicated power management CPU	Full time battery power. MUST be powered before the ignition switch input is triggered (See C1-48).

Infinity Pin	Hardware Ref.	Hardware Specification	Notes
C1-11	Coil 4	25 mA max source current	0-5V Falling edge fire. DO NOT connect directly to coil primary. Must use an ignitor OR CDI that accepts a FALLING edge fire signal.
C1-12	Coil 3	25 mA max source current	0-5V Falling edge fire. DO NOT connect directly to coil primary. Must use an ignitor OR CDI that accepts a FALLING edge fire signal.
C1-13	Coil 2	25 mA max source current	0-5V Falling edge fire. DO NOT connect directly to coil primary. Must use an ignitor OR CDI that accepts a FALLING edge fire signal.
C1-14	Coil 1	25 mA max source current	0-5V Falling edge fire. DO NOT connect directly to coil primary. Must use an ignitor OR CDI that accepts a FALLING edge fire signal.
C1-15	Coil 6	25 mA max source current	0-5V Falling edge fire. DO NOT connect directly to coil primary. Must use an ignitor OR CDI that accepts a FALLING edge fire signal.
C1-16	Coil 5	25 mA max source current	0-5V Falling edge fire. DO NOT connect directly to coil primary. Must use an ignitor OR CDI that accepts a FALLING edge fire signal.
C1-17	Crankshaft Position Sensor VR+	Differential Variable Reluctance Zero Cross Detection	See Setup Wizard page Cam/Crank for options.
C1-18	Crankshaft Position Sensor VR-		See Setup Wizard page Cam/Crank for options.
C1-19	Camshaft Position Sensor 1 VR-	Differential Variable Reluctance Zero Cross Detection	See Setup Wizard page Cam/Crank for options.
C1-20	Camshaft Position Sensor 1 VR+		See Setup Wizard page Cam/Crank for options.
C1-21	Lowside 2	Lowside switch, 1.7A max, NO internal flyback diode. No pullup	See Setup Wizard Page "Output Function Assignment" for setup options.
C1-22	Lowside 3	Lowside switch, 6A max with internal flyback diode. Inductive load should NOT have full time power.	See Setup Wizard Page "Output Function Assignment" for setup options.

Infinity Pin	Hardware Ref.	Hardware Specification	Notes
		No pullup	
C1-23	Analog Sensor Ground	Dedicated analog ground	Analog 0-5V sensor ground
C1-24	Analog Sensor Ground	Dedicated analog ground	Analog 0-5V sensor ground
C1-25	Crankshaft Position Sensor Hall	10K pullup to 12V. Will work with ground or floating switches.	See Setup Wizard page Cam/Crank for options.
C1-26	Camshaft Position Sensor 1 Hall	10K pullup to 12V. Will work with ground or floating switches.	See Setup Wizard page Cam/Crank for options.
C1-27	Digital 2	10K pullup to 12V. Will work with ground or floating switches.	See Setup Wizard page Cam/Crank for options.
C1-28	Dig3 [Hz] / Dig3 Duty	10K pullup to 12V. Will work with ground or floating switches.	See Setup Wizard page "Input Function Assignments" for setup options.
C1-29	Dig4 [Hz] / Dig4 Duty	10K pullup to 12V. Will work with ground or floating switches.	See Setup Wizard page "Input Function Assignments" for setup options.
C1-29	RS232 Rx	RS232 Line Driver/Receiver	Future expansion
C1-30	Digital 5	10K pullup to 12V. Will work with ground or floating switches.	See Setup Wizard page "Input Function Assignments" for setup options.
C1-30	RS232 Tx	RS232 Line Driver/Receiver	Future expansion
C1-31*	Dig6 [Hz] / Dig6_Duty (*Infinity-6 Only)	10K pullup to 12V. Will work with ground or floating switches.	See Setup Wizard page "Input Function Assignments" for setup options.
C1-31**	Coil 7 (**Infinity-8H Only)	25 mA max source current	Available on P/N 30-7108 only. 0-5V Falling edge fire. DO NOT connect directly to coil primary. Must use an ignitor OR CDI that accepts a FALLING edge fire signal.
C1-32*	Digital 7 (*Infinity-6 Only)	10K pullup to 12V. Will work with ground or floating switches.	See Setup Wizard page "Input Function Assignments" for setup options.
C1-32**	Coil 8 (**Infinity-8H Only)	25 mA max source current	Available on P/N 30-7108 only. 0-5V Falling edge fire. DO NOT connect directly to coil primary. Must use an ignitor OR CDI that accepts a FALLING edge fire signal.
C1-33	Battery Ground	Battery Ground	Connect directly to battery ground

Infinity Pin	Hardware Ref.	Hardware Specification	Notes
C1-34	CANL A	Dedicated High Speed CAN Transceiver	Recommend twisted pair (one twist per 2") with terminating resistor. Contact AEM for additional information.
C1-35	CANH A	Dedicated High Speed CAN Transceiver	Recommend twisted pair (one twist per 2") with terminating resistor. Contact AEM for additional information.
C1-36	CanL B	Dedicated High Speed CAN Transceiver	Not used, reserved for future expansion.
C1-37	CanH B	Dedicated High Speed CAN Transceiver	Not used, reserved for future expansion.
C1-38	Analog Temp 1	12 bit A/D, 2.49K pullup to 5V	Default Coolant Temperature Input
C1-39	Analog Temp 2	12 bit A/D, 2.49K pullup to 5V	Default Air Temperature Input
C1-40	Analog Temp 3	12 bit A/D, 2.49K pullup to 5V	Default Oil Temperature Input. See Setup Wizard page "Input Function Assignments" for setup options.
C1-41	Lowside 0	Lowside switch, 1.7A max, NO internal flyback diode. No pullup	See Setup Wizard Page "Output Function Assignment" for setup options.
C1-42	Lowside 1	Lowside switch, 6A max with internal flyback diode. Inductive load should NOT have full time power. No pullup	See Setup Wizard Page "Output Function Assignment" for setup options.
C1-43	Battery Ground	Battery Ground	Connect directly to battery ground
C1-44	Knock Sensor 1	Dedicated knock signal processor	See Setup Wizard page Knock Setup for options.
C1-45	Knock Sensor 2	Dedicated knock signal processor	See Setup Wizard page Knock Setup for options.
C1-46	Battery Ground	Battery Ground	Connect directly to battery ground
C1-47	EFI Main Relay Switched Ground Output	0.7A max ground sink for external relay control	Will activate at key on and at key off according to the configuration settings.
C1-48	Ignition Switch	10K pulldown	Full time battery power must be available at C1-10 before this input is

Infinity Pin	Hardware Ref.	Hardware Specification	Notes
			triggered.
C1-49	+5V Sensor Power	Regulated, fused +5V supply for sensor power	Analog sensor power
C1-50	+5V Sensor Power	Regulated, fused +5V supply for sensor power	Analog sensor power
C1-51	Analog 7	12 bit A/D, 100K pullup to 5V	Default primary Throttle Position sensor input. 0-5V analog signal. Use +5V Out pins as power supply and Sensor Ground pins as the low reference. Do not connect signals referenced to +12V as this can permanently damage the ECU. See Setup Wizard Set Throttle Range page for automatic min/max calibration. Monitor the Throttle [%] channel. Also DB1_TPSA [%] for DBW applications.
C1-52	Analog 8	12 bit A/D, 100K pullup to 5V	Default Manifold Pressure Sensor input. 0-5V analog signal. Use +5V Out pins as power supply and Sensor Ground pins as the low reference. Do not connect signals referenced to +12V as this can permanently damage the ECU.
C1-53	Analog 9	12 bit A/D, 100K pullup to 5V	Default Fuel Pressure Sensor Input. 0-5V analog signal. Use +5V Out pins as power supply and Sensor Ground pins as the low reference. Do not connect signals referenced to +12V as this can permanently damage the ECU.
C1-54	VR+ 2	Differential Variable Reluctance Zero Cross Detection	See Setup Wizard page "Input Function Assignments" for setup options.
C1-55	VR- 2		
C1-56	VR- 3	Differential Variable Reluctance Zero Cross Detection	See Setup Wizard page "Input Function Assignments" for setup options.
C1-57	VR+ 3		

Infinity Pin	Hardware Ref.	Hardware Specification	Notes
C1-58	Highside 0	2.6A max, High Side Solid State Relay	See Setup Wizard Page "Output Function Assignment" for setup options.
C1-59	Stepper 1B	Automotive, Programmable Stepper Driver, up to 28V and $\pm 1.4A$	Be sure that each internal coil of the stepper motor are properly paired with the 1A/1B and 2A/2B ECU outputs. Supports Bi-Polar stepper motors only.
C1-60	Stepper 2B	Automotive, Programmable Stepper Driver, up to 28V and $\pm 1.4A$	Be sure that each internal coil of the stepper motor are properly paired with the 1A/1B and 2A/2B ECU outputs. Supports Bi-Polar stepper motors only.
C1-61	DBW1 Motor -	5.0A max Throttle Control Hbridge Drive	+12V to close
C1-62	DBW1 Motor +	5.0A max Throttle Control Hbridge Drive	+12V to open
C1-63	Main Relay Power Input	12 volt power from relay	12 volt power from relay. Relay must be controlled by +12V Relay Control signal, pin C1-47 above.
C1-64	Injector 6	Saturated (P/N 30-7108) or peak and hold, 3A max continuous (P/N 30-7106)	Injector 6
C1-65	Injector 5	Saturated (P/N 30-7108) or peak and hold, 3A max continuous (P/N 30-7106)	Injector 5
C1-66	Injector 4	Saturated (P/N 30-7108) or peak and hold, 3A max continuous (P/N 30-7106)	Injector 4
C1-67	Battery Ground	Battery Ground	Connect directly to battery ground
C1-68	Main Relay Power Input	12 volt power from relay	12 volt power from relay. Relay must be controlled by +12V Relay Control signal, pin C1-47 above.
C1-69	Analog 19	12 bit A/D, 100K pullup to 5V	0-5V analog signal. Use +5V Out pins as power supply and Sensor Ground pins as the low reference. Do not connect signals referenced to +12V as this can permanently damage the ECU. See Setup Wizard page "Input Function Assignments" for setup

Infinity Pin	Hardware Ref.	Hardware Specification	Notes
			options.
C1-70	Analog 18	12 bit A/D, 100K pullup to 5V	0-5V analog signal. Use +5V Out pins as power supply and Sensor Ground pins as the low reference. Do not connect signals referenced to +12V as this can permanently damage the ECU. See Setup Wizard page "Input Function Assignments" for setup options.
C1-71	Analog 16	12 bit A/D, 100K pullup to 5V	0-5V analog signal. Use +5V Out pins as power supply and Sensor Ground pins as the low reference. Do not connect signals referenced to +12V as this can permanently damage the ECU. See Setup Wizard page "Input Function Assignments" for setup options.
C1-72	Flash Enable	10K pulldown	Not usually needed for automatic firmware updates through Infinity Tuner. If connection errors occur during update, connect 12 volts to this pin before proceeding with upgrade. Disconnect the 12 volts signal after the update.
C1-73	Analog 13	12 bit A/D, 100K pullup to 5V	Default Oil Pressure Sensor input. 0-5V analog signal. Use +5V Out pins as power supply and Sensor Ground pins as the low reference. Do not connect signals referenced to +12V as this can permanently damage the ECU.
C1-74	Analog 11	12 bit A/D, 100K pullup to 5V	0-5V analog signal. Use +5V Out pins as power supply and Sensor Ground pins as the low reference. Do not connect signals referenced to +12V as this can permanently damage the ECU. See Setup Wizard page "Input Function Assignments" for setup options.
C1-75	Analog 10	12 bit A/D, 100K pullup to 5V	0-5V analog signal. Use +5V Out pins as power supply and Sensor Ground pins as the low reference. Do not connect signals referenced to +12V as this can permanently damage the ECU. See Setup Wizard page "Input Function Assignments" for setup

Infinity Pin	Hardware Ref.	Hardware Specification	Notes
			options.
C1-76	Injector 3	Saturated (P/N 30-7108) or peak and hold, 3A max continuous (P/N 30-7106)	Injector 3
C1-77	Injector 2	Saturated (P/N 30-7108) or peak and hold, 3A max continuous (P/N 30-7106)	Injector 2
C1-78	Injector 1	Saturated (P/N 30-7108) or peak and hold, 3A max continuous (P/N 30-7106)	Injector 1
C1-79	Stepper 2A	Automotive, Programmable Stepper Driver, up to 28V and $\pm 1.4A$	Be sure that each internal coil of the stepper motor are properly paired with the 1A/1B and 2A/2B ECU outputs. Supports Bi-Polar stepper motors only.
C1-80	Stepper 1A	Automotive, Programmable Stepper Driver, up to 28V and $\pm 1.4A$	Be sure that each internal coil of the stepper motor are properly paired with the 1A/1B and 2A/2B ECU outputs. Supports Bi-Polar stepper motors only.

Connector Views Infinity-8/10/12

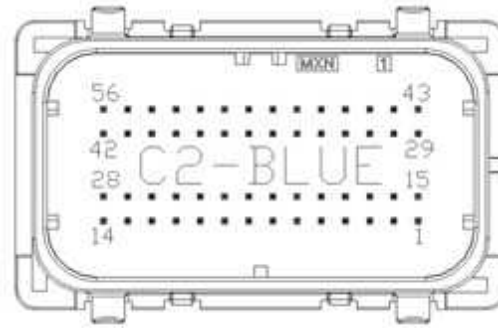
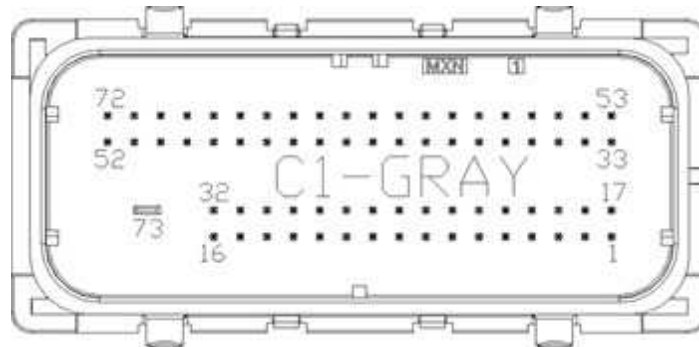

Connector Views Infinity-6/8h

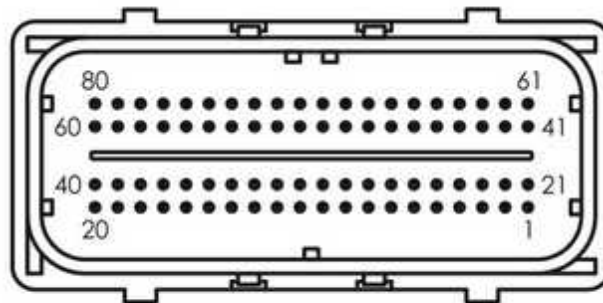

INFINITY "C1" 80 PIN

Example System Schematics

Custom wiring harness projects should only be undertaken by experienced harness builders. If in doubt, please contact AEM for recommendations.

For users wishing to build their own wiring harnesses from scratch, the following kits are available to help.

30-3701 Infinity-8/10/12 Plug & Pin Kit

Bare necessities to begin a custom wire harness design. Includes 73- and 56-pin Molex MX123 harness connectors, terminals and sealing plugs, main relay and relay socket.

30-3702 Infinity-8/10/12 Mini-harness

This harness is intended to be used as a starting point by experienced harness builders. It saves time by including basic power distribution features that can be expanded to suit many application requirements. It allows the harness builder to populate the ECU connector with only the features needed by the application. Includes 100 96" pre-terminated leads.

30-3703 Infinity-8/10/12 Mini-harness

This harness is intended to be used as a starting point by experienced harness builders. It saves time by including basic power distribution features that can be expanded to suit many application requirements. It allows the harness builder to populate the ECU connector with only the features needed by the application.

30-3704 Infinity-6/8h Plug & Pin Kit

Bare necessities to begin a custom wire harness design. Includes 80-pin Molex MX123 harness connector, terminals and sealing plugs, main relay and relay socket.

30-3805 Universal modular V8 harness system for Infinity-8/10 systems

The Infinity Universal Modular V8 Harness system consists of a universal core harness and optional application specific extensions. It was designed with flexibility in mind. The harness system includes many features and it can be used in many different applications.

30-3809 Universal modular V8 harness system for Infinity-6/8h systems

The Infinity Universal Modular V8 Harness system consists of a universal core harness and optional application specific extensions. It was designed with flexibility in mind. The harness system includes many features and it can be used in many different applications.

30-3705 Universal Mini Harness for Infinity-6/8h systems

This harness is intended to be used as a starting point by experienced harness builders. It saves time by including basic power distribution features that can be expanded to suit many application requirements. It allows the harness builder to populate the ECU connector with only the features needed by the application.

30-3706 Universal Mini Flying Lead for Infinity-6/8h systems

This harness is intended to be used as a starting point by experienced harness builders. It saves time by including basic power distribution features that can be expanded to suit many application requirements.

The following schematics show examples for wiring a basic Infinity system. Examples are included for both Infinity-6/8h and Infinity-8/10/12 hardware platforms. ***The power, ground and accessory relay sections of the following schematics must be strictly followed to avoid inconsistent power sequencing and possible ECU damage.***

Power Distribution, Infinity-6/8h

NAME	FUNCTION
GND	Battery ground
PERM	Fused connection to battery positive terminal (+12V, always hot)
IGN SW	Fused connection to vehicle ignition switch (+12V in RUN/CRANK only)
RELAY	Switched ground from ECU connected to relay coil primary negative
+12V	Relay driven +12V power source for ECU power and auxiliary outputs
+5V Reference	+5V supplied by ECU
Sensor Ground	Analog ground used as ground point for sensors

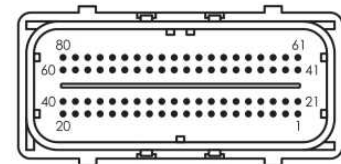

INFINITY "C1" 80 PIN

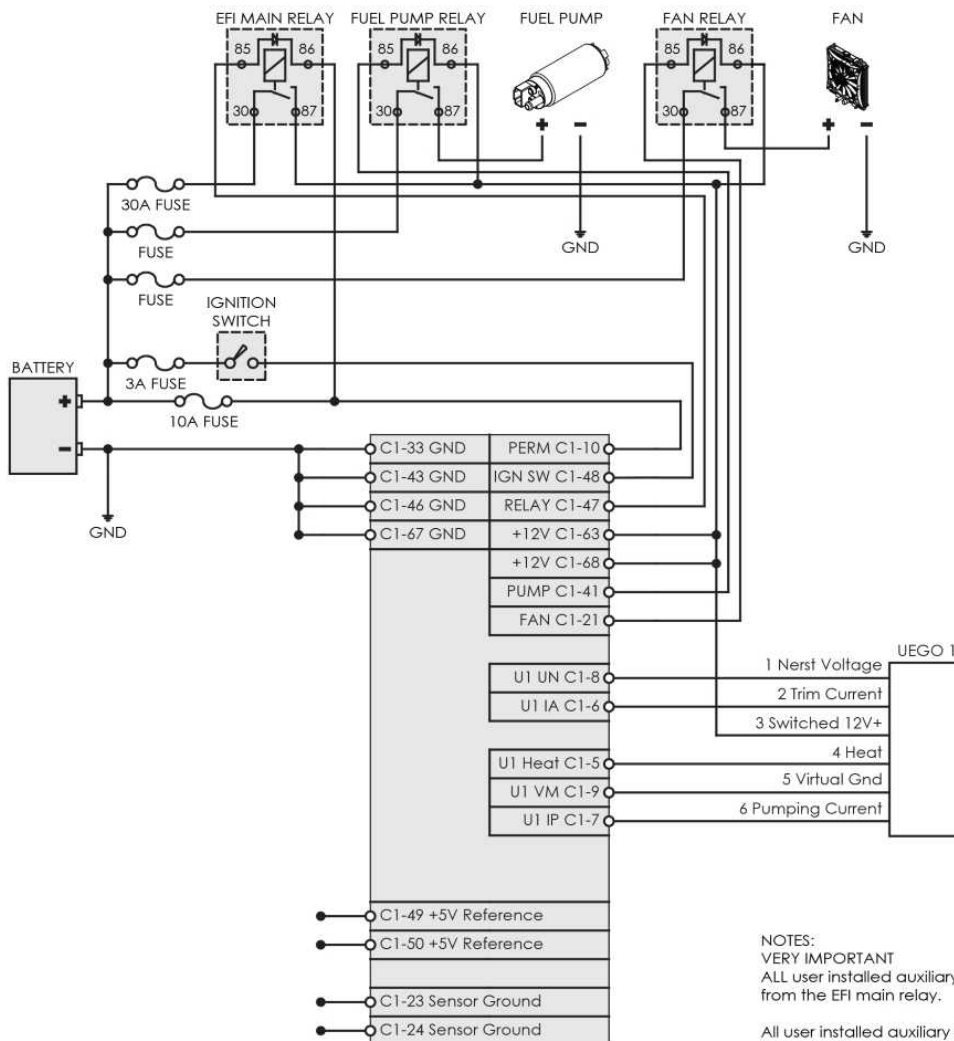

NOTES:
 VERY IMPORTANT
 ALL user installed auxiliary relays must be powered by the output from the EFI main relay.

All user installed auxiliary circuits should be protected with a properly sized fuse as shown.

Relays with internal diodes must have the anode side of the coil connected to the ECU.



Drawing: Power Distribution

ECU: Infinity-6/8h

Date: 12/14/2014

Rev: B

Engineer: Nakano

Power Distribution, Infinity-8/10/12

NAME	FUNCTION
GND	Battery ground
PERM	Fused connection to battery positive terminal (+12V, always hot)
IGN SW	Fused connection to vehicle ignition switch (+12V in RUN/CRANK only)
RELAY	Switched ground from ECU connected to relay coil primary negative
+12V	Relay driven +12V power source for ECU power and auxiliary outputs
+5V Ref	+5V supplied by ECU
SGND	Analog ground used as ground point for sensors

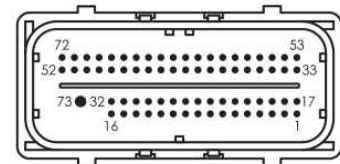

INFINITY "C1" 73 PIN

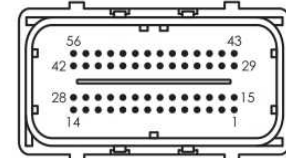

INFINITY "C2" 56 PIN

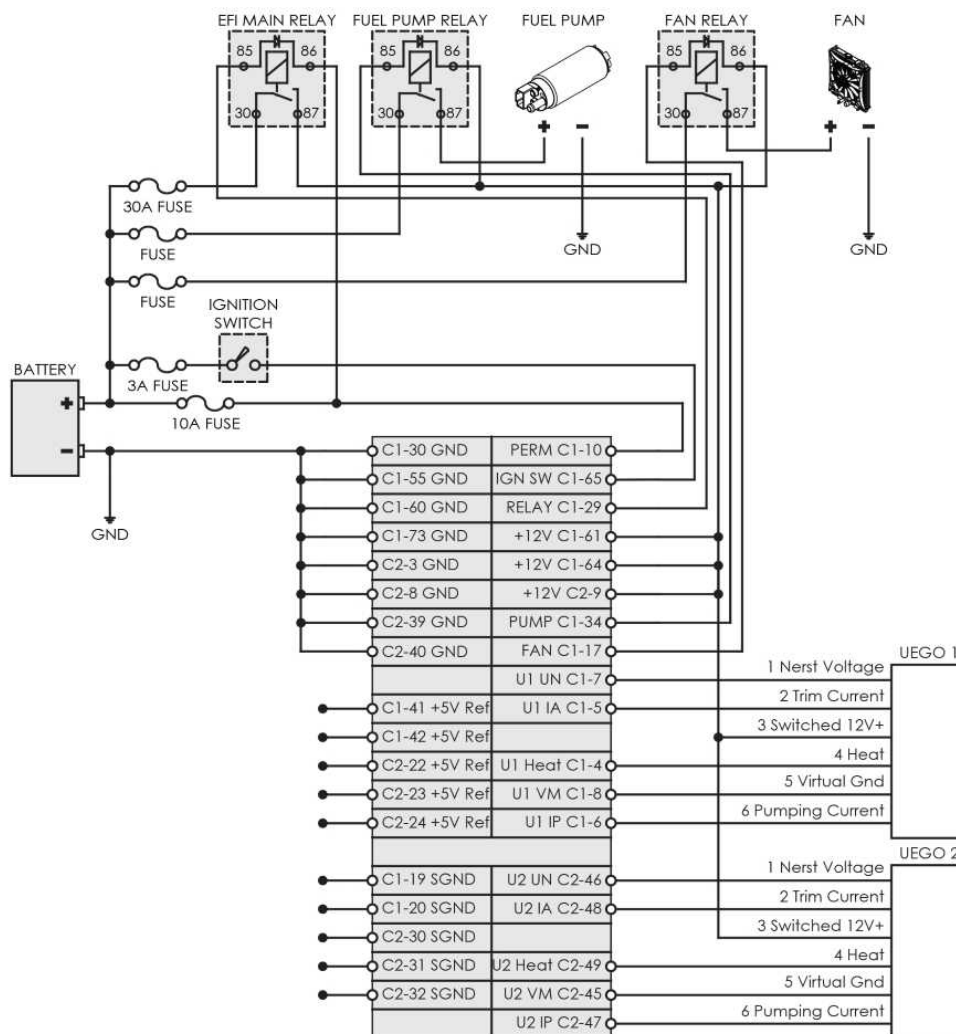

NOTES:
 VERY IMPORTANT
 ALL user installed auxiliary relays must be powered by the output from the EFI main relay.
 All user installed auxiliary circuits should be protected with a properly sized fuse as shown.
 Relays with internal diodes must have the anode side of the coil connected to the ECU.



Drawing: Power Distribution

ECU: Infinity-8/10/12

Date: 12/14/2015

Rev: B

Engineer: Nakano

Internal UEGO, Infinity-6/8h

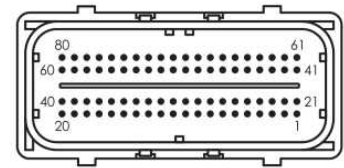

INFINITY "C1" 80 PIN

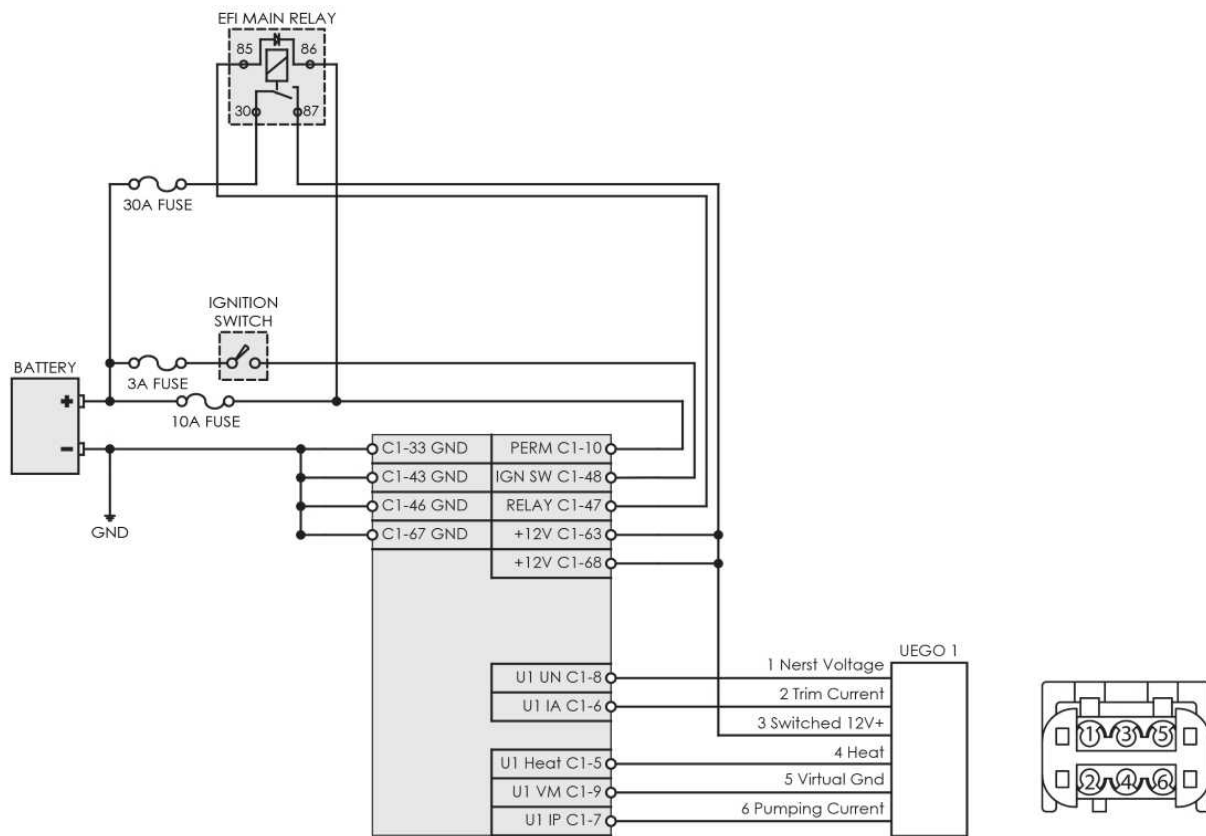

NOTES:
 VERY IMPORTANT
 ALL user installed auxiliary relays must be powered by the output from the EFI main relay.

All user installed auxiliary circuits should be protected with a properly sized fuse as shown.

Relays with internal diodes must have the anode side of the coil connected to the ECU.



Drawing: Internal Wideband UEGO Sensor

ECU: Infinity-6/8h

Date: 12/14/2014

Rev: A

Engineer: Nakano

Internal UEGO, Infinity-8/10/12

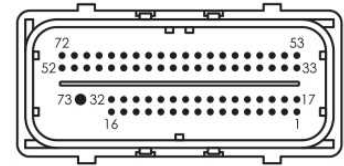
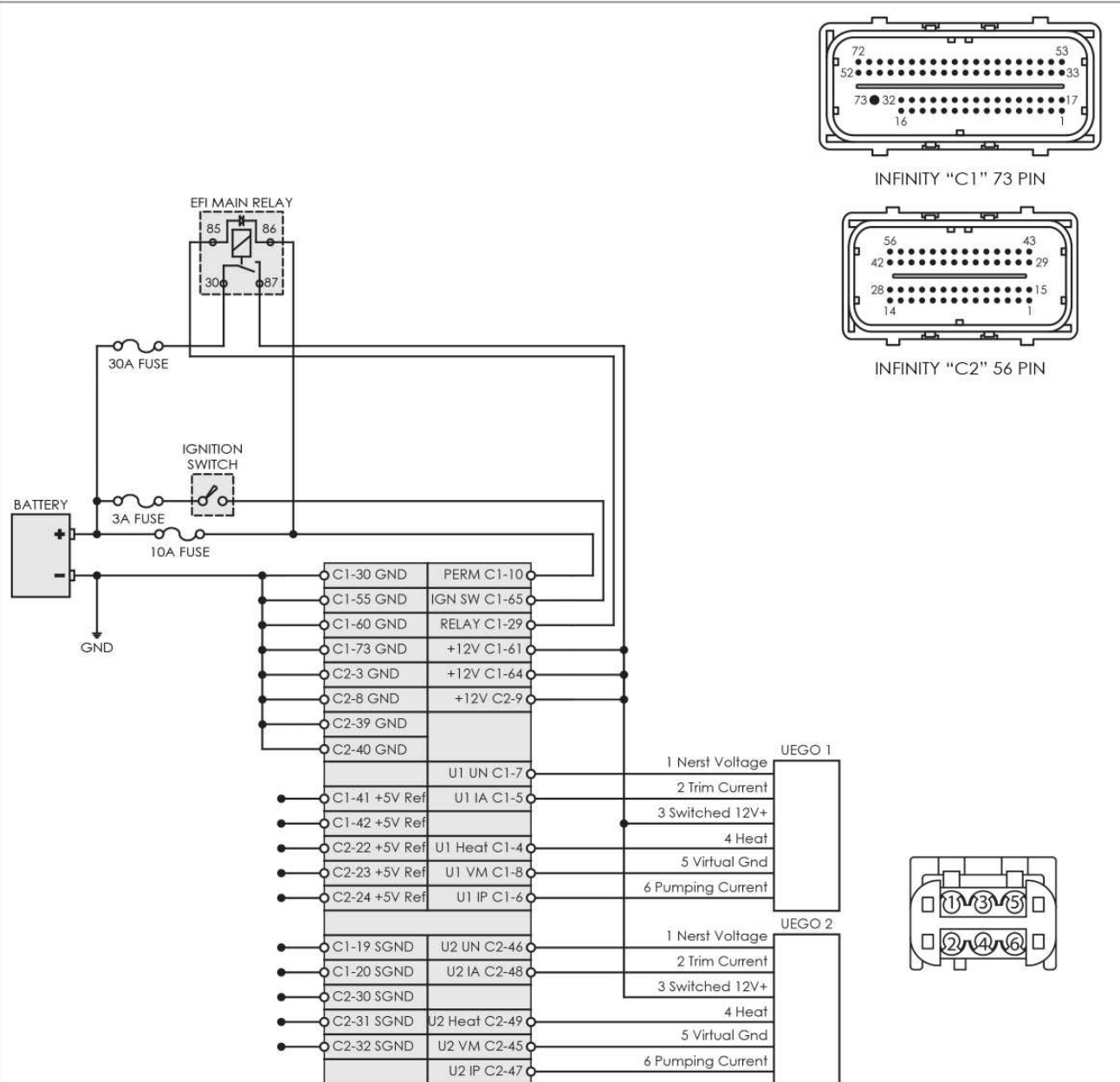

INFINITY "C1" 73 PIN

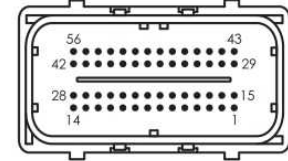

INFINITY "C2" 56 PIN

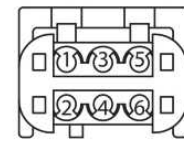

NOTES:
 VERY IMPORTANT
 ALL user installed auxiliary relays must be powered by the output from the EFI main relay.

All user installed auxiliary circuits should be protected with a properly sized fuse as shown.

Relays with internal diodes must have the anode side of the coil connected to the ECU.



Drawing: Internal Wideband UEGO Sensors

ECU: Infinity-8/10/12

Date: 12/14/2015

Rev: A

Engineer: Nakano

95 BMW E36 M3, Infinity-6/8h

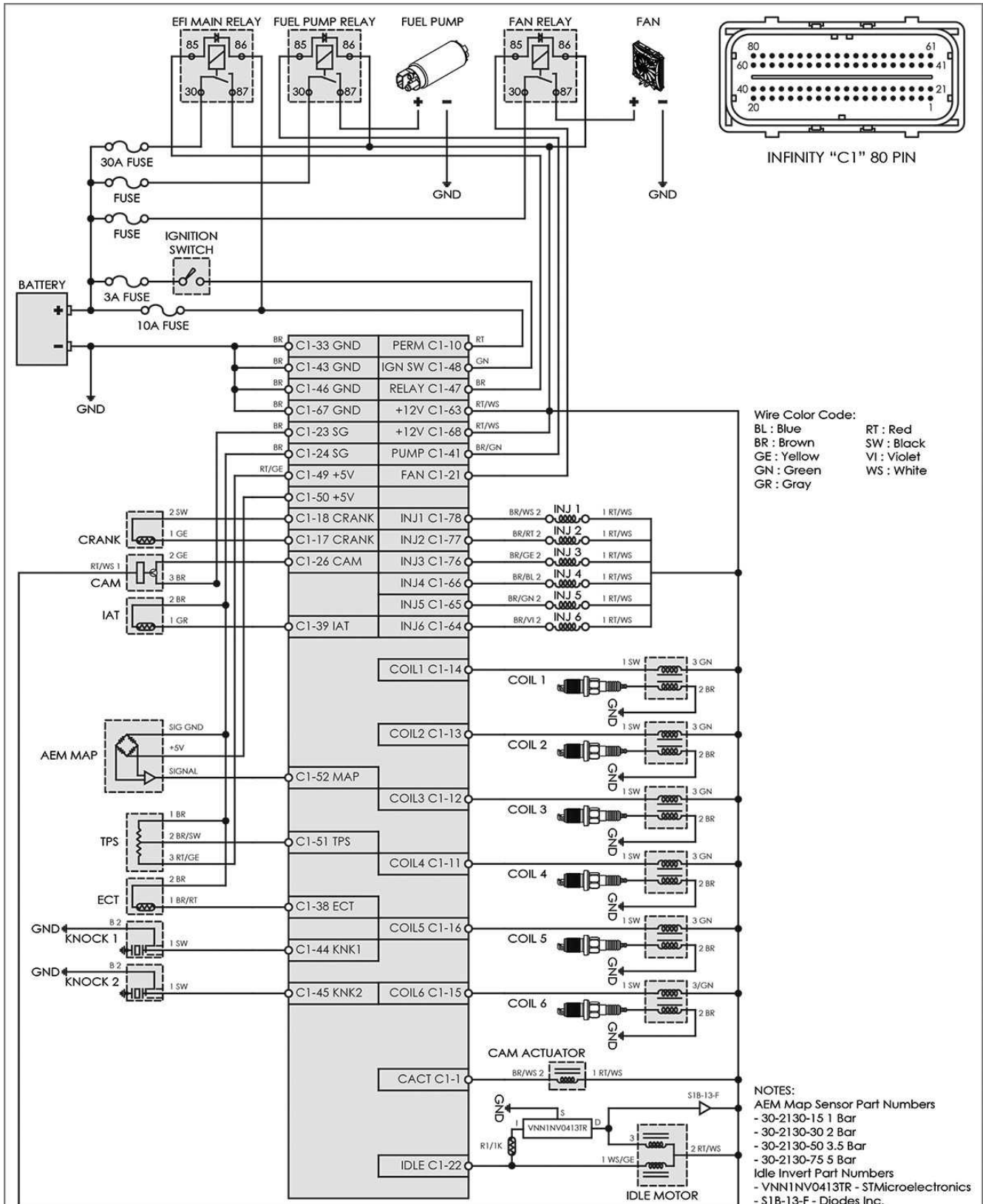

Drawing: 1995 BMW M3 E36 M50

ECU: Infinity-6/8h

Date: 02/20/2014

Rev: A

Engineer: Nakano

95 BMW E36 M3, Infinity-8/10/12

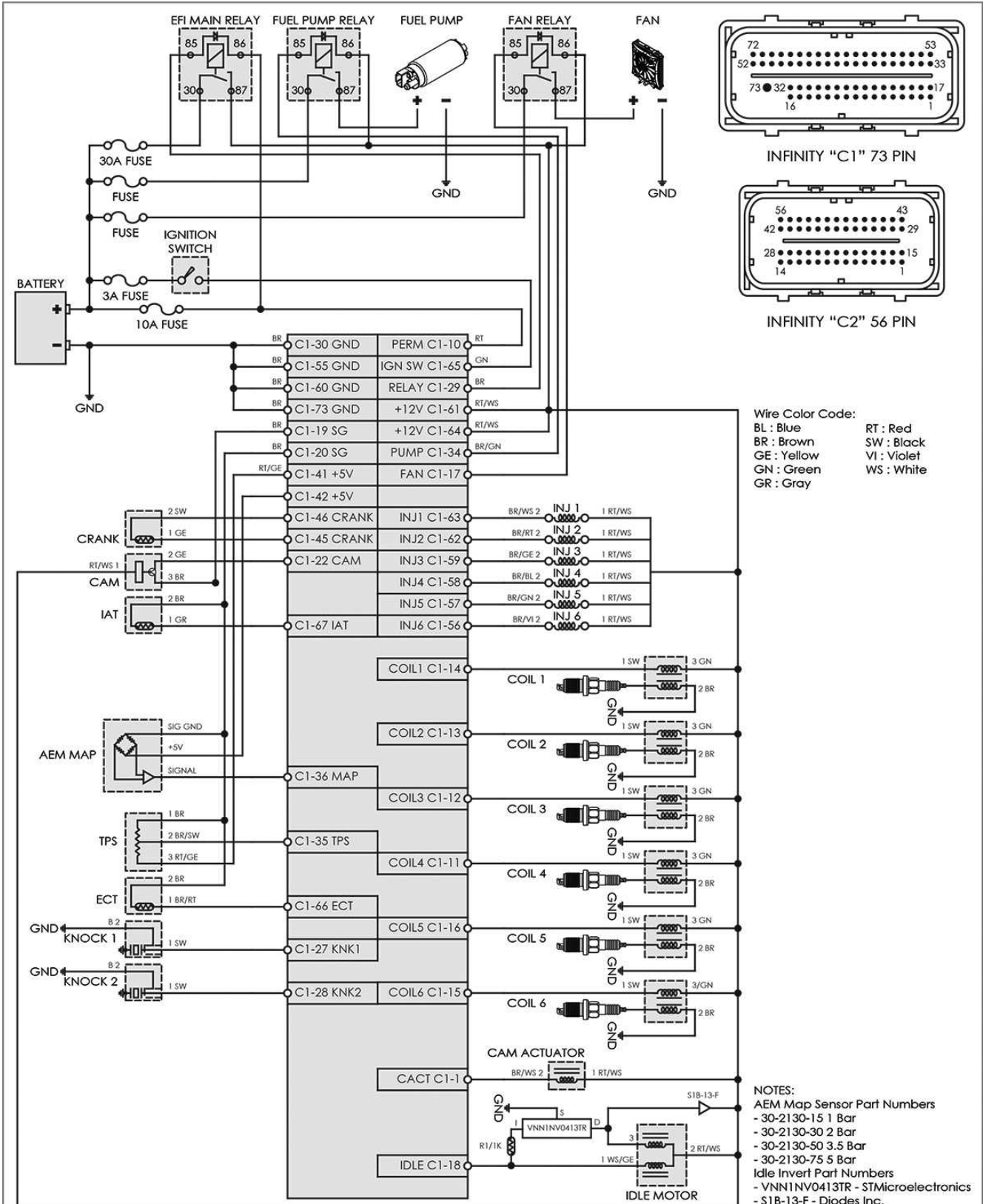

Drawing: 1995 BMW M3 E36 M50

ECU: Infinity-8/10/12

Date: 02/20/2014

Rev: A

Engineer: Nakano

EVO VIII, Infinity-6/8h

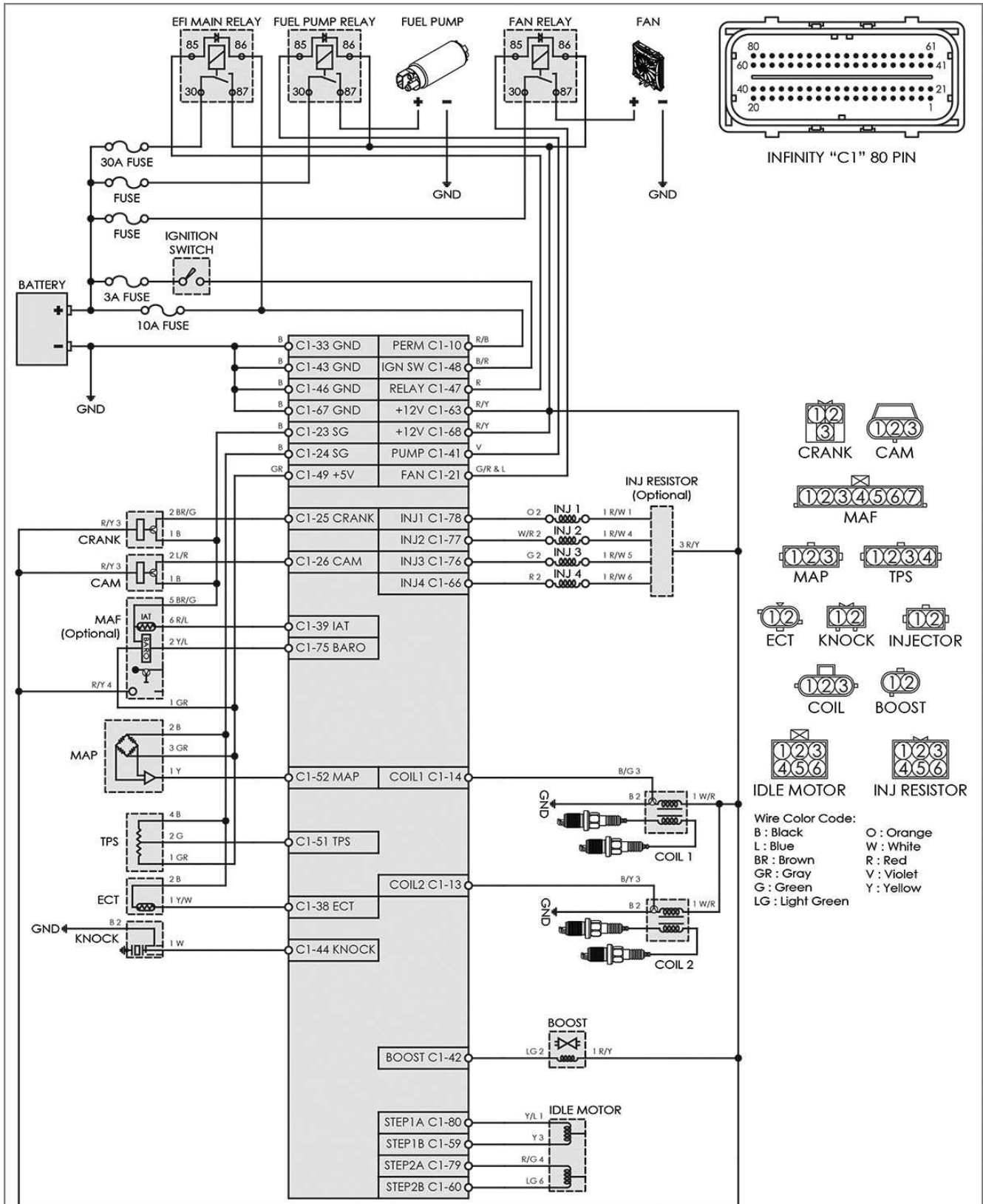

Drawing: 2003-05 Mitsubishi EVO VIII

ECU: Infinity-6/8h

Date: 02/19/2014

Rev: A

Engineer: Nakano

EVO VIII, Infinity-8/10/12

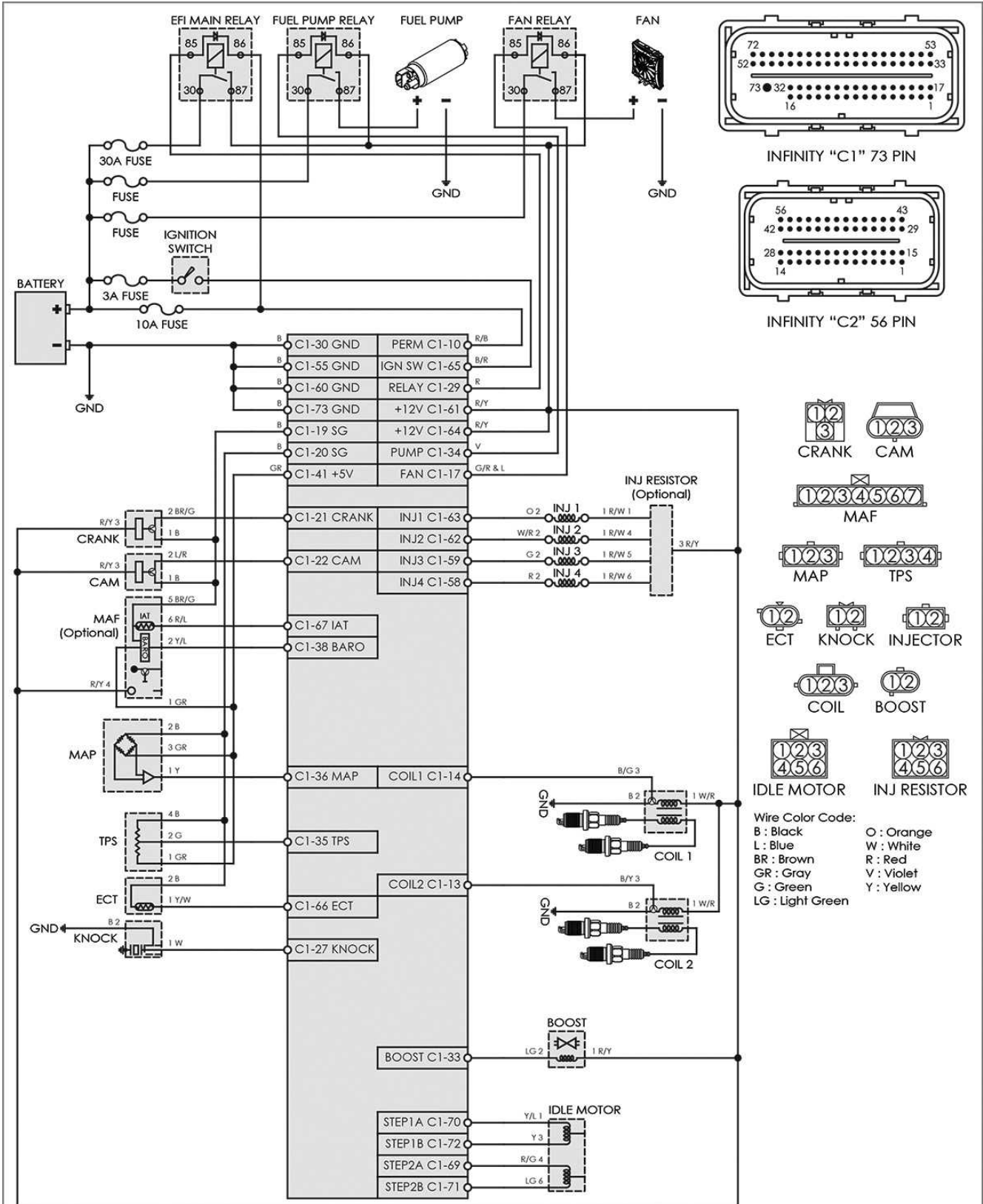

Drawing: 2003-05 Mitsubishi EVO VIII

ECU: Infinity-8/10/12

Date: 02/19/2014

Rev: A

Engineer: Nakano

EVO IX Pinout, Infinity-6/8h

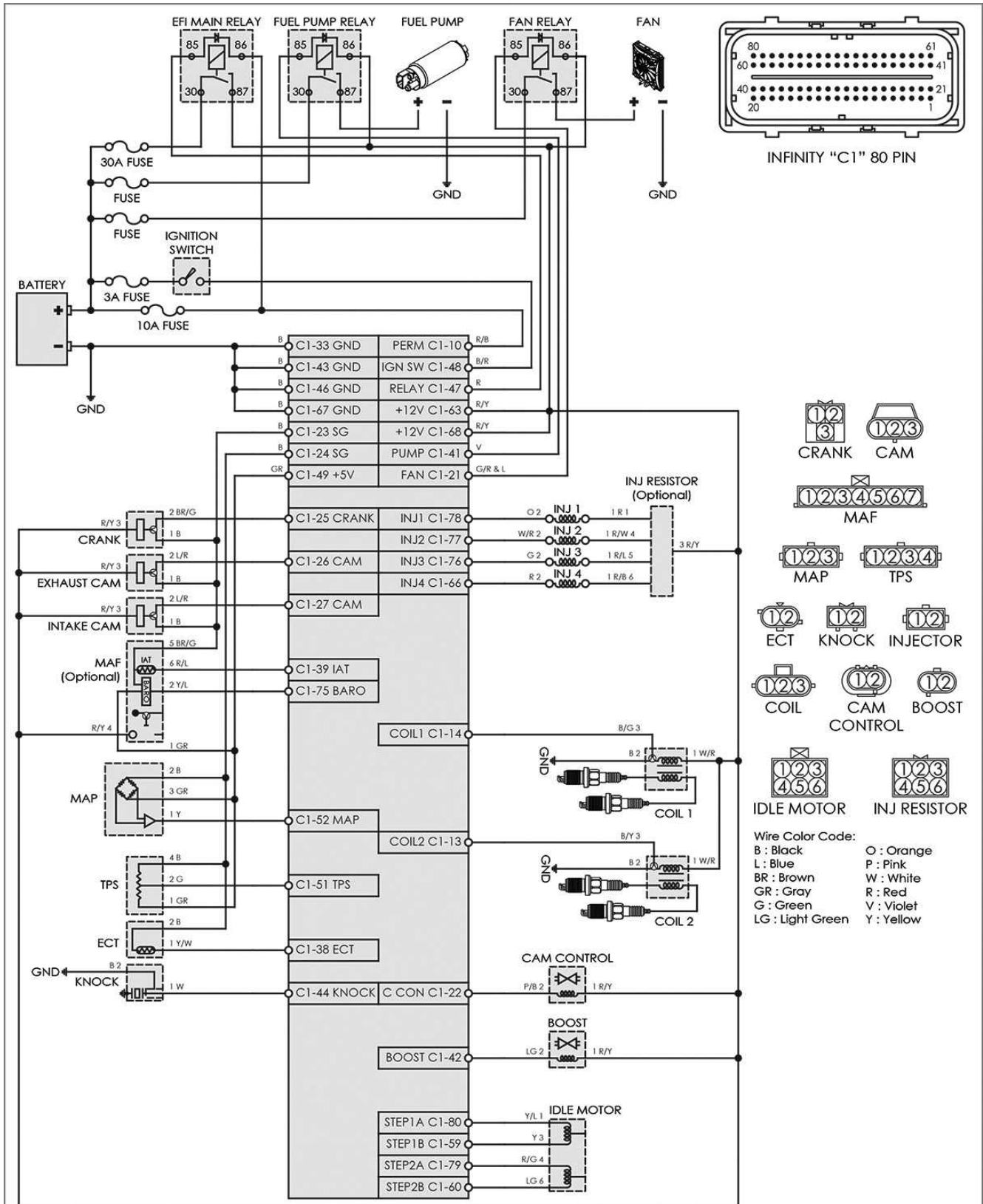

Drawing: 2006 Mitsubishi EVO IX

ECU: Infinity-6/8h

Date: 02/20/2014

Rev: A

Engineer: Nakano

EVO IX Pinout, Infinity-8/10/12

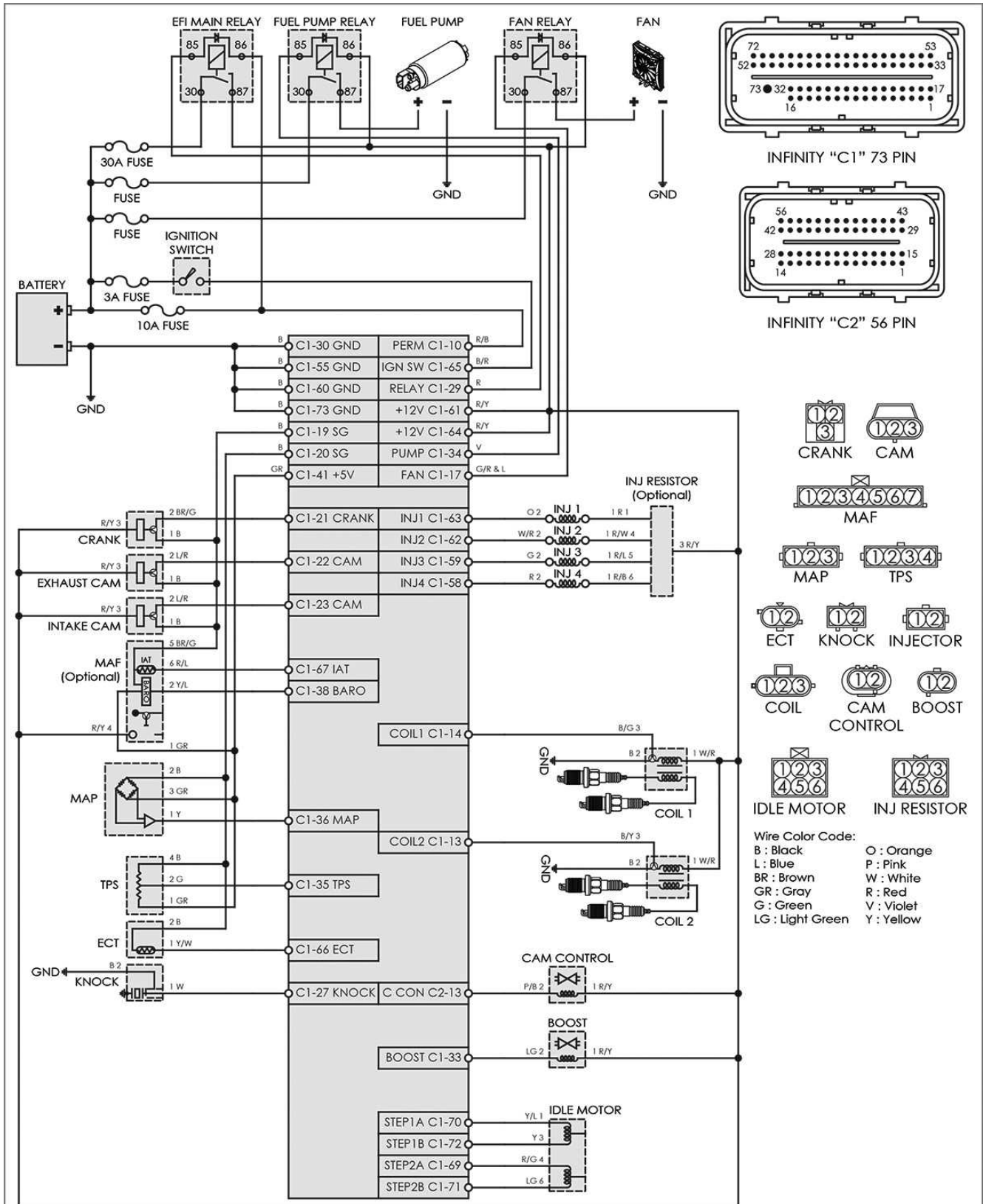

Drawing: 2006 Mitsubishi EVO IX

ECU: Infinity-8/10/12

Date: 02/20/2014

Rev: A

Engineer: Nakano

93-98 Toyota Supra 2JZGTE, Infinity-6/8h

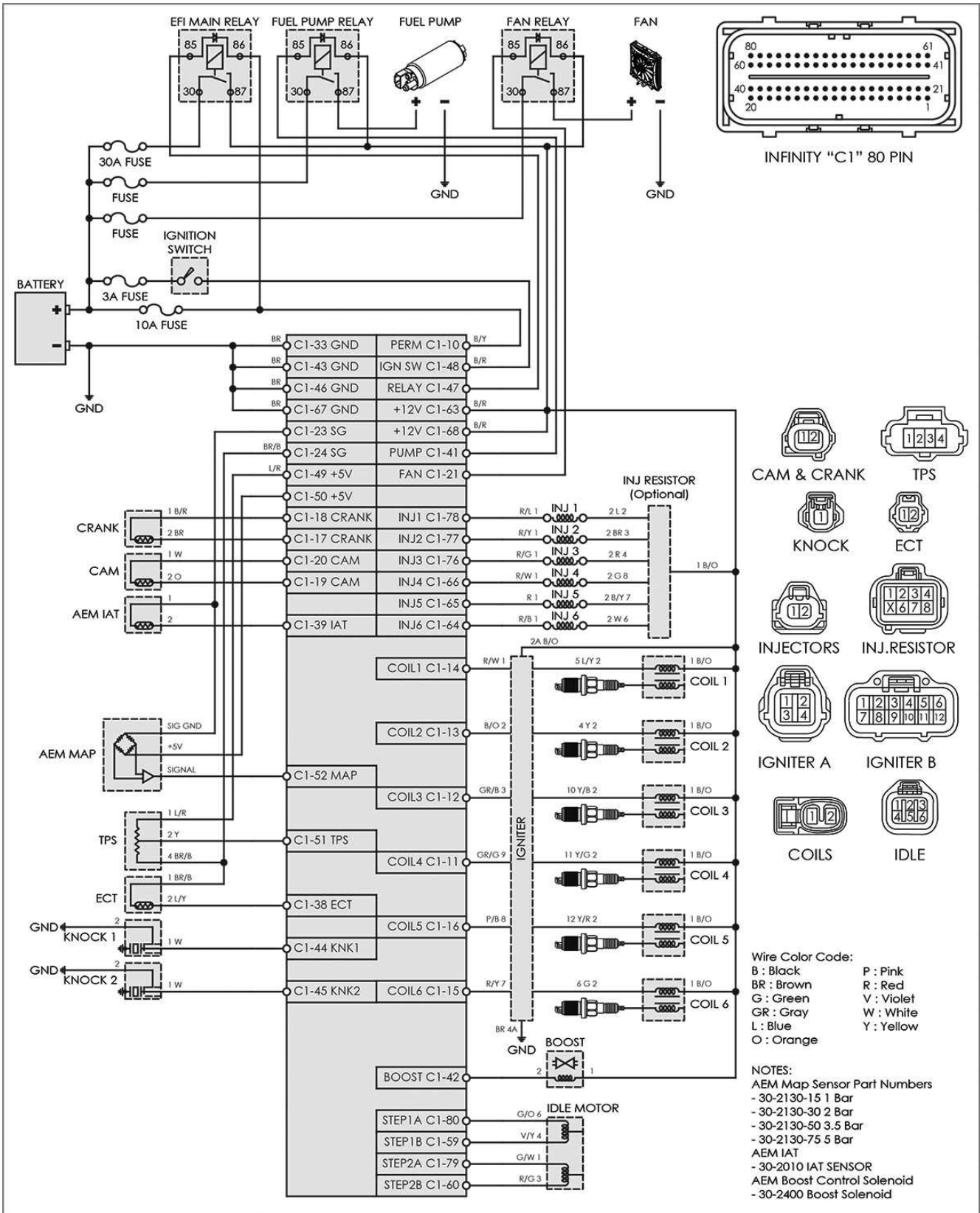

Drawing: 1993-98 Toyota Supra 2JZGTE

ECU: Infinity-6/8h

Date: 02/24/2014

Rev: A

Engineer: Nakano

93-98 Toyota Supra 2JZGTE, Infinity-8/10/12

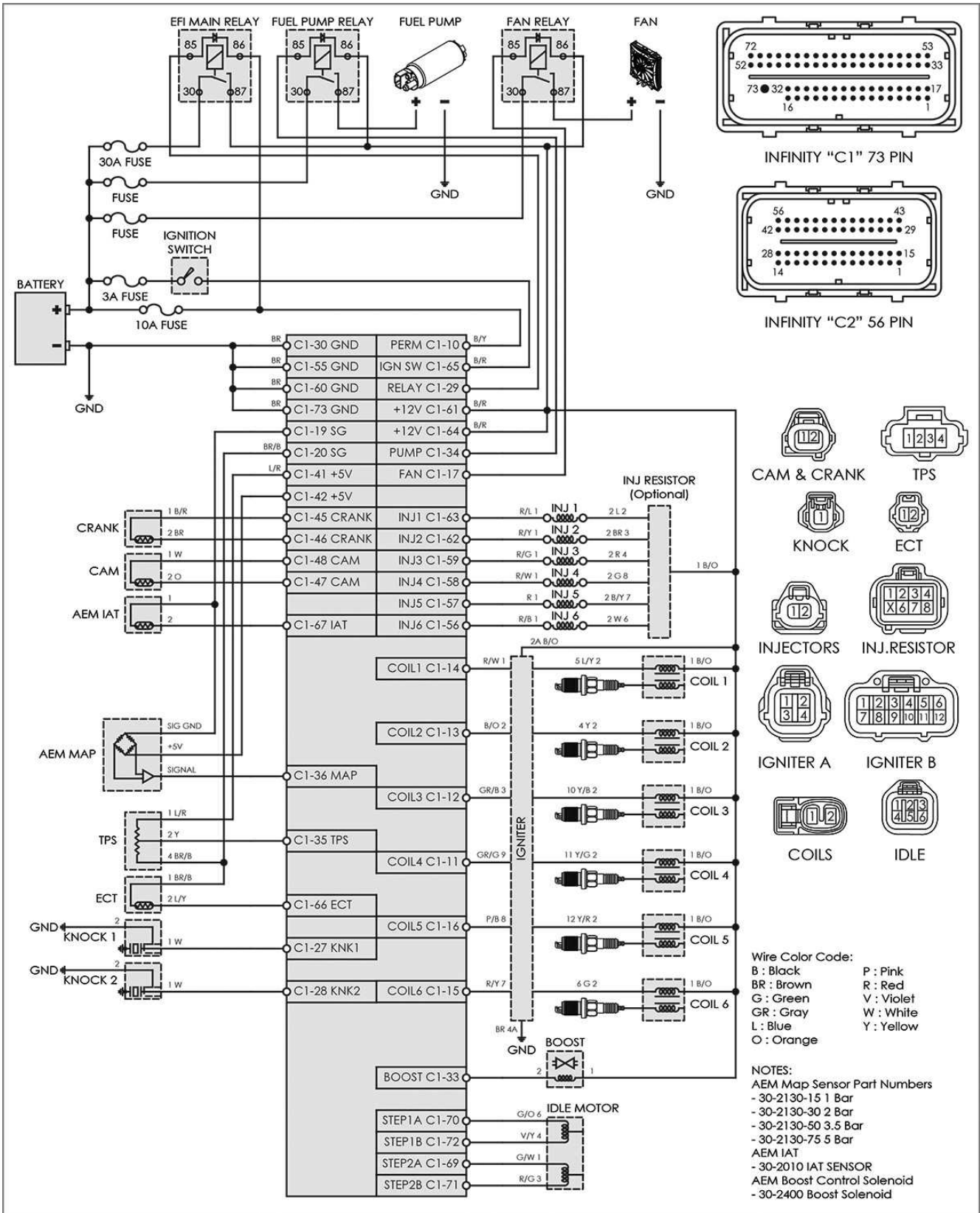

Drawing: 1993-98 Toyota Supra 2JZGTE

ECU: Infinity-8/10/12

Date: 02/24/2014

Rev: A

Engineer: Nakano

Ignition System – COP 2 Wire "Dumb" Coils with Ignitor, Infinity-8/10/12

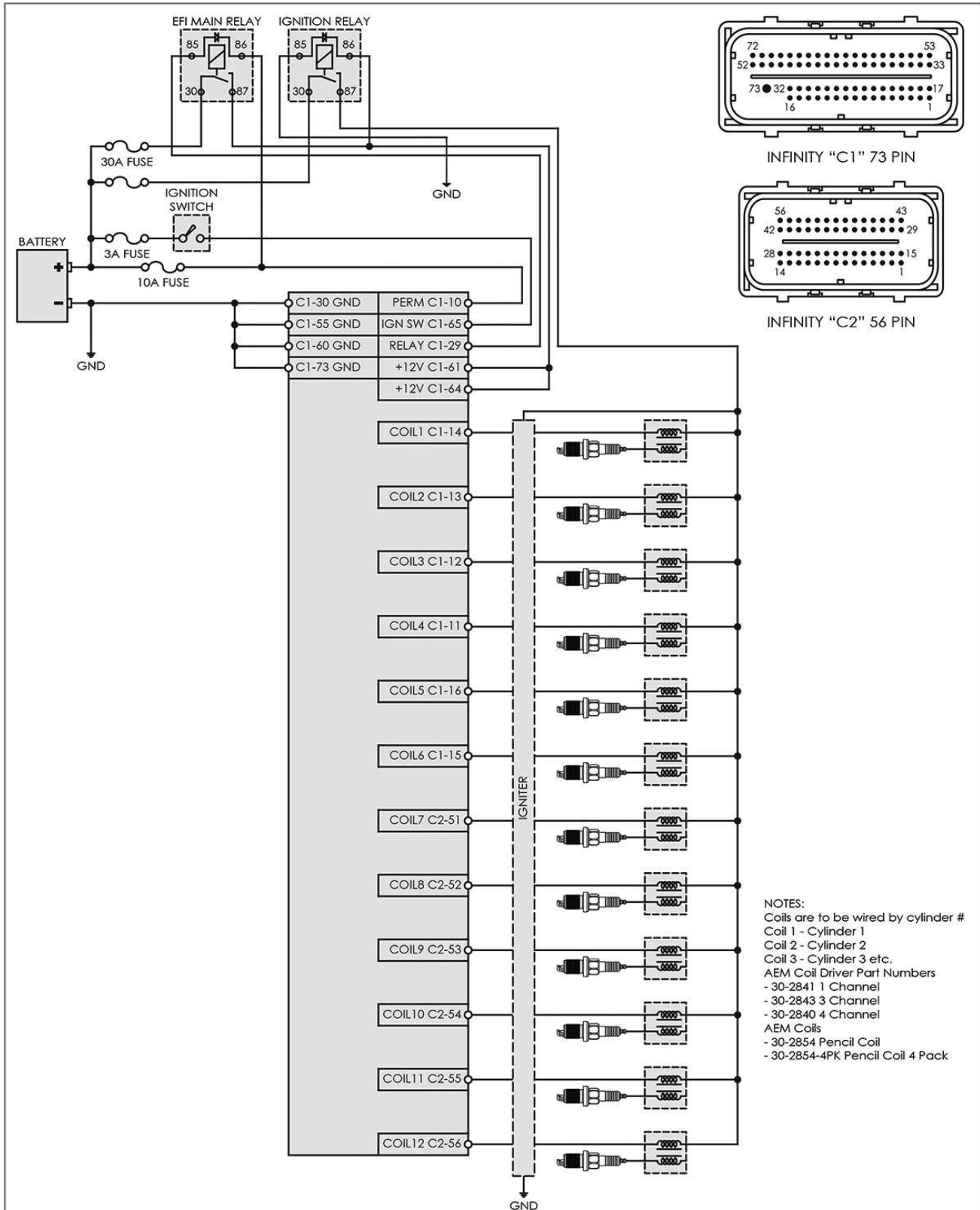

NOTES:
 Coils are to be wired by cylinder #
 Coil 1 - Cylinder 1
 Coil 2 - Cylinder 2
 Coil 3 - Cylinder 3 etc.
 AEM Coil Driver Part Numbers
 - 30-2841 1 Channel
 - 30-2843 3 Channel
 - 30-2840 4 Channel
 AEM Coils
 - 30-2854 Pencil Coil
 - 30-2854-4PK Pencil Coil 4 Pack



Ignition System – COP 3 Wire "Dumb" Coils with Ignitor, Infinity-6/8h

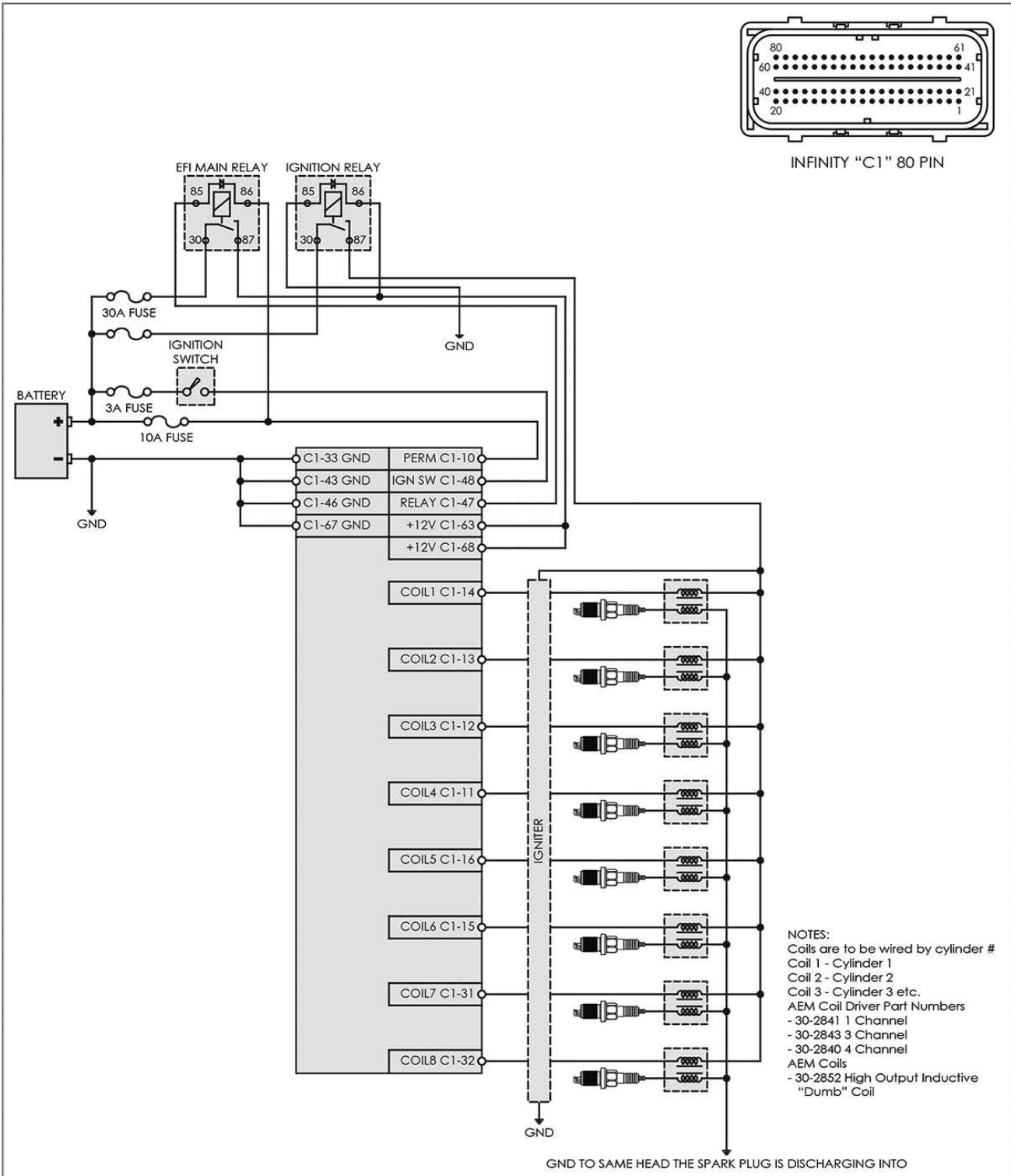

NOTES:
 Coils are to be wired by cylinder #
 Coil 1 - Cylinder 1
 Coil 2 - Cylinder 2
 Coil 3 - Cylinder 3 etc.
 AEM Coil Driver Part Numbers
 - 30-2841 1 Channel
 - 30-2843 3 Channel
 - 30-2840 4 Channel
 AEM Coils
 - 30-2852 High Output Inductive
 "Dumb" Coil



Drawing: Ignition System - COP 3-Wire Dumb Coils with Ignitor

ECU: Infinity-6/8h

Date: 08/07/2014

Rev: A

Engineer: Nakano

Ignition System – COP 3 Wire "Dumb" Coils with Ignitor, Infinity-8/10/12

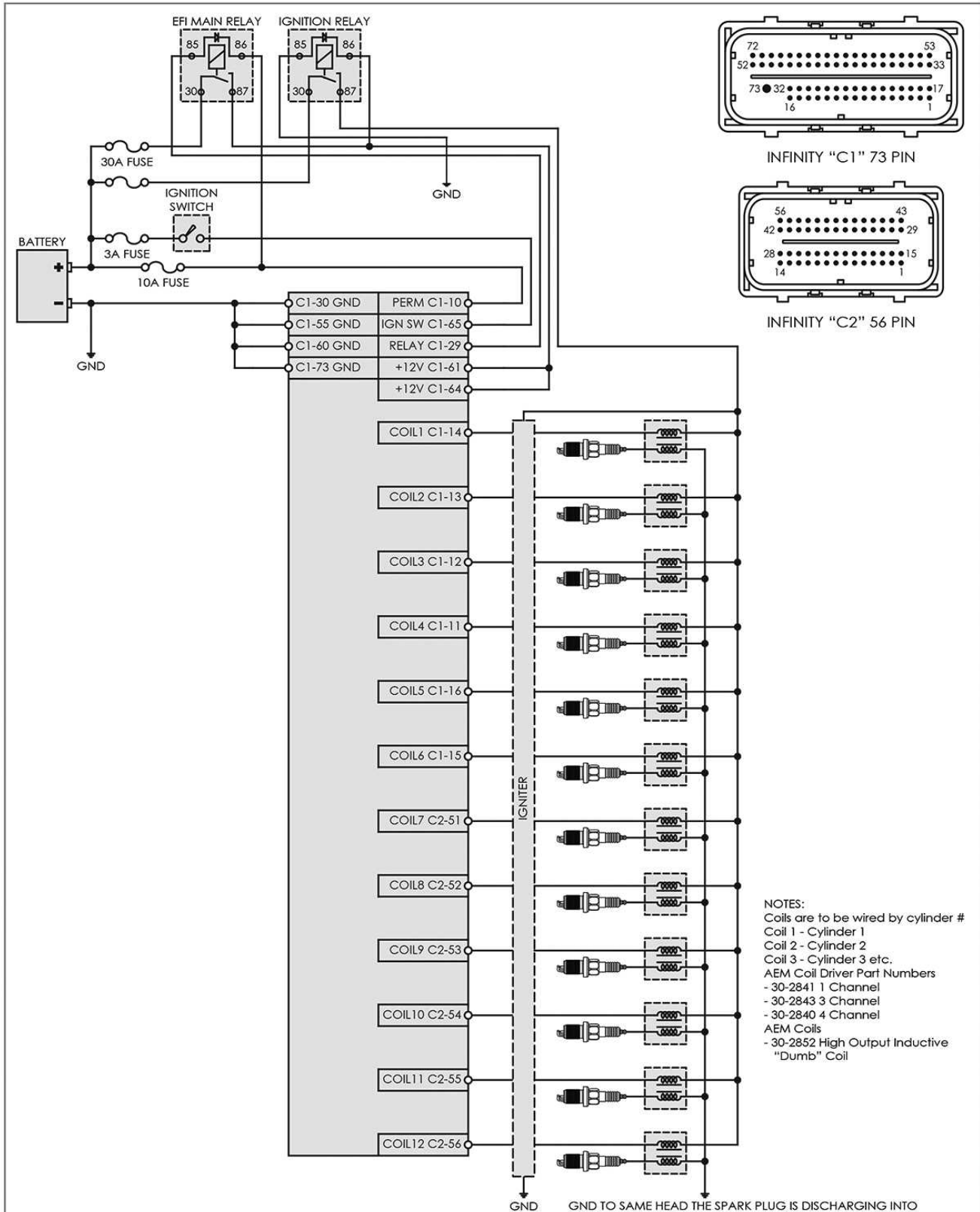

Drawing: Ignition System - COP 3-Wire Dumb Coils with Ignitor

ECU: Infinity-8/10/12 Date: 08/07/2014 Rev: A Engineer: Nakano

Ignition System – COP 3 Wire "Smart" Coils, Infinity-6/8h

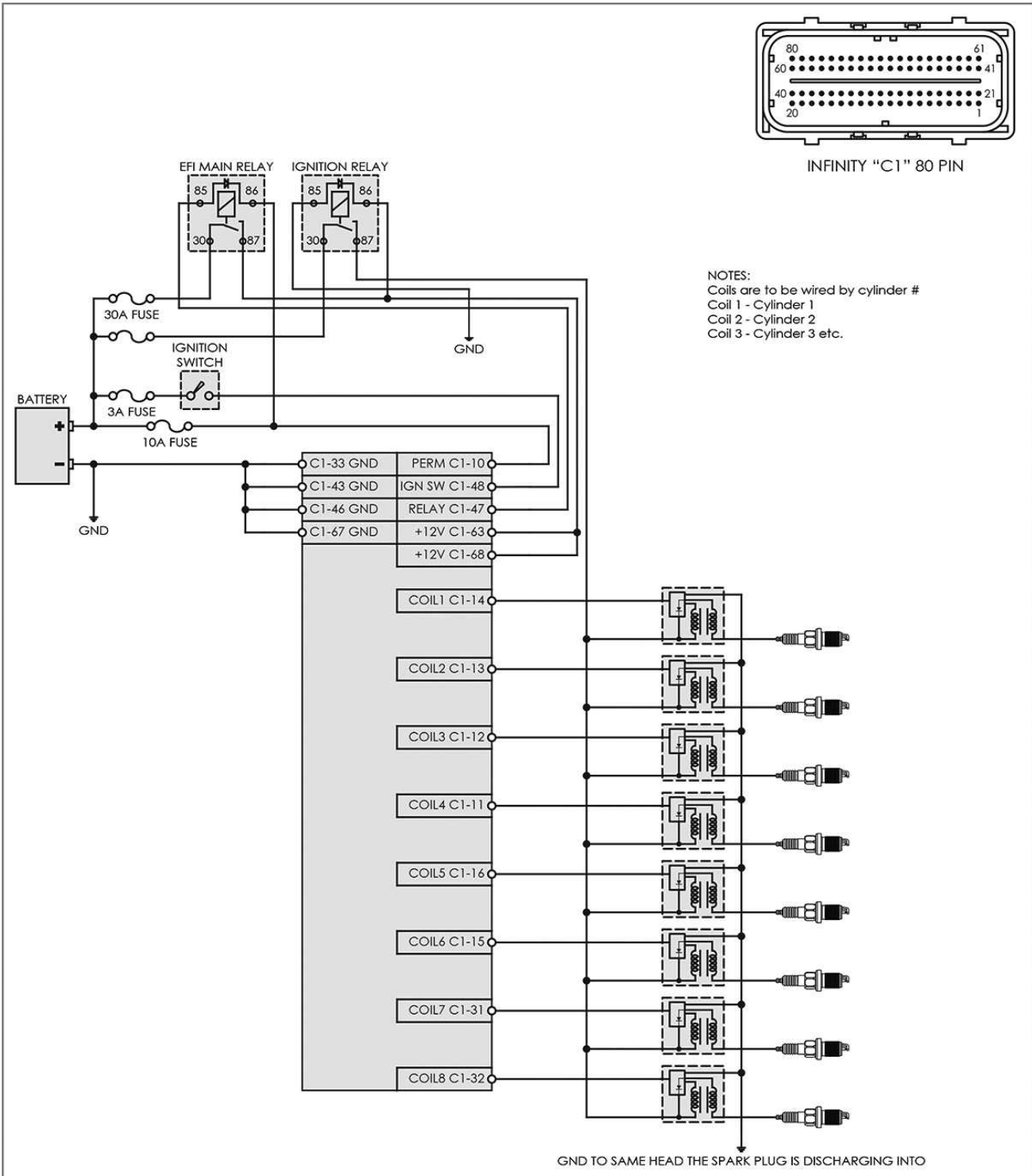

Ignition System – COP 3 Wire "Smart" Coils, Infinity-8/10/12

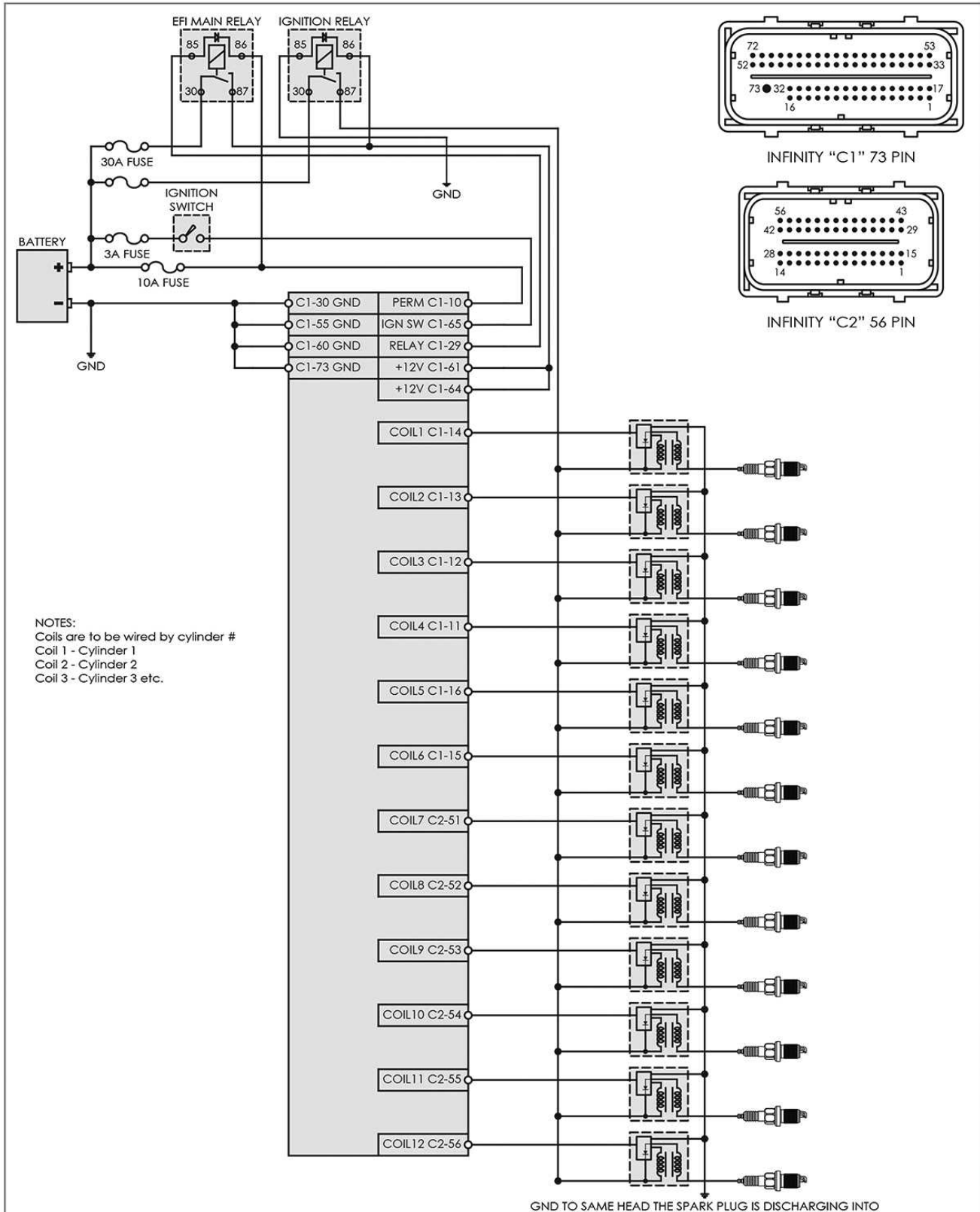

Drawing: Ignition System - COP 3-Wire Smart

ECU: Infinity-8/10/12

Date: 08/06/2014

Rev: A

Engineer: Nakano

Ignition System – COP 4 Wire "Smart" Coils, Infinity-6/8h

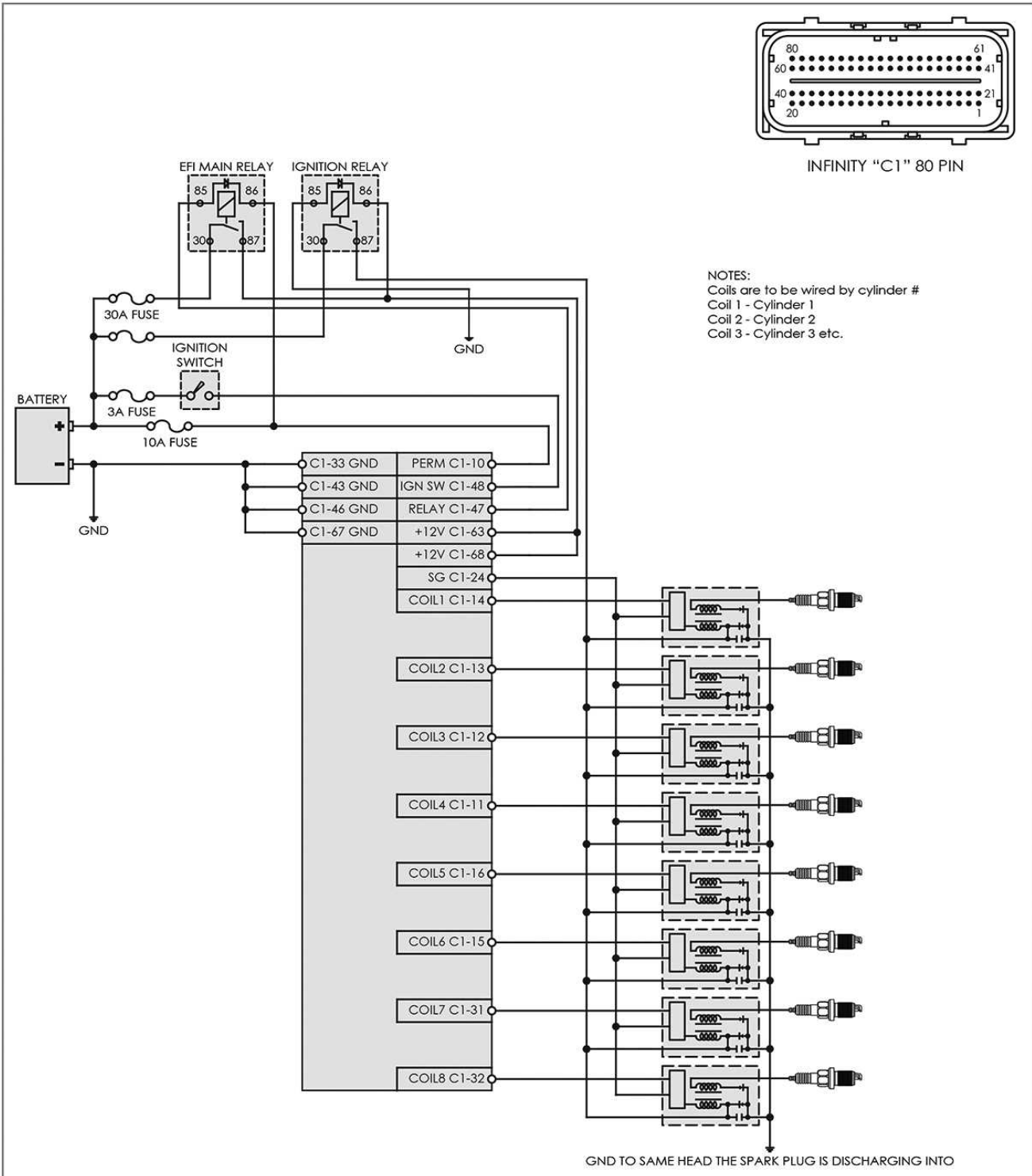

Ignition System – COP 4 Wire "Smart" Coils, Infinity-8/10/12

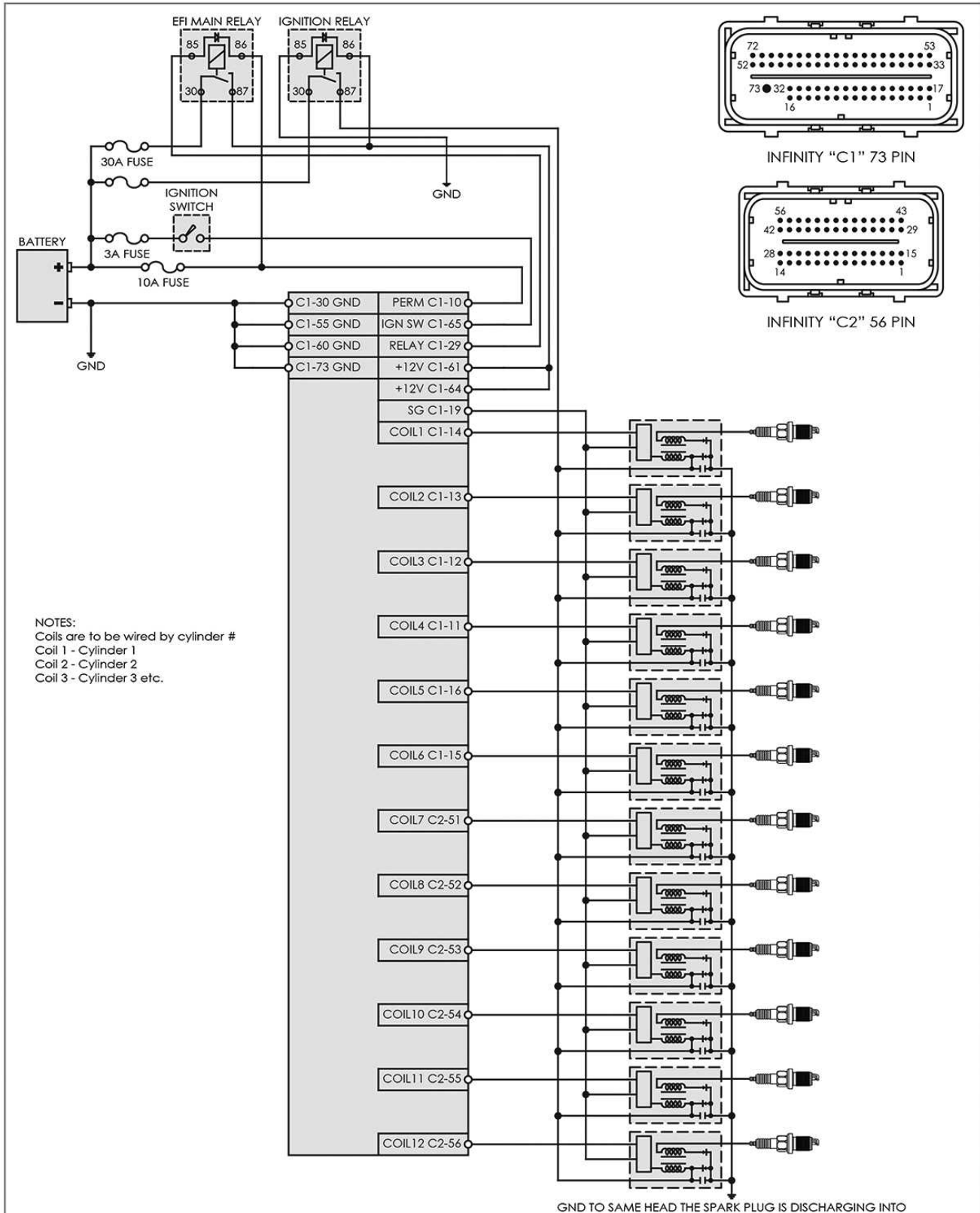

NOTES:
 Coils are to be wired by cylinder #
 Coil 1 - Cylinder 1
 Coil 2 - Cylinder 2
 Coil 3 - Cylinder 3 etc.

GND TO SAME HEAD THE SPARK PLUG IS DISCHARGING INTO



Drawing: Ignition System - COP 4-Wire Smart

ECU: Infinity-8/10/12

Date: 08/07/2014

Rev: A

Engineer: Nakano

Ignition System – COP 5 Wire "Smart" Coils, Infinity-6/8h

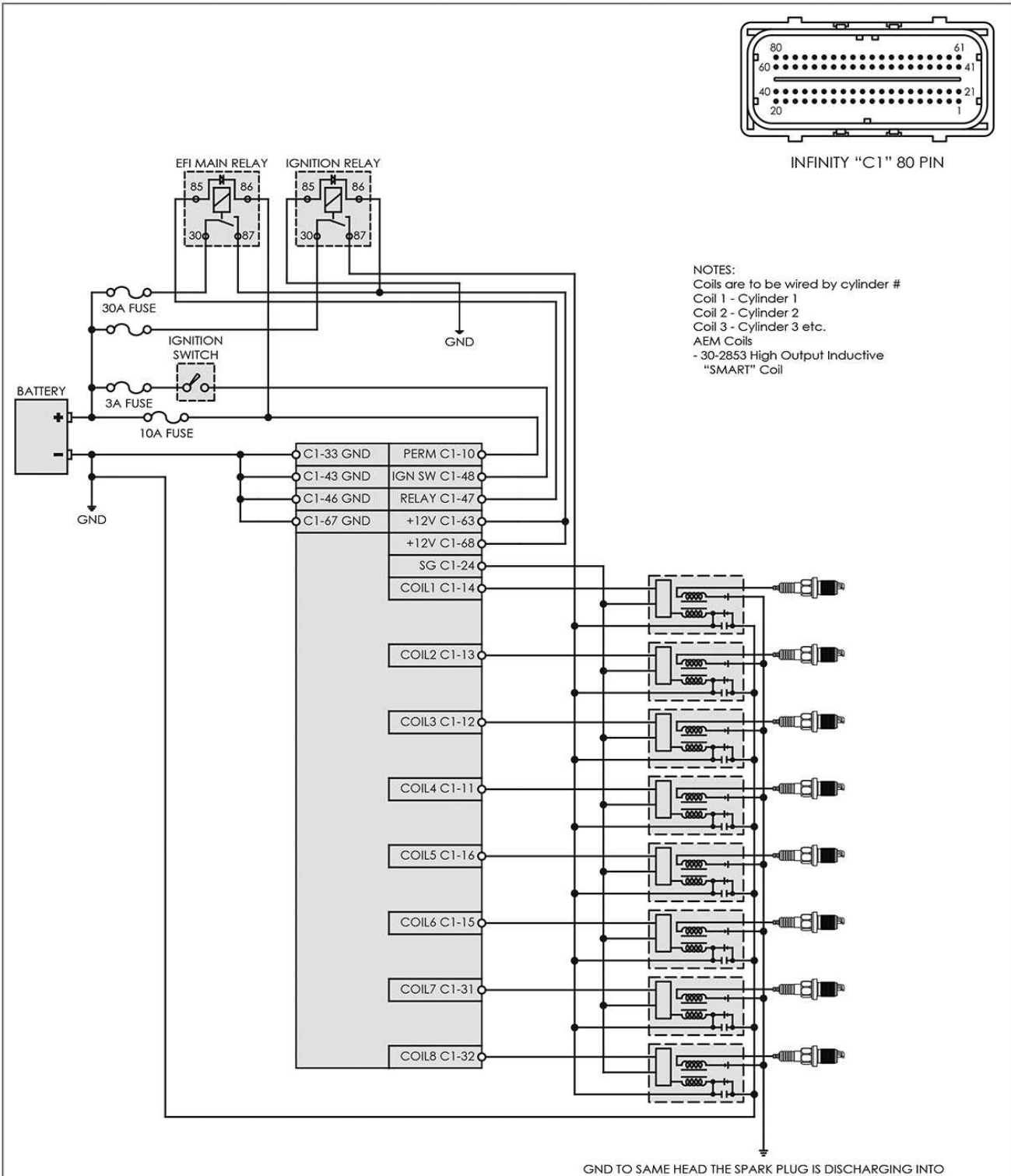

NOTES:
 Coils are to be wired by cylinder #
 Coil 1 - Cylinder 1
 Coil 2 - Cylinder 2
 Coil 3 - Cylinder 3 etc.
 AEM Coils
 - 30-2853 High Output Inductive
 "SMART" Coil



Drawing: Ignition System - COP 5-Wire Smart

ECU: Infinity-6/8h

Date: 10/02/2014

Rev: A

Engineer: Nakano

Ignition System – COP 5 Wire "Smart" Coils, Infinity-8/10/12

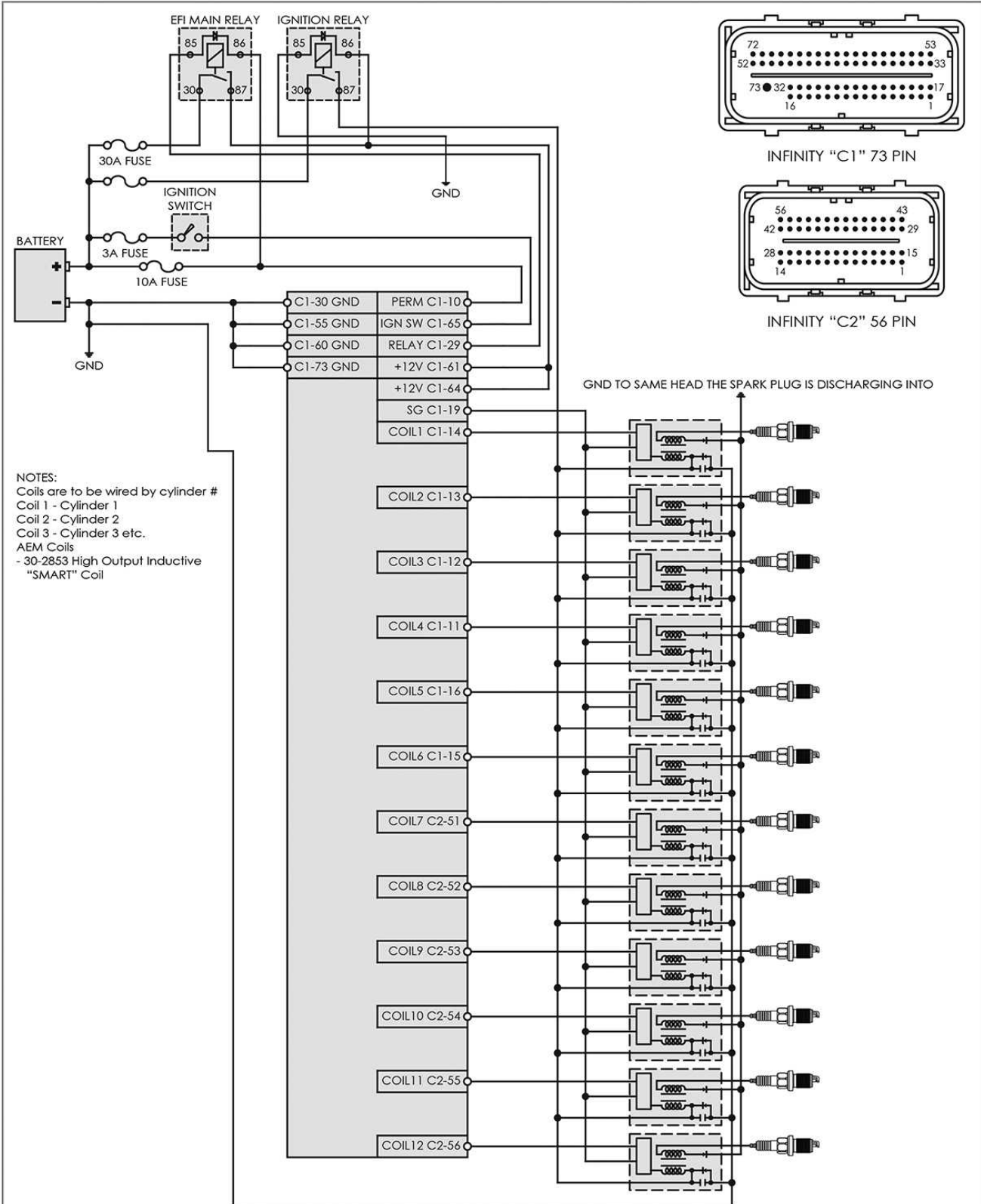

Drawing: Ignition System - COP 5-Wire Smart

ECU: Infinity-8/10/12

Date: 10/02/2014

Rev: A

Engineer: Nakano

GM LS3 DBW Wiring, Infinity-6/8h

ACCELERATOR PEDAL POSITION (APP) SENSOR

GM PIN	INFINITY PIN	WIRE COLOR	FUNCTION
A	C1-23	Purple	Sensor Ground
B	C1-69	Light Blue	Accelerator Pedal Position (APP) Sensor 2 Signal
C	C1-49	Tan	+5 Volt Reference
D	C1-24	Brown	Sensor Ground
E	C1-70	Dark Blue	Accelerator Pedal Position (APP) Sensor 1 Signal
F	C1-50	White/Black	+5 Volt Reference

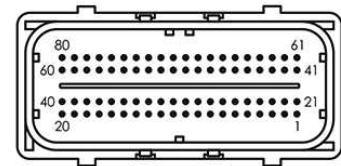

INFINITY "C1" 80 PIN

THROTTLE BODY

GM PIN	INFINITY PIN	WIRE COLOR	FUNCTION
A	C1-61	Brown	Throttle Acuator Control (TAC) Motor Control - 2
B	C1-62	Yellow	Throttle Acuator Control (TAC) Motor Control - 1
C	C1-24	Tan/White	Sensor Ground
D	C1-51	Dark Green	Throttle Position Sensor 1 Signal
E	C1-50	Light Blue/Black	+5 Volt Reference
F	C1-71	Purple	Throttle Position Sensor 2 Signal

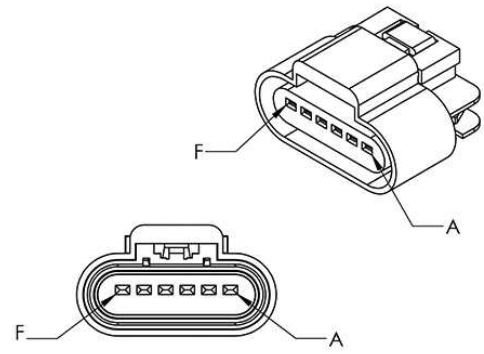
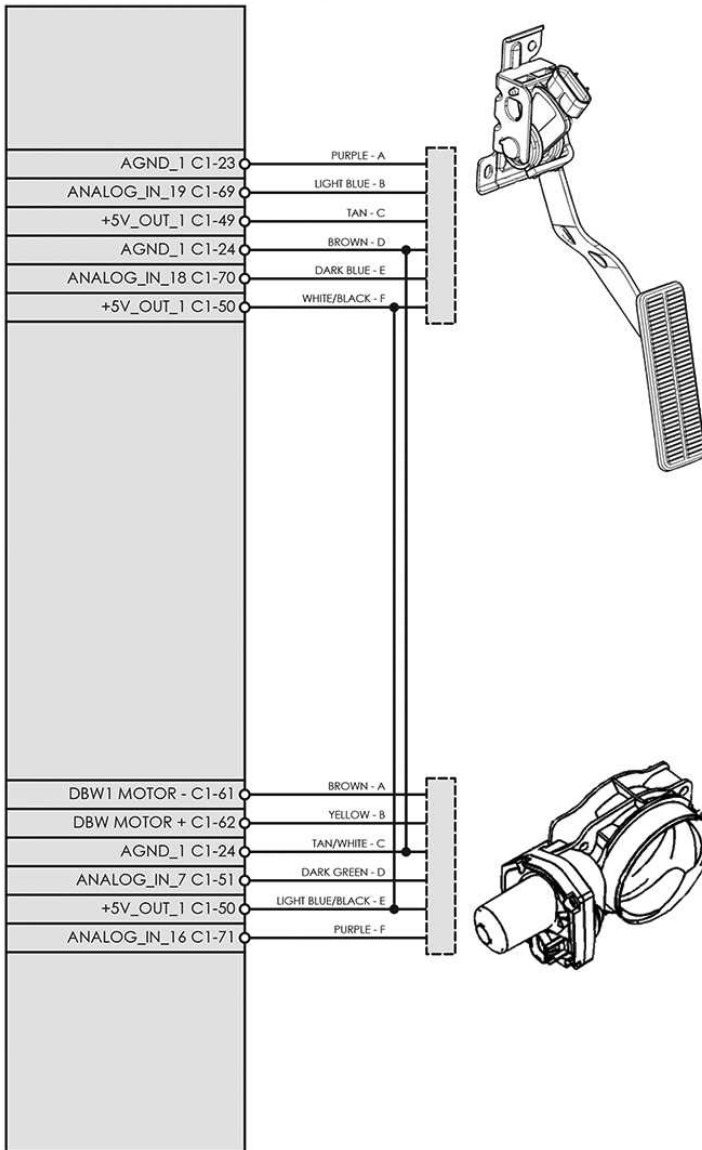

ACCELERATOR PEDAL POSITION (APP) SENSOR

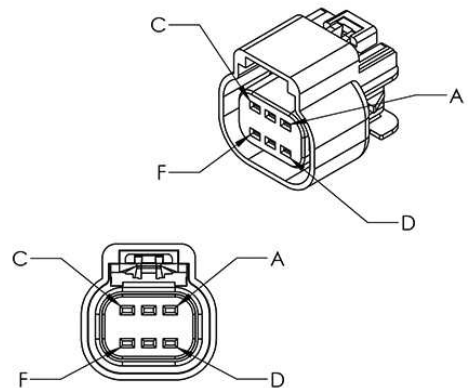

THROTTLE BODY



Drawing: GM LS3 ACCELERATOR PEDAL & DBW THROTTLE BODY

ECU: Infinity-6/8h

Date: 08/04/2014

Rev: A

Engineer: Nakano

GM LS3 DBW Wiring, Infinity-8/10/12

ACCELERATOR PEDAL POSITION (APP) SENSOR

GM PIN	INFINITY PIN	WIRE COLOR	FUNCTION
A	C1-19	Purple	Sensor Ground
B	C2-14	Light Blue	Accelerator Pedal Position (APP) Sensor 2 Signal
C	C1-42	Tan	+5 Volt Reference
D	C1-20	Brown	Sensor Ground
E	C2-13	Dark Blue	Accelerator Pedal Position (APP) Sensor 1 Signal
F	C2-22	White/Black	+5 Volt Reference

THROTTLE BODY

GM PIN	INFINITY PIN	WIRE COLOR	FUNCTION
A	C1-53	Brown	Throttle Acuator Control (TAC) Motor Control - 2
B	C1-54	Yellow	Throttle Acuator Control (TAC) Motor Control - 1
C	C2-30	Tan/White	Sensor Ground
D	C1-35	Dark Green	Throttle Position Sensor 1 Signal
E	C2-23	Light Blue/Black	+5 Volt Reference
F	C2-21	Purple	Throttle Position Sensor 2 Signal

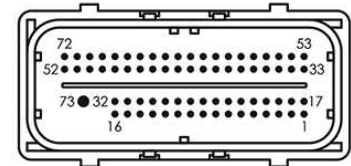

INFINITY "C1" 73 PIN

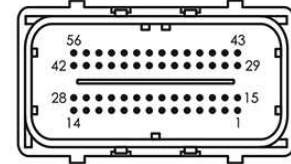

INFINITY "C2" 56 PIN

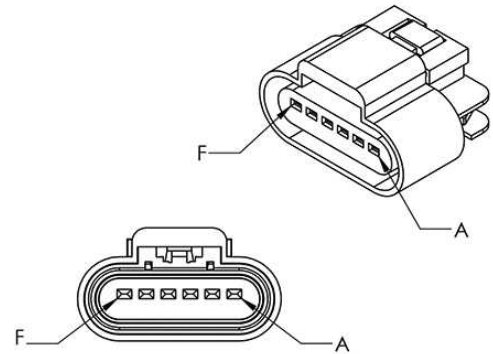
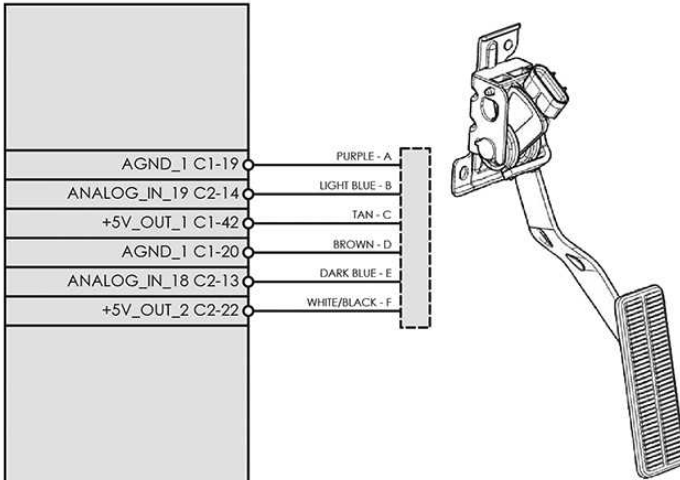

ACCELERATOR PEDAL POSITION (APP) SENSOR

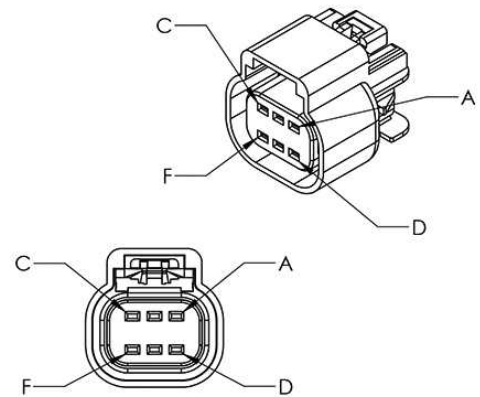
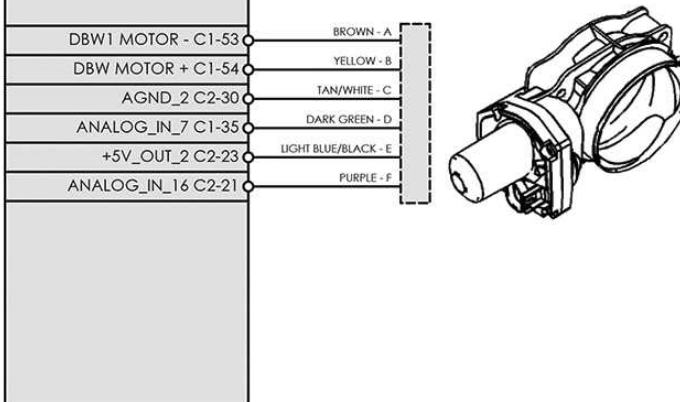

THROTTLE BODY



Drawing: GM LS3 ACCELERATOR PEDAL & DBW THROTTLE BODY

ECU: Infinity-8/10/12

Date: 08/04/2014

Rev: A

Engineer: Nakano

Mazda RX7 FD Wiring, Infinity 6

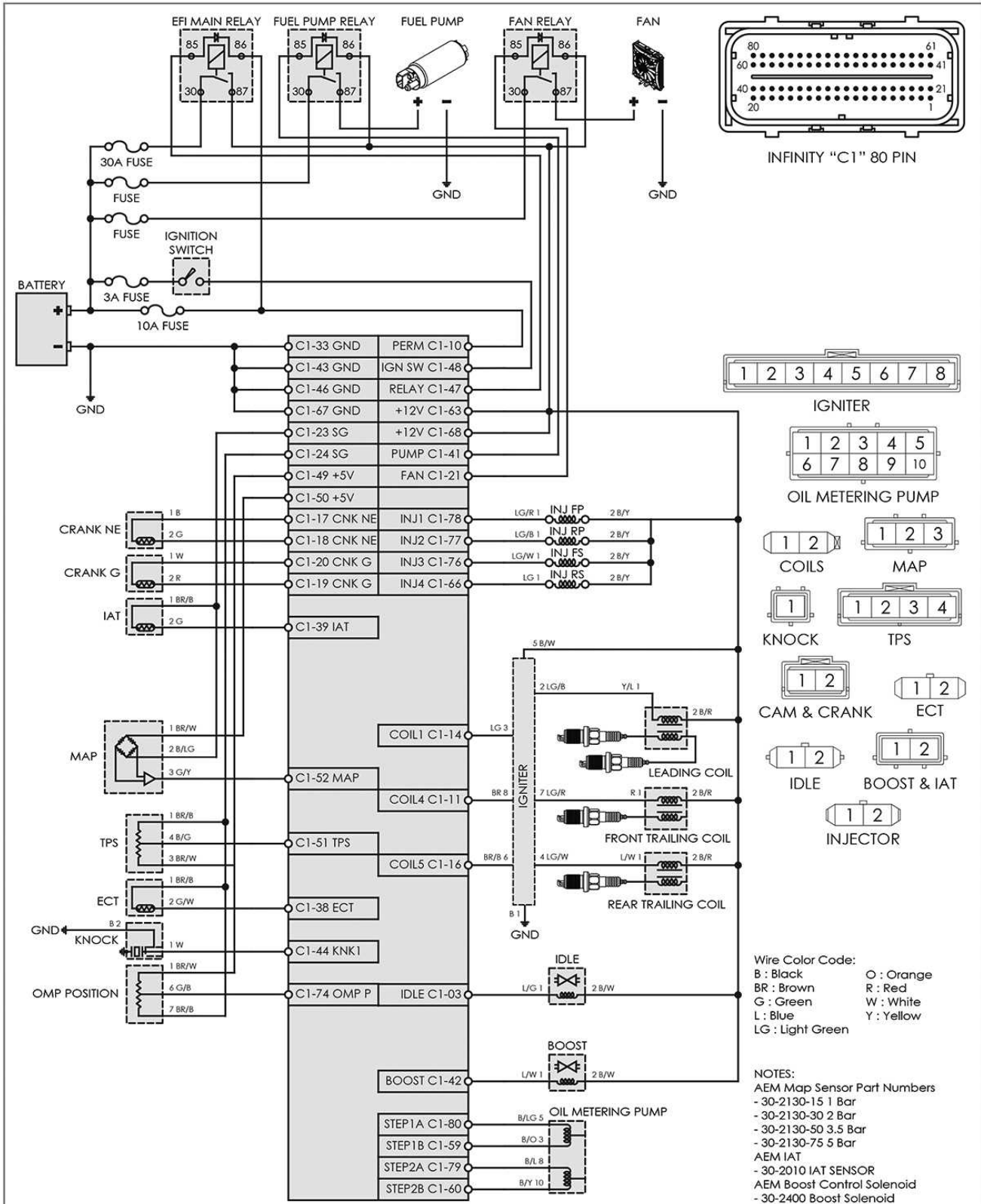

Drawing: 1991-2002 Mazda RX-7 FD

ECU: Infinity-6

Date: 10/01/2014

Rev: A

Engineer: Nakano

Glossary of Terms

Glossary

4 Stroke Cycle

Intake – During the intake stroke, the piston is moving from top to bottom and the intake valve is open. As the piston moves down, a vacuum is created which draws the air/fuel mixture into the combustion chamber. The intake valve is closed after the piston reaches the bottom. This position is normally called bottom dead center (BDC).

Compression – During the compression stroke, the piston moves up and compresses the air/fuel mixture against the cylinder head. When the piston is near the top of the stroke (the top of the stroke is typically called top dead center, TDC), the ignition system produces a spark at the spark plug. The spark ignites the mixture which creates a rapid rise in cylinder pressure.

Power – During the power stroke, the high pressure gases produced by the burning of air/fuel mixture force the piston back down the cylinder bore. This is the only stroke that actually produces useable power from the engine.

Exhaust – During the exhaust stroke, the piston moves upward. The exhaust valve is open and the piston forces the spent gases out the exhaust port and into the exhaust system.

5 Volt Reference

The high voltage reference for most automotive analog sensors. Typical three-wire sensors will have a high reference, a low reference and a signal output. The signal output will always fall between the low and high reference points.

Air / Fuel Ratio

In engine testing, both the air mass flow rate and the fuel mass flow rate are normally measured. The ratio of these flow rates is useful in defining engine operating conditions. The normal operating range for a conventional spark ignited gasoline burning engine is between 12:1 and 18:1. Turbo/supercharged engines typically operate even richer with air/fuel ratios as low as 11:1. The most common way to measure Air/Fuel ratio for engine calibration work is by using an oxygen sensor in the exhaust stream.

Analog Circuits

Electrical circuits that amplify or alter a voltage signal to represent some physical quantity

Atmospheric Pressure

Normal pressure in the surrounding atmosphere generated by the weight above us pushing down. At sea level, in average weather conditions, atmospheric pressure is approximately 100 kPa (about 14.5 psi) above vacuum or zero absolute pressure.

Base Idle

Idle RPM when the throttle lever is at rest on the throttle stop and the idle speed control function is disabled

BDC

Bottom dead center; the extreme lowest position of the piston during its stroke

Boost

Describes positive pressure in the intake manifold relative to atmospheric pressure. Standard atmospheric pressure is 14.5 psia. 10 psi of boost would result in 24.5 psia in the manifold.

Breakpoints

Define the axis values on two dimensional or three dimensional lookup tables

BSFC

Brake Specific Fuel Consumption or BSFC is the fuel flow rate per unit power output. It measures how efficiently an engine is using the fuel supplied to produce work.

Calibration

Engine calibration in its most basic form is the setting of the air/fuel ratio and ignition timing for the engine. Modern electronic engine control systems serve many more functions though. These can include: idle control, automatic transmission control, turbocharger boost control and knock control. The engine controller can also be used to enable/disable ancillary functions like emissions control solenoid valves (EVAP/purge, air injection), air conditioner compressor clutch relays, etc. The engine calibrator is responsible for configuring and tuning all of these items to satisfy the performance requirements for the engine.

Capacitor

An electronic device that stores electrical charge

Closed Loop Fuel Control

An engine control mode of operation where the air/fuel ratio is controlled by varying the fuel flow rate in response to the rich/lean indication from an exhaust

Coil

For ignition system is comprised of two sets of insulated wire wound around a common ferrous core. The primary winding is typically made up of tens or hundreds of turns of course wire. The secondary winding is made up thousands of turns of fine wire. A single set of coil windings can be used to build a solenoid that converts electrical field energy into mechanical movement.

Coil on Plug

Refers to ignition systems that include one coil for each spark plug. Most modern automotive ignition systems are of this type.

Cold Start

Starting the engine when it is cold, when the engine has not run for several hours

Combustion

The burning of the fuel-air mixture in the cylinder

Combustion Chamber

Space left between the cylinder head and the top of the piston at TDC; where combustion of the air-fuel mixture takes place

Compression Ratio

The ratio of the cylinder volume at BDC to the volume at TDC

Options

Single value in an engine calibration. Can sometimes be referred to as an option. Options and tables (2D and 3D) make up the tunable portion of an engine calibration file.

Continuity

Little or no resistance in an electrical circuit to the flow of current. A solid electrical connection between two points in a circuit. The opposite of an open circuit.

Controller

In automotive electronics, refers to a module made up of semiconductor circuits sometimes containing embedded software code

Data

Information calculated or obtained directly from sensor inputs to a controller

Data Analysis

The task of interpreting information obtained from engine sensors and controller calculations

Density

The ratio of the mass of something to the volume it occupies. Air has less density when it is warm and less density at higher altitudes.

Digital Circuit

Electronic circuits whose outputs can change only by specific amounts and between a limited number of different voltages

Stoichiometric

The air/fuel ratio for complete combustion; all the fuel is burned using exactly all the oxygen in the air. For gasoline, this ratio is 14.7:1 or 14.7 parts of air to 1 part fuel.

Display

Device used to indicate information in a human-readable form

Drivability

Condition describing a car in which it starts easily and idles, accelerates and shifts smoothly and with adequate power for varying temperatures

Driver

In automotive electronics, refers usually to a transistor circuit that is designed to either source or sink electrical current

Duty Cycle

In components which cycle on and off at a given frequency, the measurement of the amount of time the component is on versus the time it is off

Dwell

The amount of time that current is flowing through the primary side of the ignition coil. Dwell measurements can be expressed in either units of time (usually milliseconds) or crankshaft degrees.

ECU

Engine Control Unit. Refers to an electrical module that receives inputs from sensors and outputs signals to actuators on an engine. Can also be referred to as EMS, PEMS, etc.

Emissions

Chemical by-products of combustion; comprised primarily of carbon monoxide (CO), hydrocarbons (HC) and nitrous oxides (NOX)

Engine Calibration

The values contained in the controller program that are adjustable by the tuner and are used to control engine operation, primarily fuel and spark requirements

Engine Mapping

A procedure of experimentally determining the performance of an engine at selected operating points and recording the results

Equivalence Ratio

Actual air/fuel ratio divided by the air/fuel ratio at stoichiometry

Export

To output information or data from one piece of computer software for use in another

Gain

In closed loop control terminology, refers to constants that vary the magnitude of each term in the manipulated variable calculation or algorithm

Hall Effect Position Sensor

Type of sensor used in all Pro Flo distributors for measuring crankshaft position; outputs a square wave signal pattern that is either low (ground) or high (reference voltage) depending on whether or not a tooth is passing near the sensor

Hg

The chemical representation for the element Mercury

High Impedance

Refers to injectors that have coil resistance values of 12.0 ohms or more

Hot Keys

Single or combinations of key strokes that can be programmed to perform certain tasks

Import

To receive information or data from one piece of computer software for use in another

Inches Hg

A relative measure of pressure or vacuum

Injector

Solenoid actuated fixed orifice valve used to inject precise amounts of fuel

Integrated Circuit

A semiconductor device that contains many circuits on a single chip

Lambda

Term referring to the oxygen sensor itself or the data obtained from an oxygen sensor that represent the air/fuel ratio of the engine. The lambda value is a ratio and is therefore unit-less.

Load

In fuel injection calibrations, a term used to scale the demand on an engine. Commanded fuel, spark and other variables are assigned in the calibration file based on the load and current operating mode of the engine.

Lookup Table

A table in software that equates one variable to another

Low Impedance

Refers to injectors that have coil resistance values of 2.5–3.0 ohms

Macro

A feature of some computer software programs that allows a number of repeated tasks to be combined and performed on command

Math Channel

In data analysis software, a channel calculated using raw data and mathematical functions; can be included in a plot with other data

mS

Abbreviation for millisecond or one thousandth; 0.001 seconds

Open Loop Fuel Control

Method of controlling fuel flow without modification from a feedback variable such as oxygen content

Outing

In data analysis software, refers to a complete set of data

Parallel Circuit

Contains two or more circuit elements that have the same voltage measured across each

Peak and Hold Driver

A driver that uses two levels of current to operate the injector. The driver circuit applies battery voltage to the injector until a predetermined current level is reached. The current is then reduced and held at a lower level for the duration of the PW. This type of driver is normally used with injectors having low resistance coils (typically around 2 ohm). The accuracy of the driver peak current level (Ip) and the hold current level (Ih) is held to $\pm 0.50\%$.

Permanent Power

Sometimes referred to as "Perm" power. This is uninterrupted battery power, typically a direct connection to the battery positive terminal.

Pickup

Term that sometimes refers to frequency measurement sensors such as crank or cam position

Pigtail

One or more wires terminated only on one end. Sometimes specialized automotive connectors are supplied with a short piece of wire installed in each cavity. Can be spliced into an existing harness.

Pinout

Refers to the description of each circuit or pin on a connector

Power

Power is the rate at which work is done. It is the product of torque and angular speed.

psi

Abbreviation for pounds per square inch, a unit of pressure measurement

psia

Abbreviation for pounds per square inch absolute; a unit of pressure measurement relative to a perfect vacuum

RS232

A common standard used in serial communication between a PC and an engine controller

RXD

Abbreviation for Receive Data

Saturated Driver

A power transistor driver that turns fully on for the entire duration of the injector PW. This type of driver is used with injectors having high resistance coils (typically 12 to 16 ohm) or with injectors having low resistance coils in combination with a ballast resistor.

Sensor Calibration

Sensors used on EFI systems output a voltage that is proportional to whatever the sensor is monitoring, manifold pressure, coolant temperature, etc. A calibration curve is a 2-dimensional lookup table that assigns sensor voltage settings to values in particular engineering units. Manifold pressure will be calibrated in units of pressure; coolant temperature will be calibrated in units of temperature, either Fahrenheit or Celsius, etc.

Sensor Ground

Also known as analog ground or low reference. The voltage output from a sensor is always relative to some reference. Most analog sensors use a clean 5 volt high reference and a clean low reference or sensor ground. Sensor grounds are actually outputs from the ECU. The engine controller isolates and filters these reference grounds so they are not affected by stray electrical noise.

Serial

In communication hardware, serial refers to sending data sequentially, one bit at a time over a communication channel or cable.

Series Circuit

Two or more circuit elements are said to be in series if the same current flows through each of the elements.

Spark Timing

Time measured in degrees of crankshaft rotation between the spark plug firing event and top dead center for that cylinder.

Stoichiometric

The air/fuel ratio for complete combustion; all the fuel is burned using exactly all the oxygen in the air. For gasoline, this ratio is 14.7:1 or 14.7 parts of air to 1 part fuel.

Switch

A device that can break an electrical connection interrupting the current or diverting it from one conductor to another

Switched Ground

Using an electromechanical or electronic switch to connect a circuit element to a ground reference

Switched Power

Battery power provided to the system when the ignition switch is in both the "run" and "start" positions

Tile

Software feature allowing multiple windows to be displayed at once

Torque

Torque is a measure of an engine's ability to do work. Engine torque is normally measured with an engine dynamometer.

Trims

Alternate term used to describe correction tables in an engine calibration file

TXD

Abbreviation for Transmit Data

uS

Abbreviation for microsecond or one ten thousandth of a second or 0.0001 seconds

USB

Universal Serial Bus (USB) is a serial bus standard to connect devices to a computer. Other convenient features include providing power to low-consumption devices, eliminating the need for an external power supply, and allowing many devices to be used without requiring manufacturer-specific device drivers to be installed.

Vacuum

Vacuum is measured in units of pressure. In automotive technology, vacuum is often measured using inches of mercury on the barometric scale or as a percentage of atmospheric pressure in bars or atmospheres. Low vacuum is often measured in inches of mercury (inHg) below atmospheric pressure. "Below atmospheric" means that the absolute pressure is equal to the current atmospheric pressure (e.g., 29.92 inHg) minus the vacuum pressure in the same units. Thus a vacuum of 26 inHg is equivalent to an absolute pressure of 4 inHg (29.92 inHg - 26 inHg). The reciprocating motion of the pistons in an internal combustion engine create a vacuum in the manifold.

Volumetric Efficiency

The intake system on a spark ignited engine, restricts the amount of air that an engine of a given displacement can flow. The parameter used to measure the effectiveness of an engine's induction process is the volumetric efficiency. It is defined as the volume flow rate of air into the intake system divided by the rate at which volume is displaced by the piston.

Wasted Spark

A wasted spark is when in an ignition system in a four-stroke cycle internal combustion engine spark plugs fire in pairs, on both the exhaust and compression strokes. The extra spark on the exhaust stroke has no effect and is thus "wasted." This design is simpler than a conventional ignition system, but the extra sparks reduce the lifespan of components (contact breaker, spark plugs).

XY Plot

In data analysis, a plot of one variable versus another rather than time