

# LoadLifter 5000™ SERIES



## Installation Guide



*Ford F150*



**Watch the video**

Info on Table of Contents page

# Kits 57355 | 88355 | 89355

For maximum effectiveness and safety, please read these instructions completely before proceeding with installation.

Failure to read these instructions can result in an incorrect installation.

# **Protect your Air Lift Purchase by Completing your Warranty Registration**



Thank you for purchasing an Air Lift load support product!

Take a photo of your sales receipt before scanning the QR code as it is required to complete the warranty registration. Scan the QR code to register the warranty online.

Your registration also helps us to keep you up to date on product information and offers.

## TABLE OF CONTENTS

<b>Installation Diagram</b> . . . . .	<b>2</b>
<b>Hardware and Tools Lists</b> . . . . .	<b>3</b>
<b>Introduction</b> . . . . .	<b>4</b>
Notation Explanation . . . . .	4
Identifying the Differences Between Kits . . . . .	4
<b>Installing the System</b> . . . . .	<b>5</b>
Preparing the Vehicle . . . . .	5
<b>Installing the Air Lines</b> . . . . .	<b>13</b>
Installing Nylon Air Lines . . . . .	13
Installing Braided Stainless Steel Air Lines . . . . .	14
Installation Checklist . . . . .	15
Maintenance and Use Guidelines . . . . .	15
<b>Limited Warranty and Return Policy</b> . . . . .	<b>15</b>

## Video-enhanced installation guides

Visit [airliftcompany.com/workshop/category/install-videos](http://airliftcompany.com/workshop/category/install-videos) to access our installation video archive\*.

# Installation Diagram

Driver's (left) side shown

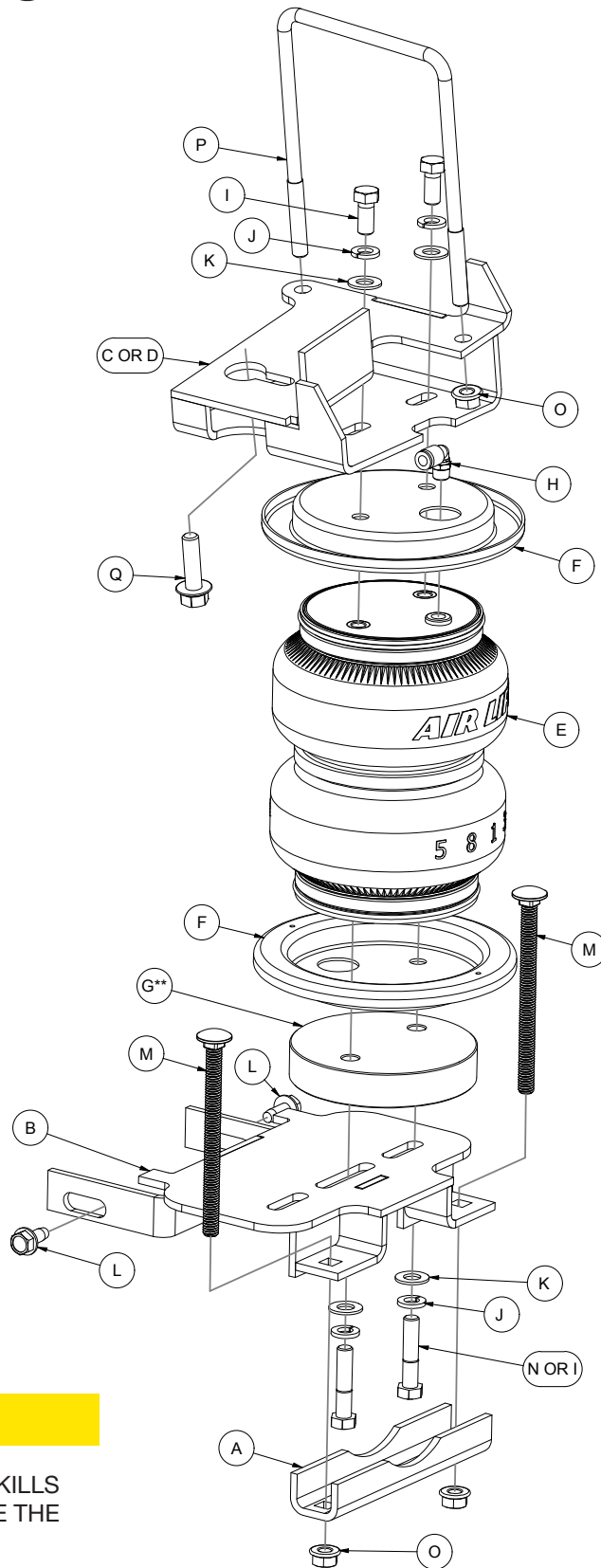

**CAUTION**

PROFESSIONAL MECHANIC SKILLS ARE REQUIRED TO COMPLETE THE INSTALLATION OF THIS KIT.

\*\* Optional: May not be required for your installation. See page 7.

Fig. 1

# Hardware and Tools Lists

## Common Parts Included in All 3 Kits

Item	Part#	Description	Qty
A	01531	Clamp bar	2
B	03977	Lower bracket	2
C	07555	Upper left bracket	1
D	07999	Upper right bracket	1
G**	11387	Lower spacer	2
H	21848	1/4" Air fitting	2
K	18444	3/8" Flat washer	9
L	17102	5/16"-18 x 3/4" Self-threading screw	4
M	17168	3/8"-16 x 5" Carriage bolt	4
O	18422	3/8"-16 Serrated flange nut	8
P	11325	3/8"-16 U-bolt	2
Q	17268	M10 x 1.5 x 35mm Flange bolt	2
R*	11149	Left-hand wiring harness bracket	1
S*	11150	Right-hand wiring harness bracket	1
T*	17175	1/4"-20 X 3/4" Hex-cap screw	1
U*	17187	3/8"-16 X 7/8" Hex-cap screw	1
V*	18419	1/4" Flat washer	1
X*	18425	1/4" Nylon lock nut	1
Y*	18435	3/8" Nylon lock nut	1
AA*	20086	Air line assembly	1
BB*	10466	Zip ties	6
CC*	18411	5/16" Lock washer	2
DD*	21234	Rubber washer	2
EE*	18501	M8 Flat washer	2
FF*	21233	5/16" Hex nut	4
GG*	21230	Valve cap	2

\* These parts are not shown in the Installation Diagram (Fig. 1).

\*\* Optional: May not be required for your installation. See page 7.

## TOOLS LIST

Description	Qty
Standard and metric open-end or boxed wrenches	Set
Standard and metric regular and deep-well sockets	Set
Ratchet	1
Torque wrench	1
7/32" Hex-key wrench (socket preferable)	1
Hose cutter, razor blade, or sharp knife	1
Cutoff wheel, air reciprocating saw or a hacksaw	1
Christmas tree puller	1
Hoist or floor jack	1
Safety stands	2
Safety glasses	1
Air compressor or compressed air source	1
Spray bottle with dish soap/water solution	1

The photos in this manual show the LoadLifter 5000 Ultimate kit.

## Unique Parts in Each Kit

### LoadLifter 5000™ KIT 57355

Item	Part#	Description	Qty
E	58437	Air spring	2
F	11951	Roll plate	4
I	17203	3/8"-24 x 7/8" Hex-head screw	8
J	18427	3/8" Lock washer	8
N	17484	3/8"-24 x 1 3/4" Hex-head screw	4

### LoadLifter 5000™ ULTIMATE KIT 88355

Item	Part#	Description	Qty
E	58496	Air spring	2
F	11967	Roll plate	4
I	17203	3/8"-24 x 7/8" Hex-head screw	8
J	18427	3/8" Lock washer	8
N	17484	3/8"-24 x 1 3/4" Hex-head screw	4

### LoadLifter 5000™ ULTIMATE PLUS+ KIT 89355

Item	Part#	Description	Qty
E	58496	Air spring	2
F	11880	Roll plate (stainless steel)	4
I	17284	3/8"-24 x 7/8" Stainless steel hex-head bolt	8
J	18504	3/8" Stainless steel lock washer	8
K	18507	3/8" Stainless steel flat washer	8
N	17585	3/8"-24 x 1 3/4" Stainless steel hex-head screw	4
HH*	20987	Stainless steel braided air line	2



Missing or damaged parts? Call Air Lift customer service at (800) 248-0892 for a replacement part.

# Introduction

The purpose of this publication is to assist with the installation and maintenance of the LoadLifter 5000 series air spring kits. All LoadLifter 5000 series kits utilize sturdy, reinforced, commercial-grade single or double, depending on the kit, convolute bellows.

The air springs are manufactured like a tire with layers of rubber and cords that control growth. LoadLifter 5000 kits provide up to 5,000 pounds (2,268kg) of load-leveling support with air adjustability from 5-100 PSI (.34-7BAR).

It is important to read and understand the entire installation guide before beginning installation or performing any maintenance, service or repair.

## NOTATION EXPLANATION

Hazard notations appear in various locations in this publication. Information which is highlighted by one of these notations must be observed to help minimize risk of personal injury or possible improper installation which may render the vehicle unsafe. Notes are used to help emphasize areas of procedural importance and provide helpful suggestions. The following definitions explain the use of these notations as they appear throughout this guide.

**DANGER**

INDICATES IMMEDIATE HAZARDS WHICH WILL RESULT IN SEVERE PERSONAL INJURY OR DEATH.

**WARNING**

INDICATES HAZARDS OR UNSAFE PRACTICES WHICH COULD RESULT IN SEVERE PERSONAL INJURY OR DEATH.

**CAUTION**

INDICATES HAZARDS OR UNSAFE PRACTICES WHICH COULD RESULT IN DAMAGE TO THE MACHINE OR MINOR PERSONAL INJURY.

## IDENTIFYING THE DIFFERENCES BETWEEN KITS

Should you need to contact Air Lift customer service, you will need to know which kit you are inquiring about: standard LoadLifter 5000, LoadLifter 5000 Ultimate or LoadLifter 5000 Ultimate Plus. The kits are easily identifiable by looking at the roll plates and air lines.

- Standard **LoadLifter 5000** — Zinc-plated steel roll plates and black nylon air lines.
- LoadLifter 5000 Ultimate** — Black powder-coated roll plates and black nylon air lines.
- LoadLifter 5000 Ultimate Plus** — Stainless steel roll plates, braided stainless steel air lines, stainless steel air spring mounting hardware.



LoadLifter 5000  
silver zinc-plated steel  
roll plate



LoadLifter 5000  
nylon air line



LoadLifter 5000 Ultimate  
black powder-coated roll plate



LoadLifter 5000 Ultimate  
nylon air line



LoadLifter 5000 Ultimate Plus  
stainless steel roll plate



LoadLifter 5000 Ultimate PLUS  
braided stainless steel air line

Air Lift offers two Ultimate Plus upgrade kits:

**52300** - Braided stainless steel air line and fittings.

**52301** - Stainless steel roll plates, air spring mounting hardware, braided stainless steel air lines and fittings.



# Installing the System

## PREPARING THE VEHICLE

1. Lift the vehicle and support the frame with safety stands. Drop the axle down low enough to later set the air spring assemblies into position between frame and leaf spring (Fig. 2).

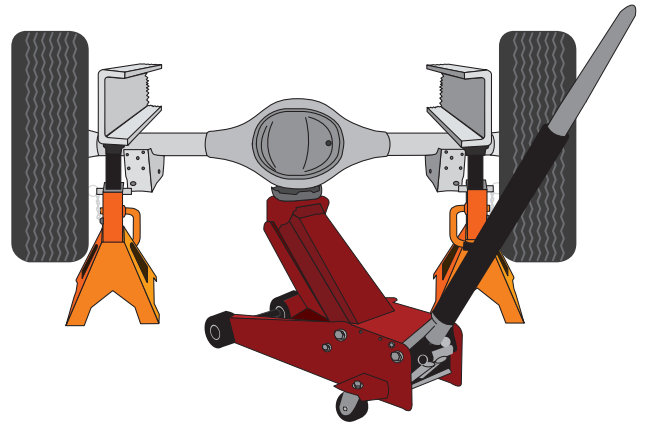

Fig. 2

2. Remove the factory jounce bumpers using a 13mm socket and an extension. The bolts have blue sealant on them and may require a small impact (Fig. 3).



Fig. 3

3. Thread the included M10 flange head bolt (Q) into the locations created by the jounce bumpers. Leave approximately a 1/2" (13mm) gap between the bolt flange and the chassis (Fig. 4).



Fig. 4

4. Install the upper brackets (C-left or D-right) by pushing the bracket up against the frame so the flanged bolt passes through the keyway in the bracket. When the bracket is against the frame push the bracket outward to lock into the keyway. Tighten the flanged nut (O), making sure the vertical portion of the bracket is touching the side of the frame (Fig. 5). Torque bolt to 20 lb.-ft. (27Nm).

Driver's (left) side

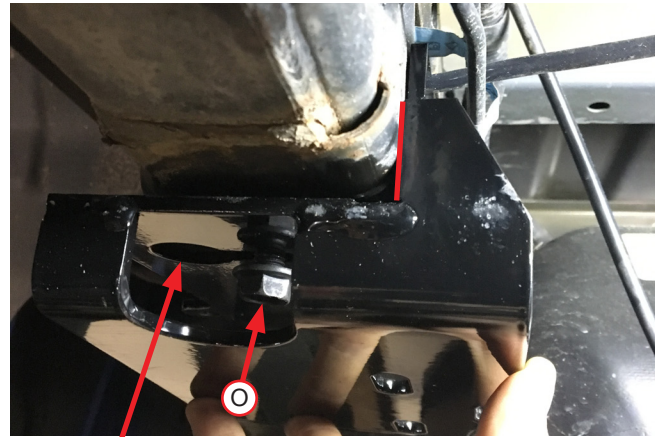

Keyway

Fig. 5

5. Remove the brake line tabs attached to both sides of the leaf spring perches with a 10mm socket (Fig. 6). Remove the plastic clip from the ABS line on the right side of the axle (Fig. 7).



Fig. 6

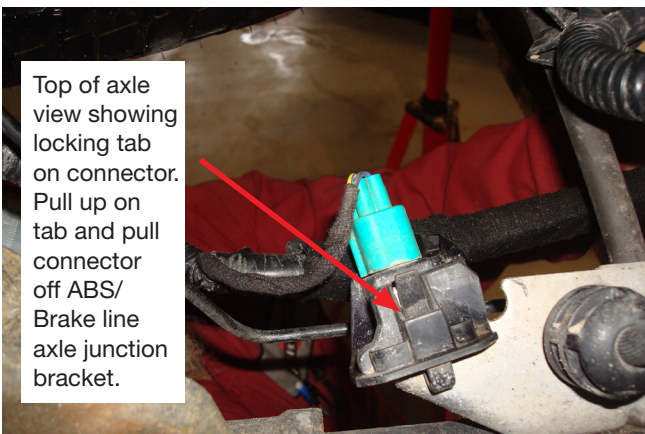

Fig. 7

### NOTE

*On all trucks, a small portion of the brake line bracket needs to be cut for proper clearance to fit the lower bracket.*

6. Pull up on the locking tab of the right-side connector and pull the connector off the ABS/Brake line axle junction bracket (Fig. 8). Pull the right side "cup" on the harness off the ABS/Brake axle junction bracket (Fig. 9). Pull the harness off the bracket and secure the harness out of the way for the next step.



Top of axle view showing locking tab on connector. Pull up on tab and pull connector off ABS/ Brake line axle junction bracket.

Fig. 8

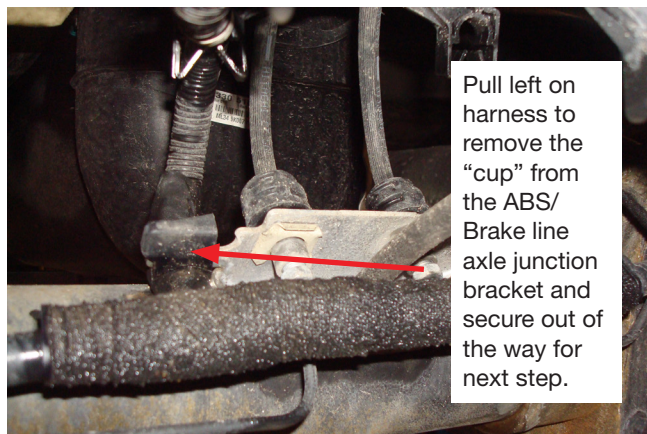

Pull left on harness to remove the "cup" from the ABS/ Brake line axle junction bracket and secure out of the way for next step.

Fig. 9



**⚠ CAUTION**

USE CAUTION WHILE CUTTING THE BRAKE LINE BRACKET. ENSURE THE BRAKE LINE AND WIRE HARNESS HAVE PROPER CLEARANCE TO AVOID DAMAGE FROM THE SAW.

7. Measure approximately 1.375" (35mm) from the edge of the bracket, this may vary depending on the truck. Use the dashed line on Fig. 10 as a reference. Make the cut to the bracket using a cutoff wheel, air reciprocating saw or a hacksaw.

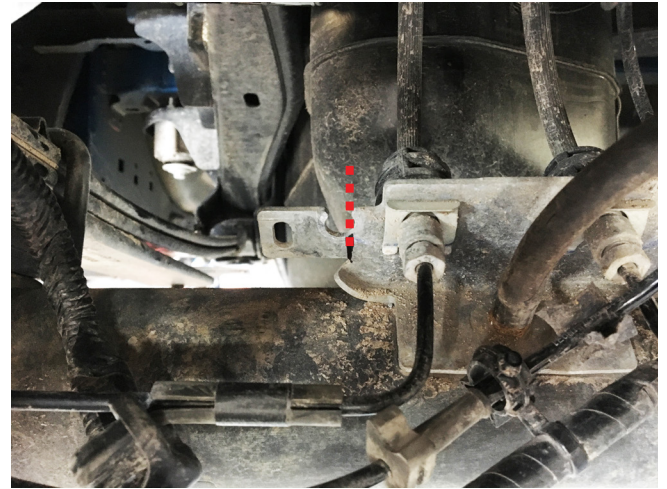
*Fig. 10*

8. Determine spacing between the upper and lower brackets by temporarily setting the lower bracket (B) into position and lower the body/frame of the truck so that it is sitting at ride height. Once the truck is at its natural ride height, measure the distance from the lower bracket to the upper bracket. Measure from the bottom mounting surface to the top mounting surface. If the measurement is 6.75" - 7.50" (171-191mm) the included spacer (G) will be required (Fig. 11).

*Fig. 11*

## NOTE

The following photos show installation with the spacer. If your truck does not require the spacer, use the included shorter hardware (N).

- Place a carriage bolt (M) through the front hole on the lower brackets (Fig. 12). Flip the air spring (E) upside down (air fitting port down). Place the roll plate (F) (Fig. 13), spacer (if required) (Fig. 14) and lower bracket (Fig. 15) on the air spring, making sure all the holes are lined up. Thread the hex-head screw (N or I) with flat washer (K) and lock washer (J) finger-tight. Keep everything loose enough so that the air spring can slide front to back. Ensure the air fitting port on the air spring is facing inboard of the vehicle and that the air spring is mounted forward on the bracket. See diagrams below for clarity (Fig. 16). Flip the assemblies upright and install the air fittings (H) finger tight plus 1 1/2 turns.



Fig. 12



If no spacer needed (roll plate only) use the included shorter hardware

Fig. 13



Spacer placement (if required)

Fig. 14

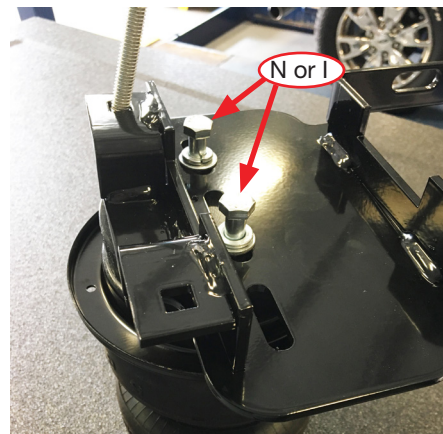

Lower bracket mounting hardware

Fig. 15

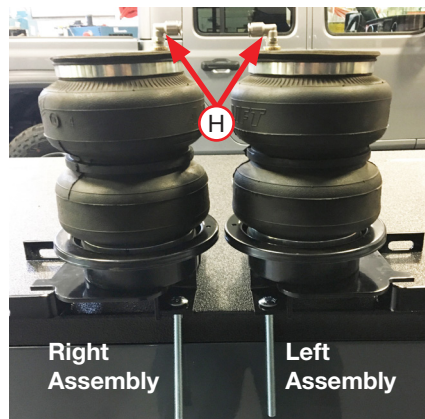

Note: Air springs are mounted forward on the bracket

Fig. 16



10. Lift the truck and let the axle hang. Place the assemblies on the axle (Fig. 17) with the tabs wrapping around the leaf spring perch (Fig. 18). Install the included self-threading screw (L) and brake line tab on the spring perch (Fig. 18). On the front side, use the self-threading bolt to secure the front tab to the spring perch (Fig. 19).



Fig. 17

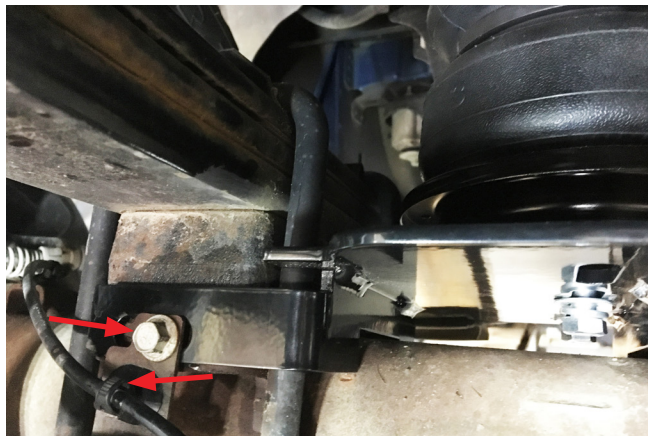

Fig. 18



Fig. 19

11. Install the remaining two carriage bolts onto the lower brackets (Fig. 20). Next, insert the clamp bars (A) over the carriage bolts with the serrated flange nuts (O) to attach the lower bracket assembly to the axle (Fig. 21). Torque to 16 lb.-ft. (22Nm).

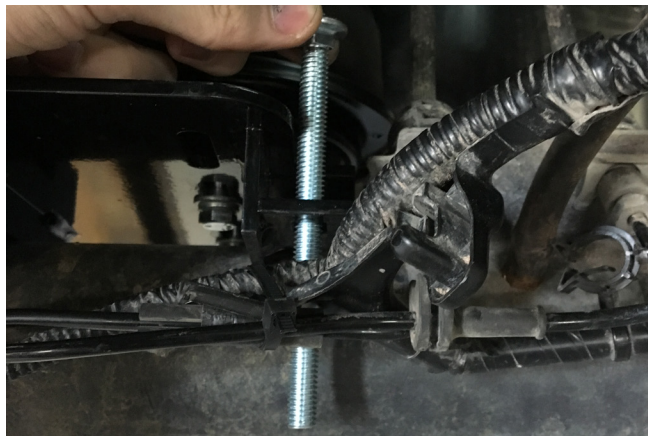

Fig. 20



Fig. 21

12. Place the last two roll plates on top of the air springs, making sure the mounting holes are lined up with the threaded holes on the air spring (Fig. 22). Raise the axle enough to allow the top of the air spring to move around a little. There should only be about a 1/8" (3mm) gap between the top of the air spring assembly and the upper bracket (Fig. 23).



Fig. 22



Fig. 23

13. Install the mounting hardware (I, J, K) to attach the air spring to the upper bracket. Thread the hardware finger-tight (Fig. 24).



Fig. 24

**⚠ CAUTION**

ENSURE PROPER CLEARANCE BETWEEN THE U-BOLT AND THE BRAKE LINES TO PREVENT DAMAGE TO THE BRAKE LINES.

14. Place the U-bolt (P) over the top of the frame and pass the ends through the two holes on the front side of the upper bracket. Thread serrated flange nuts on both sides and torque to 10 lb.-ft. (14Nm) (Fig. 25).

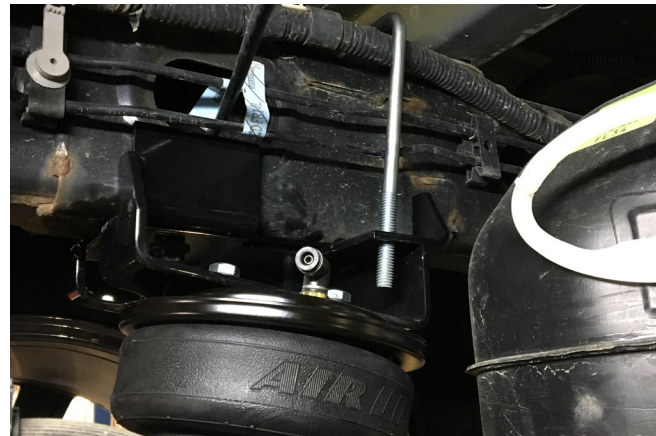

Fig. 25



15. Align the air spring by sliding the assembly forward or backward. Ensure clearance to objects around the air spring and torque the mounting hardware on the top and bottom to no more than 20 lb.-ft. (27Nm) (Fig. 26).

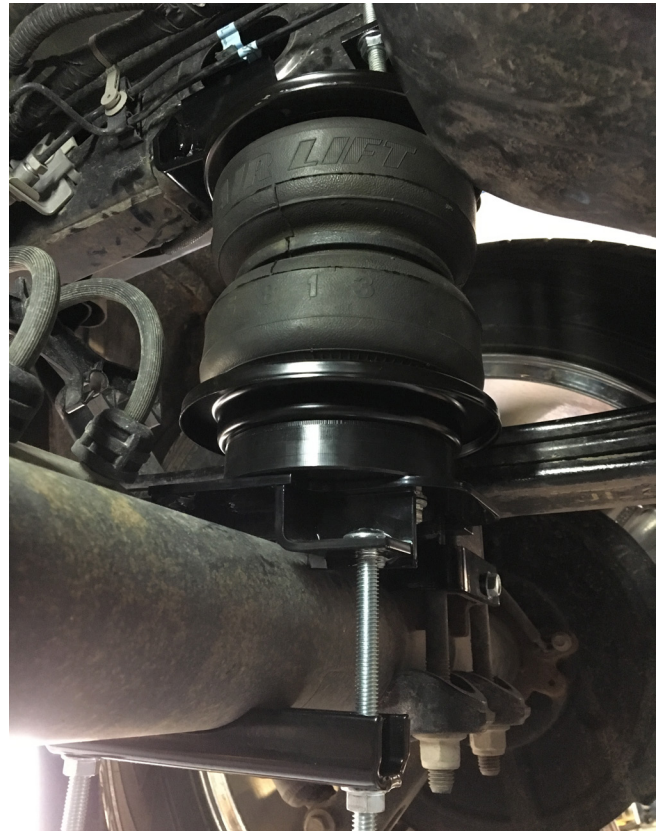

Fig. 26

**CAUTION**

ENSURE PROPER CLEARANCE AWAY FROM SHARP EDGES AND COMPONENTS TO PREVENT DAMAGE TO THE WIRING HARNESS AND ABS LINE.

16. Insert the left-hand ABS wiring harness bracket (R) into the “cup” of the ABS wiring harness and secure to the lower bracket (B) with 3/8"-16 X 7/8" hex-cap screw (U), 3/8" flat washer (K), and 3/8" nylon lock nut (Y) (Fig. 27 & Fig. 28). Tighten securely.

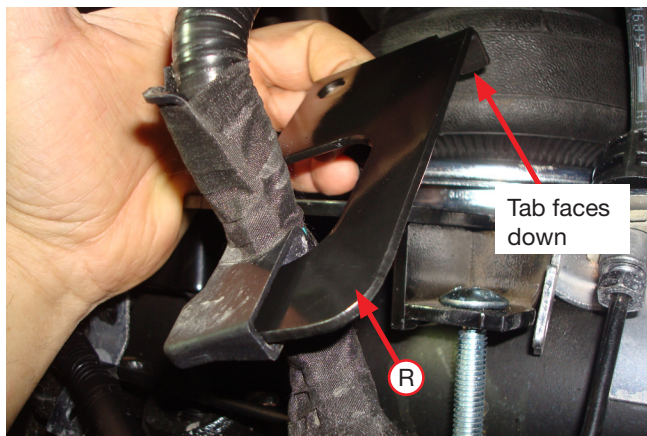

Fig. 27

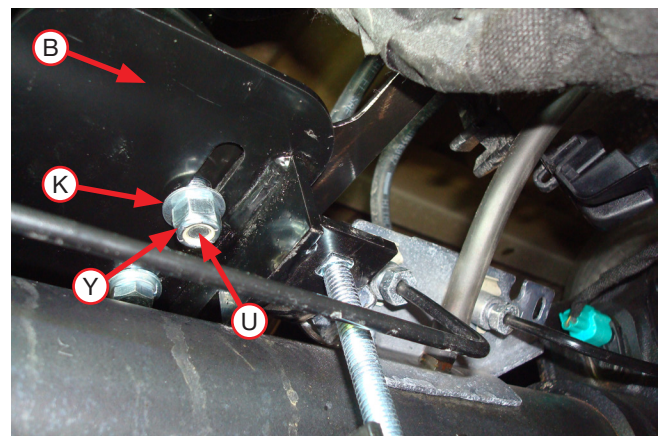
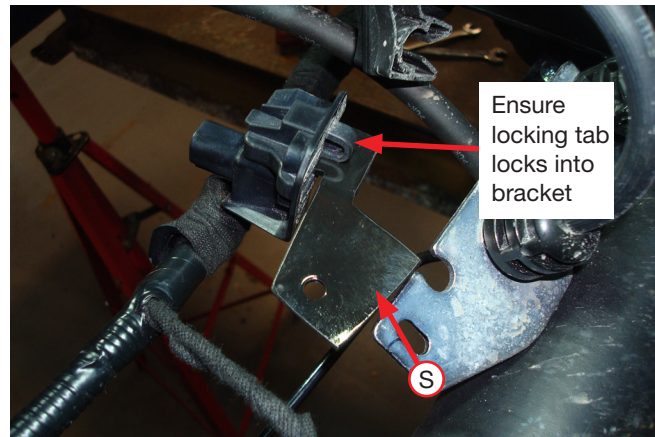
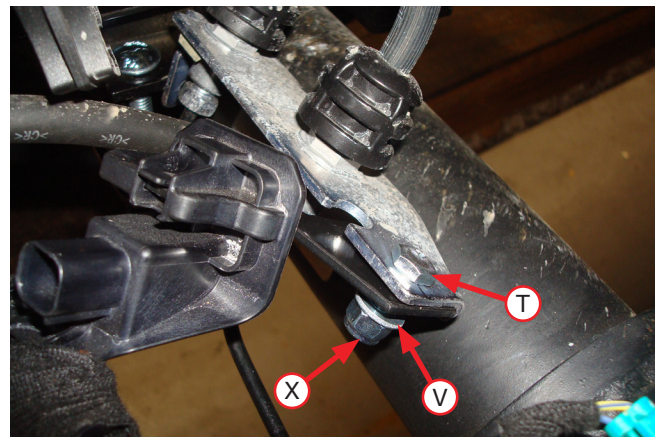

Fig. 28

17. Install the right-hand wiring harness connector onto the right-hand wiring harness bracket (S), making sure the locking tab locks the connector into position (Fig. 29). Secure to the ABS/Brake line axle junction bracket with 1/4"-20 X 3/4" hex-cap screw (T), 1/4" flat washer (V), and 1/4" nylon lock nut (X) (Fig. 30). Tighten securely.

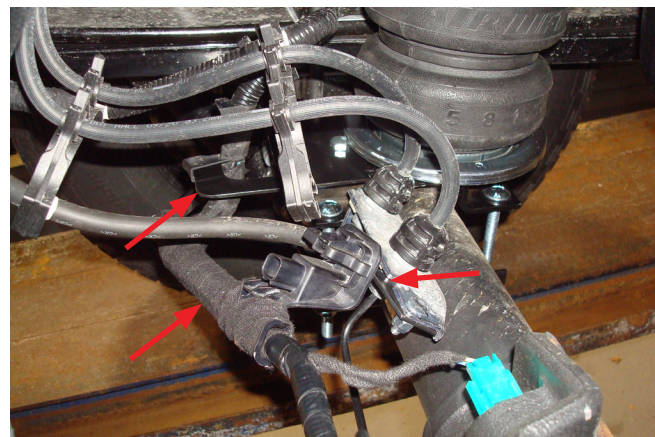

*Fig. 29*



*Fig. 30*

18. Fig. 31 shows a finished photo of how the ABS wiring harness is secured.



*Fig. 31*

# Installing the Air Lines

Air lines are routed from the air springs to Schrader valves. LoadLifter 5000 series air lines come in two styles: nylon and braided stainless steel. Begin by choosing locations for the Schrader valves and drill a 5/16" (8mm) hole, if necessary (Fig. 32).

**CAUTION**

KEEP AT LEAST 6" (150MM) OF CLEARANCE BETWEEN ALL AIR LINES AND THE EXHAUST SYSTEM. AVOID SHARP BENDS AND EDGES.

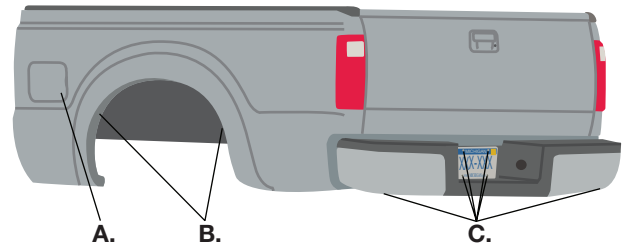

\* For LoadLifter 5000 Ultimate Plus kits, the recommended location for the Schrader valves is the rear bumper area or license plate.

- A. Inside fuel tank filler door
- B. Inside rear wheel wells
- C. License plate or rear bumper area\*

Fig. 32

## INSTALLING NYLON AIR LINES

1. For nylon air line, it is recommended that the air line be routed along the top of the frame, forward of the axle, then down to the fitting.
2. Cut the air line in half. Make clean, square cuts with a razor blade or hose cutter (Fig. 33). Do not use scissors or wire cutters.

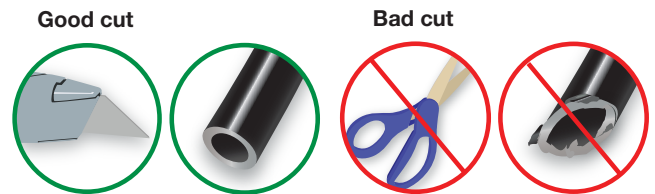

Fig. 33

3. Use zip ties (BB) to secure the air line to fixed points along the chassis. Do not pinch or kink the air line. The minimum bend radius for the air line is 1" (25mm). Leave at least 2" (50mm) of slack in the air line to allow for any movement that might pull on the air line.
4. Install the Schrader valve in the chosen location (Fig. 34).



## INSTALLING BRAIDED STAINLESS STEEL AIR LINES

### ⚠ CAUTION

KEEP THE AIR LINE AWAY FROM THE FUEL LINE, BRAKE LINES AND ELECTRICAL WIRES.

### NOTE

The braided stainless steel air line must be routed to the rear of the vehicle. Install the air line through one of the openings between the upper coil spring mount and the frame and then back to the rear where the schrader valves will be mounted (Fig. 34).

1. Use zip ties to secure the air line to fixed points along the chassis every 6" to 8" (150-200mm). Leave at least 2" (50mm) of slack to allow for any movement that might pull on the air line.
2. Tighten the air line hex nut finger-tight, then use 2 wrenches to turn 1 additional flat (1/6 of one full turn). Do not overtighten (Fig. 34 or Fig. 35). The easiest way to tighten the fitting is off the vehicle. Install the Schrader valve in the chosen location.
3. Coil and secure any excess air line in an area where it will not be susceptible to damage. The braided stainless steel air line cannot be trimmed.

### Air Line Setup Without Compressor System

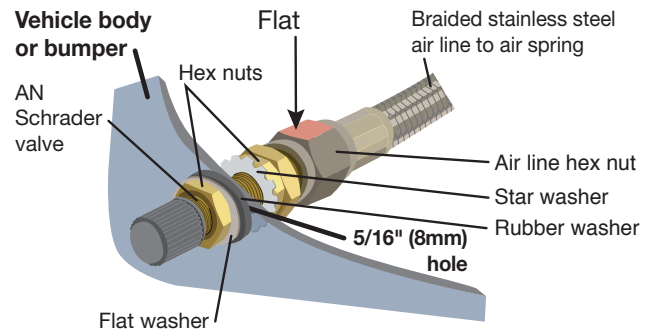

Fig. 34

### Air Line Setup for Compressor Integration

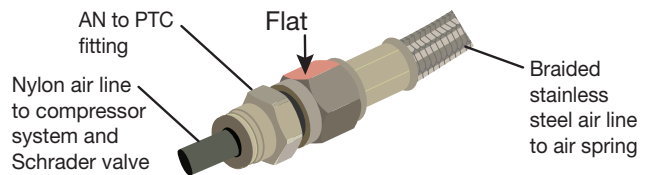

Fig. 35



## INSTALLATION CHECKLIST

- Clearance test** — Inflate the air springs to 40-60 PSI (2.8-4.1BAR) and make sure there is at least 1/2" (13mm) clearance from anything that might rub against each sleeve. Be sure to check the tire, brakes, frame, shock absorbers and brake cables.
- Leak test before road test** — Inflate the air springs to 40-60 PSI (2.8-4.1BAR) and check all connections for leaks. All leaks must be eliminated before the vehicle is road tested.
- Heat test** — Be sure there is sufficient clearance from heat sources, at least 6" (152mm) for air springs and air lines. If a heat shield was included in the kit, install it. If there is no heat shield, but one is required, call Air Lift customer service at (800) 248-0892.
- Fastener test** — After 500 miles, recheck all bolts for proper torque.
- Road test** — The vehicle should be road tested after the preceding tests. Inflate the springs to recommended driving pressures. Drive the vehicle 10 miles (16km) and recheck for clearance, loose fasteners and air leaks.
- Operating instructions** — If professionally installed, the installer should review the operating instructions with the owner. Be sure to provide the owner with all of the paperwork that came with the kit.

## MAINTENANCE AND USE GUIDELINES

1. Check air pressure weekly.
2. Always maintain normal ride height. Never inflate beyond 100 PSI (7BAR).
3. If the system develops an air leak, use a soapy water solution to check all air line connections and the inflation valve core before deflating and removing the air spring.

Minimum Recommended Pressure
<b>5 PSI (.34BAR)</b>

Maximum Air Pressure
<b>100 PSI (7BAR)</b>

**CAUTION**

FOR SAFETY AND TO PREVENT POSSIBLE DAMAGE TO THE VEHICLE, DO NOT EXCEED MAXIMUM GROSS VEHICLE WEIGHT RATING (GVWR) OR PAYLOAD RATING, AS INDICATED BY THE VEHICLE MANUFACTURER.

ALTHOUGH THE AIR SPRINGS ARE RATED AT A MAXIMUM INFLATION PRESSURE OF 100 PSI (7BAR), THE AIR PRESSURE ACTUALLY NEEDED IS DEPENDENT ON LOAD AND GROSS VEHICLE WEIGHT RATING.

## Limited Warranty and Return Policy

Air Lift Company provides a limited lifetime warranty to the original purchaser of its load support products, that the products will be free from defects in workmanship and materials when used on cars and trucks as specified by Air Lift Company and under normal operating conditions, subject to the requirements and exclusions set forth in the full Limited Warranty and Return Policy that is available at [www.airliftcompany.com/warranty](http://www.airliftcompany.com/warranty).

For additional warranty information contact Air Lift Company customer service.



# Notes





*Thank you for purchasing Air Lift Products — the Authorized Installer's choice!*

## Need Help?

Contact Air Lift Company Customer Service at (800) 248-0892  
or email [service@airliftcompany.com](mailto:service@airliftcompany.com).

For calls outside the U.S. or Canada, dial (517) 322-2144.



MADE IN USA  
WITH GLOBAL  
COMPONENTS

Air Lift Company • 2727 Snow Road • Lansing, MI 48917 or P.O. Box 80167 • Lansing, MI 48908-0167

Air Lift Company reserves the right to make changes and improvements to its products and publications at any time.  
For the latest version of this manual, contact Air Lift Company at (800) 248-0892 or visit [airliftcompany.com](http://airliftcompany.com).