



WirelessAIR™ EZ Mount™

Kit Number
74000EZ

EZ Mount Compressor System

Introduction

WirelessAIR™ EZ Mount™ combines a manifold and compressor into a single, easy-to-install unit, along with wiring harness and accessories needed to connect to vehicle power and air springs (purchased separately).

It is important to read and understand the entire installation guide before beginning installation or performing any maintenance, service or repair. The information here includes a hardware list, step-by-step installation information and safety information.

USING THE SYSTEM

Refer to the WirelessAIR User Guide included with this kit to learn how to operate the system.



NOTATION EXPLANATION

Hazard notations highlight information that must be observed to help minimize risk of personal injury or possible improper installation, which may render the vehicle unsafe.



INDICATES IMMEDIATE HAZARDS WHICH WILL RESULT IN SEVERE PERSONAL INJURY OR DEATH.



INDICATES HAZARDS OR UNSAFE PRACTICES WHICH COULD RESULT IN SEVERE PERSONAL INJURY OR DEATH.



INDICATES HAZARDS OR UNSAFE PRACTICES WHICH COULD RESULT IN DAMAGE TO THE MACHINE OR MINOR PERSONAL INJURY.

TOOLS LIST

Description.....	Qty
Power drill.....	1
3/8" Drill bits.....	1 ea.
3/8", 1/2", 5/16", 9/16" Sockets and ratchet	1 ea.
Wire stripping/crimping tool.....	1
Sharp razor knife	1

HARDWARE LIST

Item	Part #	Description.....	Qty
A	73006	Wireless controller	1
B	26564	EZ Mount assembly	1
C	20946	Air line (1/4")25 ft.
D	26897	Wiring harness	1
Hardware Pack			
E	21838	Tee 1/4" PTC	2
F	24652	ATC fuse, spade 15A	1
G	24752	Heat shrink butt splice 10-12 ga	2
H	24500	Fuse holder ATC/ATO	1
I	10466	8" Zip tie	18
J	24748	3/8" Ring terminal 10-12 ga.....	1
K	11104	U-bolt.....	1
L	18435	3/8"-16 Nylon lock nut.....	2
M	18444	3/8" Flat washer.....	4
N	17188	3/8"-16 x 1 1/4" Hex cap bolt.....	2
O	17102	5/16"-18 x 3/4" Self-tapping hex screw	2
P	10868	Tree mount.....	3
Q	24661	Heat shrinkable butt splice 14-16 ga.....	1
R	24681	3/8" Ring terminal 14-16 ga.....	1

SUGGESTED COMPONENT LAYOUT

This guide should be used as a general reference (Fig. 2). The layout may need modification based on the application.

- Ideally, EZ Mount should be mounted in the middle of the vehicle in the zone marked by the yellow square to optimize the wireless performance.
- Avoid routing air lines and wiring near sharp edges. If passing air lines or wiring through holes in the frame, use rubber grommets. Support wiring and air lines every 8-12" (200-300mm) with zip ties or other means.
- Keep wiring, air lines and EZ Mount at least 6" away from heat sources such as the exhaust.

CAUTION

DO NOT MOUNT EZ MOUNT WITH THE LOGO UPSIDE DOWN OR THE LOGO FACING THE GROUND (FIG. 1).

DO NOT HANG EZ MOUNT FROM A HORIZONTAL SURFACE USING SELF-TAPPING SCREWS.

PLACE THE COMPONENTS AND ROUTE THE AIR LINES AND WIRING HARNESS TO AVOID HEAT SOURCES SUCH AS THE EXHAUST SYSTEM.

PROTECT AIR LINES AND WIRING WHEN ROUTING NEAR SHARP EDGES.

LOCATE EZ MOUNT IN AN AREA OF THE VEHICLE WHERE IT WILL BE SHIELDED FROM DIRECT SPLASH. EXCESSIVE MOISTURE CAN DAMAGE THE COMPRESSOR AND CAUSE SYSTEM FAILURE.

REMOVE ALL FUSES WHEN JUMP-STARTING OR WELDING ON THE VEHICLE. FAILURE TO DO SO COULD DAMAGE THE MANIFOLD.

TO KEEP VOLTAGE DROP WITHIN INDUSTRY STANDARDS, DO NOT EXTEND WIRES. EXTENDING THE WIRES COULD DECREASE COMPRESSOR LIFE.

Wiring to the battery

CAUTION
INSTALL THE FUSE AFTER ALL CONNECTIONS ARE MADE.

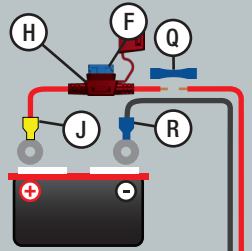

OPTIONAL Ignition Source Connection

Connect the pink wire to any wire that is active when the ignition is on. This will allow WirelessAIR to only make adjustments when the ignition is turned on. Otherwise, the system will only activate when the vehicle moves or when woken up by the controller or mobile app. Hardware to connect to the ignition is not included. This is a low-amperage circuit that should be connected to the output side of a 10A or smaller fuse-protected circuit.

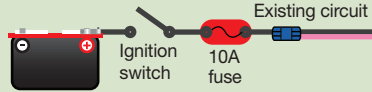

CAUTION

INSTALL COMPRESSOR INLET FILTER IN A DRY LOCATION. ENSURE THAT THE FILTER IS MOUNTED POINTED UP WITH THE HOSE ROUTED DOWN.

To keep voltage drop within industry standards, do not extend wires. Extending the wires could decrease compressor life.

The frame width for using the U-bolt must be 2 1/4"-3 3/4" (57-95mm). Frame height must be 7 1/2"-8 1/2" (191-216mm).

EZ Mount (Manifold & Compressor)

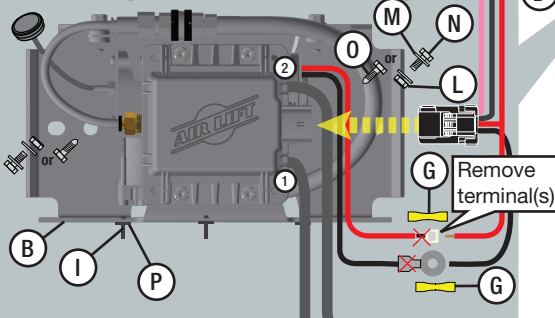

Hex cap bolt torque
21-25 lb.-ft. (30-34Nm)

U-bolt torque
4-6 lb.-ft. (5.4-8.1Nm)

Self-tapping screw torque
No torque spec is provided for self-tapping screws because there are too many variables.

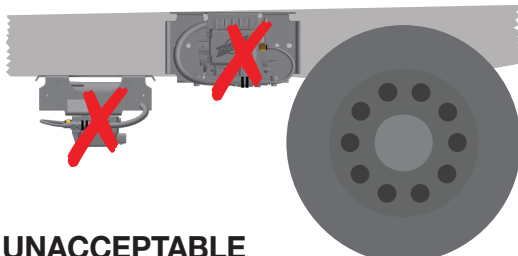
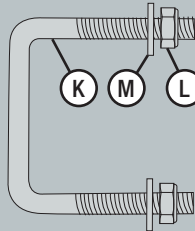

UNACCEPTABLE MOUNTING ORIENTATIONS

fig. 1

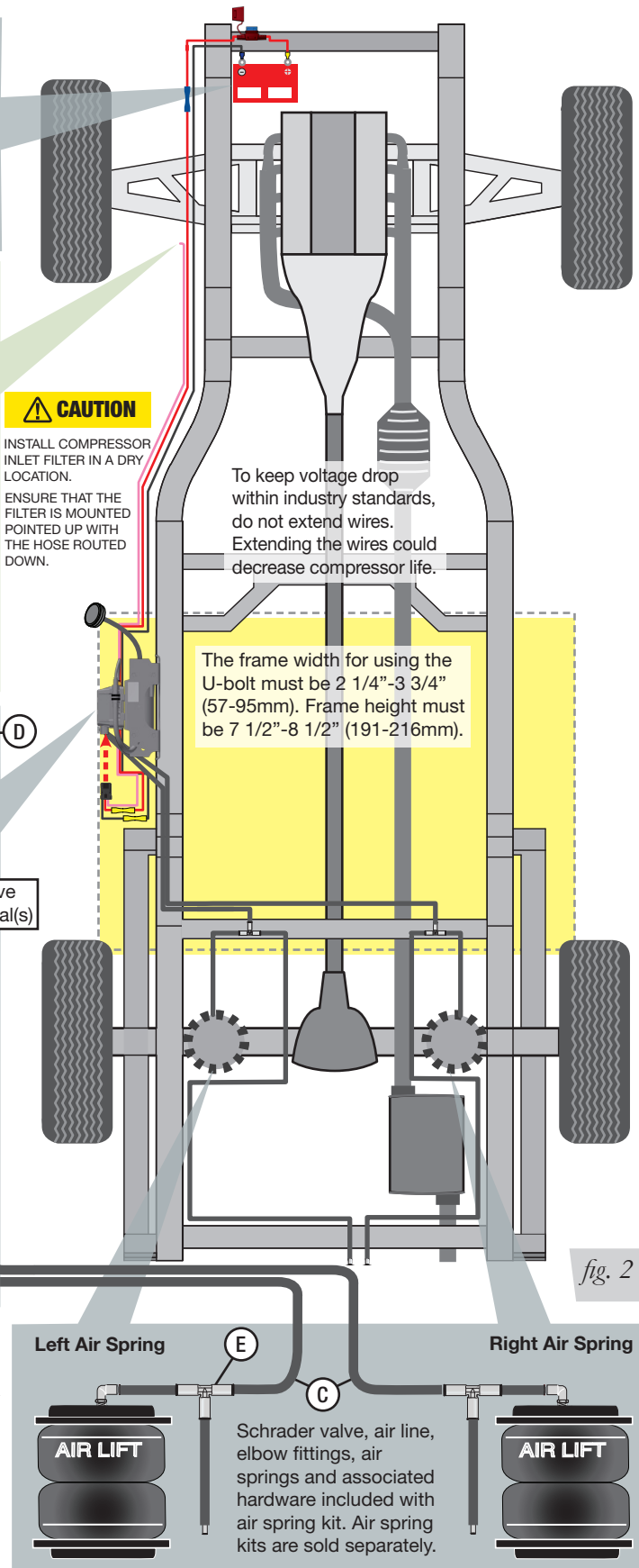

fig. 2

Installing WirelessAir EZ Mount

1. There are three choices for mounting:
 - Hex cap bolts (N) with flat washers (M) and nylon lock nuts (L).
 - U-bolt (K) with washers (M) and nylon lock nuts (L). See Figure 3 for U-bolt installation.
 - Self-tapping screws (O).
2. EZ Mount can be mounted in any orientation except with the logo upside down or the logo facing the ground (Fig. 1). There are mounting holes in the side of the bracket and in the top. Use the included template (Fig. 4) for mounting with self-tapping screws or hex cap bolts. Use a 1/4" drill bit to make pilot holes if using self-tapping screws.



U-bolt installation

fig. 3

⚠ CAUTION

BEFORE DRILLING, ENSURE THAT THE BACK SIDE IS CLEAR OF VEHICLE COMPONENTS, INCLUDING BRAKE LINES, FUEL LINES, AND WIRING.

3. Do not remove components from the EZ Mount assembly.

REMOTE FILTER INSTALLATION

1. Screw 1/4" FNPT x 1/4" barbed tube fitting onto inlet air filter, hand-tighten. No thread sealant needed.
2. Attach 1/4" air line, provided in the filter pack, to barbed tube fitting on remote inlet air filter.
3. Locate appropriate area where remote inlet filter is to be installed. Keep in mind that location should be dry and away from heat source, and that the air inlet slots on the inlet air filter are free from blockage.
4. Secure remote filter appropriately using proper fastening methods or drill a 3/8" mounting hole and push remote filter bracket pin into the mounting hole.
5. Route air line to inlet port of the compressor. Measure and cut squarely to appropriate length (Fig. 6). Make sure when routing you keep away from sharp edges and you allow for proper bend radius to avoid kinking.
6. Attach cut end of 1/4" air line to barbed tube fitting of air inlet port on compressor.

DRILLING TEMPLATE VERIFICATION

⚠ CAUTION

IMPORTANT: PRINT THIS PAGE AT 100% SCALE. THIS IS A DRILLING TEMPLATE, WHICH WOULD BE RENDERED INCORRECT IN DIMENSION IF PRINTED WITH ANY SCALING. USING AN INCORRECT TEMPLATE TO DRILL HOLES MAY CAUSE DAMAGE TO THE VEHICLE! PLEASE REFER TO THE ONE-INCH OR 1CM SCALES AND USE A MEASURING TOOL TO CONFIRM THAT THE PRINTED SCALE MEASURES 1" OR 1CM TO VERIFY THAT THE TEMPLATE HAS BEEN PRINTED AT 100% SCALE.

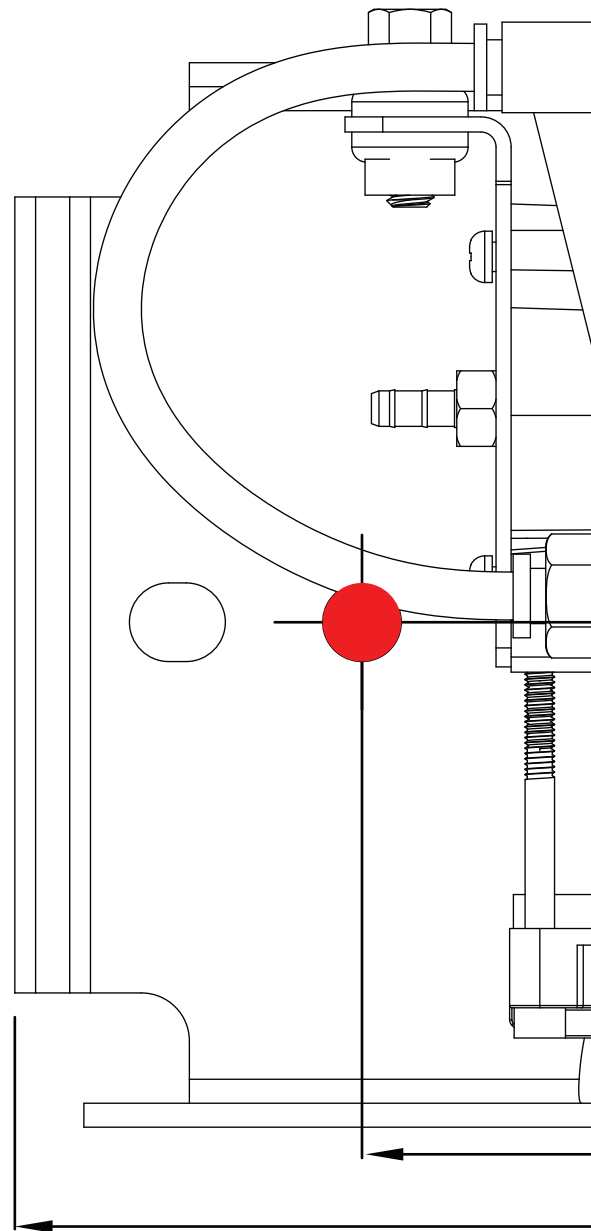
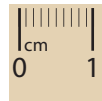

SIDE

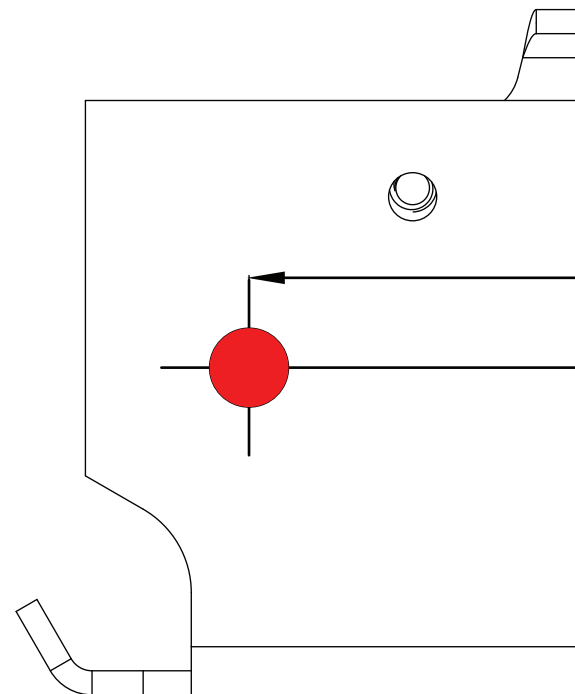

TOP

fig. 4

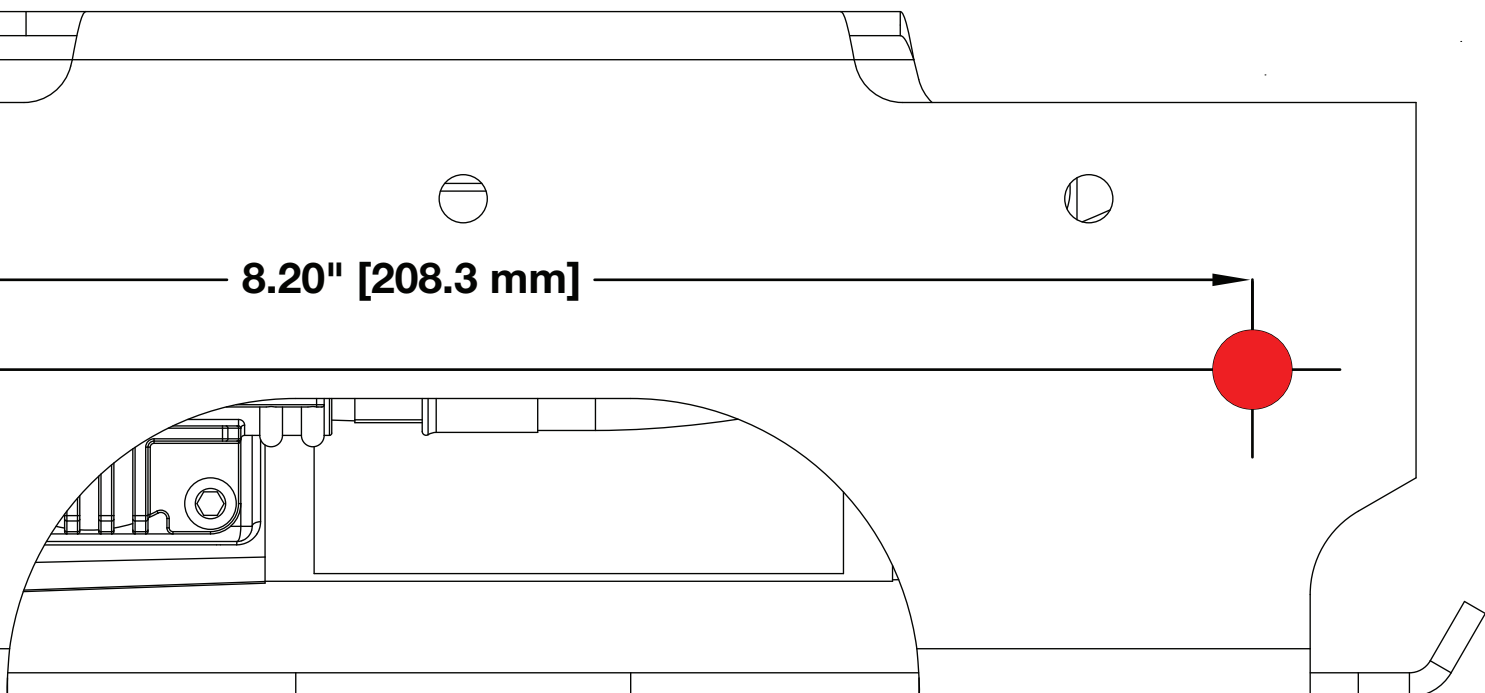
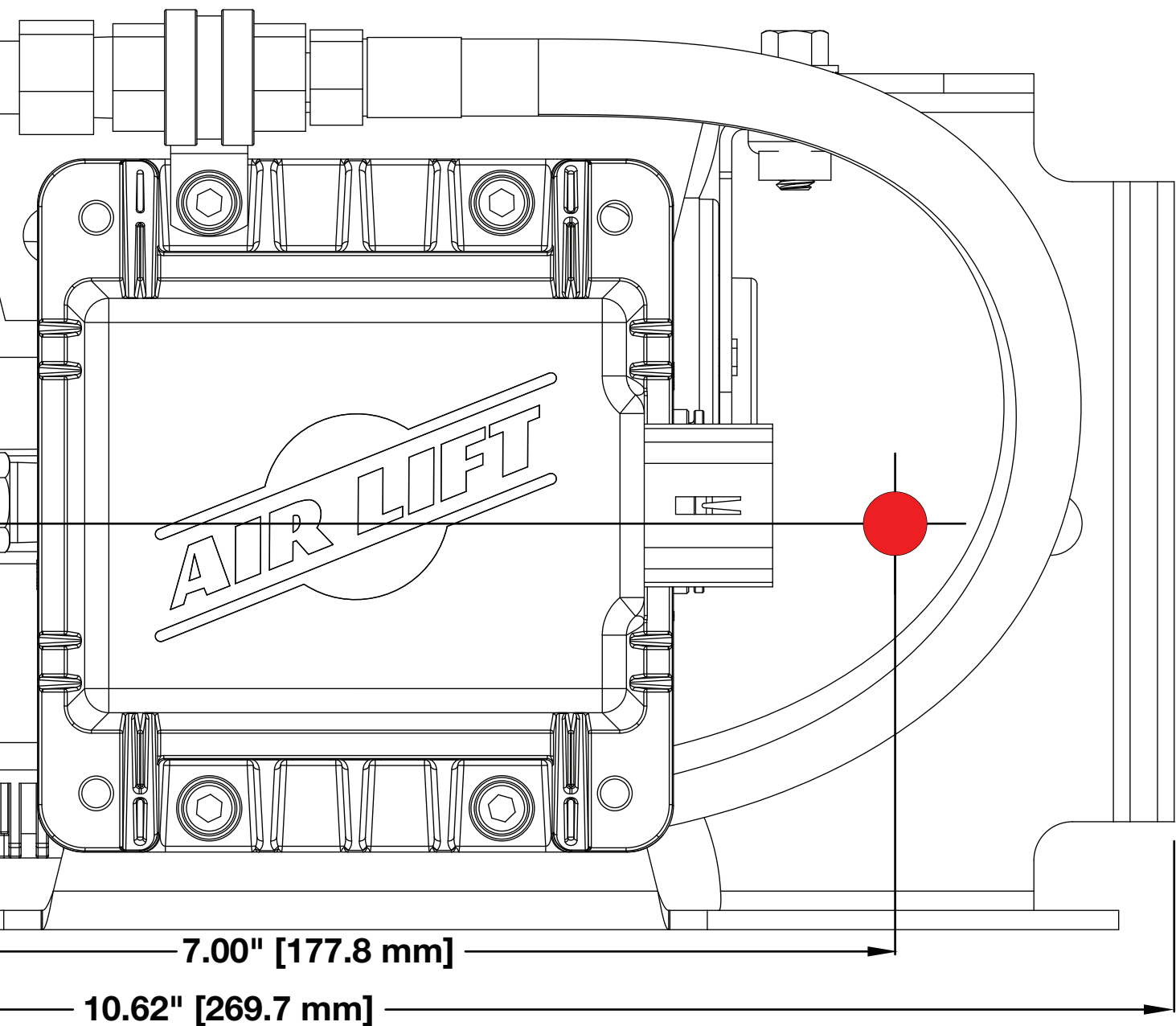

AIR LINE AND WIRING CONNECTIONS

1. Route and install an air line (C) from port 1 of the manifold to the driver's (left) side air spring. Route and install an air line (C) from port 2 of the manifold to the passenger's (right) side air spring (Fig. 2). Install tee fittings (E) and schrader valves if manual inflation is desired (Fig. 2). To ensure a proper and clean cut, see *Cutting the Air Lines*.
2. Route the wiring harness (D) along the frame and make all wiring connections (Fig. 2).
3. Cut off the terminals on the red and black compressor wires and connect to the short red and black wires on the wiring harness (D) using butt splices (G) (Fig. 2). The ground wire cannot be grounded to the chassis and must be connected to the harness. Finish by connecting the wiring to the battery. Wait to install the fuse.
4. Attach the wiring harness to the top (preferred) or bottom of the EZ Mount bracket with tree mounts (P) and zip ties (I) (Fig. 5).

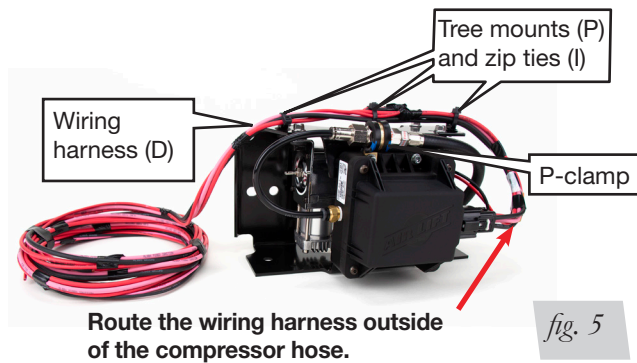

5. Connect the wiring harness (D) to the manifold (Fig. 2). Press the connector on completely and listen for an audible “click.” Press white lock on connector toward manifold to lock connector in place. Ensure a proper drip loop exists to prevent water intrusion (Fig. 6). Install the fuse (F) last. The system will automatically fill to 5 PSI (.34BAR) once the fuse is installed.

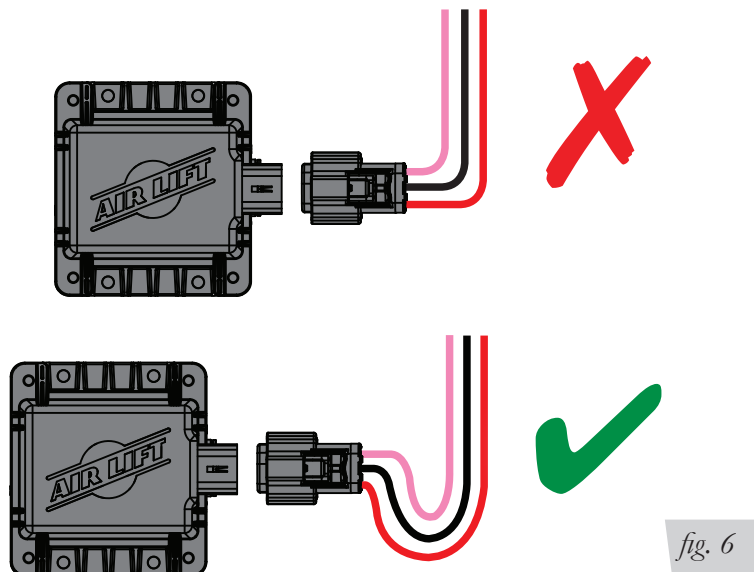

CUTTING THE AIR LINES

Use a sharp knife or a hose cutter and make clean, square cuts (Fig. 7). Do not use scissors or wire cutters because these tools will deform the air line. Do not cut the lines at an angle. The minimum bend radius for 1/4" air line is 1" (25mm). Air lines are to be installed straight into fittings. Inspect the air line for scratches that run lengthwise. Contact Air Lift customer service if the air line is damaged.

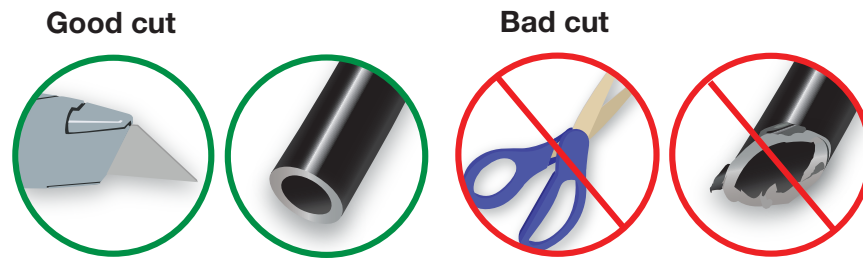

fig. 7



To watch a video demonstrating proper air line cutting, go to air-lift.co/cuttingairline.

Need Help?

Contact Air Lift Company customer service department by calling (800) 248-0892.

For calls from outside the USA or Canada, dial (517) 322-2144.



Thank you for purchasing Air Lift products – the professional installer's choice!

Air Lift Company reserves the right to make changes and improvements to its products and publications at any time. For the latest version of this manual, contact Air Lift Company at **(800) 248-0892** or visit www.airliftcompany.com.

Air Lift Company • 2727 Snow Road • Lansing, MI 48917 or P.O. Box 80167 • Lansing, MI 48908-0167
Toll Free (800) 248-0892 • Local (517) 322-2144 • Fax (517) 322-0240 • www.airliftcompany.com

Printed in the USA
JJC-1119

California: ⚠️WARNING: Cancer and Reproductive Harm - www.P65Warnings.ca.gov



Wireless**AIR**[™]



User Guide

IDENTIFYING THE DIFFERENCES BETWEEN KITS

Should you need to contact Air Lift customer service, you will need to know which kit you are inquiring about: The first-generation WirelessAir or the second-generation. The kits are easily identifiable by looking at the wireless controller or the manifold, which is likely mounted under the vehicle.

FIRST GENERATION



Manifold



Wireless controller

SECOND GENERATION



Manifold



Wireless controller

Table of Contents

A. Introduction	4	F. Android App Configuration	16
Notation Explanation	4	Navigation/Communicate	16
System Functionality	5	App Presets	17
B. Wireless Controller	7	Firmware Updates	17
Operation	7	G. Troubleshooting Guide	18
Backlight	7	Replacing Battery in the Wireless Controller	22
External Power	7	FCC and Industry Canada Information to User	22
Pair the Manifold to the Wireless Controller	8	Finding Air Leaks	23
Units	8	Fixing Leaks on Barbed Fittings	23
Troubleshooting	8	Cutting Air Lines	24
Wireless Controller Menu	9	Fixing Leaks on PTC Fittings	24
Wireless Controller Presets	9	Limited Warranty and Return Policy	25
C. Mobile App User Interface	10	Replacement Part Information	26
D. Pair the Manifold to the Mobile App	12	Contact Information	26
E. iOS App Configuration	14		
Navigation	14		
App Presets	15		
Firmware Updates	15		

NOTE *WirelessAir is shipped with a default maximum pressure of 35 PSI (2.4BAR). See “Wireless Controller Menu” to change air bag type (if needed).*

A. Introduction

WirelessAir™ is an on-board air compressor system designed to easily level the vehicle digitally. It can be operated both with the included wireless controller and with a free app, available for iOS and Android operating systems.

The kit includes a compressor, manifold, wiring harness, wireless digital controller, air line and integrating hardware. The system can be used inside or outside the vehicle, for adjustments in full view of the vehicle.

WirelessAir is a dual path system. The wireless digital controller is a battery-powered unit. Three user-defined memory settings are provided for frequently used settings. As an added safety measure, WirelessAir maintains minimum air pressure (5 PSI [.34BAR]) in the system. The manifold is also weather resistant for maximum life expectancy.

NOTATION EXPLANATION

Hazard notations appear in various locations in this publication. Information which is highlighted by one of these notations must be observed to help minimize risk of personal injury or possible improper installation, which may render the vehicle unsafe. Notes are used to help emphasize areas of procedural importance and provide helpful suggestions. The following definitions explain the use of these notations as they appear throughout this guide.



INDICATES IMMEDIATE HAZARDS WHICH WILL RESULT IN SEVERE PERSONAL INJURY OR DEATH.



INDICATES HAZARDS OR UNSAFE PRACTICES WHICH COULD RESULT IN SEVERE PERSONAL INJURY OR DEATH.



INDICATES HAZARDS OR UNSAFE PRACTICES WHICH COULD RESULT IN DAMAGE TO THE MACHINE OR MINOR PERSONAL INJURY.

SYSTEM FUNCTIONALITY

- Maintain mode is intended to ensure that air spring pressure does not drop below the target pressure value. Therefore, the system will only inflate to maintain a pressure but it will never deflate when a load is added. Preset values should be set after the vehicle is loaded (except for Air Lift 1000 Series).
- The wireless controller primarily displays the target pressure. The actual pressure is only shown when the system is making an adjustment. Keep in mind that if you set a target pressure and then add or remove load, the actual pressure will likely change. Preset values should be commanded after the vehicle is loaded or unloaded (except for Air Lift 1000 Series).
- When the system performs an inflate, the exhaust valve will temporarily open to relieve compressor head pressure. An audible exhaust sound will be heard during an inflate.
- During an inflate, the compressor will slowly start up to build pressure. This slow start is noticeable and is expected behavior. It does not indicate a bad compressor.
- The system limits the maximum pressure to the air spring depending on the air spring kit installed. The default is 35 PSI (2.4BAR) so if using an air spring kit other than Air Lift 1000, you will need to change the air bag type.
- The system uses Bluetooth technology and can only hold a connection with one wireless controller or mobile device at a time. If the wireless controller is connected, you can not connect to the mobile app until the connection is closed. The wireless controller will also stay connected for 30 seconds after the screen goes off. After that time, the mobile app can be connected. Similarly, the mobile app needs to be closed in order to connect with the wireless controller.
- To avoid constant adjustments, the system will target within 2 PSI (.14BAR) of the target pressure. Therefore, there may be instances where a single increment or decrement of the target pressure does not force an adjustment.
- When power is cycled to the manifold, it will target the last stored target pressure. An audible adjustment may be heard. Cycling power includes removing and reinstalling the fuse, disconnecting and reconnecting the manifold connector or performing a firmware update which results in a restart.

SYSTEM FUNCTIONALITY (CONT.)

- Whenever you have a new device to pair to the manifold, the power to the manifold will need to be cycled. Cycling power includes removing and reinstalling the fuse or disconnecting and reconnecting the manifold connector.
- The compressor duty cycle limits the compressor's on time in order to protect the compressor and ensure longevity. When a compressor over-run fault is set, the system will not inflate and a wait period is needed until the compressor will operate again.
- The system has advanced fault detection in order to prevent system damage and ensure system longevity. Some faults do require a manifold power cycle to clear. This is to ensure that the cause is evaluated and resolved before causing any potential damage. Please refer to *G. Troubleshooting Guide* for instructions on resetting faults.
- Use of the ignition wire is optional. If it is connected to a switched ignition source, the system will only turn on while ignition is on and will remain off while ignition is off. If the ignition wire it is not used, the system will use a wake-on-motion algorithm to turn on the system when vehicle motion is detected. The system will then turn off after a period of no vehicle motion. The system will enter ignition mode after the first ignition cycle is completed. The system can be removed from ignition mode by cycling battery power to the manifold (fuse cycle).

B. Wireless Controller

OPERATION

1. Push any button to wake up the wireless controller, which will show the desired pressure.
2. Press the up or down arrows to raise or lower the pressure in increments of 1 PSI or 0.1BAR.
3. Maximum pressure depends on the air spring used.
4. The default maximum pressure is 35 PSI (2.4BAR).

Maximum Pressure	↑	100 PSI (7BAR)
Minimum Pressure	↓	5 PSI (.34BAR)

*Maximum pressure varies based on the kit you purchased (see chart on page 9).

BACKLIGHT

The wireless controller display stays on for 30 seconds. The backlight automatically dims after 10 seconds, then goes off after an additional 30 seconds. The wireless controller will stay connected for 1 minute after display goes dark. Press any button to wake up the wireless controller.

EXTERNAL POWER

The wireless controller can be powered by an external 5V supply using the micro USB connection. The display will remain on for 4 hours while connected to external power. This is not a recharge port. It is only used for direct power.

Connection Status/

Signal Strength

Target Pressure

Current Pressure

Current Preset

Preset 1, 2, 3

Set a preset by attaining desired pressure then holding the preset button for 5 seconds

Up & Down Arrows

Increase or decrease pressure using these arrows.



5V Micro USB Power

Inflate/Deflate Arrow

System Faults (not shown)

Home/Enter

Wake up display by tapping on it. When adjusting pressure, press button to attain pressure. To enter the menu, hold button for 3 seconds.

Left & Right Arrows

Select a side to adjust pressure. The arrow on the screen shows which side is currently being adjusted (Left, Right, or Both).

fig. B.1

NOTE To enter the menu, press and hold the center button for 3 seconds (Fig. B.1).

PAIR THE MANIFOLD TO THE WIRELESS CONTROLLER

The manifold will enter pairing mode for five minutes after the fuse is installed.

Once a device is paired, it will automatically connect if no other device is already connected. The wireless controller will dim after 10 seconds and will go off after 30 seconds. After 1 minute, the wireless controller will turn off, at which time it will disconnect from the system.

NOTE *The wireless controller comes without the battery installed. Install the battery prior to operation.*

1. To initiate pairing mode, remove the main system fuse, wait five seconds and reinstall.
2. Press any button to wake up the wireless controller. It will automatically go to the pairing screen if it is not already paired with a manifold. Use the up and down arrow buttons to navigate the pairing menu. Select the device that matches the manifold serial number located on the side of the manifold (Figs. B.2 & B.3).
3. The device will indicate “connecting” when it is connecting to a device.
4. Once complete, the wireless controller will either indicate “Pairing successful,” which means the devices are paired, or “Pairing unsuccessful,” which will require the user to pull and reinstall the fuse and try again (Return to Step 1). Once the wireless controller is connected to the manifold, it will automatically connect each time the manifold is active and the controller is woken up.

NOTE *To enter the menu, press and hold the center button for 3 seconds (Fig. B.1).*

UNITS

Choose Units from settings option in the menu screen to change between PSI and BAR (Fig. B.4). The factory default is PSI.

TROUBLESHOOTING

Choose Troubleshooting from the menu to see system error messages. For more information about error messages, see *G. Troubleshooting Guide*.



fig. B.2



fig. B.3



fig. B.4

WIRELESS CONTROLLER MENU

BRIGHTNESS

1. Use the up and down arrows to set desired brightness.
2. Press the center button or Preset 3 button to save the setting.

AIR BAG TYPE

1. Use the up and down arrows to set the air bag type.
2. Selecting the correct air bag type will limit the maximum operating pressure. Refer to the table below for allowable maximum pressures. The default air bag type is Air Lift 1000 with a maximum pressure of 35 PSI (2.4BAR).

COMPRESSOR DUTY CYCLE

1. Use the up and down arrows to set the desired compressor duty cycle.
2. Press the center button or Preset 3 button to save the setting.
3. Select tank setting when using an external solenoid and tank instead of a compressor.

NOTE *Compressor duty cycle should not be set higher than the compressor specifies.*

Air Spring System	Minimum Pressure		Maximum Pressure	
	PSI	BAR	PSI	BAR
Air Lift 1000™	5	.34	35	2.4
Air Lift 1000HD™	5	.34	50	3.4
RideControl™	5	.34	100	7
LoadLifter 5000™ Series	5	.34	100	7

WIRELESS CONTROLLER PRESETS

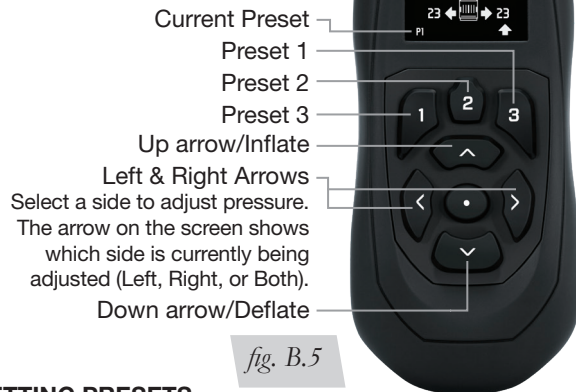

SETTING PRESETS

1. Set the pressure to the desired level using the up and down arrows (Fig. B.5).
2. To set each preset:
 - Preset 1:** Press and hold Preset 1 button for 5 seconds
 - Preset 2:** Press and hold Preset 2 button for 5 seconds
 - Preset 3:** Press and hold Preset 3 button for 5 seconds
3. For example, after setting the desired pressures, press and hold the upper left button to set Preset 1. Preset 1 saved will be displayed at the bottom of the screen.
4. The wireless controller will indicate which preset is currently selected in the lower left corner.

C. Mobile App User Interface

1. When the app is open to the user interface, it shows the desired pressure (Fig. C.1 or C.2).
2. Press the up or down arrows to inflate or deflate in increments of 1 PSI (0.1BAR).
3. To select a preset, press anywhere inside the row containing the desired preset name. To obtain the preset, press inside the row a second time.

NOTE *Maximum pressure will depend on the type of air spring selected. The default is Air Lift 1000(35 PSI [2.4BAR]).*

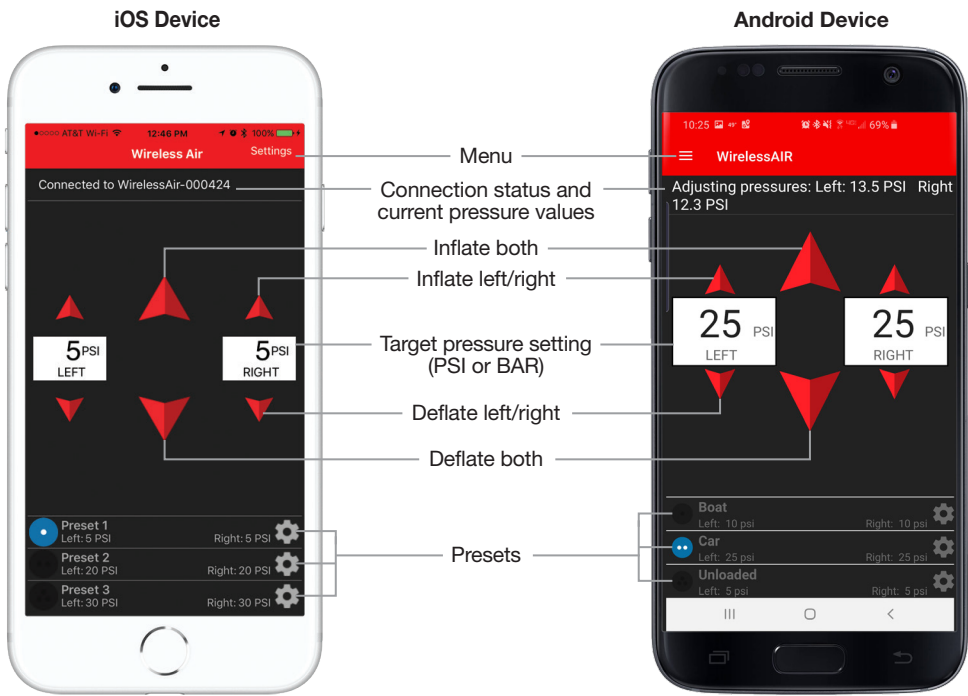

fig. C.1

fig. C.2

D. Pair the Manifold to the Mobile App

1. Download the free Air Lift WirelessAir app from the Apple App Store for iOS and from Google Play for Android. Search for Air Lift WirelessAir.
2. You can put the manifold into pairing mode using the display. Go into the display menu, Pairing, then Pair with App. The display will say “Pairing Enabled.” Then use the App to pair with the manifold. You can also put the manifold in pairing mode by removing the fuse and reinstalling it after five seconds. The manifold will remain in pairing mode for five minutes after the fuse is reinserted.
3. The app will automatically go to the devices screen if no connected manifold is detected. Click on the device you want to pair. The manifold will have WirelessAir in the title, along with the serial number. Each device also shows the connection status (Fig. D.1 or D.2).
4. Once the mobile app is paired to the manifold via Bluetooth, it will connect automatically each time the manifold is active and the device is in range. Only one device can be connected at a time. To connect another device, the app on any device currently connected must be closed.
5. To pair a second mobile device, repeat the procedure on that device. The manifold can pair with up to 4 devices. If a 5th device is paired the first device will be removed. There is no limit to the number of manifolds one mobile device can pair with.



iOS Device

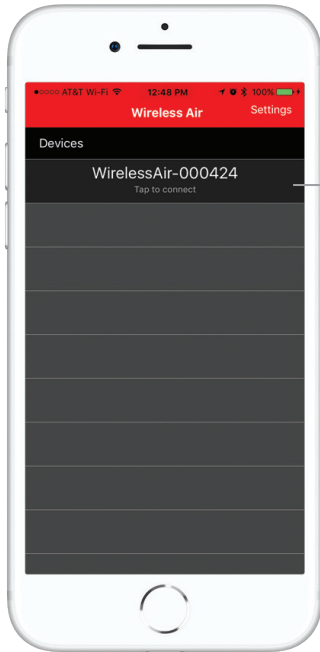

fig. D.1

Android Device

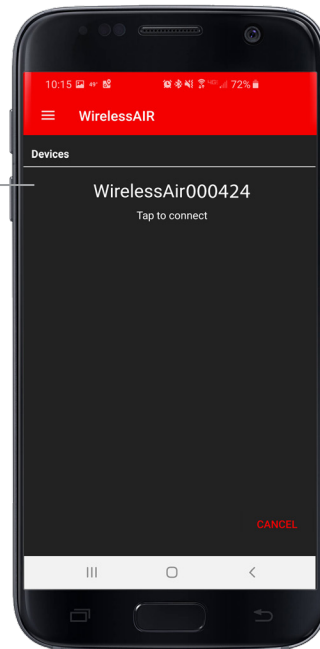

fig. D.2

Manifold title

E. iOS App Configuration

NAVIGATION

1. The Navigation screen (Fig. E.1) has these options:

Devices

- Lists manifolds that are within range

Troubleshoot

- Displays system error messages (See G. *Troubleshooting Guide*)

Settings (Fig. E.2)

- Pressure control units (PSI or BAR)
- Prevent Screen Lock stops the mobile device screen from going to sleep while the app is open
- Compressor duty cycle
- Air bag type

Update Firmware

Communicate

Online Help

- Links to: AirLiftCompany.com

About (Fig. E.3)

- Shows the app software version and manifold firmware version

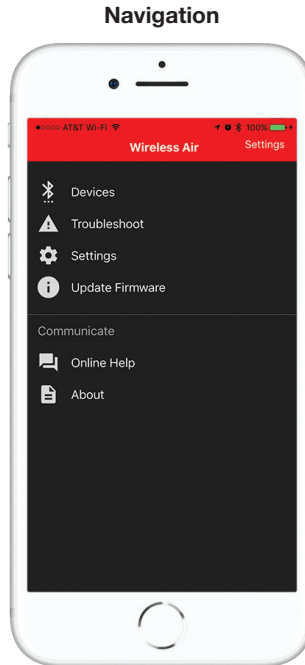

fig. E.1

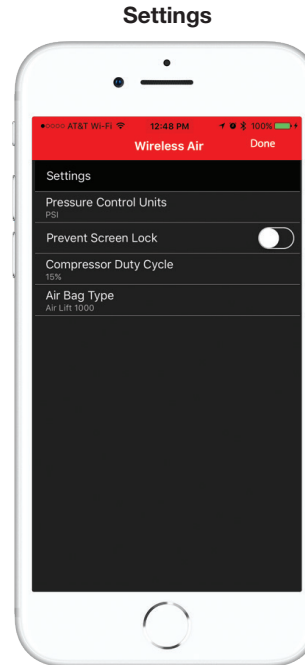

fig. E.2



fig. E.3

2. Use the “Done” button to go back to the user interface.

APP PRESETS

1. The app must be connected to the manifold to change presets (Fig. E.4). Presets are stored on the manifold, so changes made in the app will also affect the wireless controller and vice versa.
2. Adjust presets by clicking on the gear next to each preset.
3. To adjust preset values, click on the name or pressure value and type the desired name and pressure.
4. Tap the screen outside the pop-up window to save the preset and return to the main screen.
5. To select a preset, press the desired circle icon to the left of the preset name. To obtain the preset, press the circle icon a second time.

FIRMWARE UPDATES

1. Update the WirelessAir app to download the latest firmware for transfer to the manifold and wireless controller. The manifold and wireless controller need to be updated separately.
2. The app must be connected to the manifold to change firmware on the manifold (Fig. E.5). The app must be connected to the wireless controller to change firmware on the wireless controller.
3. Once connected to the manifold, Press “Manifold” and select “Start.” Wait for update to complete.
4. To update the wireless controller, enter the menu, “Pairing”, then “Update Display” on the wireless controller. From the App menu select “Firmware Update”, “Remote” and select “Next”. Click the “WARemote” and then “Pair.” Click “Start” to begin the update.

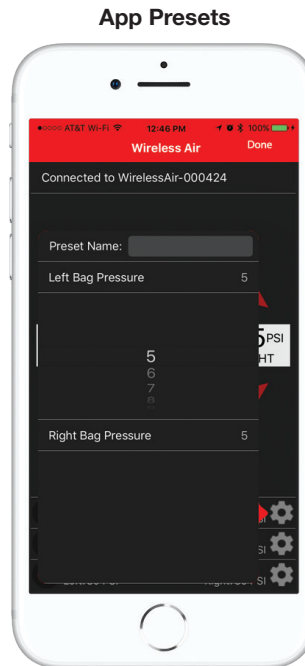

fig. E.4

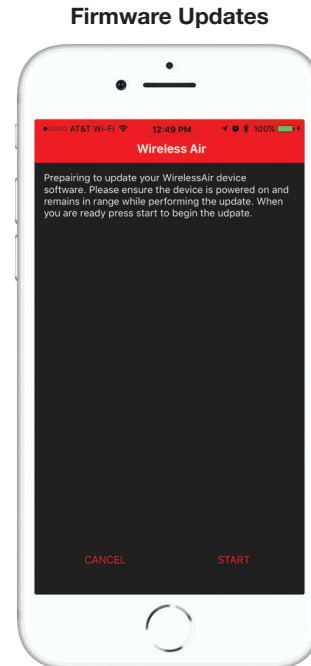

fig. E.5

F. Android App Configuration

NAVIGATION/COMMUNICATE

1. The Navigation/Communicate screen (Fig. F.1) has these options:

Navigation

Dashboard

- Closes the menu and returns to the dashboard

Devices

- Lists devices that are available for pairing

Troubleshoot

- Displays system error messages
(See G. Troubleshooting Guide)

Settings

- Pressure control units (PSI or BAR)
- Prevent Screen Lock stops the mobile device screen from going to sleep while the app is open
- Compressor duty cycle
- Air bag type

Update Firmware

Communicate

Online help

- Links to AirLiftCompany.com

About (Fig. F.2)

- Shows the app software version and manifold firmware version

2. Click off of the menu bar or press the back button to return to the dashboard.

Navigation/Communicate

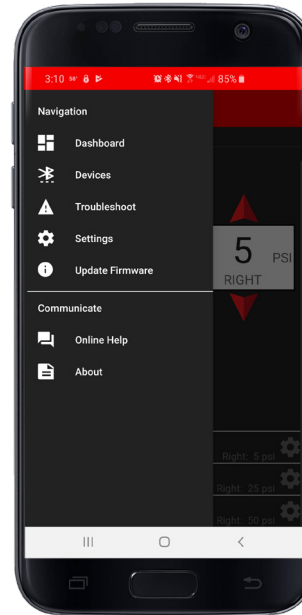

fig. F.1

About



fig. F.2

APP PRESETS

1. The app must be connected to the manifold to change presets (Fig. F.3). Presets are stored on the manifold, so changes made in the app will also affect the wireless controller and vice versa.
2. Adjust presets by clicking on the gear next to each preset.
3. To adjust preset values, click on the name or pressure value and type the desired name and pressure.
4. Click “SAVE” to save the preset or “CANCEL” to close the preset screen.
5. To select a preset, press the circle icon to the left of the preset name. To obtain a preset, press the circle icon a second time.

FIRMWARE UPDATES

1. Update the WirelessAir app to download the latest firmware for transfer to the manifold and wireless controller. The manifold and wireless controller need to be updated separately.
2. The app must be connected to the manifold to change firmware on the manifold (Fig. F.4). The app must be connected to the wireless controller to change firmware on the wireless controller.
3. Once connected to the manifold, Press “Start” and select “Manifold.” Wait for update to complete.
4. To update the wireless controller, enter the menu, “Pairing”, then “Update Display” on the wireless controller. From the App menu select “Firmware Update”, “Remote” and select “Next”. Click the “WARemote” and then “Pair.” Click “Start” to begin the update.

App Presets

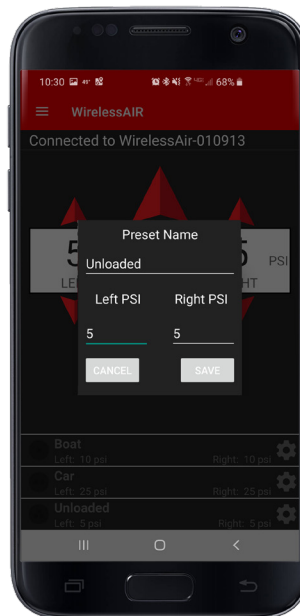

fig. F.3

Firmware Updates

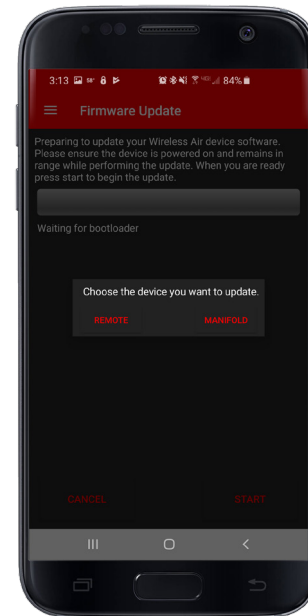

fig. F.4

G. Troubleshooting Guide

For any code not listed, contact Air Lift Customer Service at **(800) 248-0892** or service@airliftcompany.com.

Error codes are labeled “Active Errors” on the app (Fig. G.1) and wireless controller (Fig. G.2).

Check for presently active codes. Some error codes can only be cleared by pulling the fuse.



Example of an error code on the wireless controller.

fig. G.2

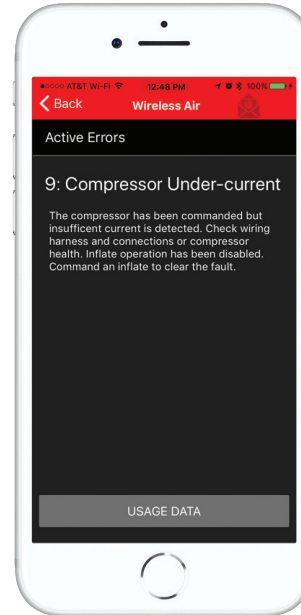
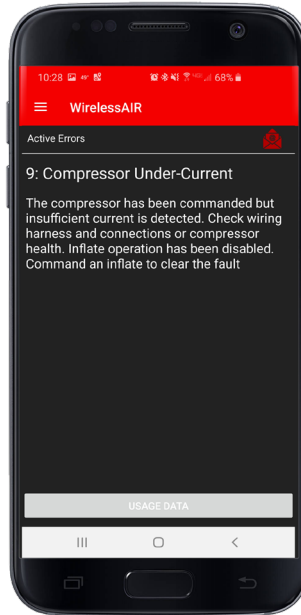

fig. G.1

Example of an error code on the smartphone app for Android (left) and iOS (right).

Troubleshooting Guide (cont.)

Problem	Error Code	Cause	Solution
<p>If the ignition wire is not connected, the system will only maintain a preset when the vehicle starts moving or is connected to the wireless controller or mobile app. If the ignition wire is connected, the system will only maintain a preset when ignition is on. The system will not maintain a preset when ignition is turned off.</p>			
Compressor doesn't run when inflation is commanded	5	Vehicle battery voltage is too low (below 9 volts)	Check the vehicle battery
	6	Vehicle battery voltage is too high (above 16 volts)	Check the vehicle battery and charging system
	3, 4	Manifold temperature is too cold	Allow manifold to warm up
	2	Manifold temperature is too hot	Allow manifold to cool down. Move manifold to location that is not near heat sources.
	9	Compressor under-current	Check battery and ground connections. Check compressor connections. Disconnect the compressor and test on the bench using 12 volts. Remove and reinstall the 15A fuse to reset the fault.
	8	Compressor over-current	Disconnect the compressor and test on the bench using 12 volts.
	7, 21	Compressor duty cycle limit has been reached	Allow the compressor to sit idle until the cool down period has been reached. The idle time required depends on the duty cycle selected.
	16	Compressor hose disconnected from manifold or blockage in the compressor or system which is preventing air flow	Check hose connections. Check for system blockages or frozen moisture in the air lines. Remove and reinstall the 15A fuse to reset the fault.

Troubleshooting Guide (cont.)

Problem	Error Code	Cause	Solution
Compressor doesn't run when inflation is commanded (continued)	20	Increased compressor current detected	Check battery and ground connections. Disconnect the compressor and test on the bench using 12V.
	-	Bad ground, poor wire connections, bad compressor or bad manifold	Disconnect the compressor and test on the bench using 12 volts
	-	Manifold inlet pressure is too high	Relieve inlet pressure by slowly loosening the compressor check valve at the end of the compressor leader hose
System does not exhaust when deflation is commanded	5	Vehicle battery voltage is too low (below 9 volts)	Check the vehicle battery
	6	Vehicle battery voltage is too high (above 16 volts)	Check the vehicle battery and charging system
	3, 4	Manifold temperature is too cold	Allow manifold to warm up
	2	Manifold temperature is too hot	Allow manifold to cool down. Move manifold to location that is not near heat sources.
	-	Manifold inlet pressure is too high	Relieve inlet pressure by slowly loosening the compressor check valve at the end of the compressor leader hose
Nothing happens when the vehicle is turned on	-	If the ignition wire is not connected, the system will only maintain a preset if the vehicle starts moving or is connected to the wireless controller or mobile app	Connect the optional ignition wire if desired. Connect to the manifold using the remote or mobile app to wake the system up for quicker adjustments.
Unable to connect to the manifold with the wireless controller	-	Wireless controller battery is low	Check wireless controller for low battery icon. Change battery if necessary (See page 22).

Troubleshooting Guide (cont.)

Problem	Error Code	Cause	Solution
Unable to connect to the manifold with the wireless controller (continued)	-	Blown 15A fuse	Check 15A fuse. Enter pairing screen on the wireless controller or devices menu on the mobile app and see if the manifold is visible via Bluetooth.
	-	Weak Bluetooth signal	Check signal strength icon. Move manifold to a location that is not shielded by metal. Try connecting with the mobile app.
	-	Wireless controller has become unpaired from the manifold	Re-pair the wireless controller by removing and re-inserting the 15A fuse. The manifold will be in pairing mode for 5 minutes after power is applied.
System does not maintain/reach ride height	16	Compressor hose disconnected from manifold or blockage in the compressor or system which is preventing air flow	Check hose connections. Check for system blockages or frozen moisture in the air lines. Remove and reinstall the 15A fuse to reset the fault.
	-	The vehicle could be overloaded	If the air pressure in the system is at its max pressure of 100 PSI (7BAR), the system will stop inflating.
Compressor runs often without commanding an inflate adjustment	17	Small air leak in the system	Locate and correct leak (See <i>Finding Air Leaks, Fixing Leaks on Barbed Fittings</i> and <i>Fixing Leaks on PTC Fittings</i>)
System does not operate after a software update	-	Software update failed to complete	Open the mobile app, go to “Devices” and select the manifold. Force a firmware update by going to “Firmware Update” in the Settings menu and proceed with the update (pages 15 & 17).
Display shows message that it is too cool	-	Display temperature is too low for proper operation	Allow display to warm up. The display will remain on in an attempt to warm up and will then power on completely.
Unable to inflate past 35 PSI (2.4BAR)	-	Air bag type is limiting the maximum/minimum pressure	Change the Air Bag Type in the Settings menu of the display or mobile app to the type installed (page 9).

REPLACING BATTERY IN THE WIRELESS CONTROLLER

1. To install or replace the CR123A battery in the wireless controller, remove the battery cover from the back of the wireless controller.
2. Remove the battery by sliding the battery toward the spring with one hand and lifting the battery out with the other hand.
3. Insert the battery with the negative side toward the spring in the wireless controller. Take note of the “-” and “+” symbols on the circuit board.
4. Replace the battery cover. There will be an audible click when the cover is fully seated.



FCC AND INDUSTRY CANADA INFORMATION TO USER

This device complies with Part 15 of the FCC Rules and with Industry Canada license-exempt RSS standard(s). Operation is subject to the following two conditions: (1) This device may not cause harmful interference, and (2) This device must accept any interference received, including interference that may cause undesired operation.

Le présent appareil est conforme aux CNR d'Industrie Canada applicables aux appareils radio exempts de licence. L'exploitation est autorisée aux deux conditions suivantes : (1) l'appareil ne doit pas produire de brouillage, et (2) l'utilisateur de l'appareil doit accepter tout brouillage radioélectrique subi, même si le brouillage est susceptible d'en compromettre le fonctionnement.

Note: Changes or modifications not expressly approved by the party responsible for compliance could void the user's authority to operate the equipment.

Remote

FCC ID: 2ANLC-EBK83016

IC: 23130-EBK83016

Manifold

FCC ID: 2ANLC-HMK122713

IC: 23130-HMK122713

FINDING AIR LEAKS

1. Inflate the air springs to 30 PSI (2.1BAR).
2. Spray all connections with a solution of liquid dish soap and water. Wait 30 seconds and check for bubbles which indicate leaks.
3. Check the air pressure again after 24 hours. A 2-4 PSI (.14-.28BAR) loss after initial installation is normal. Retest for leaks if the loss is more than 5 PSI (.34BAR).
4. After checking for leaks, deflate the springs to the minimum pressure required to restore the system to normal ride height.

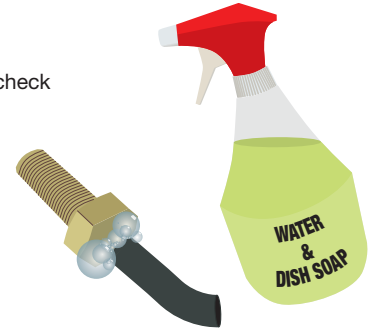

FIXING LEAKS ON BARBED FITTINGS

1. If there is a leak at the Schrader valve, tighten the valve with a valve core tool.
2. If there is a leak at any barbed fitting, cut the air line 1 1/2" (38mm) behind the fitting. Use a pair of pliers or locking pliers to twist and pull the air line off of the fitting. Do not cut the air line lengthwise at the fitting because this could nick the barbs, likely causing it to leak.
3. Reinstall the air line and the air line clamp if the fitting has one. Make sure the air line covers all barbs.



CUTTING AIR LINES

When cutting air lines, use a sharp knife or a hose cutter and make clean, square cuts. Do not use scissors or wire cutters because these tools will deform the air line, causing it to leak around fittings. Do not cut the lines at an angle.

The maximum bend radius for 1/4" air line is 1" (25mm). Do not bend the air line more than the maximum bend radius or side load the fitting connections. Air lines are to be installed straight into fittings.



FIXING LEAKS ON PTC FITTINGS

After insertion, check the PTC fitting connection by pulling on each line to verify a robust connection.

To release the air line from the connection, first release all air from the system. Push in on the air line (step 1), push the collar in (step 2), and with the collar depressed, pull the air line out of the fitting (step 3).

To reconnect, push the air line into the fitting and pull to verify a robust connection.

TIPS

- To ensure a proper seal, cut off the end of the air line just beyond the witness mark before reinstalling in the fitting.
- If the fitting is leaking at the threads, it may be necessary to remove and re-apply thread sealant on the threads and re-install 1 1/2 turns beyond finger tight.

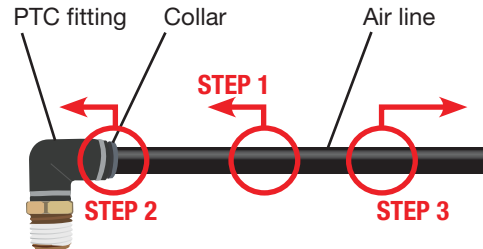



LIMITED WARRANTY AND RETURN POLICY

Air Lift Company provides a 2-year limited warranty to the original purchaser of WirelessAir™ from the date of original purchase, that the products will be free from defects in workmanship and materials when used on cars and trucks as specified by Air Lift Company and under normal operating conditions, subject to the requirements and exclusions set forth in the full Limited Warranty and Return Policy that is available online at www.airliftcompany.com/warranty.

For additional warranty information contact Air Lift Company customer service.



REPLACEMENT PART INFORMATION

If replacement parts are needed, contact the local dealer or call Air Lift customer service at (800) 248-0892. Most parts are immediately available and can be shipped the same day.

Contact Air Lift Company customer service at (800) 248-0892 first if:

- Parts are missing from the kit.
- Need technical assistance on installation or operation.
- Broken or defective parts in the kit.
- Wrong parts in the kit.
- Have a warranty claim or question.

Contact the retailer where the kit was purchased:

- If it is necessary to return or exchange the kit for any reason.
- If there is a problem with shipping if shipped from the retailer.
- If there is a problem with the price.

CONTACT INFORMATION

Mailing address P.O. Box 80167
Lansing, MI 48908-0167

Shipping address 2727 Snow Road
for returns Lansing, MI 48917

Phone Toll free: (800) 248-0892
International: (517) 322-2144

Email service@airliftcompany.com

Web address www.airliftcompany.com



Need Help?

Contact Customer Service at: (800) 248-0892
or email: service@airliftcompany.com
For calls outside the U.S. or Canada: (517) 322-2144



AD-963 • (021910) • ERN 8143 • JJC-1019 • Printed in the USA

Air Lift Company 2727 Snow Road Lansing, MI 48917

California: ⚠️ WARNING: Cancer and Reproductive Harm
- www.P65Warnings.ca.gov

