



**Installation Instructions
For Part Numbers:**

300-986 Modular Intake Tube
300-786 Jr. Kit 850-357 Airaid Oiled Media Filter
301-786 Jr. Kit 851-357 SynthaMax Dry Media Filter - Red

**2013-15 Ram 2500/3500
6.7L Cummins Diesel**

Component Identification

1	Airaid Premium Filter	1
2	Airaid Intake Tube	1
3	Hump Hose	1
5	Hose Clamp	2

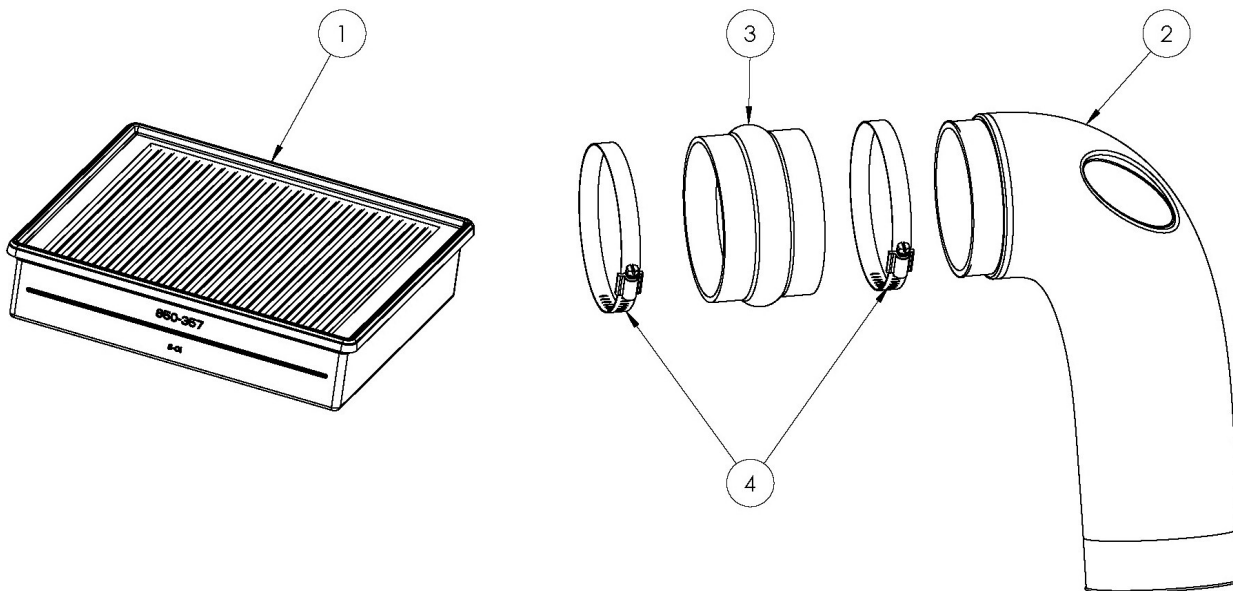

Full color instructions can be viewed on our web site at Airaid.com. Use the **Product Search** function to find your part number, and click **View Details**.

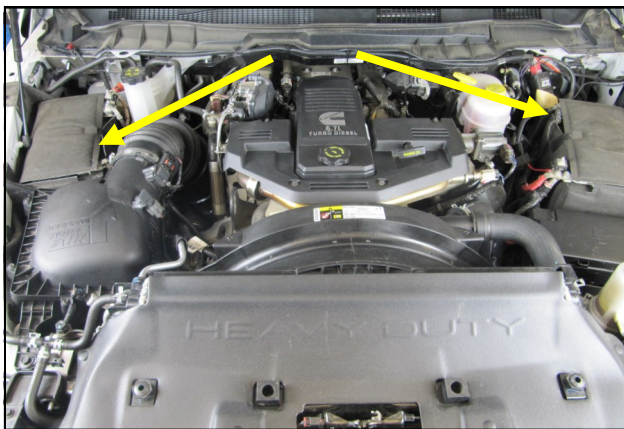

1. Disconnect The Negative Battery Terminals!
Warning: Installation of this Intake system requires working in close proximity to the turbocharger. Please allow a sufficient cooling time before beginning the installation to avoid personal injury.

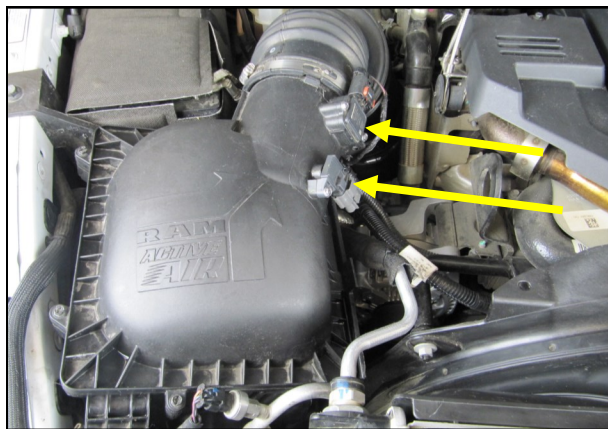

2. Disconnect both of the air sensors in the airbox top.

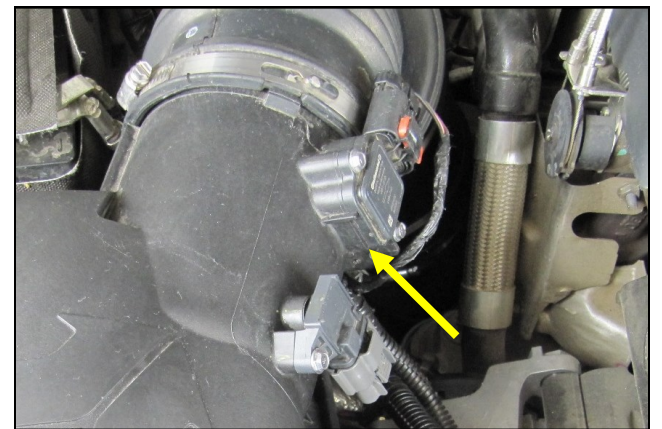

3. Gently pry the harness anchor out of its tab on the airbox and free the wire harness.



3. Loosen the clamp on the intake tube and remove the airbox lid from the vehicle.

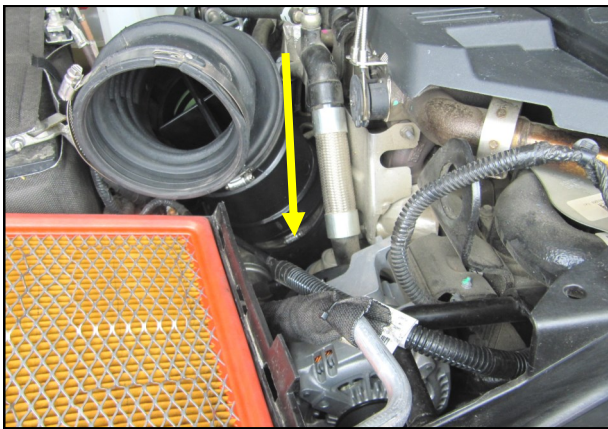

4. Loosen the intake clamp at the turbo inlet and remove the intake tube assembly.

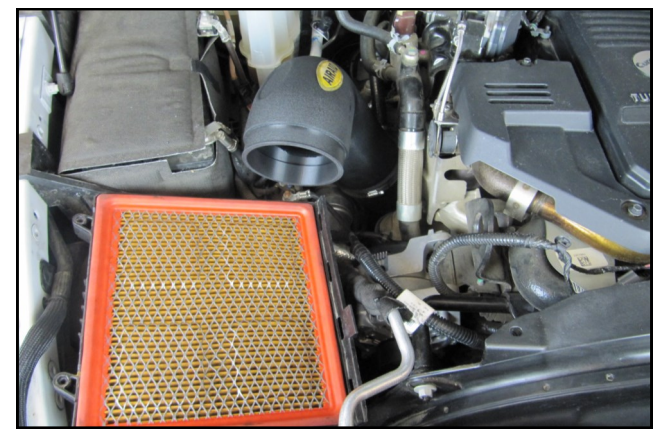

5. Slide the Airaid intake tube into the turbo inlet but leave the clamp loose for now.

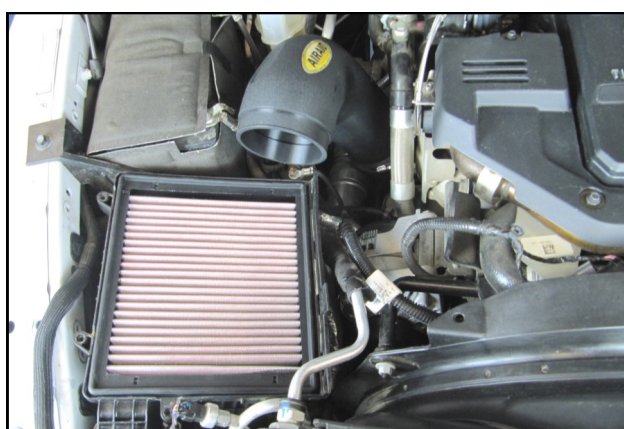

6. If you are installing an Airaid Jr. kit, install the Airaid Premium Filter at this time.



7. Slide the Hump Hose and clamps onto the Airaid Intake tube as shown.

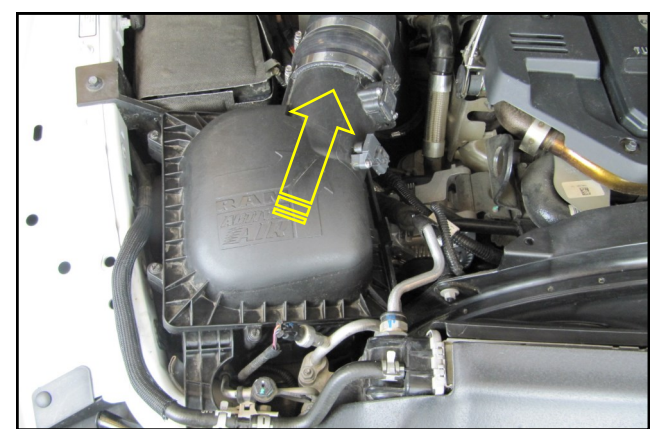

9. Slide the airbox outlet into the Hump hose and re-install the airbox lid.

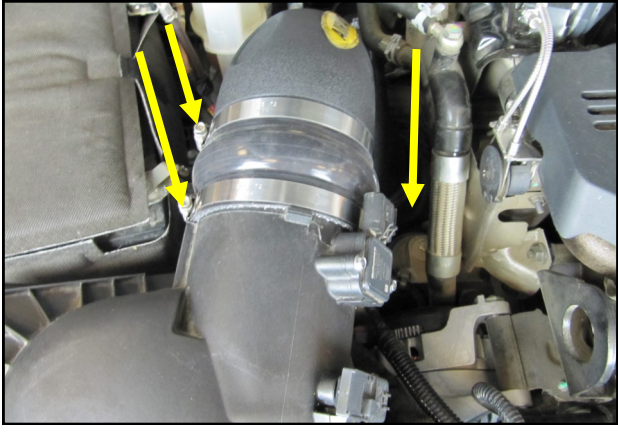

8. Tighten all three Intake Clamps at this time.

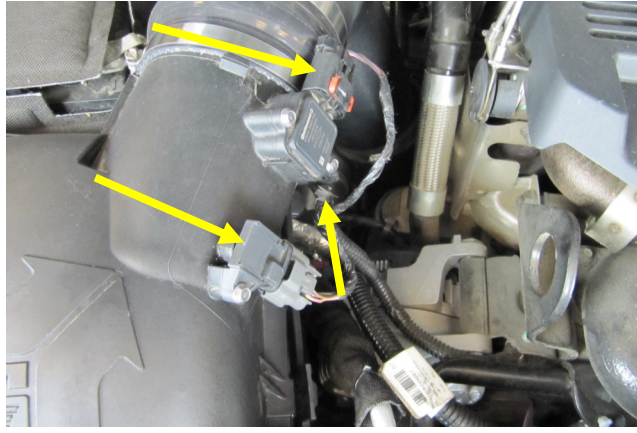

10. Reconnect the air sensors and harness anchor.



11. Double check your work. Make sure all Clamps are tight and reconnect the negative battery cables.

Thank you for purchasing the Airaid Intake System. Contact Airaid @ (800) 498-6951 8:00 AM - 5:00 PM MST weekdays for questions regarding fit or instructions that are not clear to you. Your Airaid Intake System was carefully inspected and packaged. Check that no parts are missing, or were damaged during shipping. If any parts are missing, contact Airaid. The air filter element is protected from direct exposure to water and debris; care should be taken not to drive through deep water. WATER INGESTION IS THE DRIVERS RESPONSIBILITY! The air filter is reusable and should be cleaned periodically.

FILTER IDENTIFICATION

850-357 Airaid Oiled Media

851-357 Airaid SynthaMax Dry Media - Red



Do Not Oil

Synthamax Air Filters do not require oil. Service air filter as needed by cleaning with common non-petroleum all-purpose household cleaner and water. Simple Green®, Formula 409® or equivalent works great. Apply cleaner to outside of air filter and allow to soak. Then flush filter clean from the inside out with a garden hose and repeat steps if necessary. Do not apply high pressure water or air to clean filter. Allow filter to air dry and reinstall.

For your Oiled media filter we suggest using the AIRAID Filter Tune-Up Kit!

P/N 790-551 Aerosol Spray
P/N 790-550 Squeeze Spray

