



Installation Instructions

For Part Numbers:

310-170	700-458 Airaid Oiled Media Filter
311-170	701-458 SynthaMax Dry Media Filter - Red
312-170	702-458 SynthaMax Dry Media Filter - Black
313-170	703-458 SynthaMax Dry Media Filter - Blue

2005-10 Jeep Grand Cherokee
5.7L V8, 6.1L V8 Hemi

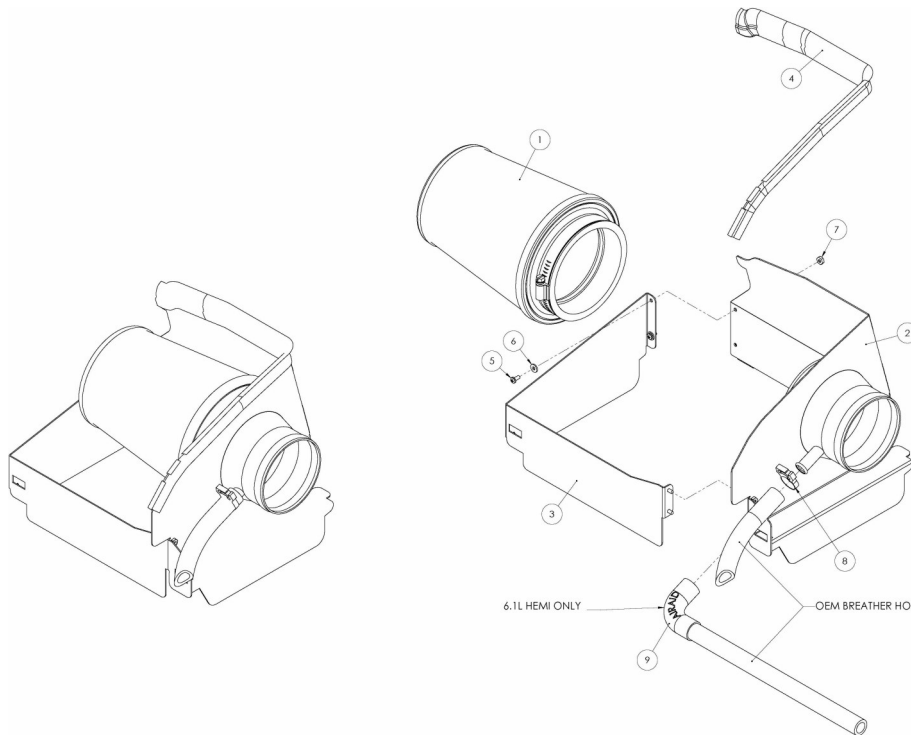

Component Identification

1.	Airaid Premium Filter	1
2.	MAF Panel	1
3.	Front Panel	1
4.	Weather Strip 17 1/2"	1
5.	6-32 x 5/16" Screw	4
6.	#6 Flat Washer	4
7.	6-32 Keps Nut	4
8.	Speed Clamp	1
9.	1/2" x 90° Elbow	1

Full color instructions can be viewed on our web site at Airaid.com. Use the **Product Search** function to find your part number, and click **View Details**.

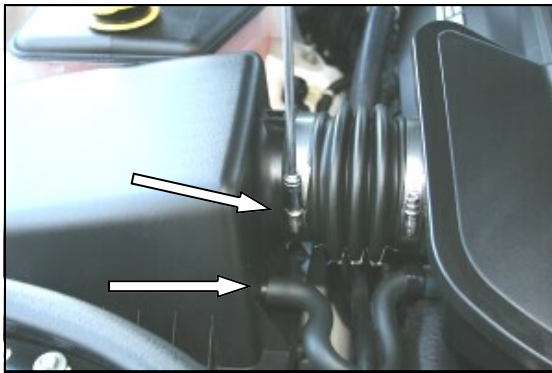

1. Disconnect the negative battery cable.
Using a 5/16" socket, loosen the hose clamp on the factory airbox lid. Twist and remove the breather hose from the factory airbox lid.

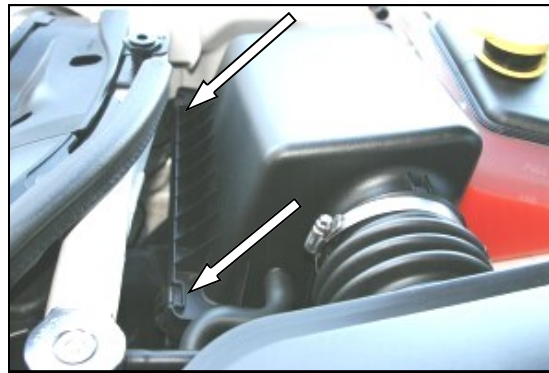

2. Unlatch the two clips on the front of the factory airbox lid.



3. Remove the factory airbox lid by sliding it forward, and then up and out of the factory intake tube.



4. Remove the factory air filter from the airbox base.

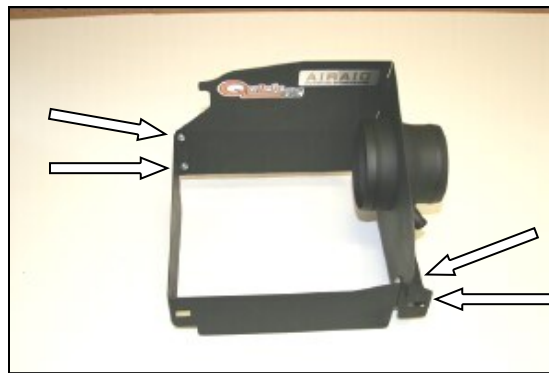

5. Assemble the Quick Fit Panels (#2, #3) using four 6-32 x 5/16" screws (#5), #6 flat washers (#6), and 6-32 keps nuts (#7).

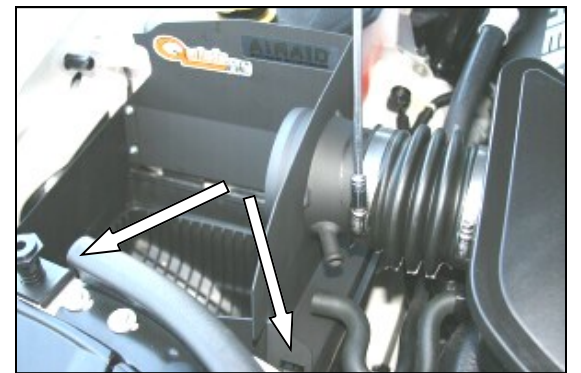

6. Install the Quick Fit Panels by sliding the four tabs on the back of the panels into the factory airbox base, and then into the factory intake tube. Relatch the two factory clips into the slots on the front of the Quick Fit Panels. Tighten the hose clamp on the factory intake tube.

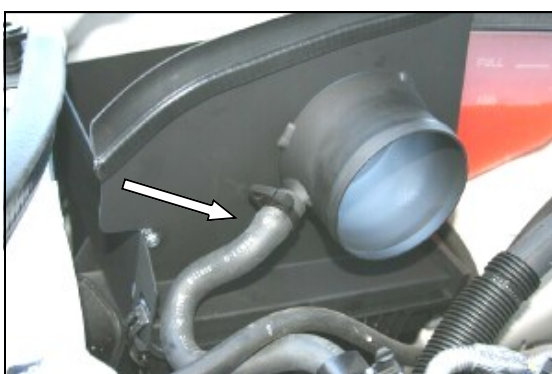

7. Re-install the breather hose and speed clamp (#8) onto the nipple on the Quick Fit Panel. If you are working on a 6.1L, install the 1/2" x 90° elbow (#9) from the breather hose to the nipple on the Quick Fit Panel.



8. Install the Airaid Premium Filter (#1) onto the tube on the Quick Fit Panels, and tighten the clamp.

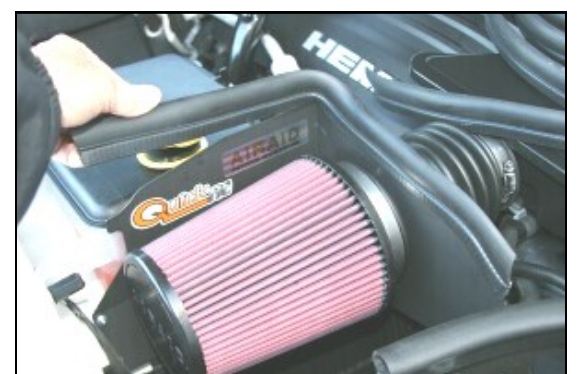

9. Install the weather strip (#4) onto the top of the Quick Fit Panels. (Hint: For ease of installation, start at one end and work your way to the other).

10. Double check your work!

Make sure there is no foreign material in the intake path. Make sure all clamps, hoses, bolts, and screws are tight.

11. Reconnect the negative battery cable!

Thank you for purchasing the Airaid Intake System. Contact Airaid @ (800) 498-6951 8:00 AM - 5:00 PM MST weekdays for questions regarding fit or instructions that are not clear to you. Your Airaid Intake System was carefully inspected and packaged. Check that no parts are missing, or were damaged during shipping. If any parts are missing, contact Airaid. The air filter element is protected from direct exposure to water and debris; care should be taken not to drive through deep water. WATER INGESTION IS THE DRIVERS RESPONSIBILITY! The air filter is reusable and should be cleaned periodically.

FILTER IDENTIFICATION

700-458 Airaid Oiled Media
702-458 Airaid SynthaMax Dry Media - Black

701-458 Airaid SynthaMax Dry Media - Red
703-458 Airaid SynthaMax Dry Media - Blue

For your Oiled media filter
we suggest using the
AIRAID Filter Tune-Up Kit!



P/N 790-551 Aerosol Spray
P/N 790-550 Squeeze Spray



SynthaMax[®]

Do Not Oil

Synthamax Air Filters do not require oil. Service air filter as needed by cleaning with common non-petroleum all-purpose household cleaner and water. Simple Green[®], Formula 409[®] or equivalent works great. Apply cleaner to outside of air filter and allow to soak. Then flush filter clean from the inside out with a garden hose and repeat steps if necessary. Do not apply high pressure water or air to clean filter. Allow filter to air dry and reinstall.

