



## Installation Instructions

For Part Numbers:

400-278	700-469 Airaid Oiled Media Filter
401-278	701-469 SynthMax Dry Media Filter - Red
402-278	702-469 SynthMax Dry Media Filter - Black
403-278	703-469 SynthMax Dry Media Filter - Blue

2011-14 Ford F-250/350 /450 Pickup  
6.7L V8

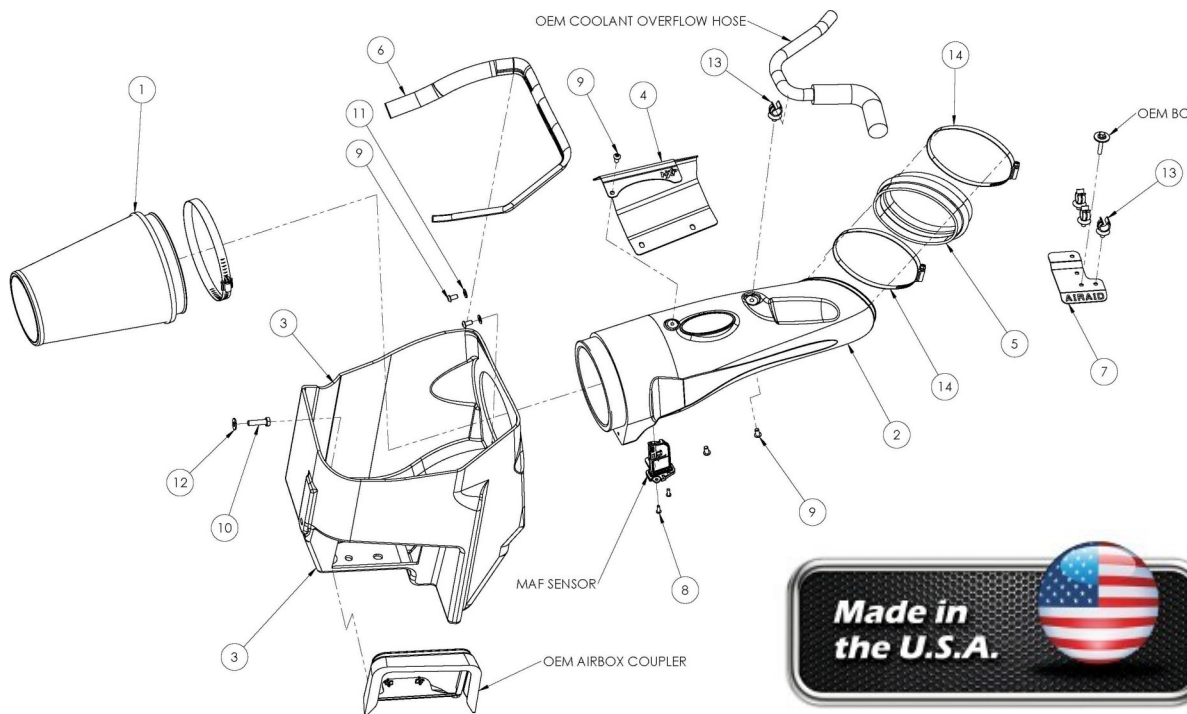

### Component Identification

1.	Airaid Premium Filter	1
2.	Airaid Intake Tube	1
3.	Cold Air Box	1
4.	Heat Shield	1
5.	Silicone Hump Hose	1
6.	Weather Strip 24 1/2"	1
7.	Hose Bracket	1
8.	#8-32 x 1/2" Button Head Bolt	2
9.	1/4-20 x 1/2" Button Head Bolt	5
10.	M8 x 1.25 x 30 Hex Head Bolt	1
11.	1/4" Flat Washer	2
12.	8mm Flat Washer	1
13.	Hose Anchor	4
14.	#72 Hose Clamp	2
15.	5/8" x 9" Split Loom	1
16.	5/8" x 17" Split Loom	1
17.	T-20 Torx Driver	1

Full color instructions can be viewed on our web site at [Airaid.com](http://Airaid.com). Use the **Product Search** function to find your part number, and click **View Details**.



#### 1. Disconnect both of the negative battery cables.

**Caution: Engine and turbo plumbing can be very hot.**

It is advised that you allow your self a 20-30 minute cool down time before beginning this installation.

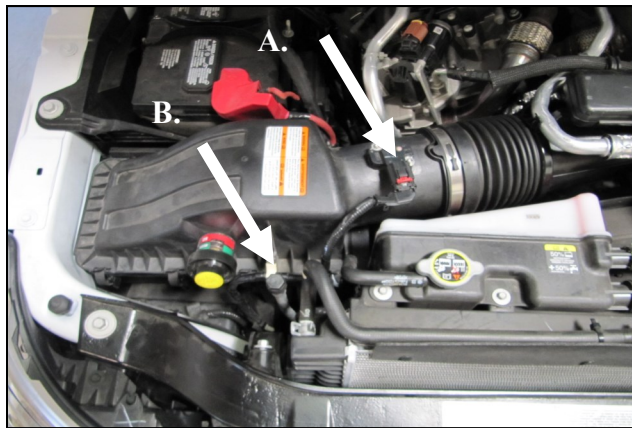

#### 2. A.) Disconnect the Mass Air Flow meter, or M.A.F. B.) Using a standard blade screwdriver, pry open the edge clip securing the M.A.F. wire harness to the upper half of the factory airbox.

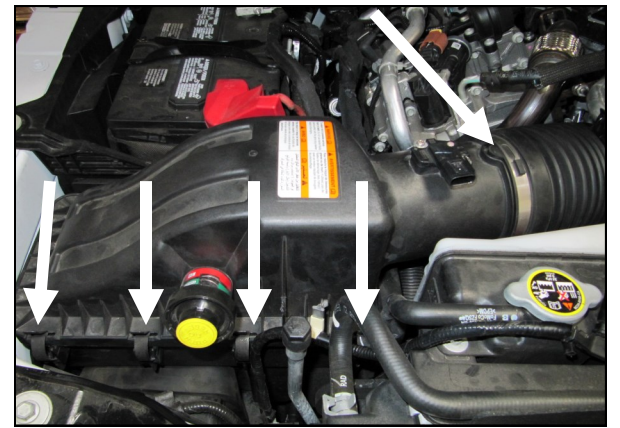

#### 3. Loosen the clamp on the intake tube. Unfasten the four airbox clips and remove the upper airbox half and the factory airfilter.

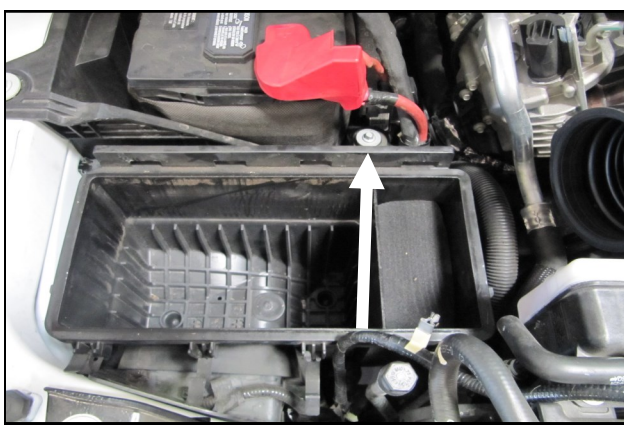

#### 4. Using a 10mm socket, remove the 6mm bolt securing the lower half of the airbox to the vehicle. Remove the airbox from the vehicle.



#### 5. Using a 13mm socket, remove the 8mm inner fender bolt.

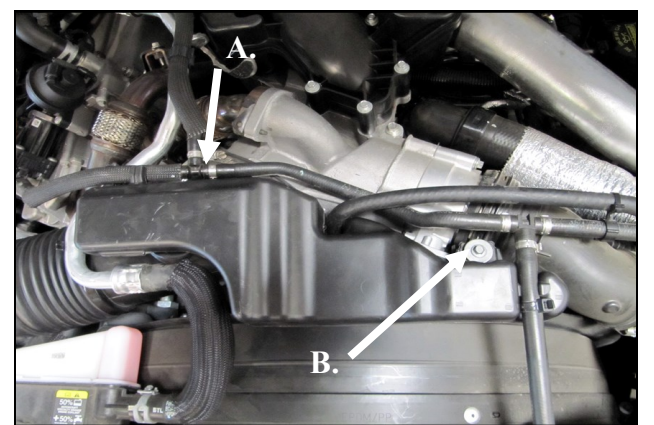

#### 6. A.) Loosen the clamp on the factory intake tube. B.) Using a 10mm socket, remove the 6mm bolt securing the intake resonator. Save this bolt, it will be re-used in step 16.



#### 7. Unclip the coolant hoses from the intake tube and resonator, and remove it from the vehicle.

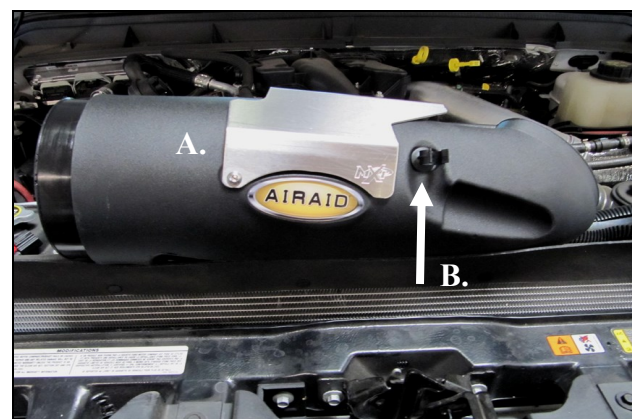

#### 8. A.) Attach the Heat Shield (#4) to the Airaid Intake Tube (#2) as shown using three 1/4-20 Button Head Bolts (#9). B.) Insert one Hose Anchor (#13) into the threaded insert in the Intake Tube.



#### 9. Transfer the Mass Air Flow sensor, or M.A.F., from the factory airbox lid into the Airaid Intake Tube and secure using the supplied 8-32 x 1/2 Button Head Bolts (#8). Do Not Use The Factory Hardware.



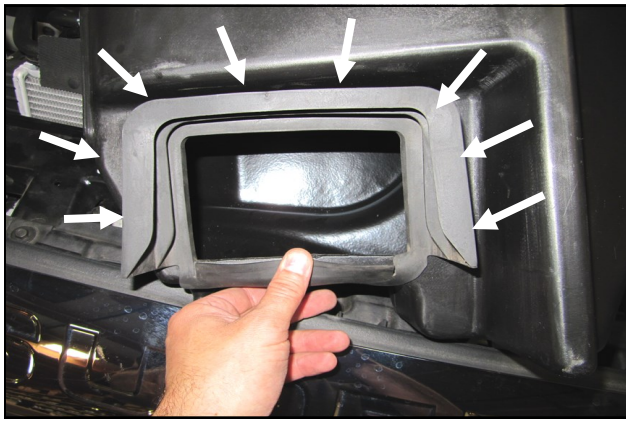

10. Transfer the factory airbox coupler from the OEM airbox inlet into the Airaid Cold Air Box, or C.A.B.(#3).

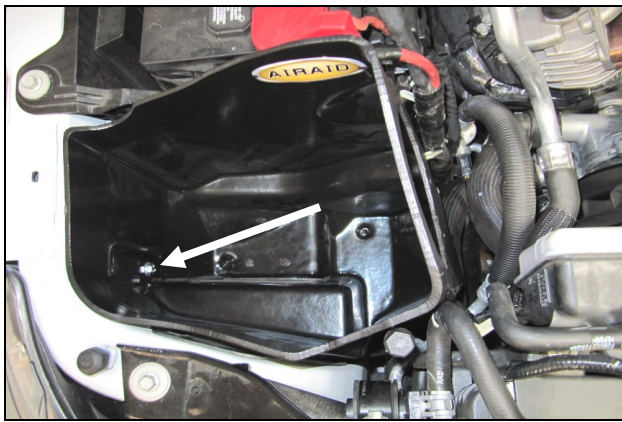

11. Place the CAB into the engine compartment and secure to the inner fender using the M8 x 1.25 x 30 hex Head Bolt (#10) and the 8mm Flat washer (#12).



12. Slide the Hump Hose (#5) and Clamps (#14) onto the Airaid Intake Tube. Leave the clamps loose for now.



13. Install the Airaid Intake Tube assembly. A.) Slide the Tube, Hump Hose end first, under the coolant line and onto the turbo inlet. B.) Insert the Filter end of the Tube into the CAB.

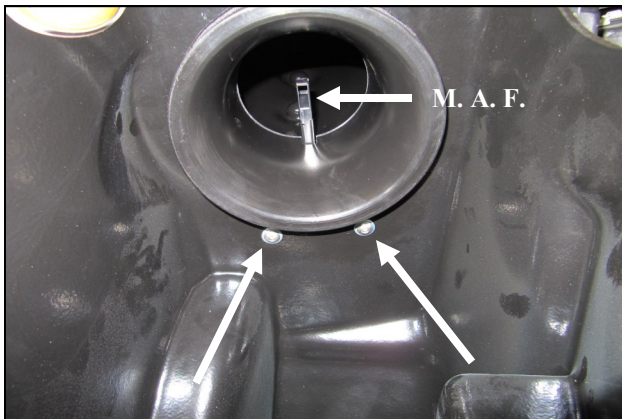

14. Align the bolt holes of the Intake tube with the CAB and secure using two 1/4-20 Button Head Bolts (#9) and 1/4" Flat Washers (#11). Tighten the Hump Hose Clamps, and re connect the Mass Air Flow sensor. The M.A.F now resides in the lower half of the Tube.

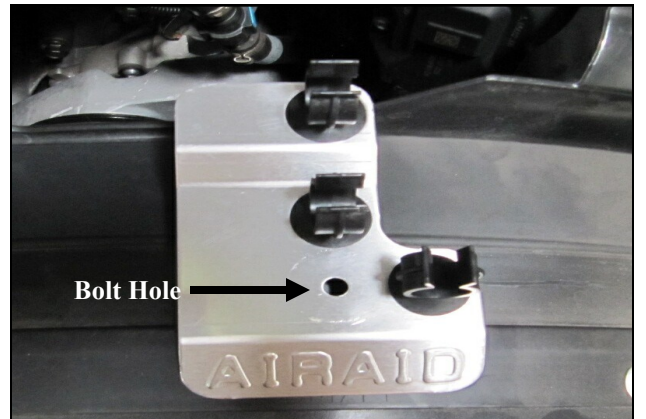

15. Insert the three remaining Hose Anchors (#13) into the Hose Bracket (#7) as shown.



16. Mount the Hose Bracket as shown, using the factory bolt removed in step 6. . Secure the coolant lines in the Hose Anchors.

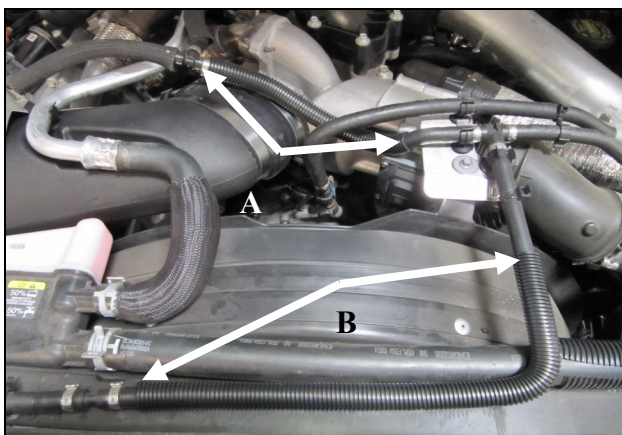

17. Slide the Split Loom over the coolant lines. A.) Install the 9" sleeve (#15) over the line crossing the turbo inlet. B.) Install the 17" sleeve (#16) over the 90deg core support line that joins at the Hose bracket.



18. Install the Airaid Premium Filter (#1) inside the CAB and complete the install by trimming the CAB with the Weather Strip (#6).

**19. Double check your work!**

Make sure there is no foreign material in the intake path. Make sure all clamps, hoses, bolts, connectors, and screws are tight.

**20. Reconnect the negative battery cables**

Thank you for purchasing the Airaid Intake System. Contact Airaid @ (800) 498-6951 8:00 AM - 5:00 PM MST weekdays for questions regarding fit or instructions that are not clear to you. Your Airaid Intake System was carefully inspected and packaged. Check that no parts are missing, or were damaged during shipping. If any parts are missing, contact Airaid. The air filter element is protected from direct exposure to water and debris; care should be taken not to drive through deep water. WATER INGESTION IS THE DRIVERS RESPONSIBILITY! The air filter is reusable and should be cleaned periodically.

**FILTER IDENTIFICATION**

700-469 Airaid Oiled Media  
702-469 Airaid SynthaMax Dry Media - Black

701-469 Airaid SynthaMax Dry Media - Red  
703-469 Airaid SynthaMax Dry Media - Blue

**For your Oiled media filter we suggest using the AIRAID Filter Tune-Up Kit!**



P/N 790-551 Aerosol Spray  
P/N 790-550 Squeeze Spray



**Do Not Oil**

Synthamax Air Filters do not require oil. Service air filter as needed by cleaning with common non-petroleum all-purpose household cleaner and water. Simple Green®, Formula 409® or equivalent works great. Apply cleaner to outside of air filter and allow to soak. Then flush filter clean from the inside out with a garden hose and repeat steps if necessary. Do not apply high pressure water or air to clean filter. Allow filter to air dry and reinstall.