



Installation Instructions

For Part Numbers:

| | |
|---------|--|
| 400-299 | 720-478 Airaid Oiled Media Filter |
| 401-299 | 721-478 SynthaMax Dry Media Filter - Red |
| 402-299 | 722-478 SynthaMax Dry Media Filter - Black |
| 403-299 | 723-478 SynthaMax Dry Media Filter - Blue |

2011-14 Ford F-150 5.0L V8

Component Identification

| | | |
|-----|--------------------------------|---|
| 1. | Airaid Premium Filter | 1 |
| 2. | Air Meter Tube | 1 |
| 3. | Airaid Intake Tube | 1 |
| 4. | Front Panel | 1 |
| 5. | Rear Panel | 1 |
| 6. | Hump Hose | 1 |
| 7. | Silicone Reducer | 1 |
| 8. | 22" Weather strip | 1 |
| 9. | 1/4-20 x 1/2" Button Head Bolt | 2 |
| 10. | 1/4" Flat Washer | 2 |
| 11. | #8-32 x 1/2" Button Head Screw | 2 |
| 12. | #6-32 x 5/16 Pan Head Screw | 4 |
| 13. | #6 Flat Washer | 4 |
| 14. | #6-32 Kep Nut | 4 |
| 15. | #56 Hose Clamp | 1 |
| 16. | #60 Hose Clamp | 2 |
| 17. | #64 Hose Clamp | 1 |
| 18. | Grommet | 1 |
| 19. | PCV Fitting | 1 |
| 20. | 1/4 NPT to 3/8" Hose Fitting | 1 |
| 21. | T-20 Torx Bit | 1 |

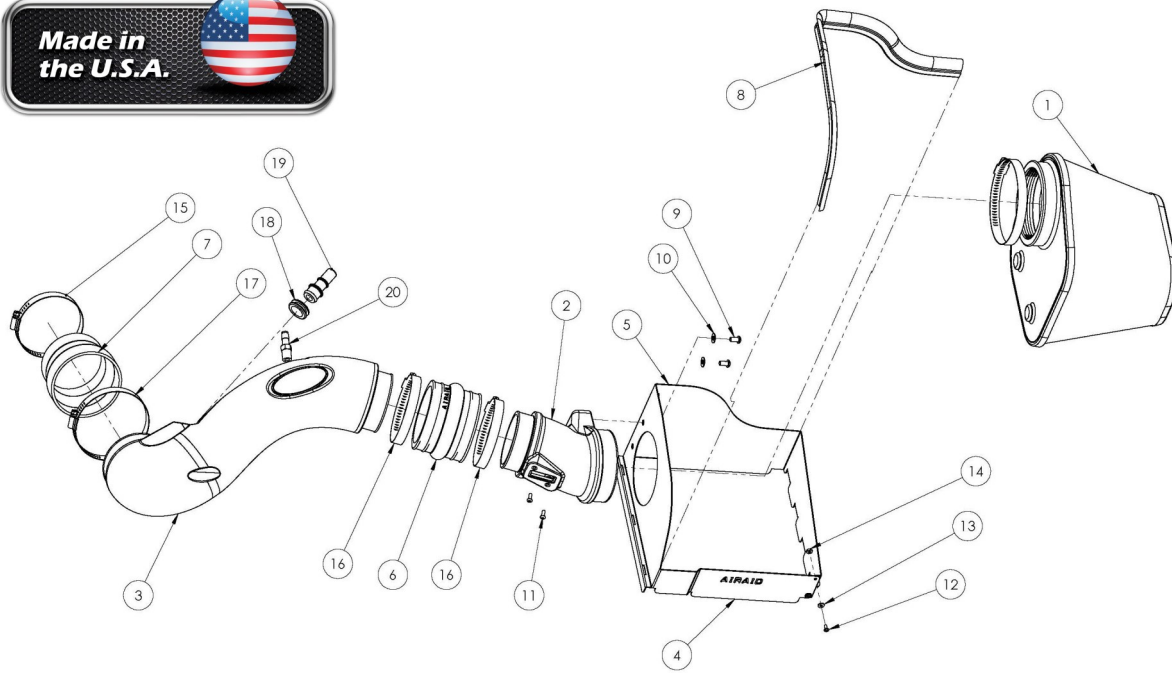

Full color instructions can be viewed on our web site at Airaid.com. Use the **Product Search** function to find your part number, and click **View Details**.

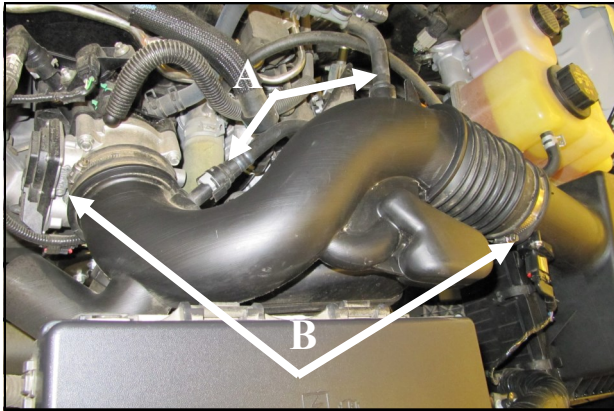

- 1. Disconnect the negative battery cable!**
A. Disconnect the two breather lines in the factory intake tube.
B. Loosen the two intake clamps, and remove the factory intake tube.

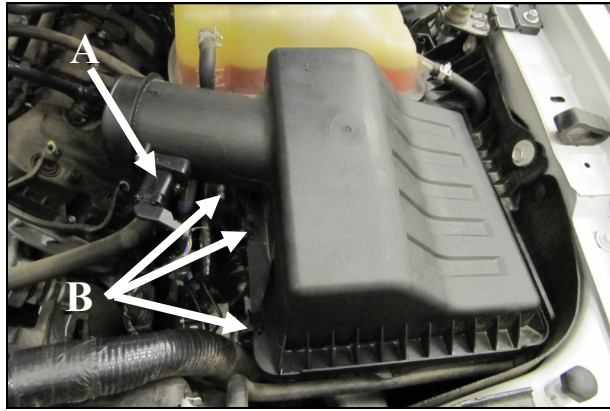

- 2. A.)** Disconnect the Mass Air Flow (MAF) Sensor.
B.) Unfasten the three clips on the left side of the factory airbox, and remove the upper half of the factory airbox.

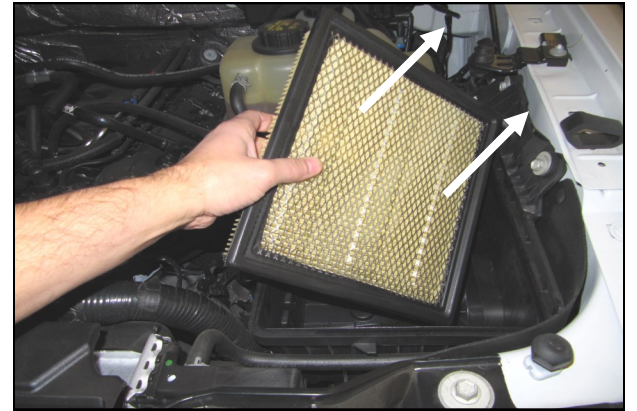

- 3.** Remove the factory air filter from the lower half of the airbox.

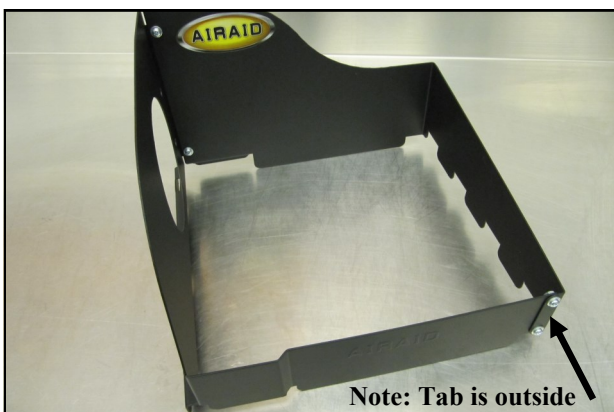

- 4.** Assemble the two Quick Fit Panels (#4 & #5) as shown using four 6-32 screws (#12), flat washers (#13), and Kep Nuts (#14). The panel tabs are to be on the outside of the assembly.



- 5.** Install the Air Meter Tube (#2) onto the Panel Assembly and secure using the two 1/4-20 Button Head Bolts (9), and 1/4" Flat Washers (#10).

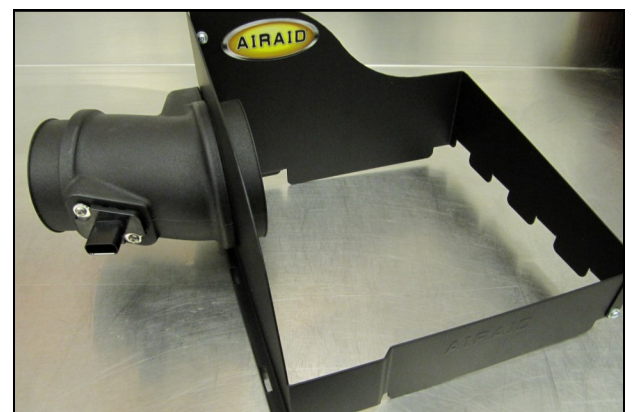

- 6.** Transfer the MAF sensor into the Airaid Intake Tube and secure using two 8-32 x 1/2" button head screws (#10). **Do Not Use The Factory Torx Head Screws.**

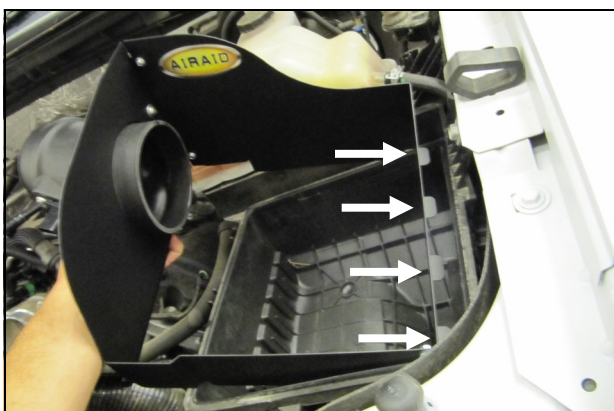

- 7.** Install the assembly onto the lower half of the factory airbox. Slide the metal tabs into the airbox slots, and fasten the 3 airbox clips



- 8. A.)** Insert the 5/8" Grommet (#18) into the Intake tube as shown. Complete the tube assembly by inserting the 5/8 PCV Fitting (#16) into the Grommet.
B.) Install the 3/8" Hose Fitting (#20) into the threaded hole in the Intake Tube.



- 9.** Install the Silicone Reducer (#7) and Hose clamps onto the Airaid Intake Tube (#2). Place the #56 clamp (#15) on the Throttle body side of the reducer, and the #64 clamp (#17) on to the tube side.



10. Install the hump hose (#6) and two #60 hose clamps (#16) onto the filter Air Meter Tube as shown. Leave the two hose clamps loose for now



11. Install the Intake Tube onto the throttle body first, then into the Hump Hose. Tighten all of the hose clamps.



12. Reconnect the breather lines to the Airaid Intake Tube.

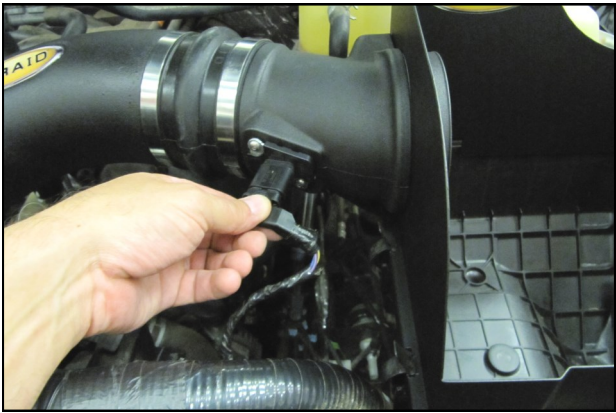

13. Reconnect the Mass Air Flow meter.

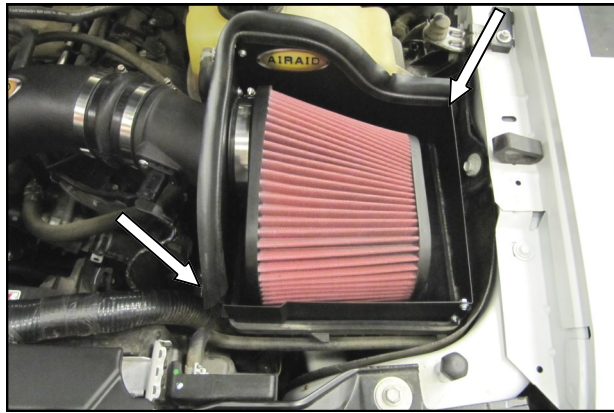

14. Install the Weather Strip (#8) onto the panel assembly with the contoured edge rolling away from the filter area. Start at the front of the vehicle and work your way back. Complete the installation by sliding the Airaid Premium Filter (#1) onto the Air Meter Tube and tightening the clamp.

15. Double check your work!

Make sure there is no foreign material in the intake path. Make sure all clamps, hoses, bolts, and screws are tight. Make sure all clamps, hoses, bolts, and screws are tight. Periodically check the tightness of all hose clamps.

16. Re-connect the negative battery cable!

Thank you for purchasing the Airaid Intake System. Contact Airaid @ (800) 498-6951 8:00 AM - 5:00 PM MST weekdays for questions regarding fit or instructions that are not clear to you. Your Airaid Intake System was carefully inspected and packaged. Check that no parts are missing, or were damaged during shipping. If any parts are missing, contact Airaid. The air filter element is protected from direct exposure to water and debris; care should be taken not to drive through deep water. WATER INGESTION IS THE DRIVERS RESPONSIBILITY! The air filter is reusable and should be cleaned periodically.

FILTER IDENTIFICATION

720-478 Airaid Oiled Media
722-478 Airaid SynthaMax Dry Media - Black

721-478 Airaid SynthaMax Dry Media - Red
723-478 Airaid SynthaMax Dry Media - Blue

For your Oiled media filter we suggest using the AIRAID Filter Tune-Up Kit!



P/N 790-551 Aerosol Spray
P/N 790-550 Squeeze Spray



SynthaMax

Do Not Oil

Synthamax Air Filters do not require oil. Service air filter as needed by cleaning with common non-petroleum all-purpose household cleaner and water. Simple Green®, Formula 409® or equivalent works great. Apply cleaner to outside of air filter and allow to soak. Then flush filter clean from the inside out with a garden hose and repeat steps if necessary. Do not apply high pressure water or air to clean filter. Allow filter to air dry and reinstall.