



## Installation Instructions

For Part Numbers:

- 510-173 700-458 Airaid Oiled Media Filter
- 511-173 701-458 SynthaMax Dry Media Filter - Red
- 512-173 702-458 SynthaMax Dry Media Filter - Black
- 513-173 703-458 SynthaMax Dry Media Filter - Blue

2005-06 Toyota Tundra

2005-07 Toyota Sequoia

4.7L V8

### Component Identification

1.	Airaid Premium Filter	1
2.	MAF Panel	1
3.	Back Panel	1
4.	MAF Adapter	1
5.	MIT Intake Tube	1
6.	3 1/2" to 3 3/8" x 2 Reducer	1
7.	3 1/2" x 3" Hump Hose	1
8.	1/2" x 13" Hose	1
9.	Weather Strip 22"	1
10.	# 52 Hose Clamp	2
11.	# 60 Hose Clamp	2
12.	1/4" Barbx1/8" NPT	1
13.	1/4" x 1/4" x 1/8" Vacuum Tee	1
14.	1/4" ID x 4" Hose	1
15.	6-32 x 5/16" Screw	3
16.	#6 Flat Washer	3
17.	6-32 Keps Nut	3
18.	1/4" x 20 Button Head Bolt	3
19.	1/4" Flat Washer	3
20.	8-32 Button Head Bolt	2
21.	Hose Mount	1

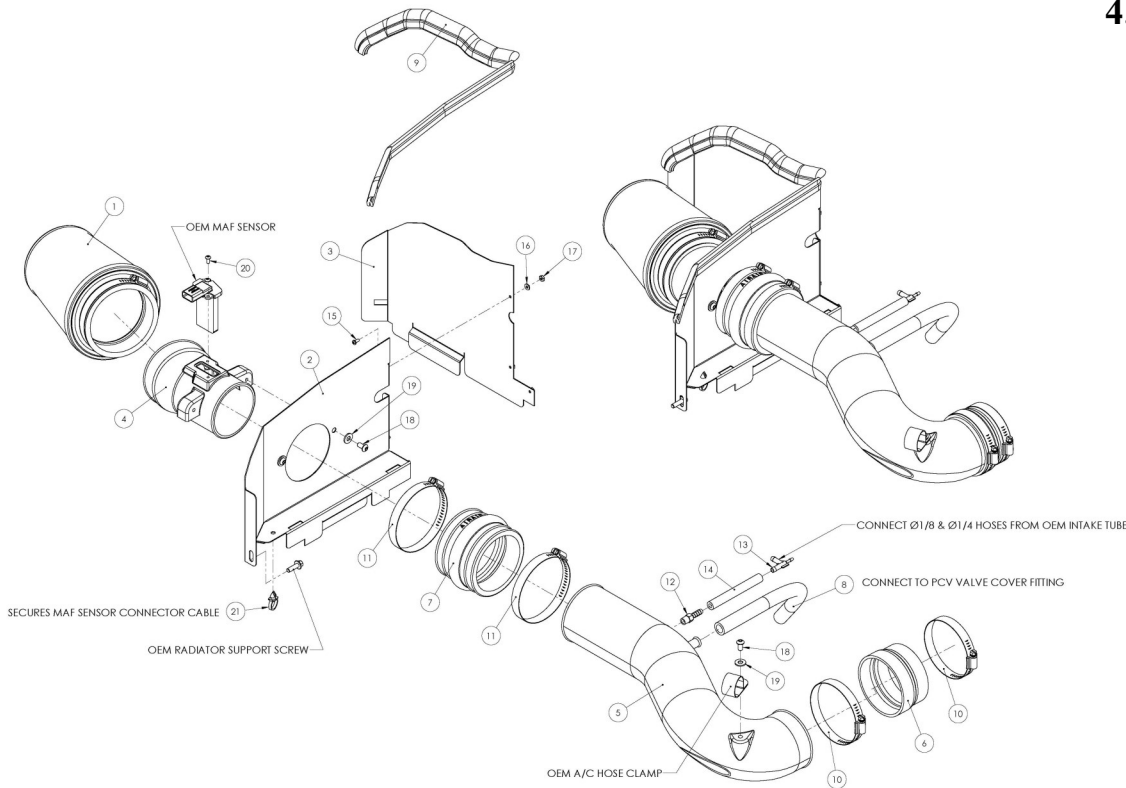

Full color instructions can be viewed on our web site at [Airaid.com](http://Airaid.com). Use the **Product Search** function to find your part number, and click **View Details**.



#### 1. Stage I

##### Disconnect negative battery cable.

Remove 2 screws and remove and set aside the Mass Air Flow sensor from the factory airbox. Unclip wire harness from intake tube. (See arrow)



2. Loosen hose clamp where intake tube connects to the airbox.

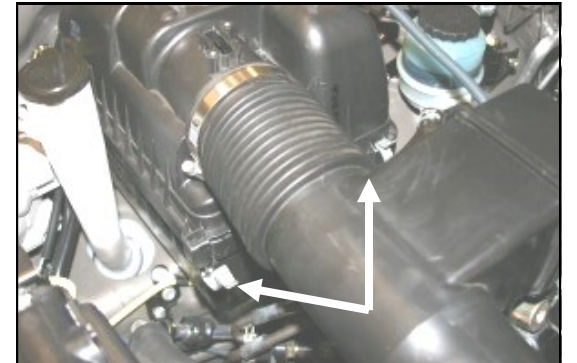

3. Unlatch 4 clips on factory airbox



4. Remove factory airbox lid, and filter.

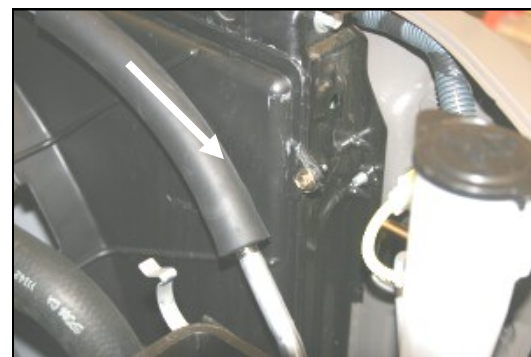

5. Remove fan shroud bolt on passenger side of radiator, save for later use.



6. Assemble Cool Air Dam (#2) & (#3) using three screws (#15), washers (#16), and nuts (#17). Install MAF adapter (#4) using two button head bolts (#18), and washers (#19), as shown.



7. Slip MAF adapter into factory intake tube while installing CAD onto top of factory airbox. Adjust for fit, and latch 3 factory clips on factory airbox. Tighten the hose clamp on the intake tube. Replace the fan shroud bolt that was removed in step #5.



8. Re-route MAF wire harness under the intake tube, and around the front of the airbox. Install MAF sensor into the MAF adapter, using two supplied button head screws (#20). **DO NOT USE FACTORY SCREWS!**

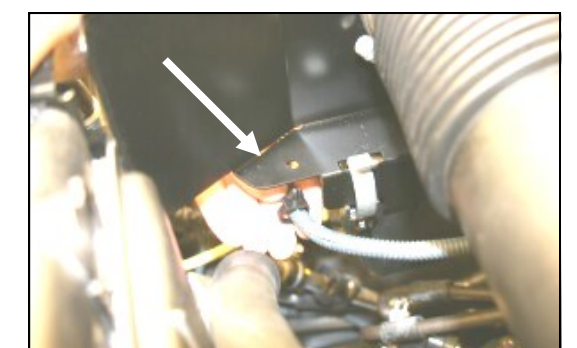

9. Slip hose mount (#21) over MAF wire harness, and into hole in bottom of CAD. This will keep the harness from chafing.





10. Install the Airaid Premium Filter (#1) on the MAF adapter. Next install the weather strip (#9) on the CAD as shown. Start at the front, next to the radiator, and work your way towards the back.

### 11. Stage II

For maximum airflow and aggressive sound from your vehicle, proceed with installing the Airaid Modular Intake Tube (#5). The MIT can be added or taken off of the vehicle at any time depending on your preference. If you choose not to install the MIT, skip to step #19 below.

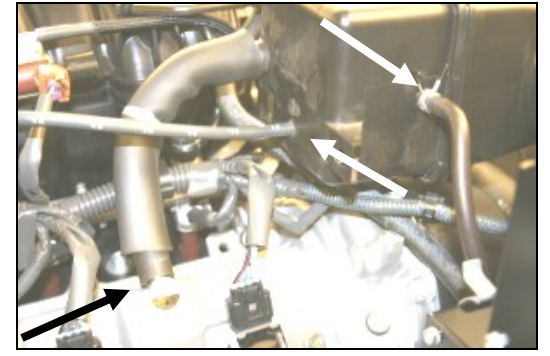

12. Disconnect breather hose from valve cover. Disconnect 1/8" vacuum line, and 1/4" vacuum line from the back of the factory intake tube.



13. Remove two 10mm nuts, and the beauty cover from the top of the engine. Remove one bolt thru the Adel clamp that holds the air conditioning hose to the intake tube. Loosen hose clamps on each end of the factory intake tube.



14. Remove the factory intake tube.



15. Install the hump hose (#7) on the MAF adapter (#4) with two hose clamps (#11). Install the reducer (#6), small end first, onto the throttle body with two hose clamps (#10). Leave the clamps loose for now.

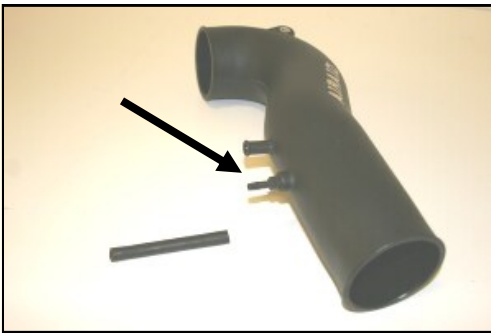

16. Install the barbed fitting (#11) into the MIT as shown, and then slide the 1/4"x4" hose (#13) over the fitting.



17. Install the MIT (#5) into the hump hose (#7), and then into the reducer (#6). Adjust the MIT snugly against the throttle body, and tighten all 4 hose clamps. Install the supplied button head bolt (#18), and washer (#19), thru the Adel clamp and into the MIT to hold the air conditioning hose.

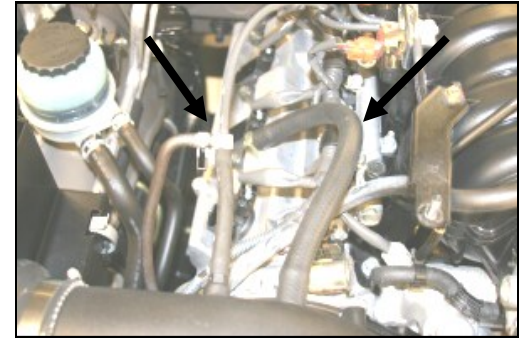

18. Install the vacuum tee (#13) into the 1/4"x4" hose (#14), and reconnect the factory 1/4" and 1/8" vacuum lines to the tee as shown. Install the 1/2"x13" breather hose (#8) onto the valve cover and to the MIT as shown.

### 19. Double check your work!

Make sure there is no foreign material in the intake path. Make sure all clamps, hoses, bolts, and screws are tight.

### 20. Reconnect the negative battery cable!

Thank you for purchasing the Airaid Intake System. Contact Airaid @ (800) 498-6951 8:00 AM - 5:00 PM MST weekdays for questions regarding fit or instructions that are not clear to you. Your Airaid Intake System was carefully inspected and packaged. Check that no parts are missing, or were damaged during shipping. If any parts are missing, contact Airaid. The air filter element is protected from direct exposure to water and debris; care should be taken not to drive through deep water. WATER INGESTION IS THE DRIVERS RESPONSIBILITY! The air filter is reusable and should be cleaned periodically.

### FILTER IDENTIFICATION

700-458 Airaid Oiled Media  
702-458 Airaid SynthaMax Dry Media - Black

For your Oiled media filter we suggest using the AIRAID Filter Tune-Up Kit!



P/N 790-551 Aerosol Spray  
P/N 790-550 Squeeze Spray



701-458 Airaid SynthaMax Dry Media - Red  
703-458 Airaid SynthaMax Dry Media - Blue

*SynthaMax*

### Do Not Oil

Synthamax Air Filters do not require oil. Service air filter as needed by cleaning with common non-petroleum all-purpose household cleaner and water. Simple Green®, Formula 409® or equivalent works great. Apply cleaner to outside of air filter and allow to soak. Then flush filter clean from the inside out with a garden hose and repeat steps if necessary. Do not apply high pressure water or air to clean filter. Allow filter to air dry and reinstall.