



Installation Instructions

For Part Numbers:

510-307	700-474 Airaid Oiled Media Filter
511-307	701-474 SynthaMax Dry Media Filter - Red
512-307	702-474 SynthaMax Dry Media Filter - Black
513-307	703-474 SynthaMax Dry Media Filter - Blue

2013 Scion FR-S and Subaru BRZ 2.0L Boxer 4



Component Identification

1.	Airaid Premium Filter	1
2.	Cold Air Box	1
3.	Intake Tube	1
4.	Filter Adapter	1
5.	Hump Hose	1
6.	Reducer	1
7.	Air Box Lid	1
8.	Lid Gasket	1
9.	MAF Harness Grommet	1
10.	Air Box Bracket	1
11.	1/4-20 x 1/2" Button Head Cap Screw	4
12.	1/4" Flat Washer	5
13.	10-24 Button Head Cap Screw	4
14.	#10 Washer	4
15.	M6 Flange Nut	1
16.	M6 CAB Mount	1
17.	8-32 Socket Head Cap Screw	2
18.	Spacer	2
19.	#44 Hose Clamp	1
20.	#52 Hose Clamp	3
21.	1/4" NPT x 1/2" Barb Elbow	1
22.	Firewall Grommet (Not Pictured)	1

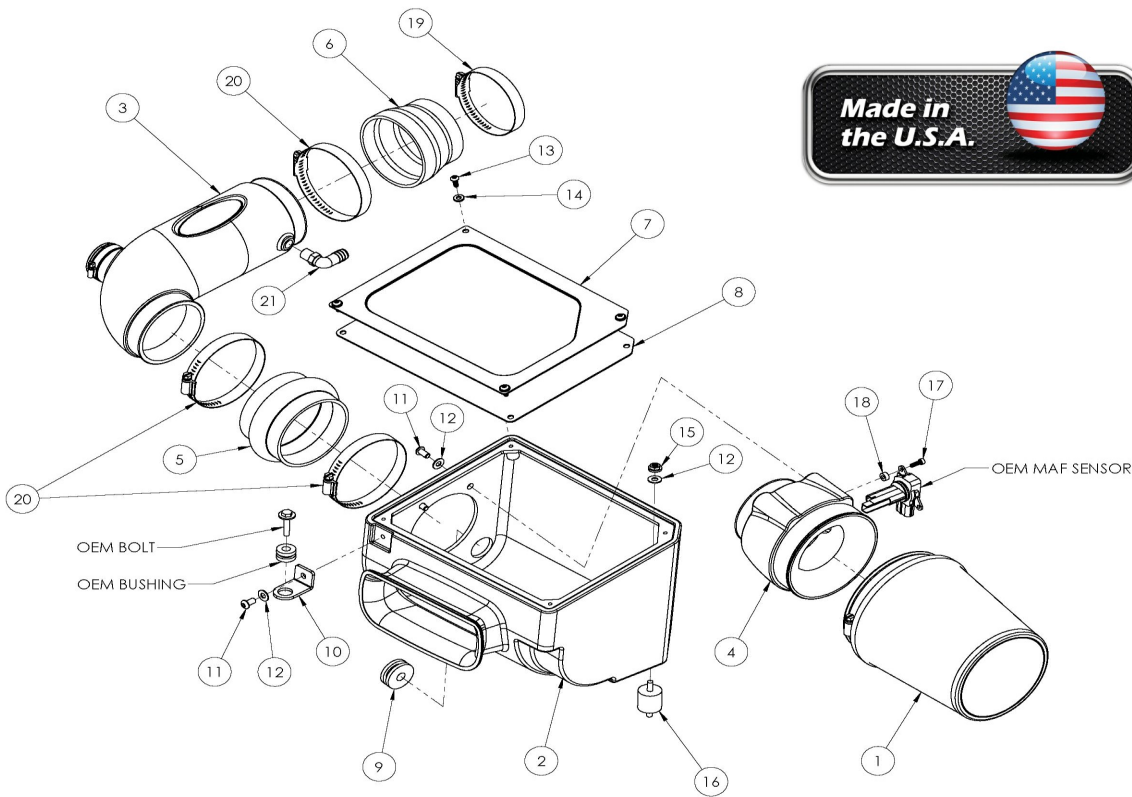

Full color instructions can be viewed on our web site at Airaid.com. Use the **Product Search** function to find your part number, and click **View Details**.

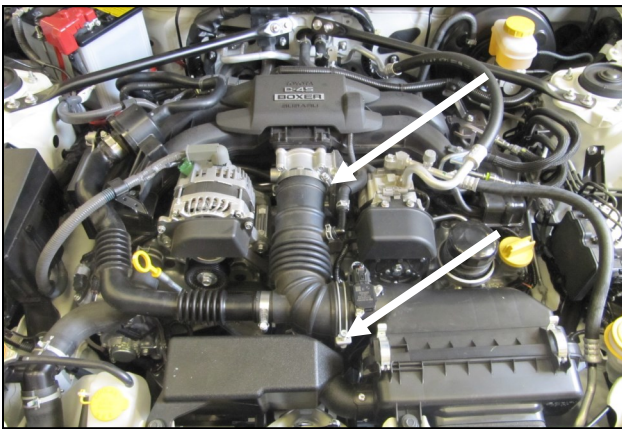

Disconnect The Negative Battery Terminal!

1. Loosen the clamps on the throttle body and the airbox outlet.

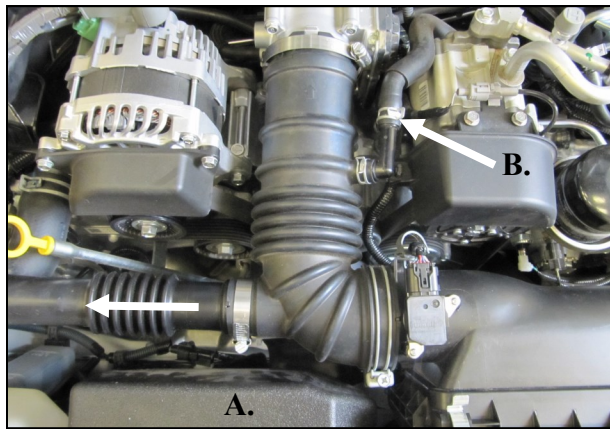

2. **A.** Loosen the resonator tube clamp and disconnect it from the intake. **B.** Compress the spring clamp on the crank case breather line and disconnect it. Remove the intake tube from the vehicle.

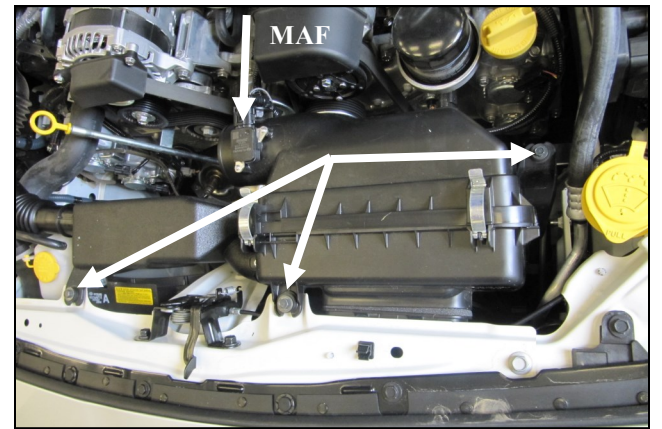

3. Disconnect the Mass Air Flow sensor, or MAF, in the airbox. Remove the three 6mm bolts securing the airbox assembly and remove it from the vehicle.



4. Transfer the Mass Air Flow sensor into the Filter Adapter (#4) and secure using the two 8-32 Socket Head Screws (#17) and Spacers (#18).

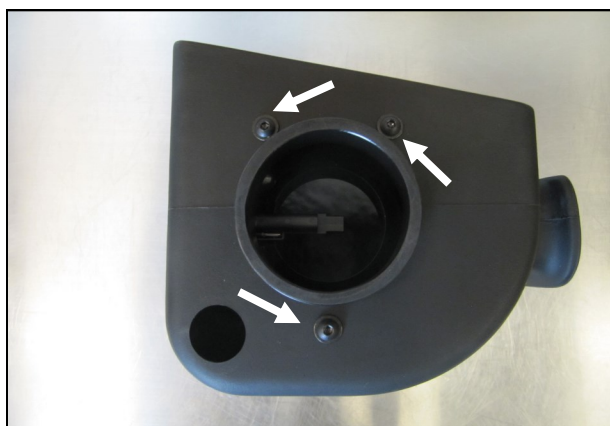

5. Install the Filter Adapter into the Cold Air Box (#2) as shown using the 1/4-20 Button Head Screws (#11) and 1/4" Flat Washers (#12).



6. Install the CAB Mount (#16) into the airbox bracket on the inner fender. Hand tight is sufficient.

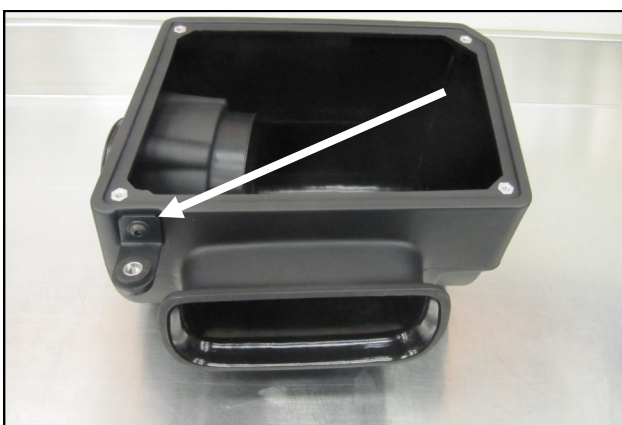

7. Mount the Airbox Bracket (#10) as shown, using one 1/4-20 Button Head Screw and a 1/4" Flat Washer. Transfer one factory airbox mounting grommet and steel sleeve from step 3 into the Airbox Bracket.

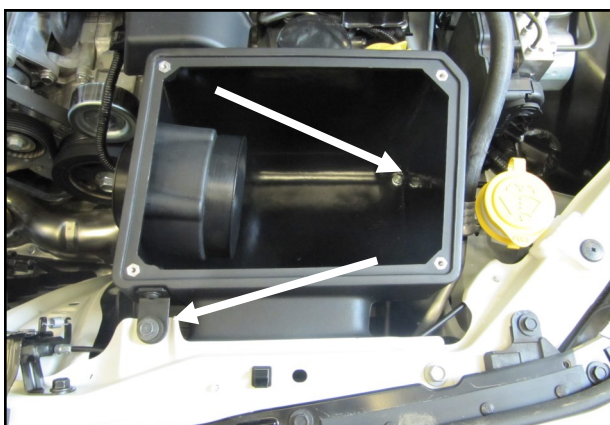

8. Slide the CAB Mount stud through the hole in the Airbox bottom and secure it using the M6 Flange Nut (#15) and a 1/4" Flat washer. Reuse one 6mm airbox bolt from step 3 to join the Airbox Bracket to the core support.



9. Using a pair of diagonal cutters, or similar, split the Harness Grommet (#9).

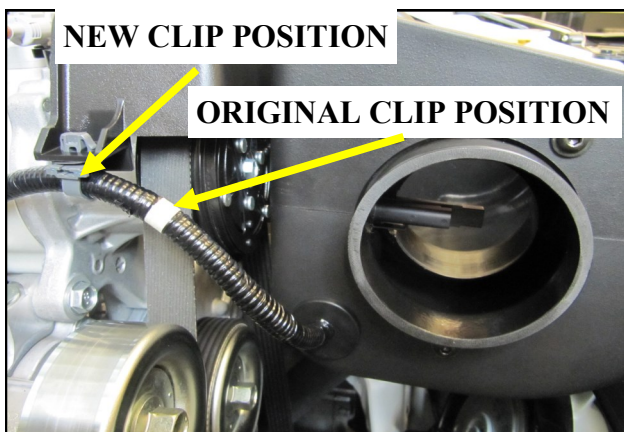

10. Route the MAF harness into the Airbox and reconnect the sensor inside. Seal off the access port with the Grommet from step 9. Relocate the plastic clip on the wire harness 1/4" back to take up any slack that might allow contact with the accessory belt.

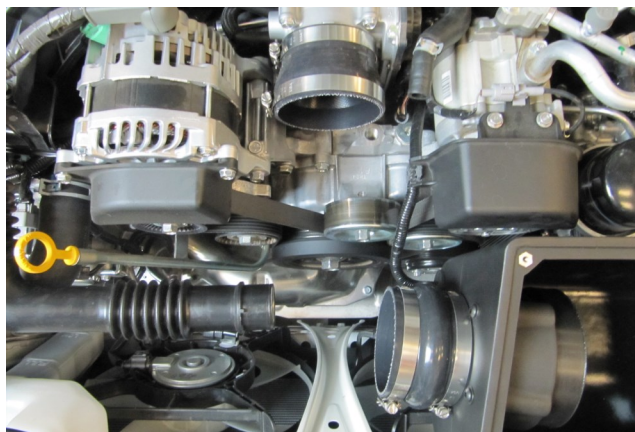

11. Place the Hump Hose (#5) and two #52 Clamps (#20) onto the Filter Adapter and the Reducer (#6) with one #52 and one #44 Clamp (#19) on the throttle body. Leave the clamps loose for now.

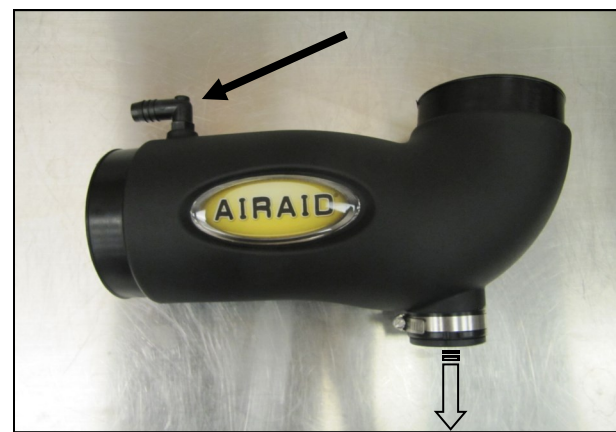

12. Install the Barbed Fitting (#21) into the Intake Tube as shown. Remove the aluminum Plug in the Tube if the Resonator is to be retained.



13. Install the Intake Tube and tighten all of the clamps. Connect the crank case breather to the Barbed Fitting and secure it using the OEM spring clamp. Insert the resonator into the Intake Tube and tighten the clamp.

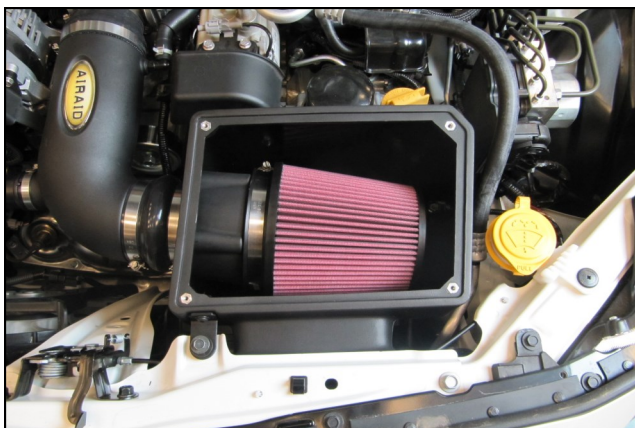

14. Install the Airaid Premium Filter onto the Filter Adapter.

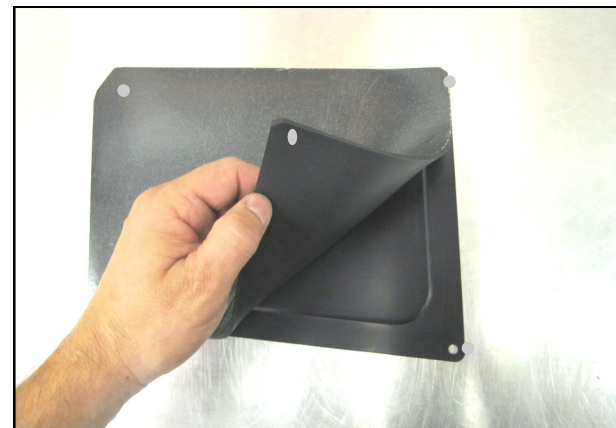

15. Carefully install the Gasket (#8) onto the Air Box Lid (#7).



16. Install the Air Box Lid using the 10-24 Button Head Screws and the #10 Washers.

NOTE: Airaid recommends the use of LOCTITE® 242® Medium Strength Thread locker or equivalent on the Air Box Lid hardware.

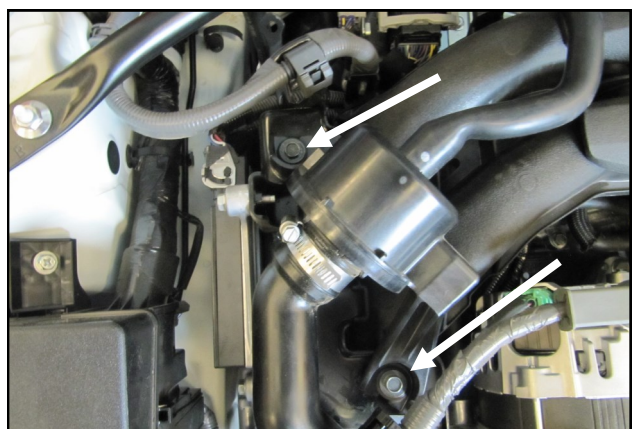

17. Install Option One: Resonator Delete. Remove the two 6mm bolts in the diaphragm housing and pull the sound tube out of the fire wall. Remove the entire resonator as an assembly. The Aluminum Plug will be utilized with this option (See Step 12). It should be noted that the Aluminum is designed to accept many 1/16 NPT N2O foggers.

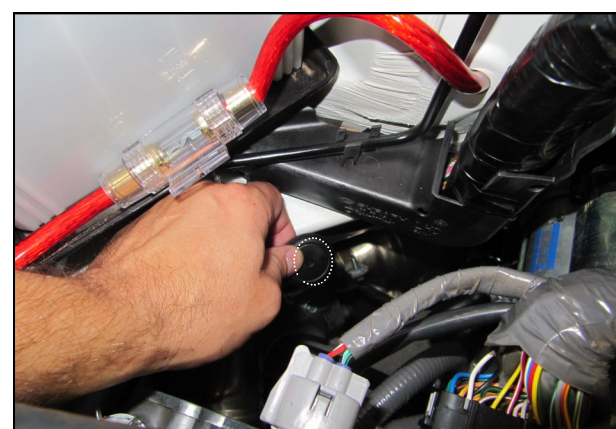

18. Place the Firewall Grommet into the bulkhead. **NOTE:** The resonator Delete option has no positive or negative effect on performance

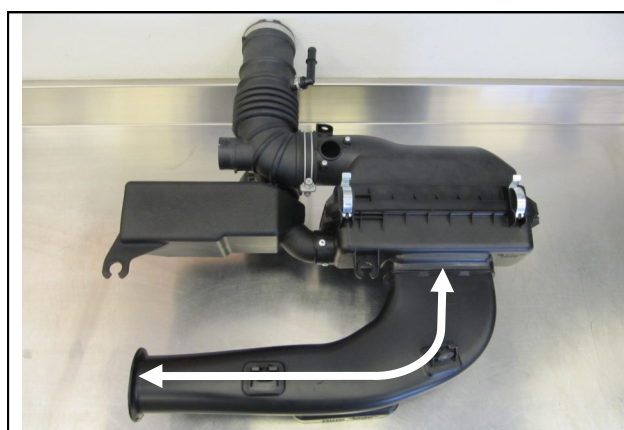

19. Install Option Two: OEM air inlet removal. While not necessary, maximum power is achieved by removing the OEM inlet from the vehicle.



20. With help from an assistant. The inlet can be removed with out removing the entire bumper cover. Simply remove all of the topside fasteners and pull back on the cover. Have an assistant remove the two 6mm bolts in the tube and remove.



Double check your work ! Make sure there is no foreign material in the intake path. Make sure all clamps, hoses, bolts, and screws are tight. Double check the hood clearance!

Thank you for purchasing the Airaid Intake System. Contact Airaid @ (800) 498-6951 8:00 AM - 5:00 PM MST weekdays for questions regarding fit or instructions that are not clear to you. Your Airaid Intake System was carefully inspected and packaged. Check that no parts are missing, or were damaged during shipping. If any parts are missing, contact Airaid. The air filter element is protected from direct exposure to water and debris; care should be taken not to drive through deep water. WATER INGESTION IS THE DRIVERS RESPONSIBILITY! The air filter is reusable and should be cleaned periodically.

FILTER IDENTIFICATION

700-474 Airaid Oiled Media
702-474 Airaid SynthaMax Dry Media - Black

701-474 Airaid SynthaMax Dry Media - Red
703-474 Airaid SynthaMax Dry Media - Blue

For your Oiled media filter we suggest using the AIRAID Filter Tune-Up Kit!



P/N 790-551 Aerosol Spray
P/N 790-550 Squeeze Spray



Do Not Oil
Synthamax Air Filters do not require oil. Service air filter as needed by cleaning with common non-petroleum all-purpose household cleaner and water. Simple Green®, Formula 409® or equivalent works great. Apply cleaner to outside of air filter and allow to soak. Then flush filter clean from the inside out with a garden hose and repeat steps if necessary. Do not apply high pressure water or air to clean filter. Allow filter to air dry and reinstall.