



Installation Instructions

For Part Numbers:

520-152	700-458 Airaid Oiled Media Filter
521-152	701-458 SynthaMax Dry Media Filter - Red
522-152	702-458 SynthaMax Dry Media Filter - Black
523-152	703-458 SynthaMax Dry Media Filter - Blue

2004-13 Nissan Titan / Armada

2004-10 Infiniti QX56

5.6L V8

Component Identification

1.	Airaid Premium Filter	1
2.	MAF Panel	1
3.	Front Panel	1
4.	Air Filter Adapter	1
5.	Weather Strip 27"	1
6.	6-32 x 5/16" Screw	4
7.	#6 Flat Washer	4
8.	6-32 Keps Nut	4
9.	1/4-20 x 1/2" Button Head Bolt	2
10.	1/4" Flat Washer	2
11.	8-32 x 1/2" SS Button Screw	2

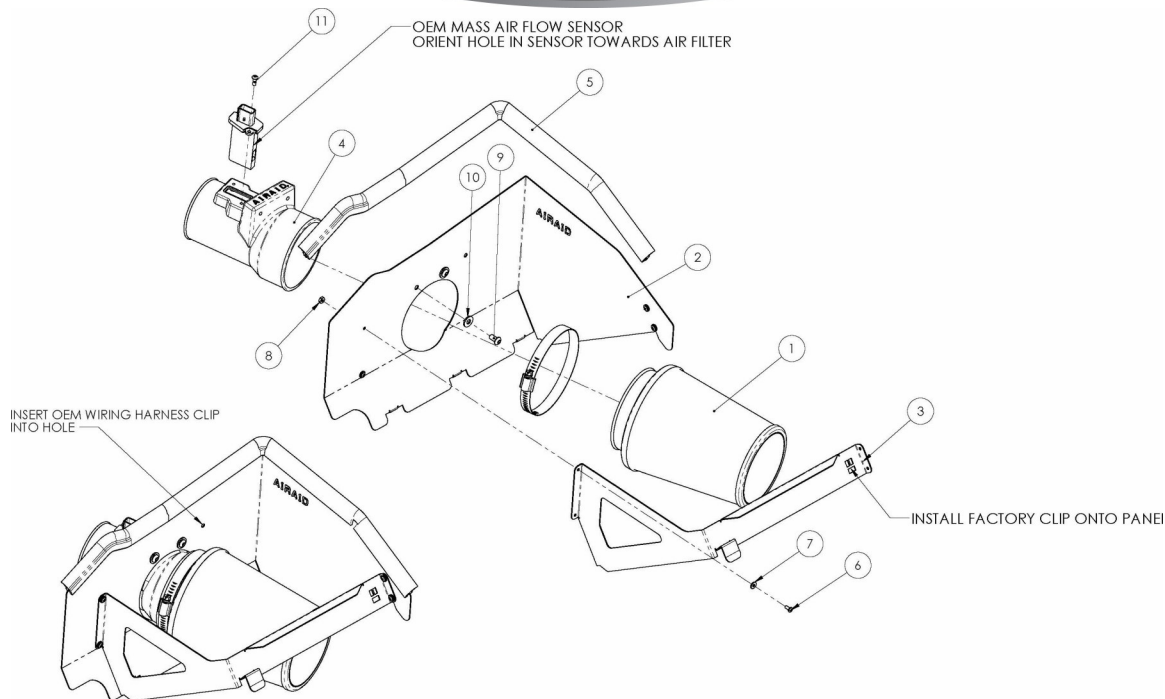

Full color instructions can be viewed on our web site at Airaid.com. Use the **Product Search** function to find your part number, and click **View Details**.



1. Disconnect the negative battery cable.

Loosen the hose clamp on the factory intake tube. Disconnect the Mass Air Flow (MAF) sensor wiring harness from the sensor, and unclip the harness from the air box lid.

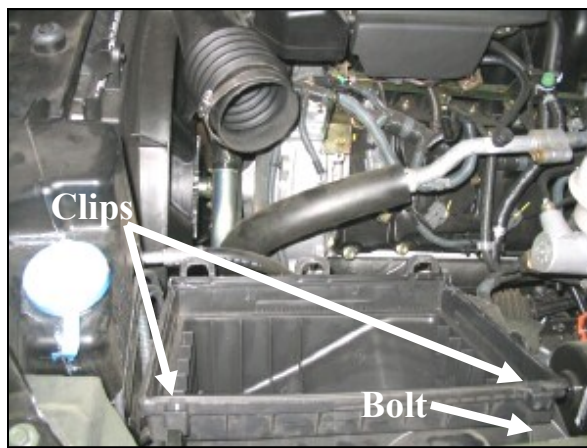

2. Unclip the factory air box lid from the factory air box base, and remove it from the engine compartment. Remove the factory air filter from the air box base. Using a 10mm socket, remove two bolts (three on some vehicles) from the air box base (save for reuse).



3. Using a Phillips head screwdriver, remove two screws and the MAF sensor from the factory air box lid. Save the sensor for reuse.

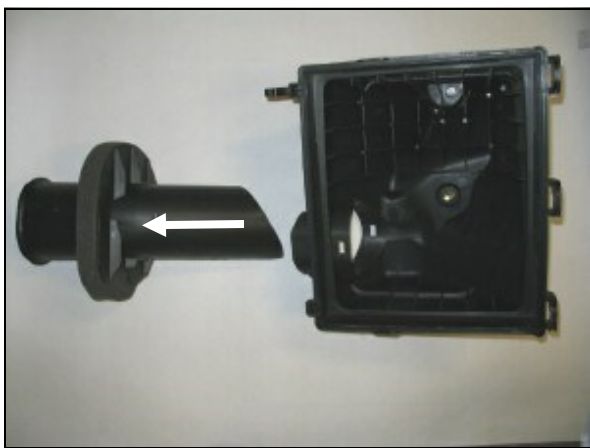

4. Remove the factory air box base from the vehicle. Using a flat blade screwdriver, unsnap and remove the factory tube from inside the air box base. Re-install the factory air box base and the bolts into the vehicle, without the tube.

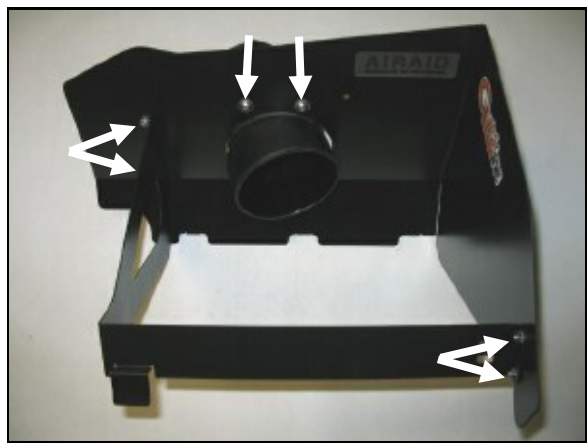

5. Assemble the Airaid Quick Fit Panels (#2, #3) using four 6-32 x 5/16" screws (#6), #6 flat washers (#7), and 6-32 keps nuts (#8). Next, install the air filter adapter (#4) using two 1/4-20 x 1/2" button head bolts (#9), and 1/4" flat washers (#10).

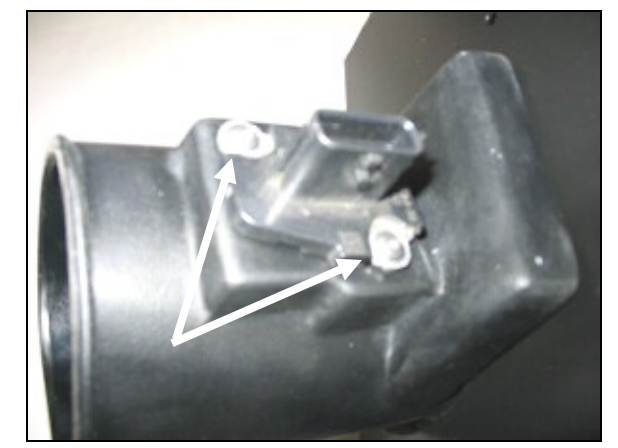

6. Using two 8-32 x 1/2" SS button head screws (#11), reinstall the factory MAF sensor into the air filter adapter.



7. Remove the clip from the factory air box lid and install it in the Quick Fit Panels as shown.



8. Install the Quick Fit Panel assembly onto the factory air box base using the factory clips. Slip the factory intake tube over the air filter adapter, and then tighten the factory hose clamp.



9. Reconnect the MAF sensor wiring harness to the sensor. Mount the factory wiring harness clip into the hole in the Airaid Quick Fit panel.



10. Install the Airaid Premium Filter (#1) onto the air filter adapter, and tighten the hose clamp. Install the weather strip (#5) onto the Quick Fit Panels as shown (*Note: Start at one corner and work your way around to the end to insure proper alignment of the weather strip*).

11. Double check your work!

Make sure there is no foreign material in the intake path. Make sure all clamps, hoses, bolts, and screws are tight.

12. Reconnect the negative battery cable!

Thank you for purchasing the Airaid Intake System. Contact Airaid @ (800) 498-6951 8:00 AM - 5:00 PM MST weekdays for questions regarding fit or instructions that are not clear to you. Your Airaid Intake System was carefully inspected and packaged. Check that no parts are missing, or were damaged during shipping. If any parts are missing, contact Airaid. The air filter element is protected from direct exposure to water and debris; care should be taken not to drive through deep water. **WATER INGESTION IS THE DRIVERS RESPONSIBILITY!** The air filter is reusable and should be cleaned periodically.

FILTER IDENTIFICATION

700-458 Airaid Oiled Media
702-458 Airaid SynthaMax Dry Media - Black

701-458 Airaid SynthaMax Dry Media - Red
703-458 Airaid SynthaMax Dry Media - Blue

For your Oiled media filter we suggest using the AIRAID Filter Tune-Up Kit!



**P/N 790-551 Aerosol Spray
P/N 790-550 Squeeze Spray**



Do Not Oil

Synthamax Air Filters do not require oil. Service air filter as needed by cleaning with common non-petroleum all-purpose household cleaner and water. Simple Green®, Formula 409® or equivalent works great. Apply cleaner to outside of air filter and allow to soak. Then flush filter clean from the inside out with a garden hose and repeat steps if necessary. Do not apply high pressure water or air to clean filter. Allow filter to air dry and reinstall.

