



Installation Instructions

For Part Number:

883-283 Snorkel Kit

**2008-14 Polaris Ranger RZR
800 E.F.I.**

NOTE: This is not a stand alone part. This snorkel tube is intended to be used in conjunction with Airaid Intake pn 883-282.

Tools Required For Installation:

7/16" Wrench, 7/16", Socket.
Ratchet & Extension. 5/32" Allen Wrench.
Locking Pliers. 1/8" and 5/15" Drill Bits. 3/8"
Hand Drill. Center Punch and Mallet. Locktite
® 242 or equivalent, and a roll of tape.

Thank you for purchasing the Airaid Intake System. Contact Airaid @ (800) 498-6951 8:00 AM - 5:00 PM MST weekdays for questions regarding fit or instructions that are not clear to you. Your Airaid Intake System was carefully inspected and packaged. Check that no parts are missing, or were damaged during shipping. If any parts are missing, contact Airaid. The air filter element is protected from direct exposure to water and debris; care should be taken not to drive through deep water. WATER INGESTION IS THE DRIVERS RESPONSIBILITY! The air filter is reusable and should be cleaned periodically.

Advisory Note:

Please read these installation instructions in their entirety before beginning the install process. Airaid strongly recommends the use of Locktite® 242 Medium strength threadlocker on all threaded fasteners.



1. Remove the Air Scoop assembly form the panel.

A.) Remove the Foam Pre Filter from the Air Scoop.
B.) Using a 7/16" wrench, remove all three sets of Nuts and Washers, from inside of the Scoop.
C.) Slide the Air Scoop and Gasket off of the mounting Studs and set aside.



2. Using a pair of Locking Pliers, remove the Threaded Studs from the riser tube. Take care not to damage the threads for future installations.

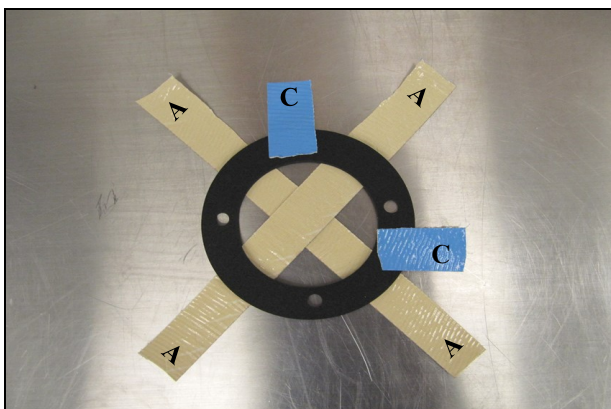

3. Prepare the Snorkel Tube Gasket (#6) to be used as a template.

A.) Lay two 8" strips of tape, adhesive side up, in a "X" pattern on a bench.
B.) Place the Gasket in the center of the X taking care not to block any bolt holes.
C.) Attach two 1" strips of tape, adhesive side down, on the Gasket in the 12 and 3 O'clock position.

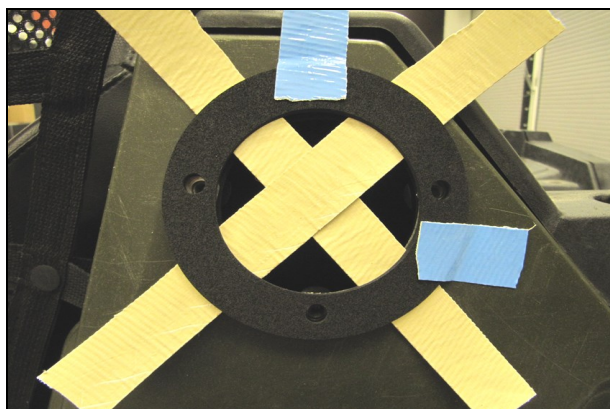

4. Carefully align the Gasket holes with the drilled holes in the panel and attach it using the two small strips of tape.

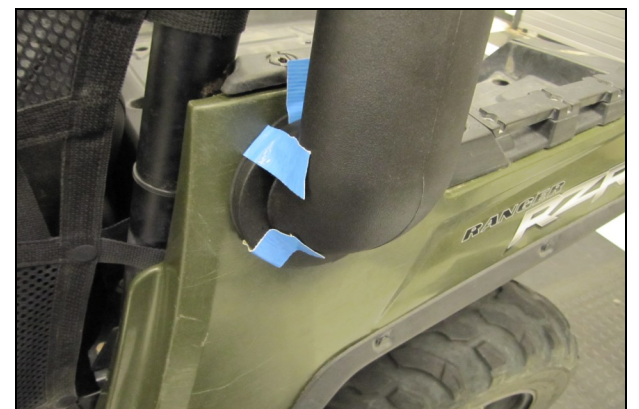

5. Determine the optimal position of the Snorkel Tube (#1) for your particular cage configuration. Hold the tube in place and fold the two 8" strips of tape over onto the Snorkel flange. Keep in mind that the Snorkel Tube will also need to be mounted to the cage for proper support.

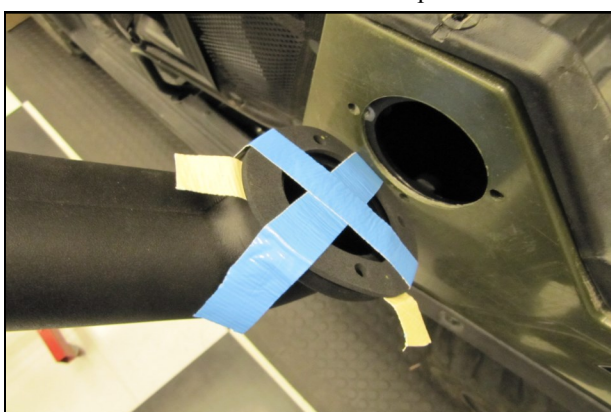

6. Carefully remove the Snorkel Tube with Gasket held in position by the tape.

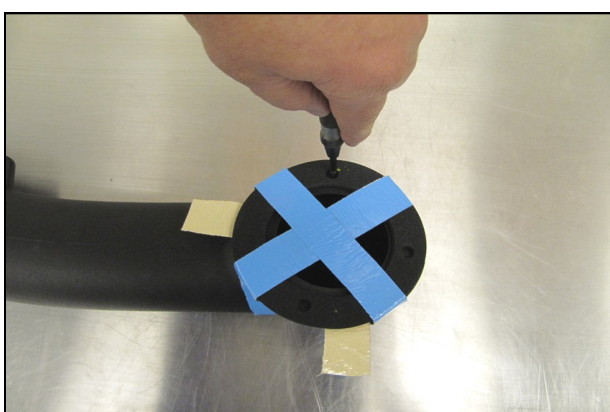

7. Mark the hole to be drilled with a center punch.



8. Remove the Gasket and drill the bolt holes in the Snorkel Flange. Start with 1/8" pilot holes and finish with 5/16" holes.

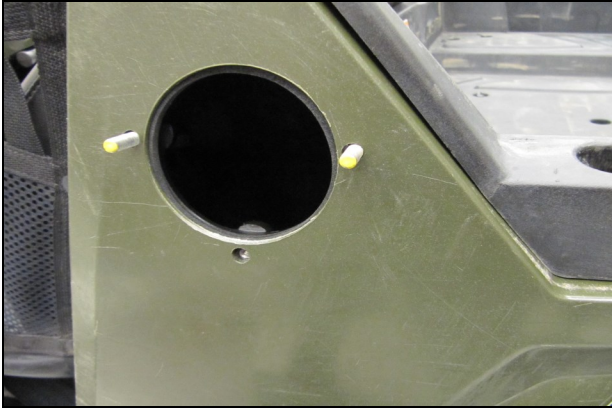

9. Temporarily re-install two of the Threaded Studs finger tight, into the Riser Tube as shown.

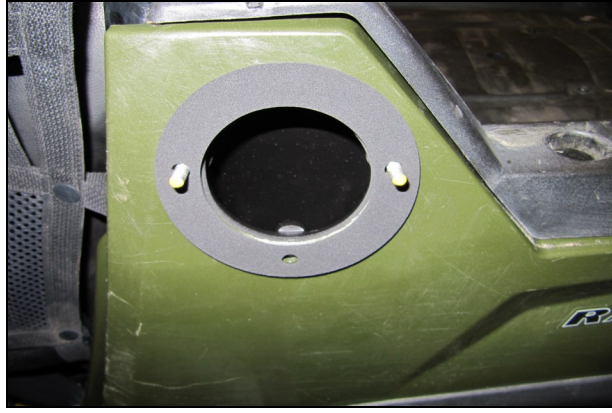

10. Slide the Snorkel Tube Gasket (#6) onto the Threaded Studs.



11. Mount the Snorkel tube on to the Threaded Studs and secure using one 1/4-20 x 1" Button Head Bolt (#2), 1/4" Lock Washer (#3), and 1/4" Flat Washer (#4). Do not fully tighten at this time.



12. Replace the Threaded Studs, one at a time, with the remaining 1/4-20 x 1" Button Head Bolts and 1/4" Washers from the previous step. Make all three Bolts final tight.

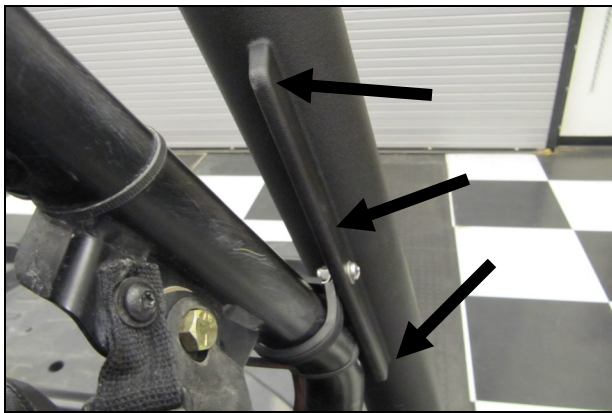

13. The Snorkel Tube has a large mounting tab to accommodate many cage options. Determine the best location for attachment and drill a 5/16" hole. Use the supplied Loop Clamp (#7) and the remaining 1/4-20 hardware (#2,3 & #4) to secure the Snorkel Tube.



14. **Double check your work!** Make sure there is no foreign material in the intake path. Make sure all clamps, hoses, bolts, and screws are tight.

DO NOT OPERATE VEHICLE WITHOUT SOME FORM OF CAGE MOUNTING!

883-283

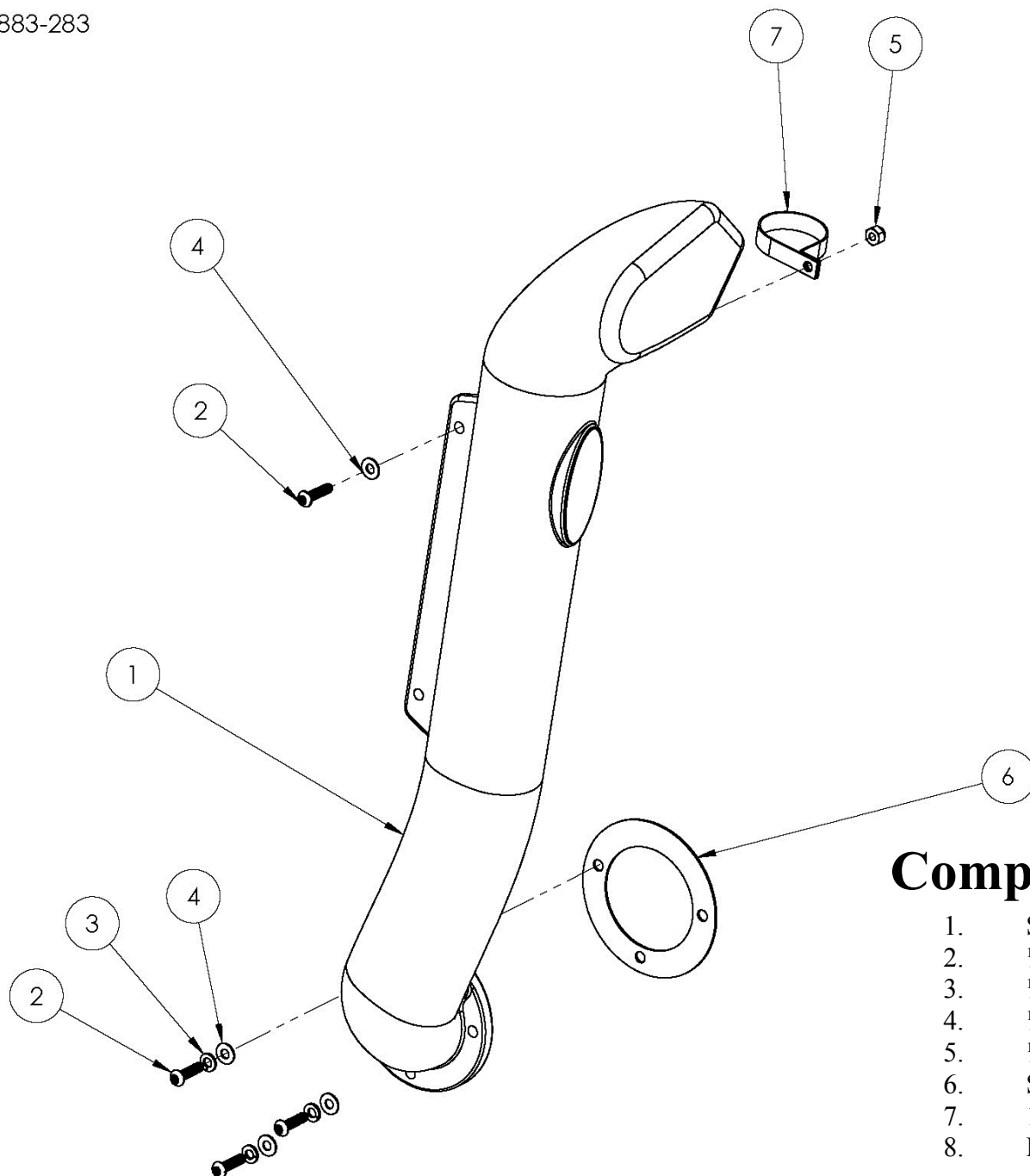

Component Identification

1.	Snorkel Tube	1
2.	1/4"-20 x 1" Button Head Screw	4
3.	1/4" Lock Washer	3
4.	1/4" Flat Washer	4
5.	1/4" Lock Nut	1
6.	Snorkel Tube Gasket	1
7.	1 3/4" Loop Clamp	1
8.	Bubble Sticker	1