

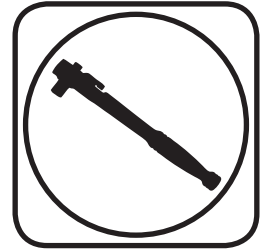

Part # 11243001 - 68-72 GM A-Body Front HQ Series Shockwave

Recommended Tools

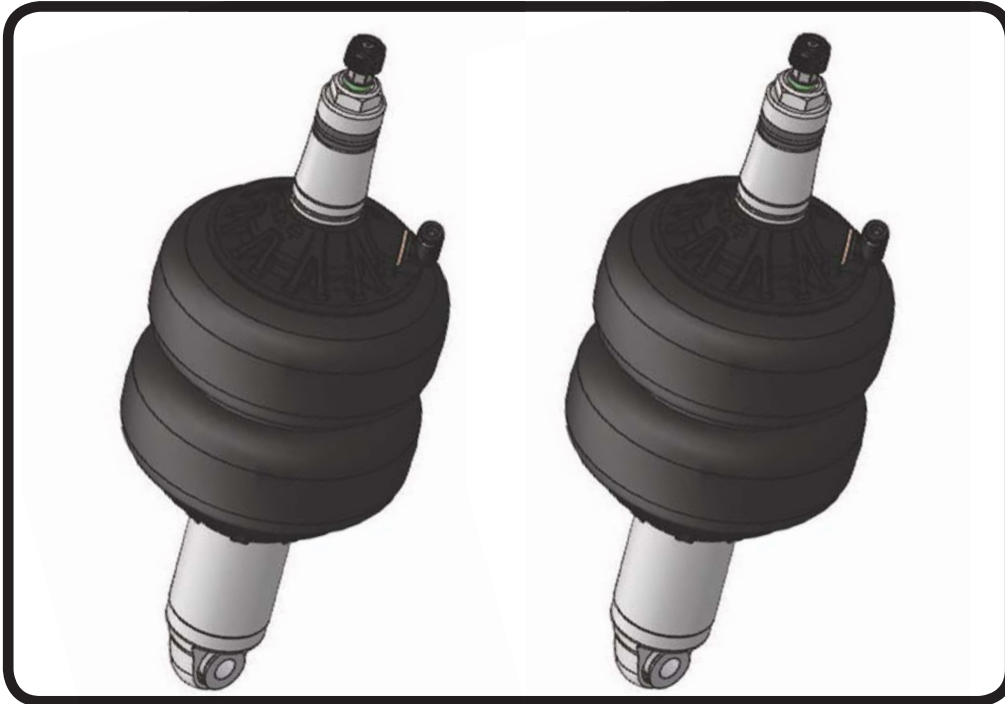

1000 Series Bellow, 2.00" Stud/Eye 3.6" Shock Installation Instructions

Table of contents

Page 2..... Included components

Page 3-4..... Shockwave Installation

Page 5-6..... Notes and Care of Your Shockwave & Shock Adjustment

ShockWave Dimensions:

Center of bearing to Center of bearing:

Compressed: 10.30"

Ride Height: 12.13"

Extended: 13.32"

THE DELRIN BALL REQUIRES A 3/4" HOLE FOR THE FLANGE TO GO THROUGH. THIS CAN BE DRILLED WITH A UNIBIT.

www.ridetech.com
812-482-2932





Major ComponentsIn the box

Item #	Part #	Description	QTY
1	24139999	3.6" Stroke HQ Series Shock	2
2	90009988	2.00" Stud Top (Installed on Shock) - Includes Adjuster Knob & Screw	2
3	24090199	1000 Series 6.5" Double Convoluted AirSpring	2
4	70010893	AirSpring Locking Ring (Installed on shock)	2
5	99055000	Locking Ring Set Screw (Installed on shock)	2
6	90002062	Spacers - INCLUDED WITH STRONGARMS	4
7	90002312	2.00" Aluminum Stud Top Base	2
8	90001904	Bottom Delrin Ball	2
9	90001903	Top Delrin Ball	2
10	90001902	Delrin Ball Aluminum Top Cap	2
11	99562003	9/16" -18 Thin Nylok Nut	2
12	90009972	Adjuster Knob - (90009988 assembly)	2
13	90009969	#4-40 X 1/4" SS, 18-8 Pan Head Torx Cap - (90009988 assembly)	2
	70012160	2.00" Stud Top Metering Rod (installed in stud top)	2
	90001994	5/8" ID Bearing (installed in shock and eyelet)	4
	90001995	Bearing Snap Ring (installed in shock and eyelet)	8

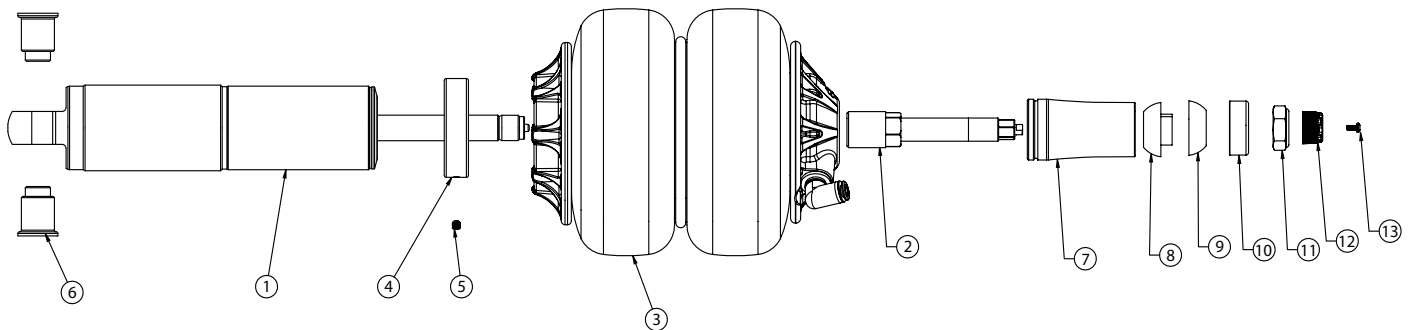

THE DELRIN BALL REQUIRES A 3/4" HOLE FOR THE FLANGE TO GO THROUGH. THIS CAN BE DRILLED WITH A UNIBIT.

WARNING: ATTEMPTING TO REMOVE THE AIR FITTING WILL DAMAGE IT AND VOID THE WARRANTY.



ShockWave Installation

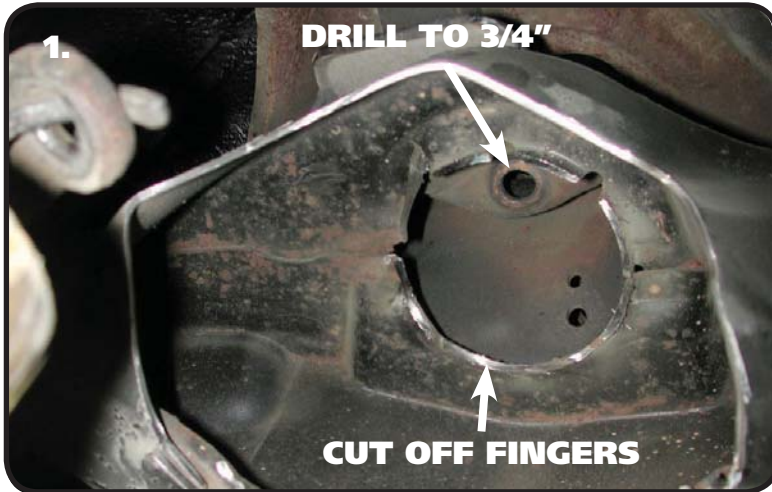

1. Drill the OEM shock hole out to 3/4". This can be done with a Unibit. The Shockwave top can come in contact with the coil spring retaining fingers. Test fit the ShockWave to determine if they need cut off. A die grinder works well here.



2. Some trimming must also be done on the outside of the frame pocket to allow clearance for the Shockwave.



3. To allow clearance for the Shockwave, some trimming must be done on the inside of the coil spring pocket as shown by the white line in the picture. This is best done with either a cut off wheel or plasma cutter. Grind all cuts smooth when finished.

Note: It may be helpful to go ahead and install the lower StrongArms and Shockwaves to determine exactly what needs to be removed.



ShockWave Installation

4.

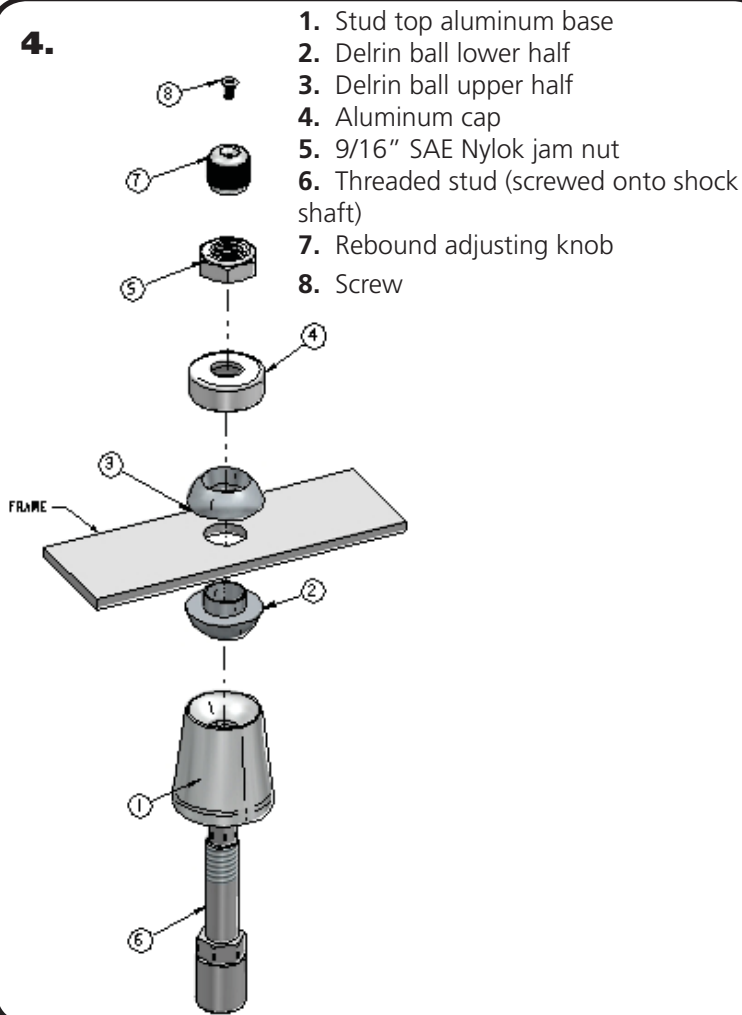

1. Stud top aluminum base
2. Delrin ball lower half
3. Delrin ball upper half
4. Aluminum cap
5. 9/16" SAE Nylok jam nut
6. Threaded stud (screwed onto shock shaft)
7. Rebound adjusting knob
8. Screw

Note: The airline must also be routed at this time. It can be ran through the subframe toward the rear of the vehicle.

4. The air fitting location can be rotated by twisting the bellow assembly separate of the shock. Place the Shockwave into the coil spring pocket with the stud sticking through the OEM shock hole. See assembly **Diagram 4**. OEM Shock hole **must** be drilled out to $\frac{3}{4}$ "

1. Stud top aluminum base
2. Delrin ball lower half
3. Delrin ball upper half
4. Aluminum cap
5. 9/16" SAE Nylok jam nut
6. Threaded stud (screwed onto shock shaft)
7. Rebound adjusting knob
8. Screw

5.

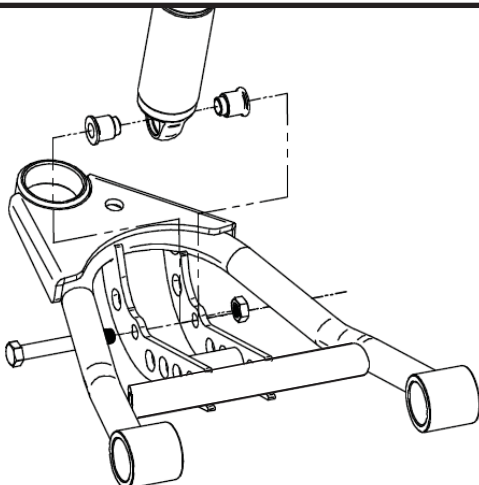

5. Raise the lower arm up to the Shockwave and bolt them together using the $\frac{1}{2}$ " x $3\frac{1}{4}$ " bolt and Nylok supplied w/ the lower arms. An aluminum spacer will be on each side of the bearing. Torque to 75 ftbs.

6. Raise the lower control arm to full compression and double-check to make sure the Shockwave does not rub on anything at any-time. Allowing the Shockwave to rub on anything will cause failure and is not a warrantable situation.

7. The best ride quality will occur around 50-60% suspension travel; depending on vehicle weight this typically occurs around 85-100 psi.



Notes and Care of your Shockwaves

NOTES:

WARNING: ATTEMPTING TO REMOVE THE AIR FITTING WILL DAMAGE IT AND VOID THE WARRANTY.

TIGHTENING THE TOP 9/16"-18 NUT: SNUG THE NUT DOWN AGAINST THE TOP CAP. YOU NEED TO BE ABLE TO ARTICULATE THE SHOCK BY HAND.

You can clock the airfitting location on the ShockWave by turning the AirSpring assembly of the shock. Make sure the fitting doesn't contact the frame.

When cutting the airline, use a razor blade. The cut needs to be a clean cut and square for the airline to seal properly.

The Locking ring on the shock is **NOT** adjustable. These rings are set at the factory to optimize the AirSpring stroke with the shock stroke.

The care and feeding of your new ShockWaves

1. Although the ShockWave has an internal bumpstop, **DO NOT DRIVE THE VEHICLE DEFLATED RESTING ON THIS BUMPSTOP. DAMAGE WILL RESULT.** The internal bumpstop will be damaged, the shock bushings will be damaged, and the vehicle shock mounting points may be damaged to the point of failure. This is a non warrantable situation.
2. Do not drive the vehicle overinflated or "topped out". Over a period of time the shock valving will be damaged, possibly to the point of failure. This is a non warrantable situation! If you need to raise your vehicle higher than the ShockWave allows, you will need a longer unit.
3. The ShockWave is designed to give a great ride quality and to raise and lower the vehicle. **IT IS NOT MADE TO HOP OR JUMP!** If you want to hop or jump, hydraulics are a better choice. This abuse will result in bent piston rods, broken shock mounts, and destroyed bushings. This is a non warrantable situation.
4. Do not let the ShockWave bellows rub on anything. Failure will result. This is a non warrantable situation.
5. The ShockWave product has been field tested on numerous vehicles as well as subjected to many different stress tests to ensure that there are no leakage or durability problems. Failures have been nearly nonexistent unless abused as described above. If the Shockwave units are installed properly and are not abused, they will last many, many years. ShockWave units that are returned with broken mounts, bent piston rods, destroyed bumpstops or bushings, or abrasions on the bellows will not be warrantied.



Shock Adjustment

Shock adjustment 101- Single Adjustable

Rebound Adjustment:

How to adjust your new shocks.

The rebound adjustment knob is located on the top of the shock absorber protruding from the eyelet.

You must first begin at the ZERO setting, then set the shock to a soft setting of 20.



-Begin with the shocks adjusted to the ZERO rebound position (full stiff). Do this by rotating the rebound adjuster knob clockwise until it stops.



-Now turn the rebound adjuster knob counter clock wise 20 clicks. This sets the shock at 20. (settings 21-24 are typically too soft for street use).

Take the vehicle for a test drive.



-if you are satisfied with the ride quality, do not do anything, you are set!

-if the ride quality is too soft increase the damping effect by rotating the rebound knob clock wise 3 clicks. **CONTINUE ON NEXT PAGE.**

Take the vehicle for another test drive.



-if the vehicle is too soft increase the damping effect by rotating the rebound knob clock wise 3 additional clicks.



-If the vehicle is too stiff rotate the rebound adjustment knob counter clock wise 2 clicks and you are set!

Take the vehicle for another test drive and repeat the above steps until the ride quality is satisfactory.

Note:

One end of the vehicle will likely reach the desired setting before the other end. If this happens stop adjusting the satisfied end and keep adjusting the unsatisfied end until the overall ride quality is satisfactory.

STILL HAVE QUESTIONS?

Tech line hours

Monday - Friday

8AM - 6PM (EST) 812-482-2932