

Installation Guide & Operation Manual

RidePRO
Pressure-based
Air Suspension Control

RidePROHP
Pressure & Height
Air Suspension Control

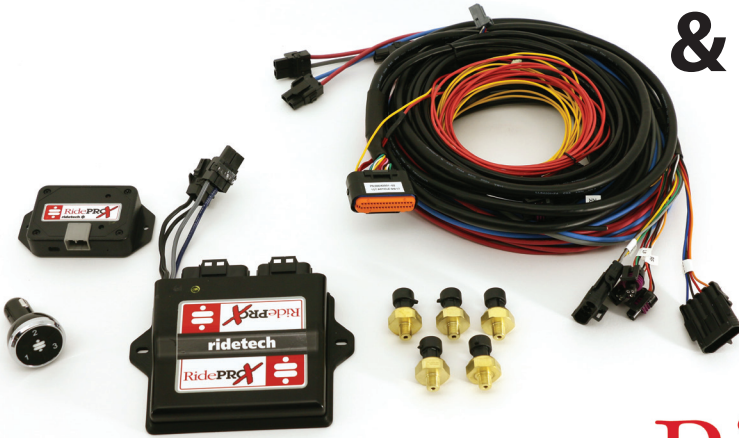

Thank you for choosing a RideTech air suspension control system. We are committed to providing the best experience possible throughout the process of getting your car on air.

Our commitment doesn't end with your purchase, in fact, it has only begun. This guide should provide you with the information you need to properly install and set-up your suspension control system.

However, if you find yourself having difficulty or if you have a question that isn't covered in this book, please call our tech department.

Tech Line: 812-481-4969

In addition to phone support, our web site also provides a wealth of helpful product / install / set-up information.

Contents

Component Installation

| | |
|------------------------------------|---|
| Mounting compressor | 2 |
| Mounting tank | 2 |
| Mounting air valves | 2 |
| Routing air lines & fittings | 3 |
| Mounting pressure sensors..... | 3 |
| Mounting the controls & ECU..... | 3 |
| Wiring..... | 3 |

RidePRO-HP Installation

| | |
|--|---|
| Installing external ride height sensors..... | 4 |
| Sensor Rod Assembly..... | 5 |
| Example installations | 5 |

AirPod™ Installation

| | |
|-------------------------|---|
| Mounting the unit | 6 |
| Wiring..... | 6 |

| | |
|------------------------------|---|
| System Control Options | 7 |
|------------------------------|---|

Mobile App

| | |
|--|---|
| Installing Mobile App & Linking iPhone..... | 8 |
| Installing Mobile App & Linking Android..... | 9 |

| | |
|-----------------------------|-------|
| Mobile App Users Guide..... | 10-15 |
|-----------------------------|-------|

| | |
|-------------------|----|
| Calibration | 16 |
|-------------------|----|

| | |
|-----------------------------|-------|
| Troubleshooting guide | 17-18 |
|-----------------------------|-------|

| | |
|------------------------|----|
| Plumbing Diagrams..... | 19 |
|------------------------|----|

| | |
|-----------------------|------------|
| Wiring Diagrams | back cover |
|-----------------------|------------|



Installing a RidePRO System

STOP Remove the negative battery cable before beginning installation.



Mounting the Compressor

- All of our compressors are sealed for moisture and dust resistance so they can be mounted anywhere on the vehicle, though it is best to mount it in a place out of direct contact with rain and snow. It is OK to mount it underneath the vehicle, but keep it inside the frame rails away from water and debris thrown off the tire.
- This is a dry compressor; therefore it is maintenance-free and can be mounted in any position.
- It is best if mounted to something solid to reduce vibration and noise. If mounting it to sheet metal or the bed of a truck, use sound-deadening material between the compressor and the mounting surface.
- Use the rubber grommets supplied on the feet of the compressor to reduce vibration.
- Attach the grey wire from the main power harness to the black wire on the primary compressor. The red wire connects to +12V.
- Thomas Compressors (black) will require a 20 amp fuse (each).

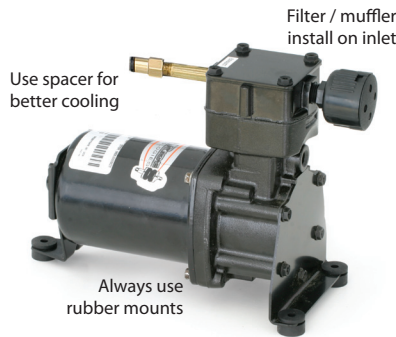

Mounting the Air Tank

- The air tank can be mounted anywhere on the vehicle in any position, So long as the sensor is not pointed down.
- There is an 1/8" port in the tank that will accept the tank pressure sensor.

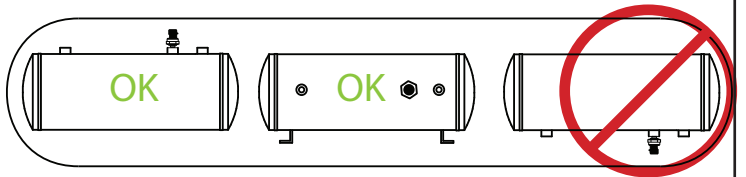

Mounting the RidePro Air Valves

- The valves, like the compressor, are sealed and can be mounted in the same locations. Although, if the vehicle will be exposed to freezing temperatures, it is a good idea to mount them in the engine bay if possible to reduce the possibility of freezing.
- They can be mounted in any position.
- Attach the ground strap to a good, clean ground (preferably the frame).
- The exhaust port will be left open.
- The valve is held closed with the pressure in the tank. If tank pressure drops below air spring pressure they will equalize, deflating all 4 air springs.

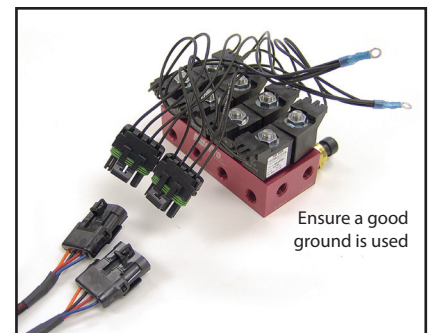

IF YOU ARE RUNNING A 2 COMPRESSOR SYSTEM, THE 2ND COMPRESSOR WILL NEED TO BE TURNED ON IN THE SETUP MENU! PAGE 11 WILL SHOW YOU WHERE TO TURN IT ON. YOU MAY GET ERROR #143 BEFORE YOU TURN COMPRESSOR #2 ON. IF YOU GET THIS ERROR, GO TO THE SETUP MENU AND TURN COMPRESSOR #2 ON. THE ERROR WILL CLEAR AFTER THE IGNITION IS CYCLED.

NOTE:

The RidePRO system switches ground on the compressors; the compressors are provided power at all times.

IF YOU ARE RUNNING A 2 COMPRESSOR SYSTEM, THE 2ND COMPRESSOR WILL NEED TO BE TURNED ON IN THE SETUP MENU! PAGE 11 WILL SHOW YOU WHERE TO TURN IT ON.

Installing a RidePRO System

Routing the Airline and Fittings

- Make all airline cuts with a razor or tubing cutter (part # - 90001081). The cut must be clean and straight or it will not seal.
- All fittings are DOT approved push-to-connect style. They are very simple to use and are reusable. Firmly push the airline into the fitting to attach. To release the airline push the collar on the fitting back towards the fitting and pull the airline out.
- **Use thread sealant on all fittings. The white compound that is on the fittings is an anti-gauling compound.**
- Do not over-tighten the fittings. This could result in breaking the fitting or damaging the air spring.
- All of our airlines are DOT approved so they are very strong, but keep them away from any sharp edges. Also, when passing through a hole in the frame use a grommet.
- Keep away from intense heat, including mufflers and exhaust manifolds.
- Use zip ties or other fasteners to secure the airline.

Use Tubing Cutter (part # 90001081) for straight ends.

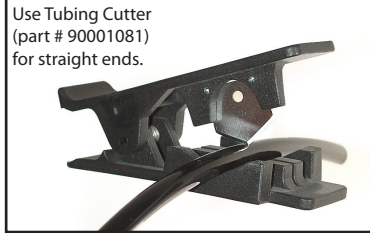

Mounting the Air Pressure Sensors

- These sensors are voltage based and do not need to be grounded.
- Use thread sealant when installing pressure sensors in valve block.
- Sensors can not be pointed down (debris can collect and cause false readings)

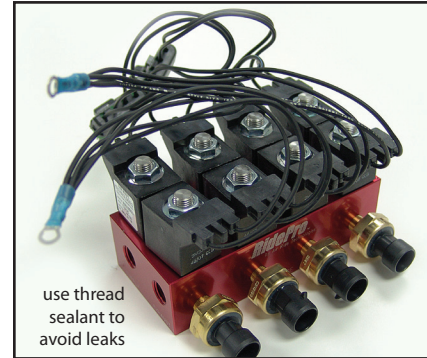

use thread sealant to avoid leaks

Mounting the ECU (Electronic Control Unit) & WCU (Wireless Control Unit)

- The ECU is water proof and may be mounted in the engine bay or under the vehicle.
- The WCU is **NOT** water proof and needs to be mounted inside the vehicle. It should be mounted in a location where it can be accessed with ease.
- The WCU is wireless device, do not mount it fully enclosed by metal. Doing so will reduce the wireless range.

Insert PPM (Power Port Module) into Power Port or Cigarette Lighter

- Make sure the Numbers are lit up.
- The PPM has a USB port in the side that can be used to charge your phone.



Ground Wires Compressor Control Wires



Main Harness Plug Level Sensor Plug



Black wire
A clean chassis ground

Yellow wire
Ignition
(12 volts only when the key is on)

Red wire
Constant 12 volt

Grey Wire
Primary Compressor Ground

Blue Wire
Secondary Compressor Ground (OPTIONAL)

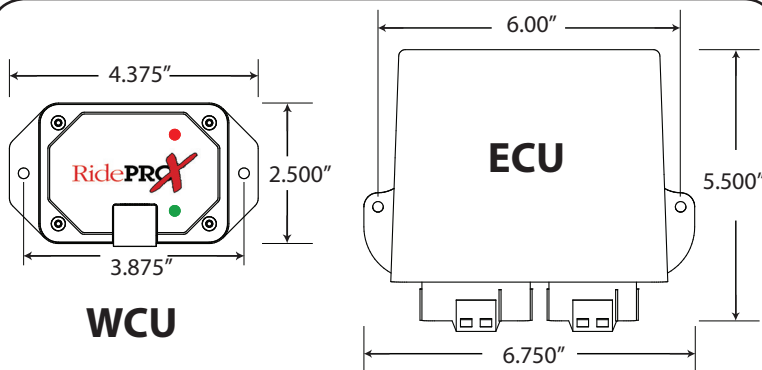

Main Harness



Tank Pressure Sensor Harness



Pressure Sensors



Power Port Module



Height Sensors & Harnesses



External RidePRO-HP Sensor Installation

- The RidePRO-HP system uses 4 height sensors (one at each wheel). They are weather proof and may be mounted in any position as well as "clocked" in any position. (There is not a difference between the left and right sensors.) These sensors are typically mounted to the chassis / frame rail.
- A linkage with rubber ends connects the sensor arm and a suspension component. On most front suspensions, the linkage will attach to the upper or lower control arm. On most rear suspensions, it will attach to the axle or control arm.
- **The main goal when mounting the sensor is to achieve as much sensor rotation as possible without exceeding the sensors limits.**
- Although the sensor arm will rotate 180 degrees, it must remain in the middle 90 degrees throughout suspension travel. See diagram below for sensor travel limits.
- It may be necessary to shorten the sensor arm and drill a new hole to ensure the arm is rotating enough during suspension travel to accurately determine vehicle height.
- The sensor arm can also be removed from the sensor and clocked in four different positions. It may also be necessary to bend the sensor arm and/or linkage to achieve proper clearance and alignment.
- The sensor will be mounted to the frame using 1/4" self tapping screws or bolts. A special shouldered bolt is supplied to attach the rubber rod ends to the suspension and the sensor arm; this will avoid over tightening.
- Make sure the sensor has adequate clearance from all suspension components throughout suspension travel. Check tire clearance, lock to lock and throughout suspension travel.

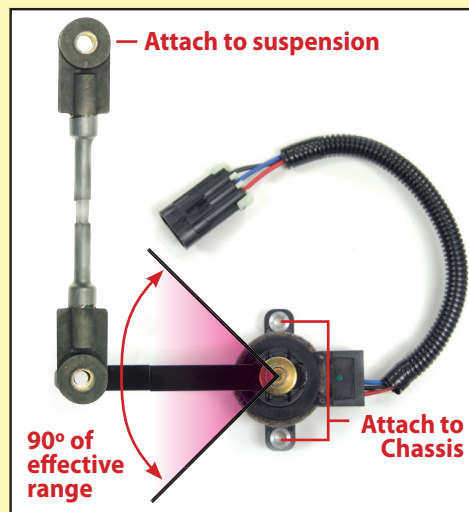

Travel Limits

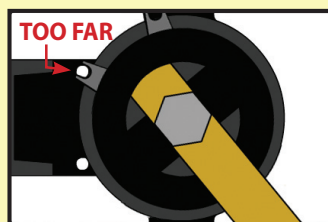
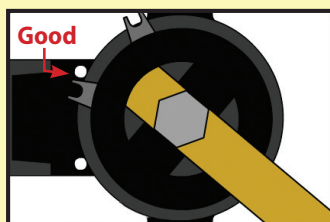
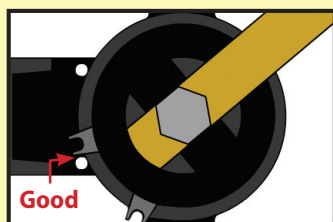

- ⚠ If the electrical range of travel is exceeded, the system may function erratically or not at all.
- ⚠ Also note that if the sensor has very little travel, the system may not perform to its potential.
- ⚠ It may be necessary to shorten the sensor arm to increase travel.

Assembly of the Sensor Link Rods



1- Once the linkage rod has been cut to the proper length, assemble the linkage rod with heat shrink tubing and the rubber end.



2- Slide the heat shrink tubing over the rubber end as far as it will go.

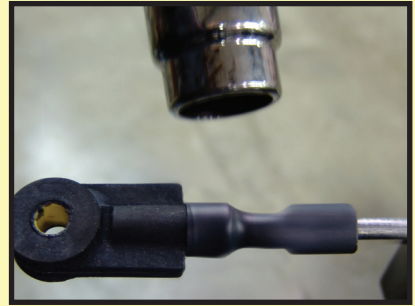

3- Heat the shrink tubing with a heat gun (hair dryer or small torch will work). **Begin by heating the rubber end first.** The heat shrink is lined with adhesive and will stick to the rubber when heat is applied.



4- Continue shrinking the tube to the rod until secured. Be sure not to overheat the tubing causing it to pull from the rubber end.

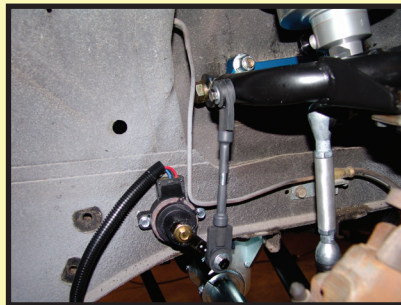

5- Once both sides of the linkage have been finished, secure the linkage to the sensor and suspension.

Sensor Mounting Examples



69 Camaro Front



Rear Trailing Arm



58-64 Impala Front

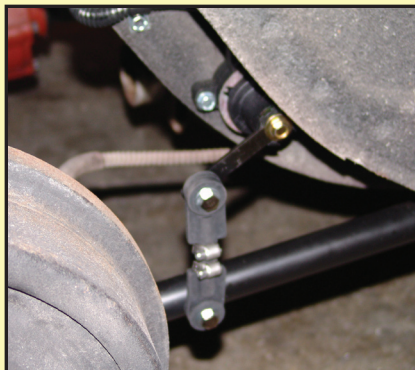

65-70 Mustang Rear



Triangulated 4-Link Rear

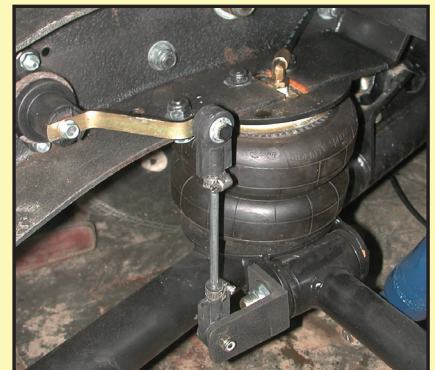

C-10 Truck Rear



Installing an AirPod

STOP Remove the negative battery cable before beginning installation.

MOUNT THE MAIN UNIT:

- 1- Mount the base flat to the vehicle surface (do not bend the base)
- 2- Secure the base with self-tapping screws or bolts.
- 3 - If optional cover is used, secure the cover to the airpod base using the supplied screws.

CONNECT AIR LINES:

- 1 - Airline cuts must be straight and clean - use a razor blade or tubing cutter. (part # - 90001081)
- 2 - All fittings are DOT-approved, reusable, push-to-connect style. Firmly push the airline into the fitting to attach. To release the airline, push the collar on the fitting back towards the fitting and pull the airline out.
- 3 - All of our airlines are DOT-approved so they are very strong. Secure the airline with zip ties, keep them away from any sharp edges, and when passing through a hole in the frame, use a grommet.
- 4 - Keep away from intense heat including mufflers and exhaust manifolds.

WIRELESS CONTROL UNIT WCU:

- 1- The Wireless Control Unit (WCU) must be mounted in a dry location where it can be accessed with ease.
- 2- Connect the supplied cable to the WCU and AirPod.



Required airline hookup.



RF LF RR LR

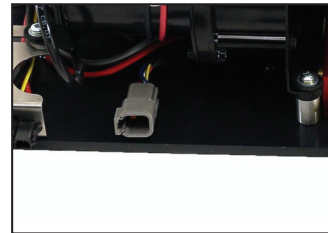

CONNECT POWER HARNESS:

- 1 - Connect the red power wire directly to the battery. Use included fuse within 18" of battery.
- 2 - Connect the yellow ignition wire to switched 12v. (Fuse Panel is the best location)
- 3 - Connect the black wire to chassis ground.

Be sure to use included fuse holder in the battery feed wire as close to the battery as possible.

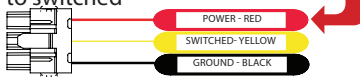

CAUTION: Use 8 gauge wire or larger to extend red power feed if needed



CONNECT RIDEPRO-HP SENSORS (if equipped):

See RidePro-HP section for more information on installing and calibrating height sensors.

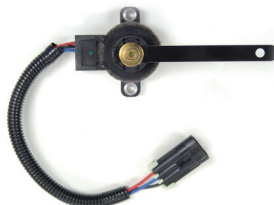

RidePRO X System Control Options

IF YOU ARE RUNNING A 2 COMPRESSOR SYSTEM, THE 2ND COMPRESSOR WILL NEED TO BE TURNED ON IN THE SETUP MENU! PAGE 11 WILL SHOW YOU WHERE TO TURN IT ON. YOU MAY GET ERROR #143 BEFORE YOU TURN COMPRESSOR #2 ON. IF YOU GET THIS ERROR, GO TO THE SETUP MENU AND TURN COMPRESSOR #2 ON. THE ERROR WILL CLEAR AFTER THE IGNITION IS CYCLED.

System Control

This system can be controlled 5 ways; PPM, Mobile App, Laptop, optional Keyfob Remotes, or optional dedicated mobile device. This section will cover all control options.

The RidePro X-HP will need to have gone through setup before the PPM or optional Keyfob Remotes will work.

PPM

- plugs into your vehicles Power Port (cigarette lighter)
- allows the user to select from any of the 3 presets
- works with the key on or off.
- built in USB port for charging devices
- can only be used after the control system has been through calibration and had the presets saved

Keyfob Remotes

- allows the user to select from any of the 3 presets
- works only with the ignition off
- can only be used after the control system has been through calibration and had the presets saved

Mobile App, Bluetooth Display, & Laptop

- system setup can be completed with any of the 3 devices
- 4 corner manual control at any time
- allows the user to select from any of the 3 presets
- system options can be changed
- pressure (RidePro X) and height sensor (RidePro HP) displayed
- tank pressured displayed
- system errors can be viewed
- works only with the ignition on

The system control is the same between the 3 devices with the only difference being the ability to link a smartphone to the WCU using a laptop.

Connecting a Laptop to the WCU

1. Download the Software at www.ridetech.com.
2. Turn the key on to power up the RidePro X-HP.
3. Use a USB to Mini-USB cord to connect the laptop to the WCU. The Mini-USB port is to the left of the wires harness plug of the WCU. The first time you plug into the WCU, device Driver software will be installed.
4. Open the Software, "Search for controller" will pop up. Select "Yes".
5. "E4 Found" will pop up, select "OK". This will take you to the Main Screen.

3.



4.

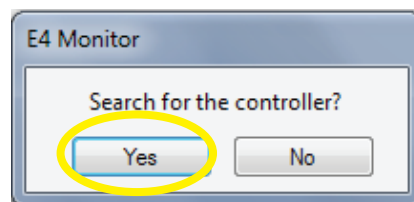

5.

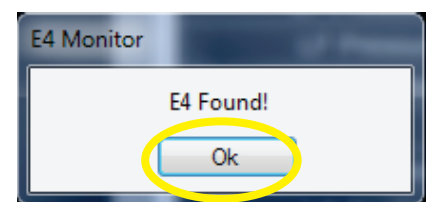

You will be able to use the Laptop to run your vehicle through calibration, learn the PPM, and change the setup settings. Pages 8-15 give an overview of using the Mobile App and Laptop Software. Don't forget we can learn a mobile device from here as well.

RidePRO~~X~~ Installing App & Linking iPhone

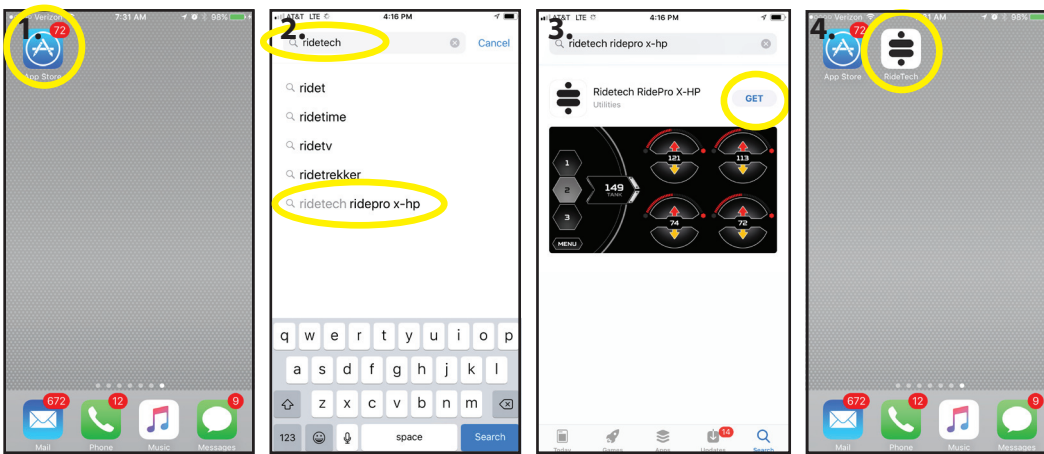

1. Select the **App Store** Icon on your screen.

2. Using the search feature, type in **ridetech**. There will be a list that pops up of different names, select the **ridetech ridepro x-hp**.

3. Touch the **GET** button to download the RidePro X-HP app to your phone.

4. After the App loads, open it by touching it on your screen.

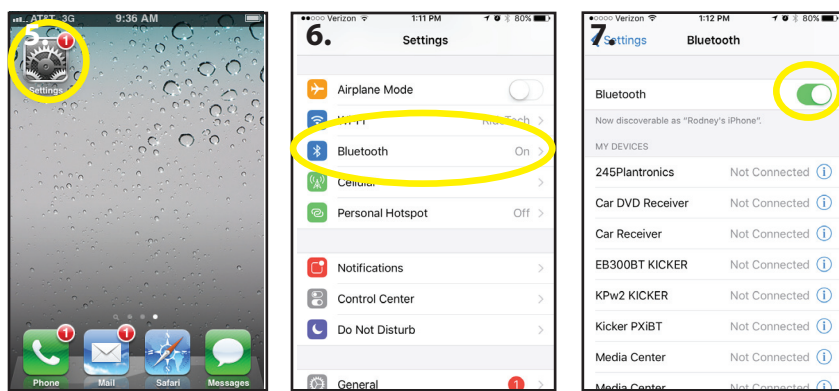

The RidePro X-HP needs to be installed and powered up to complete the following steps.

5. Select the **Settings** Icon on your phone screen.

6. Select **Bluetooth** from the settings menu.

7. Turn the Bluetooth On if it is off. The switch will be green. If it is not green, slide the switch to the right, turning it green.

8. Open the **RideTech** App on your phone.

9. The WCU has a Small Hole beside the plug. Find something small enough to fit the hole. We use a paperclip that has been straightened out.

10. Insert the paperclip straight in the hole. Push straight in until you feel a click through the paperclip. You do NOT need to use a lot of pressure to push the button. Excessive pressure will damage the unit. The Green Light on top of the ECU will start flashing rapidly. The green light will go solid when the unit is paired with your phone.

11. Touch the RTXXXXX number that is displayed on the "Available Devices" screen. This must be done while the Green light is flashing rapidly. Once it is linked, you will see the Main Screen.

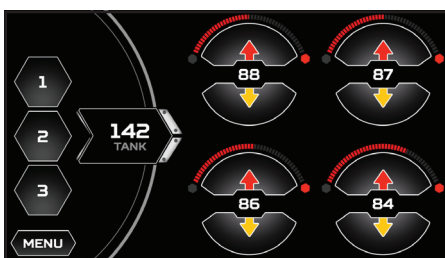
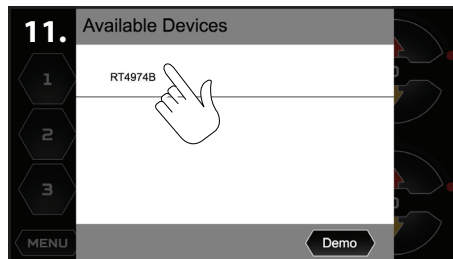
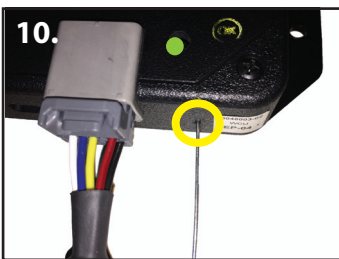
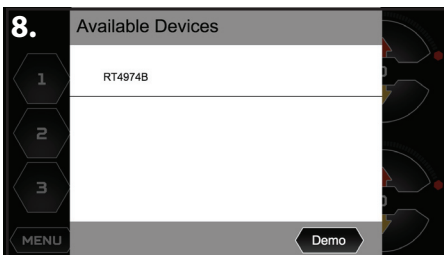

Demo

Demo Mode.

If the App is in Demo Mode, the Available Devices Screen will not show up when you open the app. You will know the App is in Demo Mode if all the numbers are counting up. You will need to stop the App to get it into pairing mode.

RidePRO ~~X~~ Installing App & Linking Android

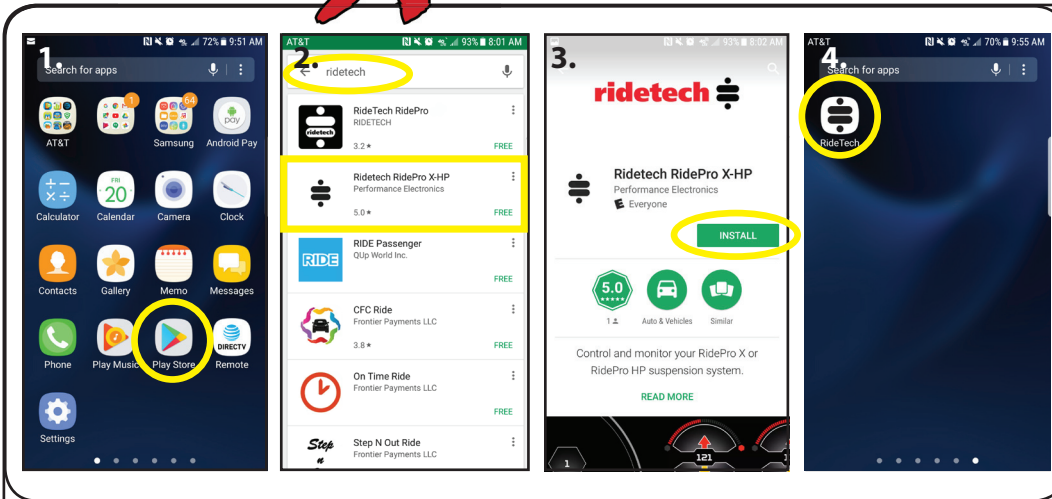

1. Select the **Play Store** Icon on your screen.

2. Using the search feature, type in **ridetech**. There will be a list that pops up of different names, select the **Ridetech RidePro X-HP**.

3. Touch the **INSTALL** button to download the RidePro X-HP app to your phone.

4. After the App loads, open it by touching it on your screen.

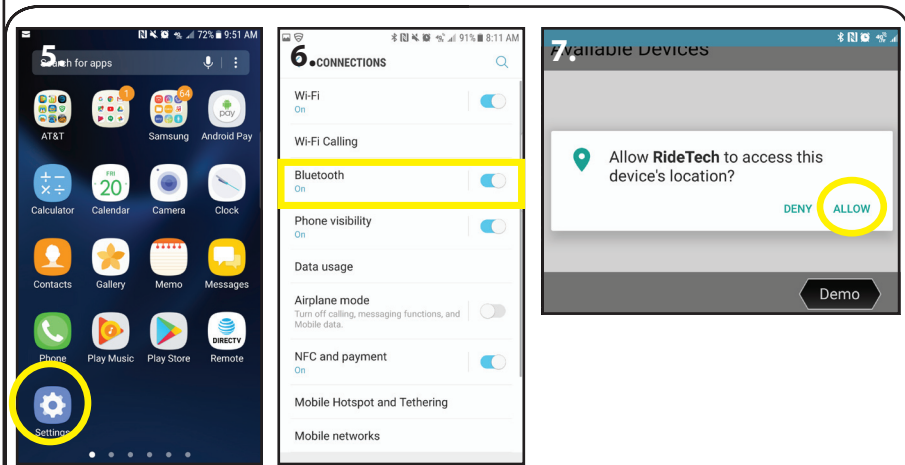

The RidePro X-HP needs to be installed and powered up to complete the following steps.

5. Select the **Settings** Icon on your phone screen.

6. Turn the Bluetooth On if it is off. The switch will be blue. If it is not blue, slide the switch to the right turning it blue.

7. Open the **RideTech** App on your phone. When you open the App for the first time "Allow RideTech to access this device's location" will pop up, select either choice. We do not monitor the device location.

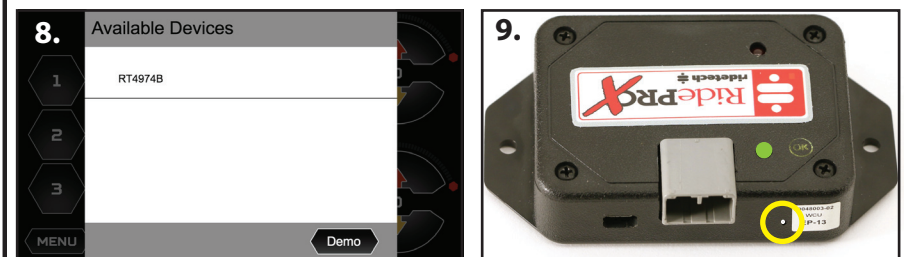

8. After making your choice for the Location Service, you should see **Image 8**. If you do not see it, make sure the WCU is plugged in and the system is turned on.

9. The WCU has a Small Hole beside the plug. Find something small enough to fit the hole. We use a paperclip that has been straightened out.

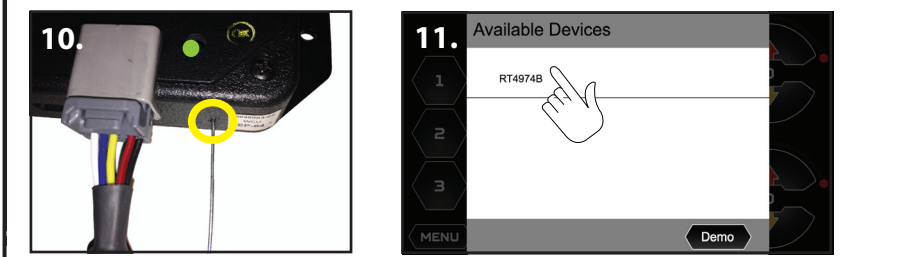

10. Insert the paperclip straight in the hole. Push straight in until you feel a click through the paperclip. You do NOT need to use a lot of pressure to push the button. Excessive pressure will damage the unit. The Green Light on top of the ECU will start flashing rapidly. The green light will go solid when the unit is paired with your phone.

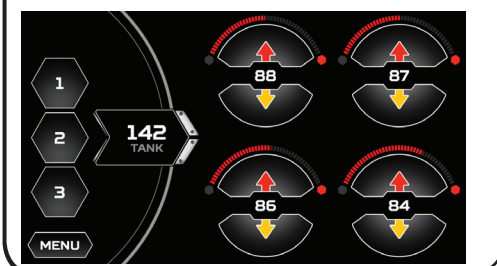

11. Touch the RTXXXXX number that is displayed. This must be done while the Green light is flashing rapidly. Once it is linked you, will see the Main Screen.

RidePRO X Mobile App & Laptop Users Guide

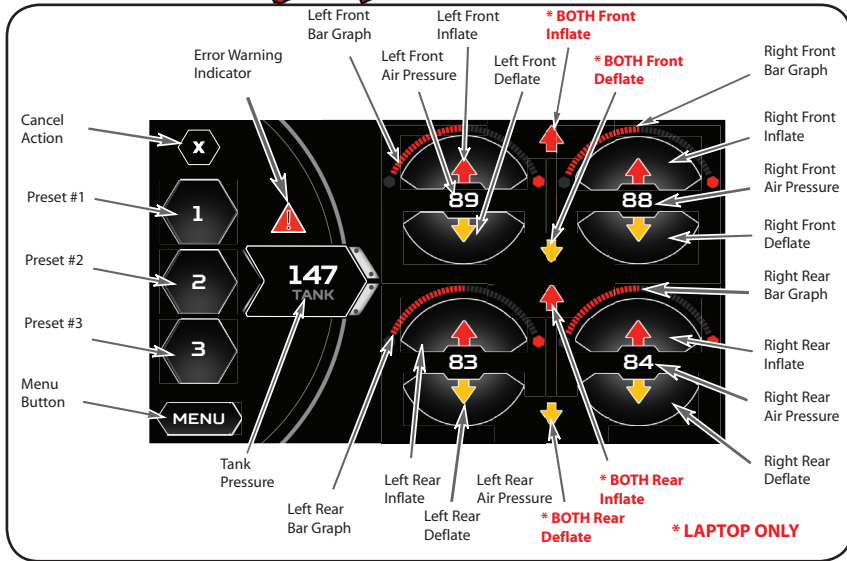

INFLATE & DEFLATE BUTTONS

You have full manual control at any time. To inflate an air spring simply press and hold the corresponding "▲" button. To deflate an air spring simply press and hold the corresponding "▼" button. The corresponding air spring will be inflated OR deflated until the button is released.

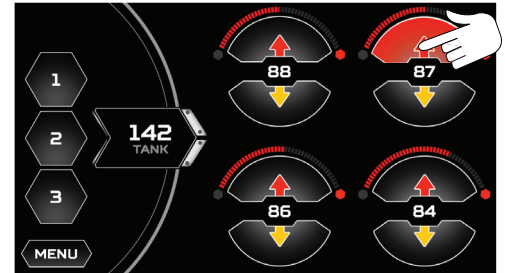

MAIN CONTROL SCREEN

The Main Control Screen displays information about the pneumatic suspension system including:

- individual pressure for each corner of the vehicle
- tank pressure
- preset indication
- bar graph for each corner. If the system is running in pressure only (RidePro X), the bar graph reflects the air pressure. If the system is equipped with ride height sensors (RidePro HP), the bar graphs reflect the ride height sensor position.

The Main Control screen also allows adjustment of the following:

- manual control of individual corner air pressure/vehicle height
- preset selection
- System parameters and additional information via the Menu system

MANUAL CONTROL

The user has full manual control of inflating and deflating the system at all times.

Press a Red up arrow button to inflate the corresponding corner.

Press a Yellow down arrow button to deflate the corresponding corner.

Multiple buttons can be pressed simultaneously on the Mobile APP. The laptop has a feature that allows both air springs to be inflated or deflated simultaneously.

Inflate and deflate buttons can be pressed simultaneously.

PRESETS

There are three user configurable Presets. The Presets can be saved to whatever vehicle height you wish. Typically Preset 1 is deflated vehicle height, Preset 2 is Ride Height, and Preset 3 is High Height.



Presets are disabled until Calibration has been successfully completed.

After Calibration, presets can be saved by manually inflating or deflating the vehicle to the desired height, then pressing and holding a preset button for 5 seconds. A dialog screen will be displayed stating which preset has been saved.

SETTING PRESETS

Use inflate and deflate buttons to obtain desired vehicle height. To store the height as a preset **press and hold the preset button for 5 seconds** or more. The screen will display "Preset # SET" when completed. Press the OK button to get back to the Home Screen.

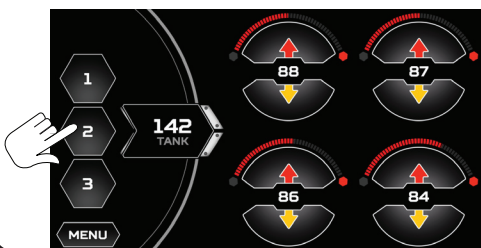

Press and hold for over 5 seconds to store current ride height as a preset

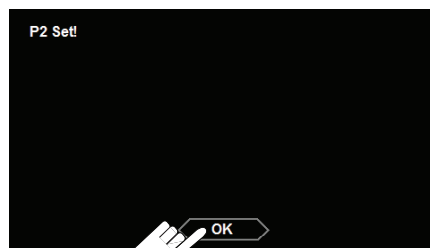

RidePRO Mobile App & Laptop Users Guide

MENU

The Menu provides the ability to adjust system parameters to meet individual's tastes, as well as displaying useful information.

One may exit the Menu at any time by pressing the "Home" button.

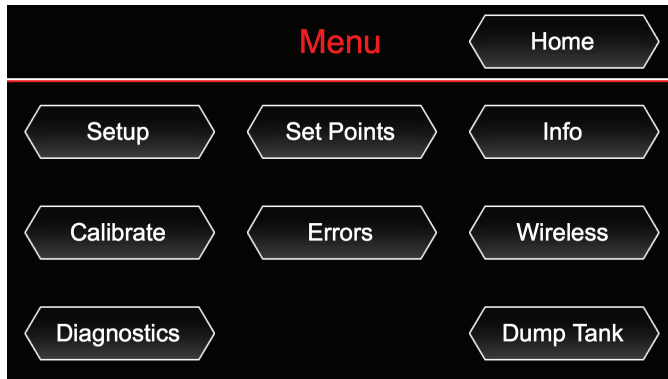

Setup

The Menu Setup screen contains the basic operating parameters of the system.

Go To P2 on Start:

By choosing Yes, the vehicle will return to Preset #2 whenever the ignition is cycled. This is typically used to set the vehicle back to Ride Height anytime the vehicle is started. **FACTORY DEFAULT IS "OFF".**

Use Primary Compressor:

Selecting Yes here enables control of the primary air compressor. **FACTORY DEFAULT IS "ON".**

Use Secondary Compressor:

Selecting Yes here enables control of the secondary air compressor. **FACTORY DEFAULT IS "OFF", IT WILL NEED TO BE SWITCHED TO "ON" IF YOU ARE RUNNING 2 COMPRESSORS! YOU MAY GET ERROR #143 BEFORE YOU TURN COMPRESSOR #2 ON. IF YOU GET THIS ERROR, GO TO THE SETUP MENU AND TURN COMPRESSOR #2 ON. THE ERROR WILL CLEAR AFTER THE IGNITION IS CYCLED.**

Compressor on PSI:

This allows one to select at what pressure the compressor will be turned on. By default, the system turns the compressor on when the tank pressure drops below 135psi. **FACTORY DEFAULT IS "135".**

System Accuracy:

This allows one to adjust how accurately the system reaches presets. Though High Accuracy will reach preset values extremely closely, it may take longer than one desires. In this case, one could choose Standard or Medium accuracy, which will allow the system to reach the preset destination quicker, but the physical height of the vehicle may be slightly off from the preset values.

By default, the system is set to Medium Accuracy.

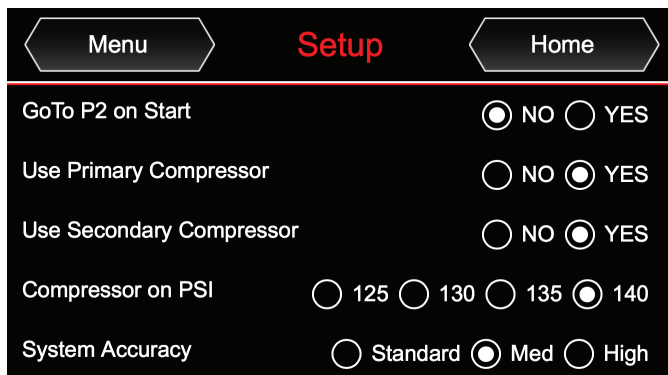

RidePRO X Mobile App & Laptop Users Guide

Set Points

The Menu Set Points screen displays the saved Preset set points of each corner of the vehicle, as well as the current values for each corner.

If the system is running in air pressure only mode (**RidePRO X**), it will automatically display pressure (psi).

If the system is running in air pressure and height sensor mode (**RidePRO HP**), it will automatically display level sensor voltage.

RidePRO X

| Menu | Setpoints | | | | Home |
|----------------|-----------|-----|-----|-----|------|
| Pressure (psi) | LF | RF | LR | RR | |
| P1 | 20 | 20 | 20 | 23 | |
| P2 | 88 | 86 | 82 | 82 | |
| P3 | 117 | 117 | 103 | 103 | |
| Current | 92 | 85 | 83 | 84 | |

RidePRO HP

| Menu | Setpoints | | | | Home |
|--------------|-----------|------|------|------|------|
| Position (v) | LF | RF | LR | RR | |
| P1 | 4.52 | 1.22 | 4.55 | 0.97 | |
| P2 | 3.42 | 2.22 | 3.10 | 2.06 | |
| P3 | 1.96 | 3.31 | 1.25 | 2.90 | |
| Current | 3.39 | 2.28 | 3.15 | 2.09 | |

Info

The Menu Info screen displays information about the control system including:

WCU SW: software version of the WCU

WCU Boot: boot loader version of the WCU

WCU HW: hardware version of the WCU

ECU SW: software version of the ECU

ECU Boot: boot loader version of the ECU

ECU HW: hardware version of the ECU

Power Cycle: number of times the switched power has been turned on/off since the main power was connected

App Version: version of the mobile application

| Menu | Info | | Home |
|-------------|---------|--|------|
| WCU | | | |
| SW | 1.03.00 | | |
| Boot | 1.01 | | |
| HW | 02 | | |
| ECU | | | |
| SW | 1.03.00 | | |
| Boot | 1.04 | | |
| HW | 02 | | |
| Power Cycle | 25 | | |
| APP | | | |
| App Version | 1.3.8 | | |

RidePRO ~~X~~ Mobile App & Laptop Users Guide

Calibrate

The Menu Calibration screen allows the user to calibrate the system.

Though Calibration is not required for manual control of the system, Calibration is required to enable functionality of the Presets.

During Calibration, the system learns specific characteristics of the vehicle into which it is installed. This information is used by the system to accurately and efficiently reach preset destinations.

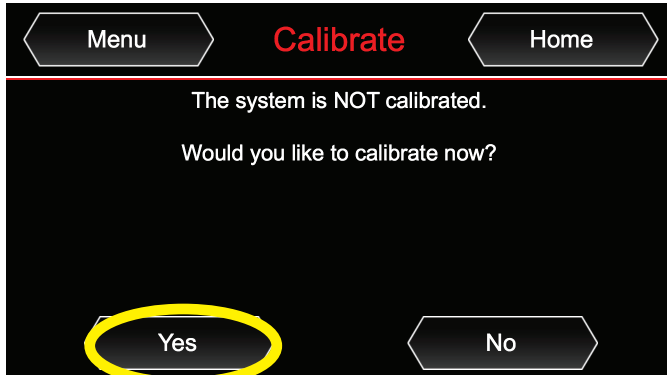

Make sure nothing is under the vehicle before performing calibration. To Calibrate the system, select "Yes".

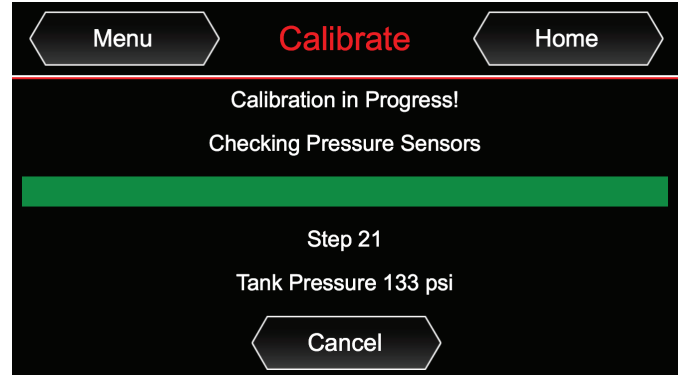

The system will tell you what it is doing through out the calibration.

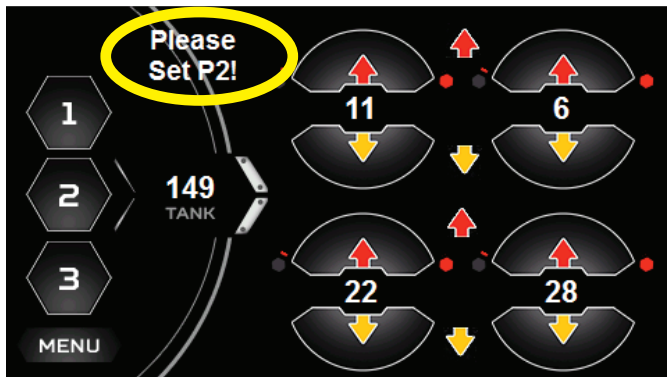

This screen will pop up after the sensors are calibrated. Use the Manual Up & Down Buttons to set your ride height. After you get your ride height set, hold the #2 for 5 seconds.

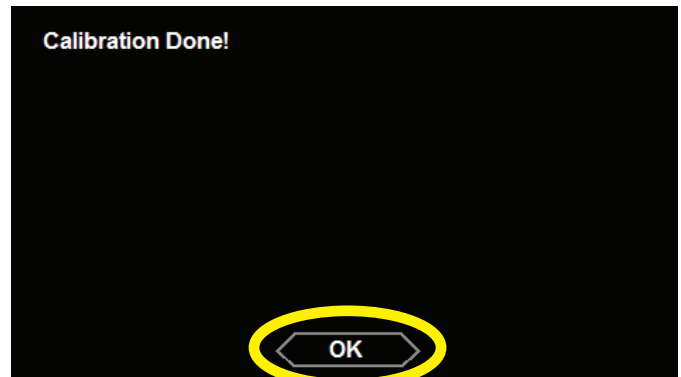

"Calibration Done" will pop up, select "OK".

Errors

The Menu Error History screen displays any errors that have occurred, as well as the ignition cycle during which they occurred.

| Error History | |
|---------------|-------|
| Error | Cycle |
| 96 | 4 |
| 76 | 4 |

RidePROX Mobile App & Laptop Users Guide

Wireless

The Menu Wireless screen allows one to learn a single PPM (Power Port Module) and two remote key fobs. It will also display information about two mobile devices.

The PPM can trigger presets at any time.

The Mobile App only works when the vehicle ignition is turned on.

The key fobs can only trigger presets when the vehicle ignition is off (this is for safety so a preset is not accidentally triggered when the vehicle is moving.)

To learn a Power Port Module using the Mobile App:

1-Press the Power Port Module button shown below.

2-A new screen will appear that states "Please Press Power Port Button".

3-Press any button on the Power Port Module.

4- A new screen will appear that states "Scan Finished". If it does not come up and the system times out, be sure the PPM has power. The 1, 2, 3 should be illuminated.

Keyfobs are learned in the same manner.

1. The Wireless menu screen with the Power Port Module button highlighted in yellow.

2. The screen displays "Please Press Power Port Module Button" with a green progress bar at the bottom.

3. A close-up of the Power Port Module with buttons 1, 2, and 3. Button 1 is highlighted in yellow.

4. The screen displays "Scan Finished" and "Power Port Module learned" with an OK button highlighted in yellow.

To learn a Smart Phone using a Laptop:

1. Open the RideTech App on your laptop.

2. Select the Phone #1 or #2 button shown below. "Please Connect Phone" along with a bar graph will appear at the bottom of the screen.

3. Touch the RTXXXXX number that is displayed on the "Available Devices" screen.

4. "Phone Learned" will pop-up, select Ok. It will return you to the Wireless Menu, touch the Home Button to return to the Main Screen.

1. The Wireless menu screen with the Phone #1 button highlighted in yellow.

2. The screen displays "Searching" and "Please Connect Phone" with a green progress bar at the bottom.

3. The "Available Devices" screen with the RT4974B number highlighted by a hand cursor.

4. The "E4 Monitor" screen displays "Phone Learned" with an Ok button highlighted in yellow.

The process of learning a PPM using a laptop, is the same as using a smartphone.

RidePRO ~~X~~ Mobile App & Laptop Users Guide

Diagnostics

The Menu Diagnostics screen can be used to diagnose problems/issues, specifically with the level sensor positioning during installation and/or the vehicle charging system.

Each corner can be manually inflated and deflated via the buttons surrounding the read out screen.

The readout screen displays the pressure and level sensor voltage (IF USING RIDE HEIGHT SENSORS) of each corner as well as the battery voltage in real time.

The top image is RidePRO-HP with ride height sensors. The bottom image is RidePRO-X without ride height sensors. If you have ride height sensors, it will display the voltage output of the level sensors. The range of the level sensors is 0.5 - 4.5 volts.

| Menu | | Diagnostics | | Home | |
|------|---------|-------------|---------------|------|--|
| LF-I | LF | Pressure 86 | Position 3.48 | RF-I | |
| LF-D | RF | 87 | 2.12 | RF-D | |
| LR-I | LR | 91 | 3.19 | RR-I | |
| LR-D | RR | 78 | 2.06 | RR-D | |
| | Tank | 145 | | | |
| | Battery | 11.9 | | | |

| Menu | | Diagnostics | | Home | |
|------|---------|-------------|---------------|------|--|
| LF-I | LF | Pressure 93 | Position 0.00 | RF-I | |
| LF-D | RF | 86 | 0.00 | RF-D | |
| LR-I | LR | 83 | 0.00 | RR-I | |
| LR-D | RR | 84 | 0.00 | RR-D | |
| | Tank | 140 | | | |
| | Battery | 13.4 | | | |

Dump Tank

The Menu Dump Tank screen provides a simple and easy way to completely drain an air storage tank for servicing or storage.

When the OK button is pressed all valves are opened, which exhausts the air from the tank to atmosphere. The compressors are disabled so the tank is not filled during this procedure.

The valves will remain open until tank pressure reaches 0 psi.

The compressors will remain disabled until the ignition is turned off then back on.

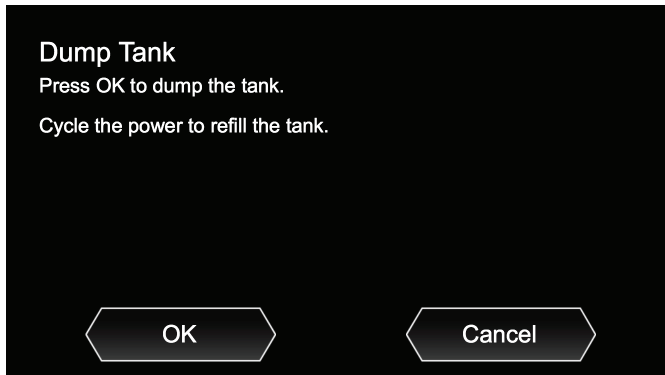

Dump Tank has a secondary screen to verify you want to dump the tank.



Calibration

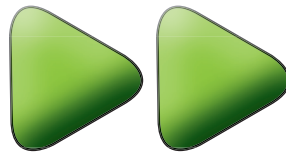

Calibration:

During the Calibration sequence, the RidePRO X-HP records information specific to the vehicle in which it is installed (inflate and deflate speed, if level sensors are present, how long the compressors take to fill the storage tank, etc.) The RidePRO X-HP then uses this information to attain the proper preset heights in the fewest possible steps, using the most intelligent method. For example, after calibration the RidePRO knows that the front of the vehicle is heavier and therefore slower than the rear, so it will inflate the front first then allow the rear to catch up just as the vehicle is achieving ride height.

NOTE: The RidePRO X-HP system is a very intelligent system. Attempting to calibrate this system on a non-running vehicle will cause errors. Trying to hook the system up for a "TEST RUN"? When the system is powered up, it will work manually using the inflate and deflate buttons only. The preset buttons will not work until calibration is complete. **Calibration should not be run until vehicle is running and driving.**

RidePRO X (No Level Sensors)

Calibration Steps: (items in red require user interface, other steps are automatically completed)

These steps will require the car to be running to ensure full battery voltage!

1. Start the vehicle
2. Allow the compressor/compressors to fill the tank (They will shut off @ 150psi)
3. Touch the MENU button to bring up the menu
4. Select the CALIBRATE button
5. Checking pressure sensors - locates and checks the air spring pressure sensors
6. Calibrate front up - sets the upper limit of suspension travel
7. Calibrate front down - sets the lower limit of suspension travel
8. Calibrate rear up - sets the upper limit of suspension travel
9. Calibrate rear down - sets the lower limit of suspension travel
10. System will return to the main screen, at this point you will need to set your 1,2,3 positions.
11. Do the #1 since the vehicle is already deflated. Hold #1 for 5 seconds or until the screen reads "P1 Saved". Select "OK" to return to the main screen.
12. Set your desired ride height and hold #2 until "P2 Saved" pops up. Select "OK".
13. Raise the vehicle to the extended height, hold #3 until "P3 Saved" pops up, Select "OK"
14. Calibration complete

RidePRO HP (with Level Sensors)

Calibration Steps: (items in red require user interface, other steps are automatically completed)

These steps will require the car to be running to ensure full battery voltage!

1. Start the vehicle
2. Allow the compressor/compressors to fill the tank (They will shut off @ 150psi)
3. Touch the MENU button to bring up the menu.
4. Select the CALIBRATE button.
5. Checking pressure sensors - locates and checks the air spring pressure sensors.
6. Checking position sensors - locates and checks the level sensors
7. Calibrate front up - sets the upper limit of suspension travel
8. Calibrate front down - sets the lower limit of suspension travel
9. Calibrate rear up - sets the upper limit of suspension travel
10. Calibrate rear down - sets the lower limit of suspension travel
11. "Set P2" on main screen - set the vehicle to your desired ride height and hold #2 for 5 seconds
12. Calibration complete- select the "OK". Display will return to the Main Screen.

RidePRO Troubleshooting Guide

| | | | |
|---|--|--|---|
| <p><u>Compressor will not turn on.</u></p> <p>Diagnosis A: 12 volts not present at Red wire on compressor.</p> <p>Solution A: Check fuse and connections. (20 amp fuse on Thomas compressor) (30 amp fuse on Viair compressor)</p> <p>Diagnosis B: 12 volts present at red wire on compressor but still doesn't run.</p> <p>Solution B: 1. Check connections between Black wire on compressor and Blue/Gray wire on ECU. Also check Black wire from ECU to Ground.</p> | <p><u>Compressor will not turn off.</u></p> <p>Diagnosis A: Tank pressure reads 0 psi all the time or stays at the same pressure regardless of actual tank pressure.</p> <p>Solution A: 1. Check harness and plugs. 2. Replace pressure sensor.</p> <p>Diagnosis B: Tank pressure builds normally but will not reach 150psi.</p> <p>Solution B: Replace compressor.</p> | <p><u>One air spring leaks down over a period of time.</u></p> <p>Diagnosis A: Leak between delivery port on valve block and air spring.</p> <p>Solution A: Air springs almost never leak. Spray all fittings with soapy water. Tighten fitting and/or remove and replace thread sealant. Cut 1" off of end of airline and reinsert.</p> <p>Diagnosis B: Exhaust valves leaking. Air seeps past exhaust valve and out exhaust port.</p> <p>Solution B: Usually caused by debris stuck on valve seat. Inflate and deflate several times or disassemble valve.</p> | |
| <p><u>Pressure reading are not moving, always reads 168 psi or 0 psi.</u></p> <p>Diagnosis: ECU is not receiving a proper signal from the sensor.</p> <p>Solution: 1. Check pressure sensor harness connections. 2. Replace sensor.</p> | <p><u>Height sensor bars read the incorrect corner.</u></p> <p>Diagnosis: Ex: When inflating RF air spring LF bar increases</p> <p>Solution: Swap height sensor harnesses at ECU.</p> | <p><u>Control panel switches do not activate the correct air spring.</u></p> <p>Diagnosis: Ex: LF switch actuates the RF air spring.</p> <p>Solution: Swap airline at the valve block.</p> | |
| <p><u>All 4 air springs leak down over a period of time.</u></p> <p>Diagnosis A: Check tank pressure. There is a leak in the supply side of the system. This could be at the comp., tank, or supply ports on the valve.</p> <p>Solution A: Spray all fittings with soapy water. Tighten fitting and/or remove and replace thread sealant. Cut 1" off of end of airline and reinsert.</p> | <p><u>Presets work, but does not achieve target.</u></p> <p>Diagnosis A: Air tank is too small. Air spring pressure equalizes with tank pressure before achieving preset pressure/height.</p> <p>Solution A: Reprogram #1 preset for the highest psi that allows the suspension to bottom out. Will give it a "head start".</p> <p>Diagnosis B: Tank pressure leaks down.</p> <p>Solution B: Fix leak on supply side of system.</p> | <p><u>Presets work, but does not achieve target.</u></p> <p>Diagnosis C: Pressure sensors and/or airline are not attached to corresponding air spring. (Ex: RF button must activate RF air spring and top right number on display.)</p> <p>Solution C: Swap airline at delivery port on valve and/or air pressure sensor harness's.</p> <p>Diagnosis D: Mechanical height sensors are out of range. Under "System Setup" check the presets voltages. If one or more are at 4.5v or .5v then the sensor is traveling beyond it's range of travel.</p> | |
| <p>NOTE: Target on pressure based systems is + or - 7 PSI Target on height based systems is + or - 1/4"</p> | | | <p>Solution D: Reduce or change travel of sensor by either changing linkage length, changing sensor arm length or by rotating sensor.</p> |

RidePRO Troubleshooting Guide

Control panel switches activate the correct air spring, but the air pressures read the wrong air spring.

Diagnosis: Ex: Inflating the RF air spring changes the top left psi readout on the panel

Solution: Swap pressure sensor harnesses at the sensors.

Wireless remote control does not function.

Diagnosis: After programming remotes to ECU they still do not function.

- Solution:**
1. Try to relearn the remote to the WCU.
 2. Replace Battery in Remote. LED will still light up even if the battery is near dead.
 3. Red wire must be connected to a constant 12v, Yellow to switched 12v.

Low Voltage Error.

Low Voltage Error is triggered if the system sees under 10.5 volts for an extended period of time. It will turn the compressors off to prevent the battery from being drained. The compressors will come back on after the battery voltage increases and stabilizes.

Solution A: Make sure the vehicle is running.

Solution B: Check all of your connections at the grounds and battery.

Solution C: If it is a common occurrence, you may need a larger alternator.

Error 143: Compressor #1 No Fill

Compressor has been installed improperly, or has failed. Is the compressor connected to the tank?
Are there any open ports or airline in the system?

If this does not resolve the issue please contact tech support.

OK

Error 143: Compressor #1 No Fill.

Diagnosis A: 5 gallon tank with 1 compressor or 1 compressor turned off.

Solution A: Add a second compressor, or turn the second compressor on in the Setup Menu.

Diagnosis B: Compressor isn't producing air.

Solution B: Check air line and connections between the compressor, tank, and valves.



TECH TIP

SUSPENSION BIND

Ever noticed that when you lower any vehicle off of a lift or jack stands that it is sitting several inches higher than normal? This condition is due to Suspension Bind, and all vehicles have it. Three dynamics lead to suspension bind:

1. **Tire Scrub** - The arc created by the control arm swing will try to push your tires apart or pull them together, (basically changing the track width). However, friction between the tire and ground does not allow the tires to slide, reducing vehicle movement. This can be especially dramatic with sticky tires and concrete.
2. **Control Arm Bushing** - Friction between the bushing and the frame brackets will also reduce vehicle movement. This is why control arm bolts must be tightened at ride height. Over-tightening the bolts can lead to very excessive suspension bind.
3. **Shock Absorbers** - The shock absorber's job is to reduce suspension movement. The stiffer the shock absorber, the more suspension bind.

With an air suspension vehicle, it is always best to over inflate the air spring and then deflate back down to the target pressure to alleviate some suspension bind.

RidePRO~~X~~ Plumbing Diagram

Single Compressor Systems

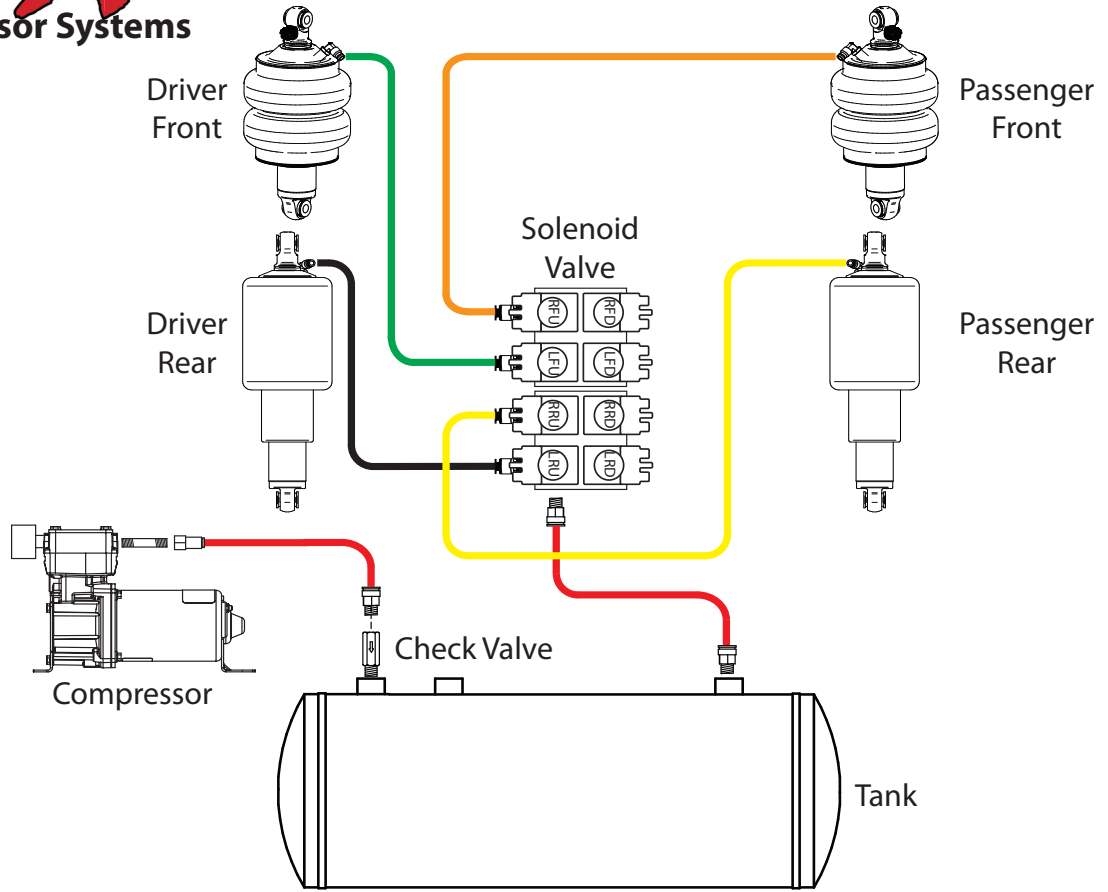

Dual Compressor Systems

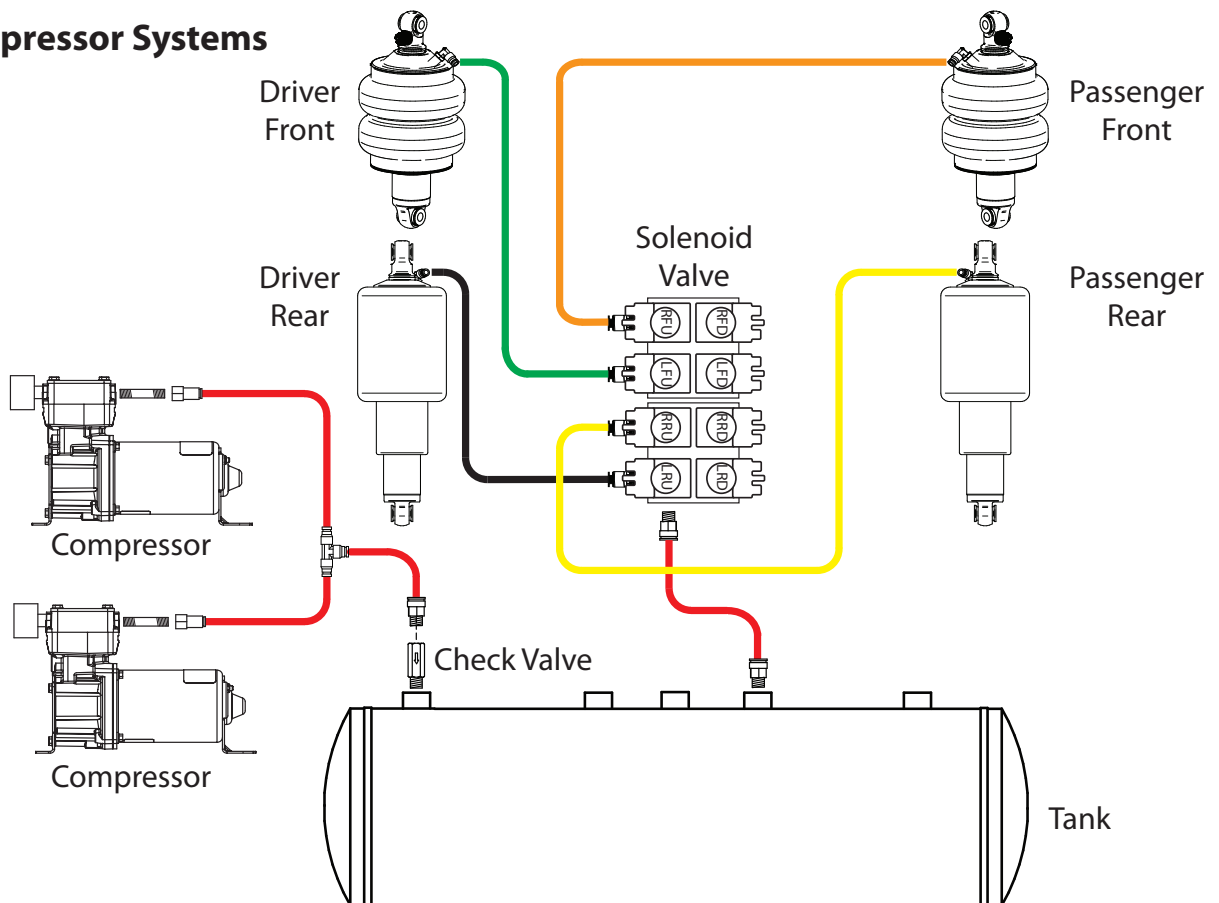

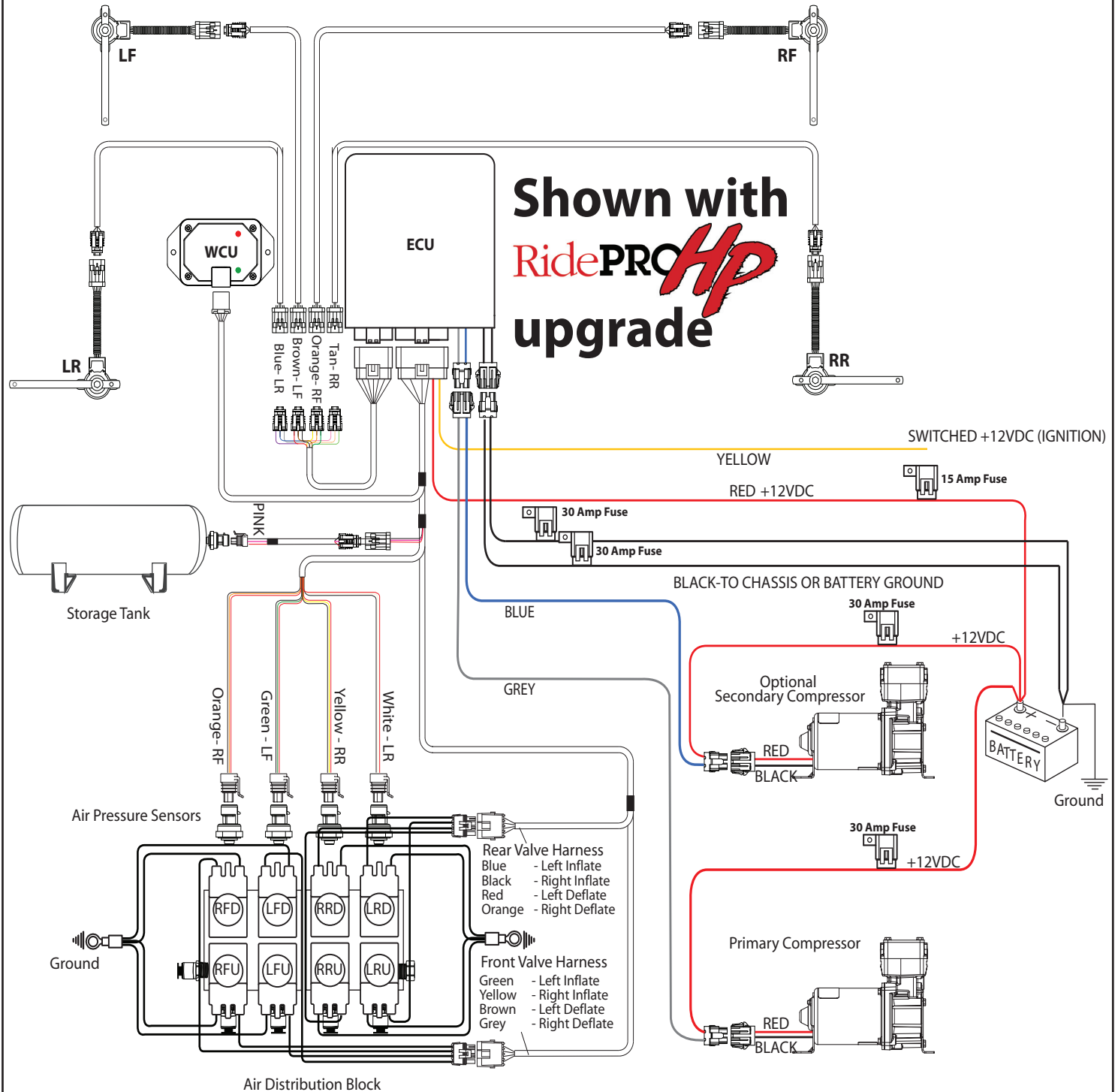

350 S. St. Charles St. • Jasper, IN 47546 • 812-481-4969