

Classic Update Series

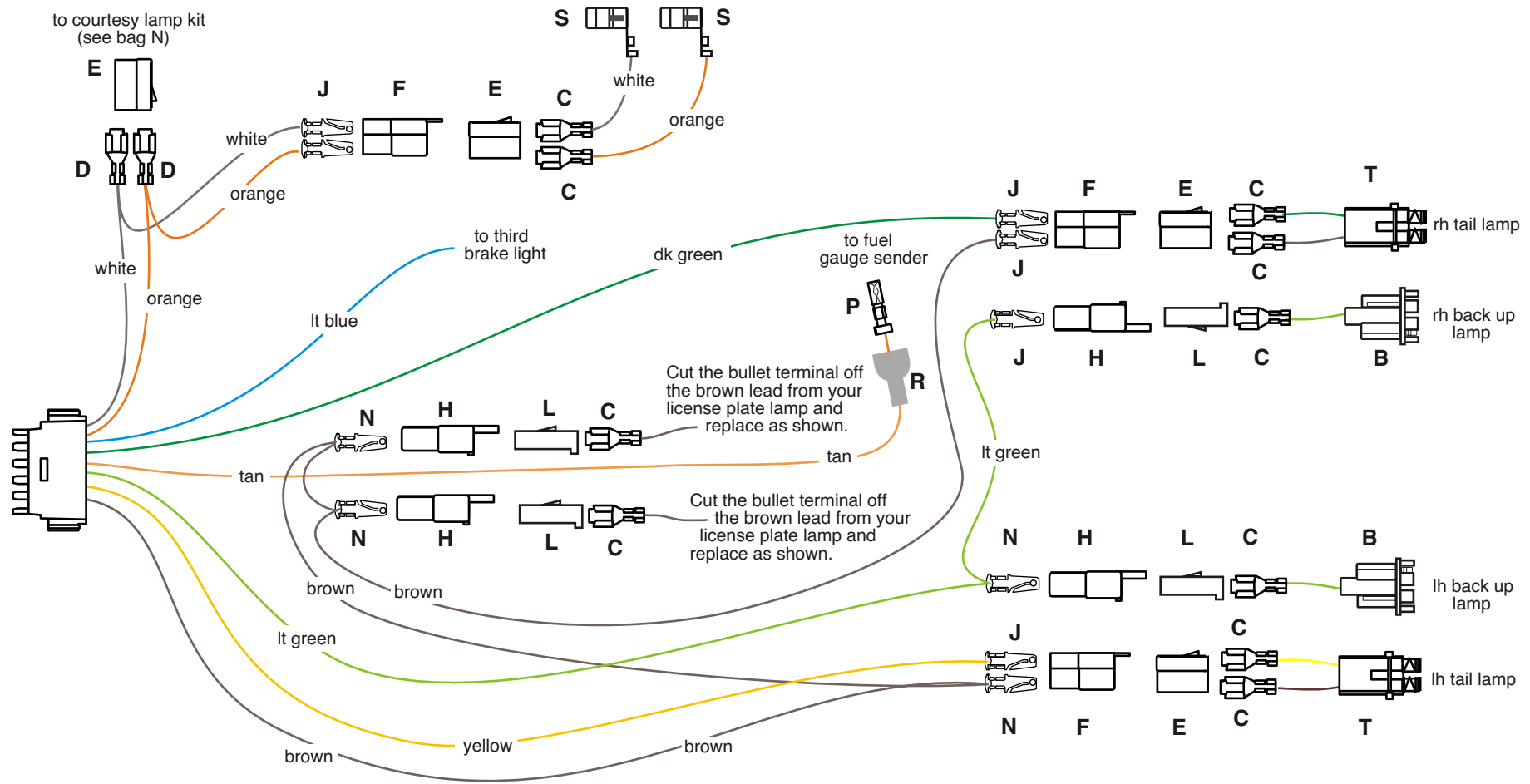

USE THIS SHEET FOR A
1964 El Camino or
 Station Wagon



American Autowire / Factory-Fit
 800-482-9473

Classic Update Series bag
X
 1964-67 El Camino &
 Station Wagon

OPTIONAL REAR BODY KIT

500999

92968245 instruction rev 0.0 11/07/2007

USE THIS SHEET FOR A 64 EL CAMINO OR STATION WAGON

(See kit 500986 for main instructions and parts usage)

Connect the main connector to the mating connector on the dash harness 500957 bag G. Route this harness along door sill and into trunk

LIGHT BLUE TAN Third brake light
Fuel Tank lead
(with rubber end)

Connect to the third brake lamp, if equipped.
Route wire to the sending unit at rear of the car, measure to proper length, cut to length, slide boot R onto wire, strip back end and crimp terminal P onto wire. Once terminal P is secured to wire, pull boot R down over terminal P and install onto sending unit.

BROWN Parking lamps

Route this wire to the LH tail lamp, cut to length, double this wire with the cut off portion, install terminal N and plug into connector F. Route the loose end to the LH license plate lamp, cut to length, double this wire with the cut off portion, install terminal N and plug into connector H. Route the loose end to the RH license plate lamp, cut to length, double this wire with the cut off portion, install terminal N and plug into connector H. Route the loose end to the RH tail lamp, cut to length, install terminal J and plug into connector F.

(NOTE: Cut the bullet terminals off of your existing tag lamp assembly leads and install terminals C and connectors L as shown)

YELLOW LH Stop / Tail

Route this wire to the LH tail lamp, cut to length, and install terminal J. Plug this wire into connector F from above. Install terminal C and connector E on the tail lamp pigtail T maintaining color continuity with connector F. Plug connector E into connector F.

DK GREEN RH Stop / Tail

Route this wire to the RH tail lamp, cut to length, and install terminal J. Plug this wire into connector F from above. Install terminal C and connector E on the tail lamp pigtail T maintaining color continuity with connector F. Plug connector E into connector F.

LIGHT GREEN Back up lamp feed

Route this wire to the LH back up lamp and trim to length and install terminal N and connector H. Route the loose end of the lt green wire to the right side back up lamp. Repeat this procedure with terminal J. Install terminals C on each of the back up pigtails B, and plug into connectors H.

WHITE Courtesy ground

At the driver's side kick panel area, cut this wire and double it with the cut off portion using terminal D, and plug into connector E maintaining color continuity with the mating connector in the courtesy lamp kit (bag N).

If you are using a dome lamp, route the loose end of this wire to the rear pillar area of the trunk, and install terminal J and connector F. Plug into connector F in location shown on sheet 1. (Note: a factory dome lamp harness will also plug into this connector, if you are not replacing the headliner at this time.) Install the loose white wire S (supplied with terminal installed) into the dome lamp. Route this wire to connector F (on white wire) location and trim to length. Install terminal C and connector E, maintaining color continuity with the white wire in connector F.

ORANGE Courtesy Lamp

At the driver's side kick panel area, cut this wire and double it with the cut off portion using terminal D, and plug into connector E maintaining color continuity with the mating connector in the courtesy lamp kit (bag N).

If you are using a dome lamp, route the loose end of this wire to the rear pillar area of the trunk, and install terminal J and connector F. Plug into connector F in location shown on sheet 1. (Note: a factory dome lamp harness will also plug into this connector, if you are not replacing the headliner at this time.) Install the loose orange wire S (supplied with terminal installed) into the dome lamp. Route this wire to connector F (on orange wire) location and trim to length. Install terminal C and connector E, maintaining color continuity with the orange wire in connector F.

(NOTE: Install clip 10 clips X as needed across the back of the car)

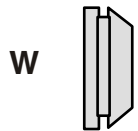
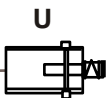
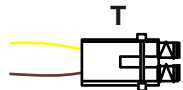

Classic Update Series

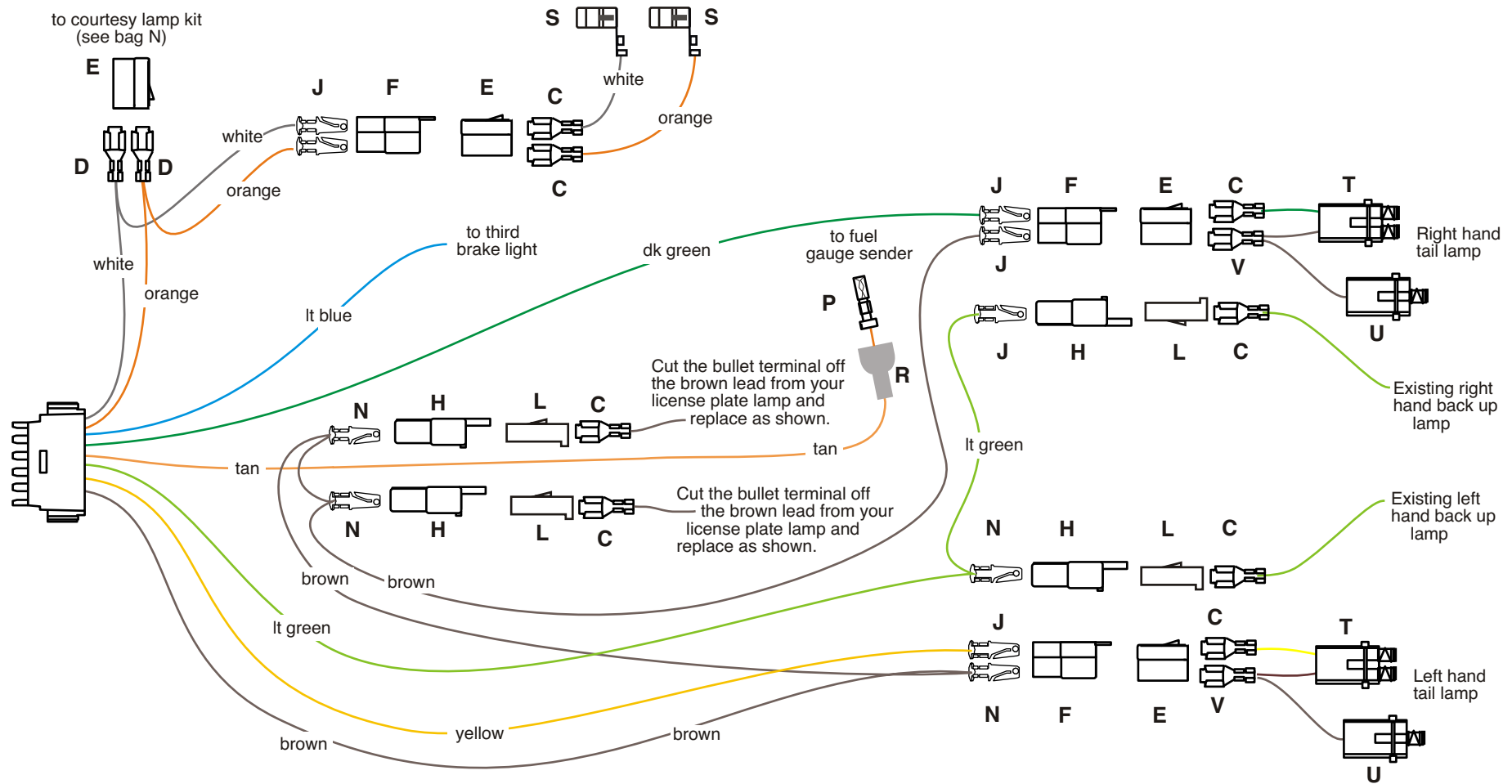

USE THIS SHEET FOR A
1965 El Camino or
 Station Wagon



American Autowire / Factory-Fit
 800-482-9473

Classic Update Series
 1964-67 El Camino &
 Station Wagon



OPTIONAL REAR BODY KIT

500999

92968245 instruction rev 0.0 11/07/2007

USE THIS SHEET FOR A 65 EL CAMINO OR STATION WAGON

(See kit 500986 for main instructions and parts usage)

Connect the main connector to the mating connector on the dash harness 500957 bag G. Route this harness along door sill and into trunk

LIGHT BLUE
TAN
Third brake light
Fuel Tank lead
(with rubber end)

Connect to the third brake lamp, if equipped.
Route wire to the sending unit at rear of the car, measure to proper length, cut to length, slide boot R onto wire, strip back end and crimp terminal P onto wire. Once terminal P is secured to wire, pull boot R down over terminal P and install onto sending unit.

BROWN
Parking lamps

Route this wire to the LH tail lamp, cut to length, double this wire with the cut off portion, install terminal N and plug into connector F. Route the loose end to the LH license plate lamp, cut to length, double this wire with the cut off portion, install terminal N and plug into connector H. Route the loose end to the RH license plate lamp, cut to length, double this wire with the cut off portion, install terminal N and plug into connector H. Route the loose end to the RH tail lamp, cut to length, install terminal J and plug into connector F.

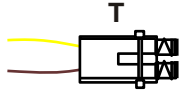

(NOTE1: Cut the bullet terminals off of your existing tag lamp assembly leads and install terminals C and connectors L as shown)

(NOTE 2: Double the 2 brown lead wires from tail lamp pigtails T and U together using terminal V and plug into connector E maintaining color continuity with connector F as shown)

YELLOW
LH Stop / Tail

Route this wire to the LH tail lamp, cut to length, and install terminal J. Plug this wire into connector F from above. Install terminal C and connector E on the tail lamp pigtail T maintaining color continuity with connector F. Plug connector E into connector F.

DK GREEN
RH Stop / Tail

Route this wire to the RH tail lamp, cut to length, and install terminal J. Plug this wire into connector F from above. Install terminal C and connector E on the tail lamp pigtail T maintaining color continuity with connector F. Plug connector E into connector F.

LIGHT GREEN
Back up lamp feed

Route this wire to the LH back up lamp and trim to length and install terminal N and connector H. Route the loose end of the lt green wire to the right side back up lamp. Repeat this procedure with terminal J. Install terminals C onto your existing back up pigtails and plug into connectors H.



(NOTE: Cut the bullet terminals off of your existing B/U lamp assembly leads and install terminals C and connectors L as shown)

WHITE
Courtesy ground

At the driver's side kick panel area, cut this wire and double it with the cut off portion using terminal D, and plug into connector E maintaining color continuity with the mating connector in the courtesy lamp kit (bag N).

If you are using a dome lamp, route the loose end of this wire to the rear pillar area of the trunk, and install terminal J and connector F. Plug into connector F in location shown on sheet 1. (Note: a factory dome lamp harness will also plug into this connector, if you are not replacing the headliner at this time.) Install the loose white wire S (supplied with terminal installed) into the dome lamp. Route this wire to connector F (on white wire) location and trim to length. Install terminal C and connector E, maintaining color continuity with the white wire in connector F.

W

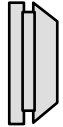

ORANGE
Courtesy Lamp

At the driver's side kick panel area, cut this wire and double it with the cut off portion using terminal D, and plug into connector E maintaining color continuity with the mating connector in the courtesy lamp kit (bag N).

If you are using a dome lamp, route the loose end of this wire to the rear pillar area of the trunk, and install terminal J and connector F. Plug into connector F in location shown on sheet 1. (Note: a factory dome lamp harness will also plug into this connector, if you are not replacing the headliner at this time.) Install the loose orange wire S (supplied with terminal installed) into the dome lamp. Route this wire to connector F (on orange wire) location and trim to length. Install terminal C and connector E, maintaining color continuity with the orange wire in connector F.

X



(NOTE: Install 10 clips X as needed across the back of the car)

Classic Update Series

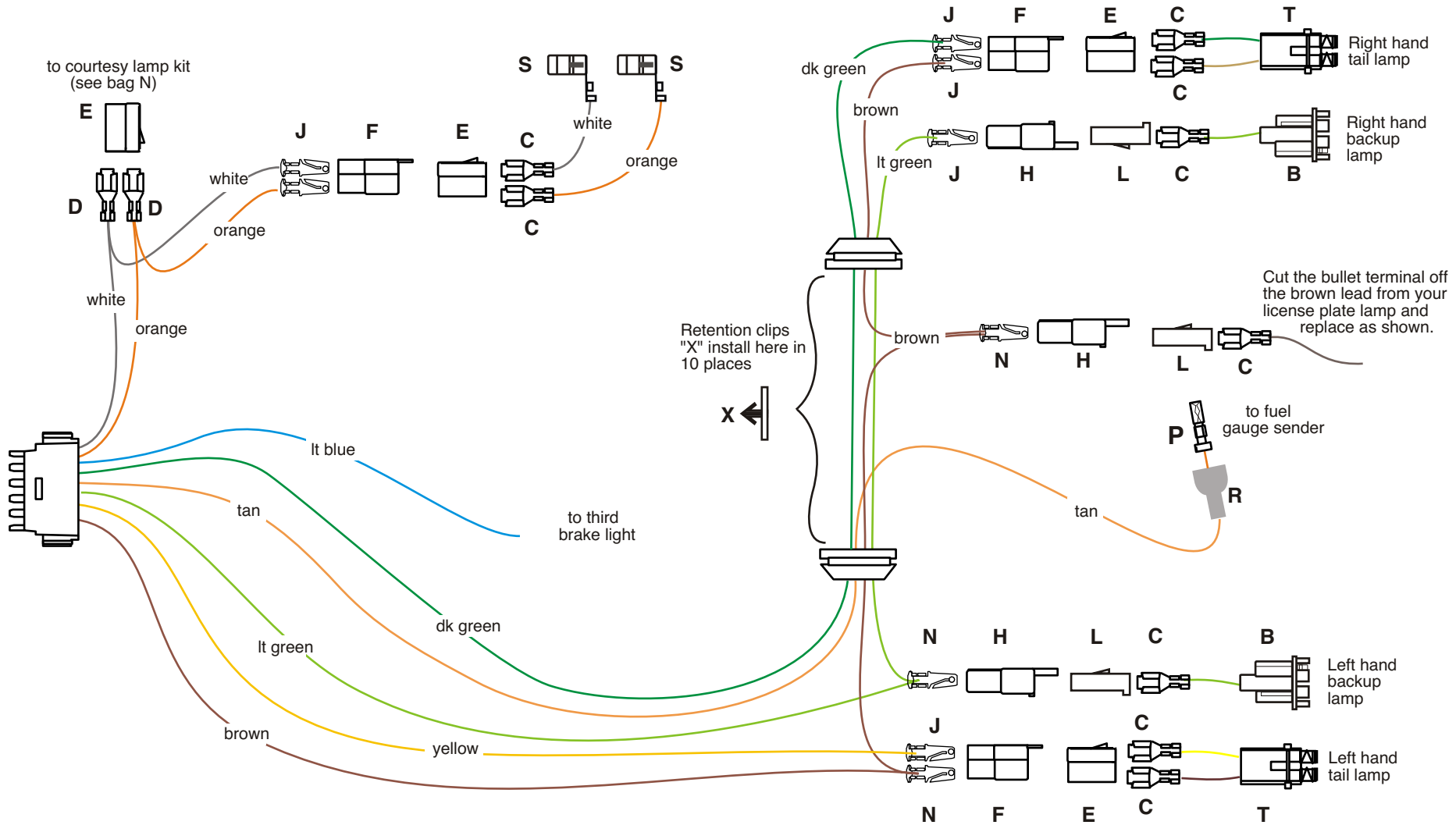

USE THIS SHEET FOR A
1966 El Camino or
 Station Wagon



American Autowire / Factory-Fit
 800-482-9473

Classic Update Series
 1964-67 El Camino &
 Station Wagon



OPTIONAL REAR BODY KIT

500999

92968245 instruction rev 0.0 11/07/2007

USE THIS SHEET FOR A 66 EL CAMINO OR STATION WAGON

(See kit 500986 for main instructions and parts usage)

Connect the main connector to the mating connector on the dash harness 500957 bag G. Route this harness along door sill and into trunk

LIGHT BLUE TAN Third brake light Fuel Tank lead (with rubber end)

Connect to the third brake lamp, if equipped.
Route wire to the sending unit at rear of the car. Measure to proper length going thru LH grommet W as shown on sheet 5, cut to length. Slide boot R onto wire, strip back end and crimp terminal P onto wire. Once terminal P is secured to wire, pull boot R down over terminal P and install onto sending unit. Route this wire to the LH tail light and trim to length. Double this wire with the cut off portion, install terminal N and plug into connector F. Route the loose end going thru LH grommet W as shown on sheet 5 to the license plate lamp. Cut to length and double this wire with the cut off portion using terminal N, then plug into connector H. Route the loose end to the RH tail lamp going thru RH grommet W as shown on sheet 5, trim to length, install terminal J and plug into connector F.

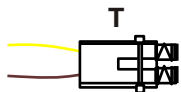

BROWN Parking lamps

(NOTE1: Cut the bullet terminal off of your existing tag lamp assembly lead and install terminal C and connector L as shown)

YELLOW LH Stop / Tail

Route this wire to the LH tail lamp, cut to length and install terminal J. Plug this wire into connector F from above. Install terminal C and connector E on the tail lamp pigtail T, maintaining color continuity with connector F. Plug connector E into connector F.

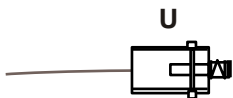

DK GREEN RH Stop / Tail

Route this wire to the RH tail lamp thru LH and RH grommets W as shown on sheet 5, cut to length and install terminal J. Plug this wire into connector F from above. Install terminal C and connector E on the tail lamp pigtail T, maintaining color continuity with connector F. Plug connector E into connector F.

LIGHT GREEN Back up lamp feed

Route this wire to the LH back up lamp, trim to length, double this wire with the cut off portion using terminal N and plug into connector H. Route the loose end of the wire thru LH and RH grommets W as shown on sheet 5 to the right side back up lamp and install terminal J and connector H. Install terminal C on each of the back up pigtails B, and plug each into connector L. Plug Connector L into connector H. At the driver's side kick panel area, cut this wire and double it with the cut off portion using terminal D, and plug into connector E maintaining color continuity with the mating connector in the courtesy lamp kit (bag N).



WHITE Courtesy ground

If you are using a dome lamp, route the loose end of this wire to the rear pillar area of the trunk, and install terminal J and connector F. Plug into connector F in location shown on sheet 1. (Note: a factory dome lamp harness will also plug into this connector, if you are not replacing the headliner at this time.) Install the loose white wire S (supplied with terminal installed) into the dome lamp. Route this wire to connector F (on white wire) location and trim to length. Install terminal C and connector E, maintaining color continuity with the white wire in connector F.

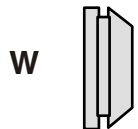

ORANGE Courtesy Lamp

At the driver's side kick panel area, cut this wire and double it with the cut off portion using terminal D, and plug into connector E maintaining color continuity with the mating connector in the courtesy lamp kit (bag N).



If you are using a dome lamp, route the loose end of this wire to the rear pillar area of the trunk, and install terminal J and connector F. Plug into connector F in location shown on sheet 1. (Note: a factory dome lamp harness will also plug into this connector, if you are not replacing the headliner at this time.) Install the loose orange wire S (supplied with terminal installed) into the dome lamp. Route this wire to connector F (on orange wire) location and trim to length. Install terminal C and connector E, maintaining color continuity with the orange wire in connector F.

(NOTE: Install 10 clips X as needed across the back of the car)

Classic Update Series

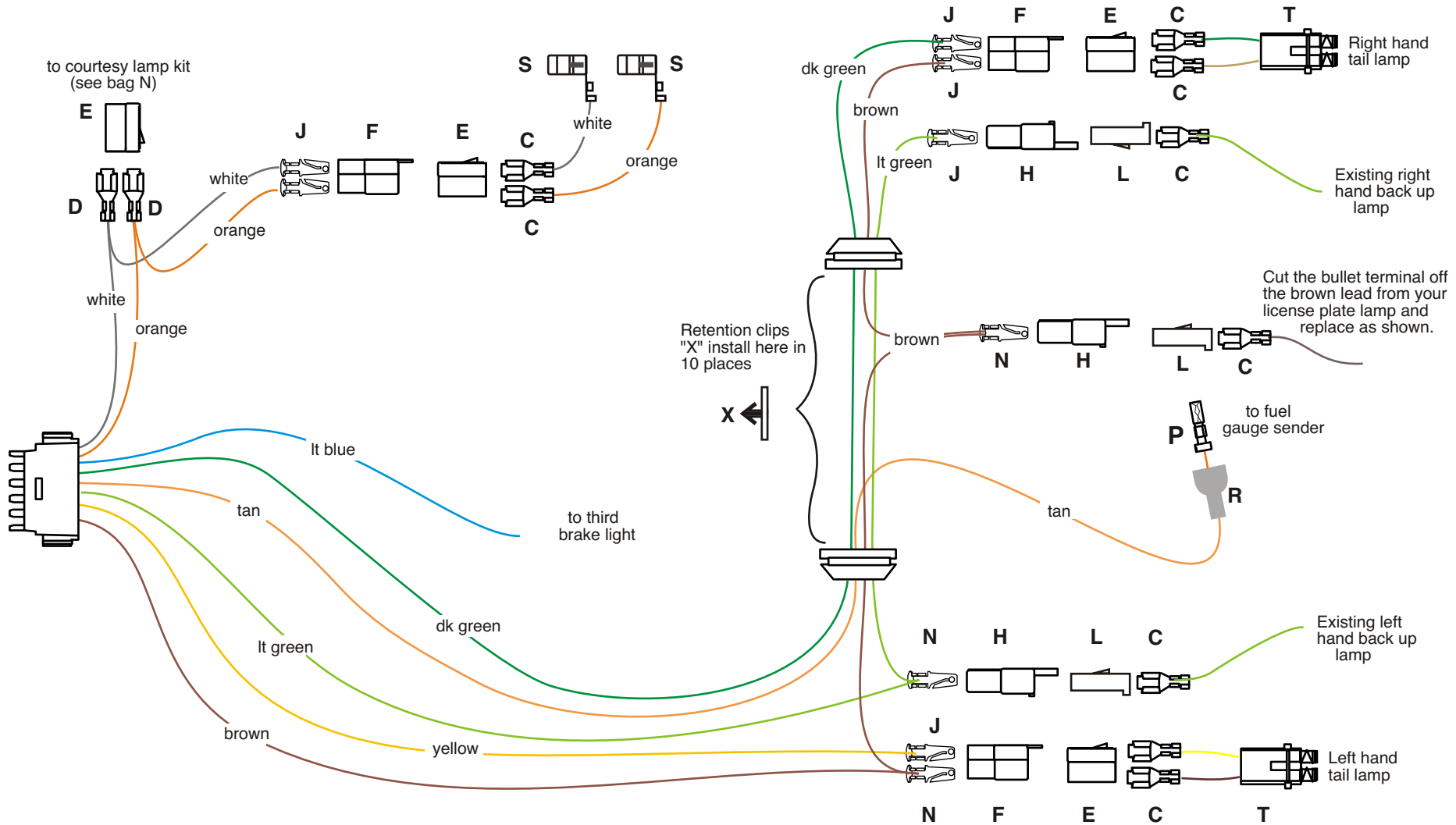

USE THIS SHEET FOR A
1967 El Camino or
 Station Wagon



American Autowire / Factory-Fit
 800-482-9473

Classic Update Series bag
X
 1964-67 El Camino &
 Station Wagon

OPTIONAL REAR BODY KIT

500999

92968245 instruction rev 0.0 11/07/2007

USE THIS SHEET FOR A 67 EL CAMINO OR STATION WAGON

(See kit 500986 for main instructions and parts usage)

Connect the main connector to the mating connector on the dash harness 500957 bag G. Route this harness along door sill and into trunk

LIGHT BLUE
TAN Third brake light
Fuel Tank lead
(with rubber end)

Connect to the third brake lamp, if equipped.
Route wire to the rear of the car to the sending unit. Measure to proper length going thru LH grommet W as shown on sheet 5, cut to length. Slide boot R onto wire, strip back end and crimp terminal P onto wire. Once terminal P is secured to wire, pull boot R down over terminal P and install onto sending unit. Route this wire to the LH tail light and trim to length. Double this wire with the cut off portion, install terminal N and plug into connector F. Route the loose end going thru LH grommet W as shown on sheet 5 to the license plate lamp. Cut to length and double this wire with the cut off portion using terminal N, then plug into connector H. Route the loose end to the RH tail lamp going thru RH grommet W as shown on sheet 5, trim to length, install terminal J and plug into connector F.

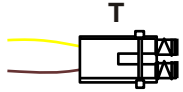

BROWN Parking lamps

(NOTE: Cut the bullet terminal off of your existing tag lamp assembly lead and install terminal C and connector L as shown)

YELLOW LH Stop / Tail

Route this wire to the LH tail lamp, cut to length and install terminal J. Plug this wire into connector F from above. Install terminal C and connector E on the tail lamp pigtail T, maintaining color continuity with connector F. Plug connector E into connector F.

DK GREEN RH Stop / Tail

Route this wire to the RH tail lamp thru LH and RH grommets W as shown on sheet 5, cut to length and install terminal J. Plug this wire into connector F from above. Install terminal C and connector E on the tail lamp pigtail T, maintaining color continuity with connector F. Plug connector E into connector F.

LIGHT GREEN Back up lamp feed

Route this wire to the LH back up lamp, trim to length, double this wire with the cut off portion using terminal N and plug into connector H. Route the loose end of the wire thru LH and RH grommets W as shown on sheet 5 to the right side back up lamp and install terminal J and connector H. Cut the bullet terminal off of your existing B/U lamp assembly leads, install terminal C, and plug each into connector L. Plug Connector L into connector H.

WHITE Courtesy ground

At the driver's side kick panel area, cut this wire and double it with the cut off portion using terminal D, and plug into connector E maintaining color continuity with the mating connector in the courtesy lamp kit (bag N).

If you are using a dome lamp, route the loose end of this wire to the rear pillar area of the trunk, and install terminal J and connector F. Plug into connector F in location shown on sheet 1. (Note: a factory dome lamp harness will also plug into this connector, if you are not replacing the headliner at this time.) Install the loose white wire S (supplied with terminal installed) into the dome lamp. Route this wire to connector F (on white wire) location and trim to length. Install terminal C and connector E, maintaining color continuity with the white wire in connector F.

ORANGE Courtesy Lamp

At the driver's side kick panel area, cut this wire and double it with the cut off portion using terminal D, and plug into connector E maintaining color continuity with the mating connector in the courtesy lamp kit (bag N).

If you are using a dome lamp, route the loose end of this wire to the rear pillar area of the trunk, and install terminal J and connector F. Plug into connector F in location shown on sheet 1. (Note: a factory dome lamp harness will also plug into this connector, if you are not replacing the headliner at this time.) Install the loose orange wire S (supplied with terminal installed) into the dome lamp. Route this wire to connector F (on orange wire) location and trim to length. Install terminal C and connector E, maintaining color continuity with the orange wire in connector F.

(NOTE: Install 10 clips X as needed across the back of the car)

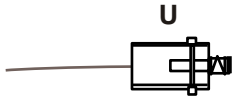

W

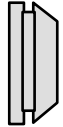

X

