

Classic Update Series

1973-82 Chevy & GMC Truck

START HERE !

PLEASE READ THIS BEFORE STARTING INSTALLATION !

This wiring kit is designed for ease of installation. Please read the guidelines below, BEFORE STARTING your installation, to guarantee a successful job! Use an appropriate crimping tool which folds the crimp wings on the terminals as shown below. Top quality crimping tools are available from American Autowire or American Autowire authorized dealers.

NOTE: ALL TERMINALS THAT YOU INSTALL SHOULD BE PROPERLY SOLDERED.

Our factory terminations are installed by GM approved termination presses, and soldering is not necessary on these terminations.

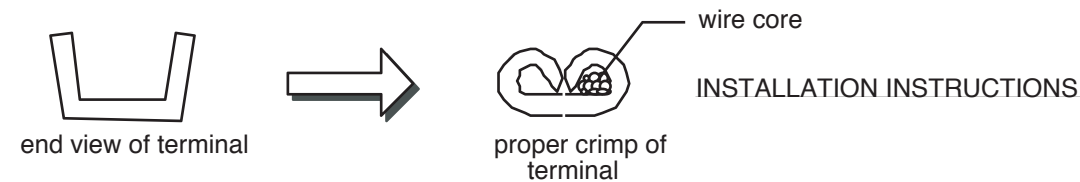

STEP 1: DISCONNECT YOUR BATTERY:

Disconnect the battery before installing the wiring kit to prevent any accidental shorting caused by loose bare wire ends.

STEP 2: START INSTALLING KIT:

This kit is broken down into individual steps that are identified by a letter printed on the instruction sheets visible through each bag. These letters are the order of operation for installing your kit. Start with the bag letter G, then H, etc. The order of installation is shown below.

- G 510351 Dash Harness Kit
- H 510356 Instrument Cluster Kit
- J 510348 Engine Kit
- L 510349 Front Light Kit
- M 510350 Rear Body Kit
- N 510354 Courtesy Light Kit

STEP 3: RECONNECT YOUR BATTERY:

When you have completed the installation and are ready to reconnect the battery, make sure that the following electrical system grounds are in place:

- A. Battery is grounded to the ENGINE BLOCK.
- B. Battery is grounded to the frame.
- C. Engine block is grounded to the frame.
- D. Body is grounded to the frame.

STEP 4: CHECK ALL ELECTRICAL FUNCTIONS:

Any non-functioning items should be checked for proper installation. Any problems with your wiring and electrical circuit functions should be addressed to American Autowire Systems, Inc. as soon as possible to avoid any warranty problems.

If you have any questions concerning this or any of our products, please feel free to call us at 1-800-482-WIRE.

AMERICAN AUTOWIRE MAKES IT EASY !!

We carry many accessories for your 1973-82 Chevy Truck

p/n R0067108
OEM style non-stick harness tape



p/n 38131
Breakerless Ignition Module,
GM V-8 POINT CONVERSION KIT



p/n 500523
OEM large terminal and double
crimping tool (20-8 gauge).



p/n 500649
Multi-crimp tool (20-14 gauge).

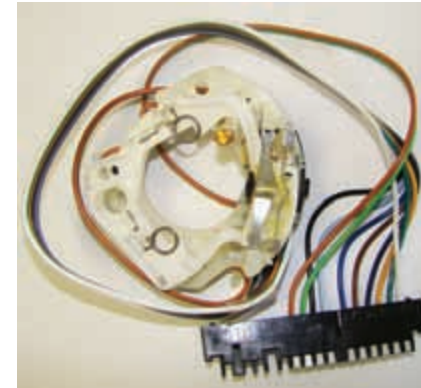

OEM steering column turn signal switch.

p/n 01893596 (1973-75) - all, with tilt
p/n 01997938 (1973-76) - all, without tilt, (includes lead wiring)
p/n 01997938US (1973-76) - all, without tilt,
DELCO GUIDE TOOLING
(includes lead wiring)

p/n 01893591 (1976-76) - all, with tilt,
p/n 01997983 (1977-77) - CK, (includes lead wiring)
p/n 01997985 (1977-83) - CK, without tilt, (includes lead wiring)

OEM style neutral safety/backup switch.

p/n 01994235 (1973-75)
Column shift TH auto. trans.
p/n 01994163 (1976-80)
Column shift auto. trans.



OEM style wiper switch.

p/n 01994151 (1973-74) Wiper Switch
p/n 01994172 (1975-77) Wiper Switch



p/n 39354 (1982-82)
Factory assembly manual.
(It's what they used on the assembly
line to build your Truck!)



American Autowire / Factory-Fit
800-482-9473

Classic Update Series

1973-82 Chevy &
GMC Truck

510347

© COPYRIGHT 2004 American Autowire / Factory-Fit
Used with express permission of
American Autowire / Factory-Fit
92970223 instruction sheet rev. 0.0 11/16/2012

Classic Update Series

1973-82 Chevy & GMC Truck

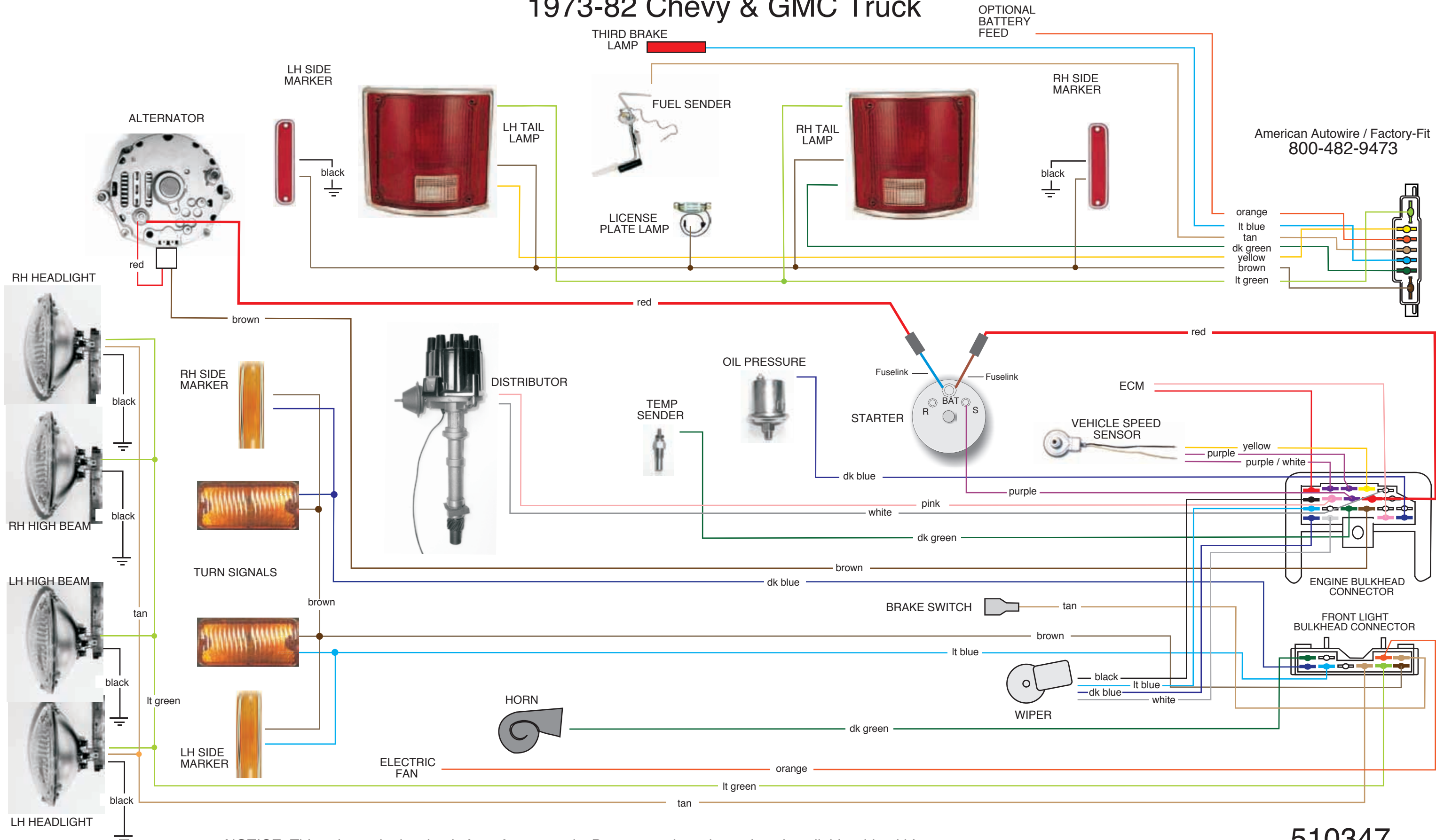

American Autowire / Factory-Fit
800-482-9473

NOTICE: This schematic drawing is for reference only. Do not use the schematic to install this wiring kit! Use the instruction sheets included in each bag, which includes directions for proper terminations, and specific applications).

510347

© COPYRIGHT 2004 American Autowire / Factory-Fit
Used with express permission of
American Autowire / Factory-Fit
92970223 instruction sheet rev. 0.0 11/16/2012

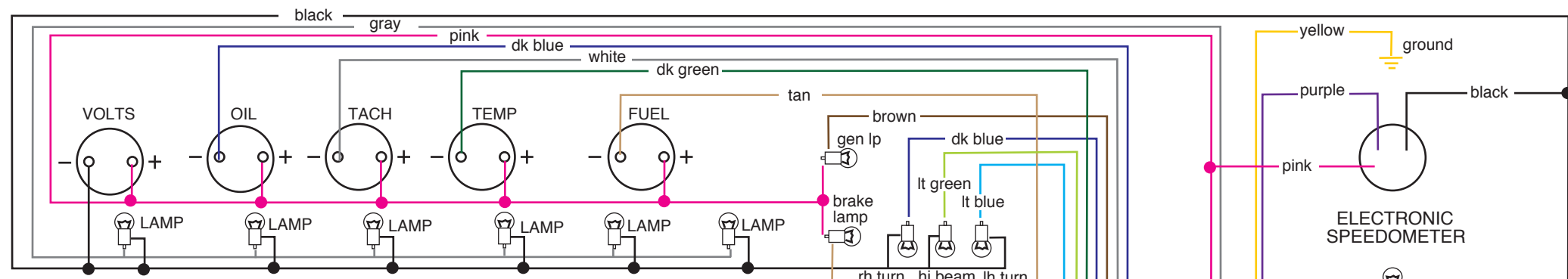

American Autowire / Factory-Fit
800-482-9473

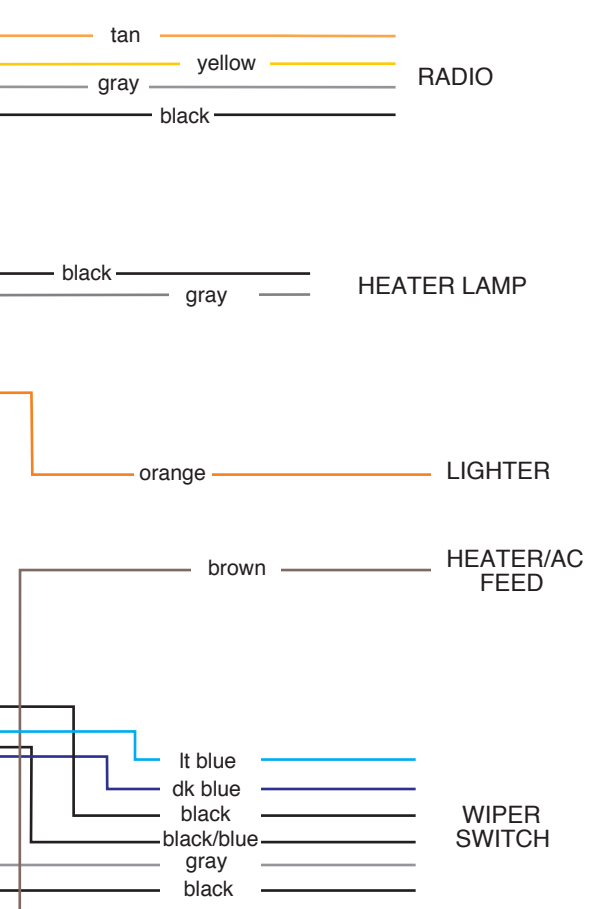
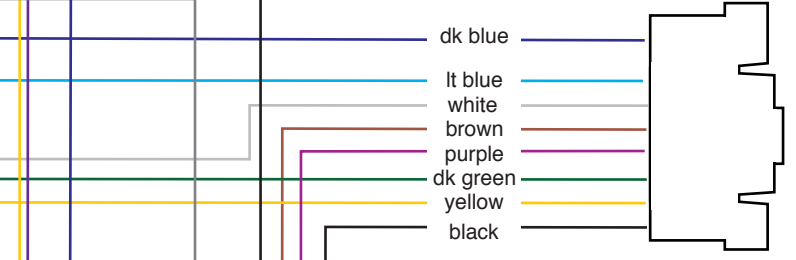
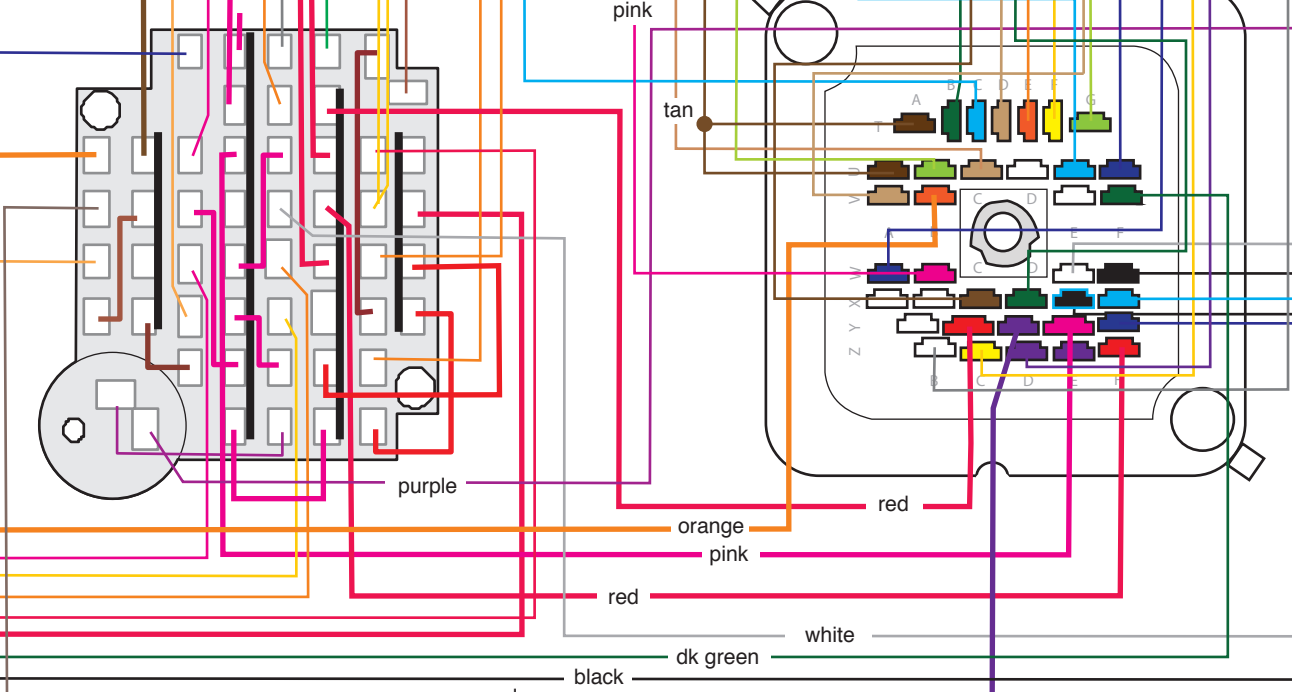
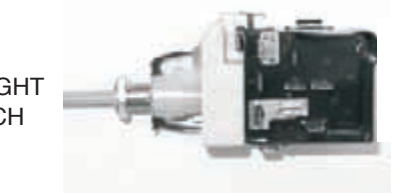
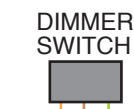
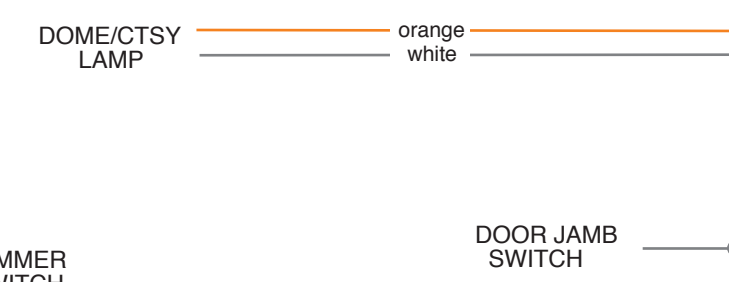

510347

THIS PAGE HAS BEEN INTENTIONALLY LEFT BLANK