



WARNING:

Validate the kit contents with the component list included on this page before proceeding. This kit is intended to be used in a **modified** vehicle. Please read this page thoroughly and be sure that you understand everything prior to opening any enclosed packages, or before attempting to install any components. Once this kit has been opened or a component installed the kit is not returnable.

This American Autowire wiring system is intended for highly **modified** applications only.

This kit **DOES NOT** include any of the following:

- Wiring for any factory original A/C system, but will support all 68-76 factory A/C harnesses. A full listing of the factory replacement A/C harnesses can be found on page 9. It does include all the wiring for the 1968-74 factory heater only system. The 1975 (p/n 01680) and 1976 (p/n 27545) heater harnesses were stand alone units and can be purchased separately. It will also support any aftermarket heating or A/C system.
- The rear compartment lamp (roadster) or rear door pillar lamp (coupe) harnesses for the 1968 models. These items may be purchased separately (P/N's 01115 - roadster; 01117 - coupe).
- Front or rear fiber-optic sub-assemblies. These items may be purchased separately (P/N's 16165, 1968-71 front assembly; 37989, 1968-69 rear assembly; 16160, 1970-71 rear assembly).
- New ignition switches. This kit is wired for both the factory dash ('68) and column ('69-'76) mounted switches. Connectors and pigtails are provided to connect to either of the original style switches.
- New headlight switch as they are unique due to the vacuum circuits. You can reuse your original, or purchase a new switch from most Corvette parts vendors.
- Harness connections for factory emissions equipment.
- The factory alarm system or "door ajar" warning system.
- Adapters for later model ('86+) alternators. An SI-series alternator connector is included. Adapters for other alternators can be purchased separately.
- Front parking lamp assembly wires/extensions.

510717 - Classic Update Series Kit 1968-76 Corvette

This kit contains the following components:

Bag	Part Number	Description	Quantity
	500042	Dimmer Swtich	1
	500919	Practice Terminal Crimping Set	1
	510716	Fuse, Relay, and Flasher kit	1
Z	510476	Alternator and Main Connection kit	1
G	510718	Dash Harness kit	1
H	510719	Instrument Cluster wiring kit	1
J	510720	Engine Wiring kit	1
L	510721	Front Light Wiring kit	1
M	510722	Rear Body Wiring kit	1
N	510723	Courtesy Light kit	1
V	510730	VSS Connection kit	1

Validate the kit contents with this component list. If there are any discrepancies with incorrect or missing parts, stop your installation and notify the supplier you purchased the kit from before proceeding.



**American
Autowire**

www.americanautowire.com 856-933-0801

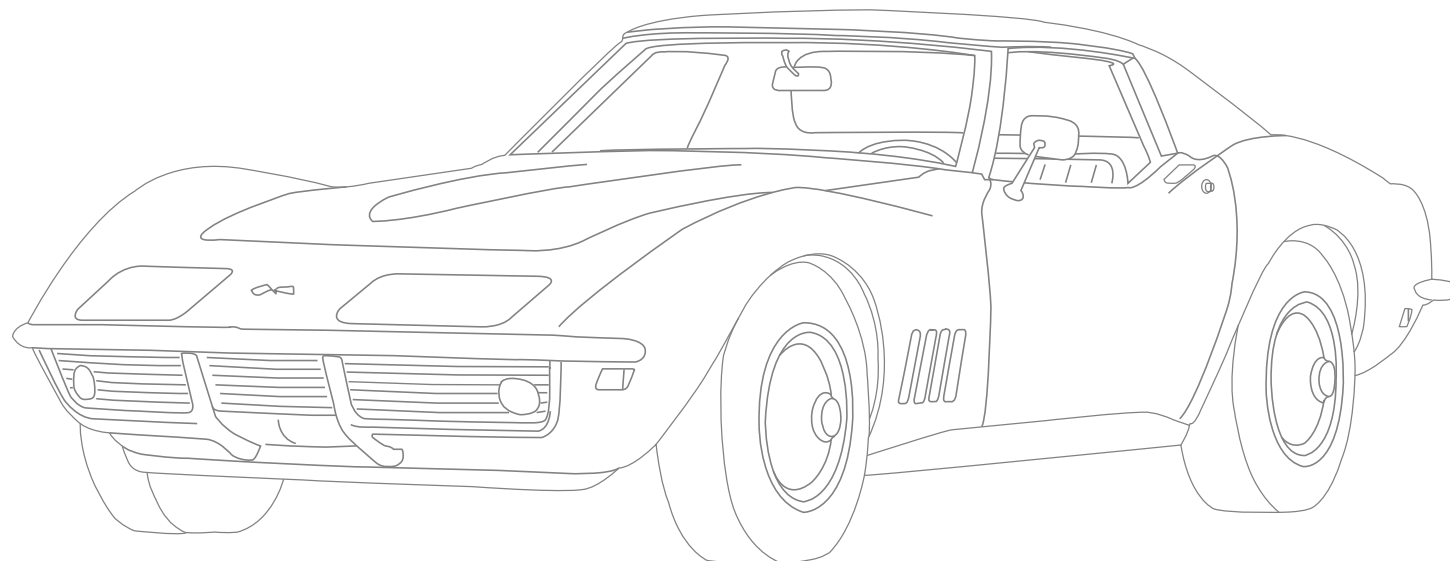

1968-76 Corvette

Classic Update Series

510717

© COPYRIGHT 2004 American Autowire / Factory-Fit
Used with express permission of
American Autowire / Factory-Fit

92972159 Rev 5.0 1/26/2021

START HERE!

PLEASE READ THIS BEFORE STARTING INSTALLATION!

This wiring kit is designed for ease of installation. Please read the guidelines below **BEFORE STARTING** your installation. Use a crimping tool that folds the wings of the open barrel terminals down into the wire as shown on this page. If you use our crimping tools and correctly crimp the included terminals, soldering is not necessary. If you are unsure about a particular crimp, soldering is recommended. Our factory crimped terminations are installed by GM approved five ton presses and soldering these terminations is not necessary.



AAW offers a great terminal crimping video entitled "Proper Crimping Video". It can be viewed by visiting YouTube.

Type the following address into your web browser, to go directly to the video:
www.youtube.com/watch?v=JAgEDoVI-co

Youtube Channel:
www.youtube.com/user/WiringHarness



The terminals that we supply in our kits utilize what is known as an F crimp. When done correctly the F crimp cross section will look like the illustration below.

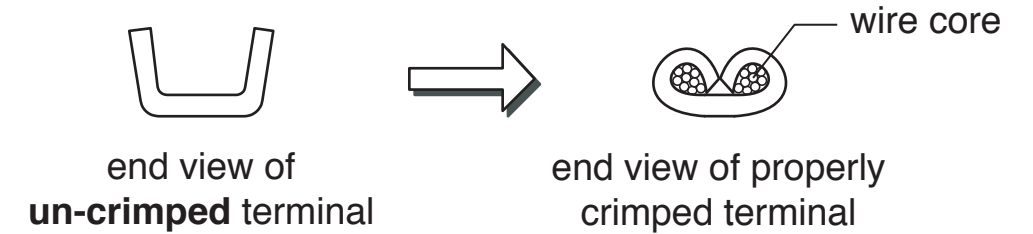

We carry the following crimping hand tools to help with your installation.

These hand tools are available for purchase or rental.

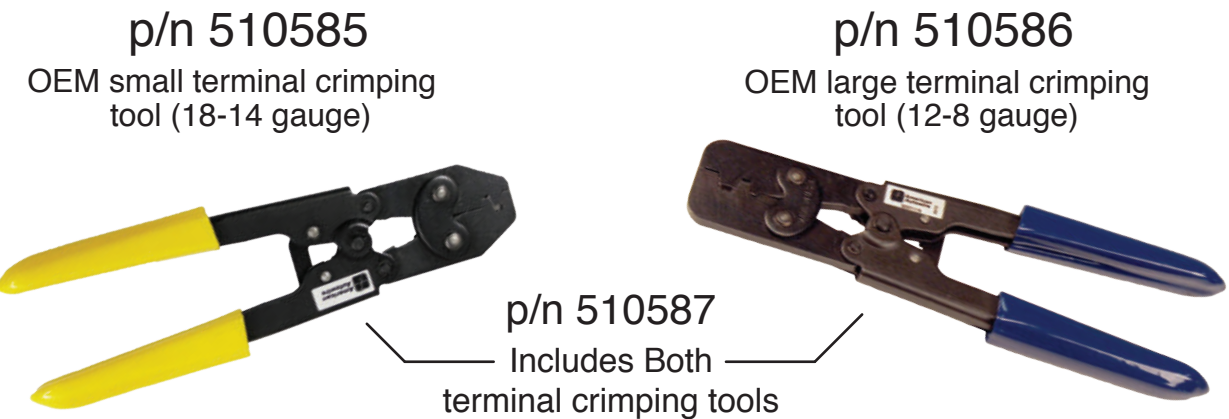

We carry many accessories for your 1968-76 Chevrolet Corvette:

p/n 01993430 (1968-76)
Muncie or T-10 4 speed
back-up lamp switch assembly



p/n 01997969 (1968-76) w/o telescopic wheel
p/n 01997983 (1968-76) with telescopic wheel
Turn signal switch assembly



p/n 01994169 (1968-76)
Windshield wiper/washer
switch assembly



STEP 1: DISCONNECT YOUR BATTERY:

Disconnect the battery before installing the wiring kit to prevent any accidental shorting caused by bare wire ends.



If you have any questions concerning this or any of our products, please feel free to call us at 1-856-933-0801.

STEP 2: START INSTALLING KIT:

This kit is broken into individual sections identified by a letter printed on the enclosed sheets visible through each bag. The order of installation and the pages with their instructions are shown below:

Table of Contents:

Bags: Pages: Sections:

G 4-10 Dash Harness - This is the main harness in the kit and contains:

- Ignition and lighting switch connections.
- Wiper switch connections.
- Neutral safety and back up lamp switch connections.
- Turn Signal switch connections.
- Courtesy light connections.
- Dimmer switch connection.
- Accessory connections.

H 11-14 Gauge Cluster Harness - This Harness contains:

- Gauge connections for aftermarket and factory gauges.

M 15-19 Rear Body Harness - This Harness contains:

- Brake, turn signal, reverse, running and side marker light connections.
- Third brake light and license plate lights connections.
- rear compartment and dome courtesy connections.
- Fuel gauge sender and ground connection.
- Chassis grounds.

L 20-23 Front Light Harness - This Harness contains:

- Headlight, turn signal, running and side marker light connections.
- Headlight door warning lamp connections.
- Brake pressure differential warning connection.
- Wiper door limit switch connections.
- Electric fan relay trigger.
- Horn connections.
- Chassis grounds.

J 24-26 Engine Harness - This Harness contains:

- Temperature, oil pressure, tachometer wiring.
- Blower motor power and ground connections.
- Windshield wiper and washer connections.
- Ignition and electric tach connections.
- '73-'75 cold air hood door connection.
- Alternator connections.
- Electric Choke connection.
- T-400 kickdown connection.



www.americanautowire.com 856-933-0801

PLEASE READ THIS HELPFUL INSTALLATION TIP, BEFORE GOING ANY FURTHER!

Prior to installing the Dash/Main harness in your dashboard, plug all of the fuses, Hazard Flasher and Turn Flasher into the Fuse Block (see detailed picture below) and the Horn Relay into this harness (see detailed picture below).

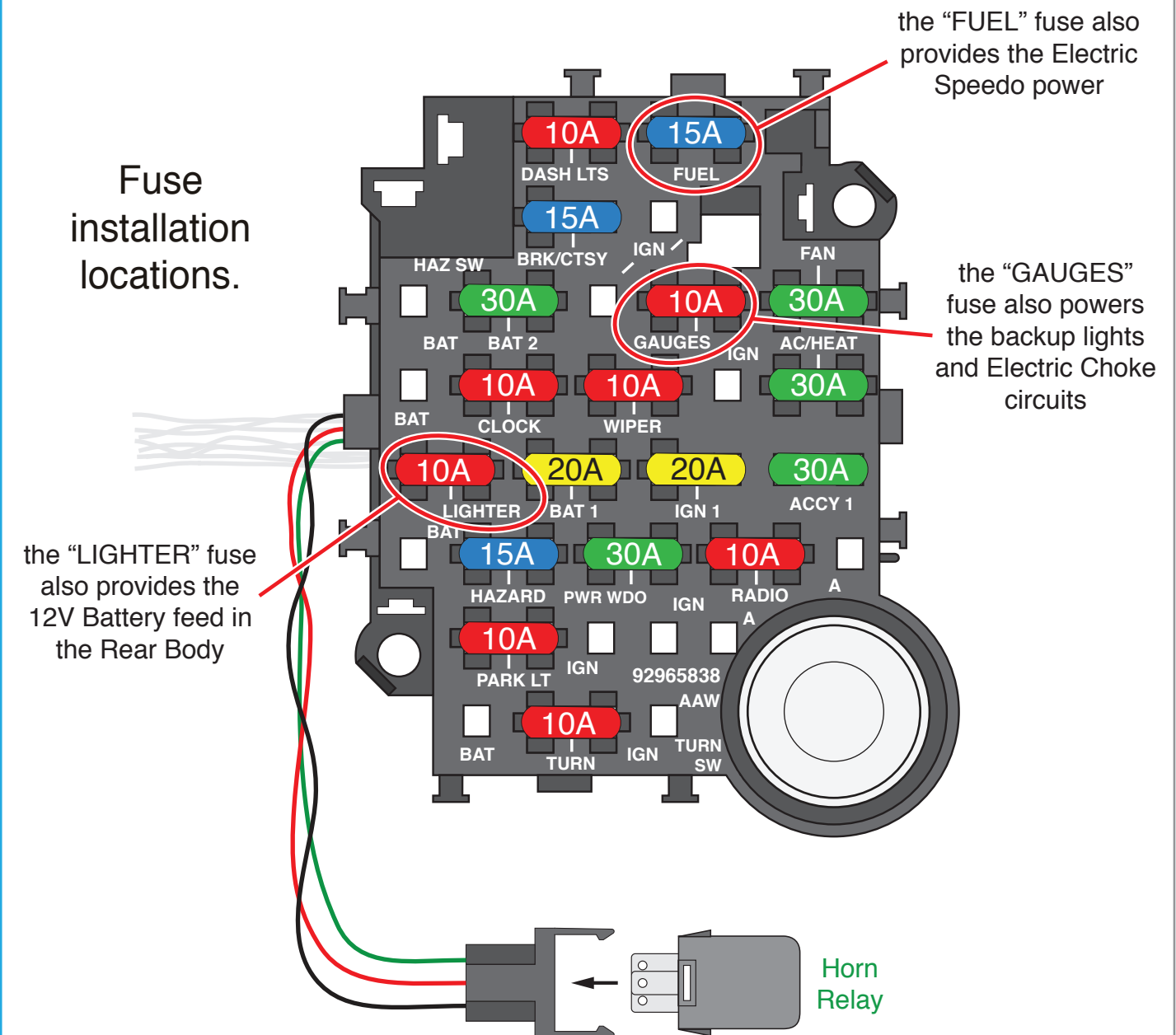

1968-76 Corvette

Classic Update Series

510717 92972159 Rev 5.0 1/26/2021

Dash/Main harness installation instructions:

Shown below are the supplied misc. terminals, plastic connector bodies, hardware, jumpers and extensions that will be used to complete your 510718 Dash/Main harness connections. They are itemized and referred to on this page, just as they are on the following pages of this Main instruction set.

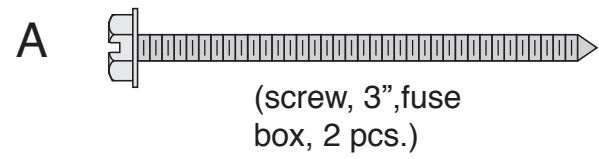

(screw, 3", fuse box, 2 pcs.)



(male flat Pack-con terminal, 11 pcs.)

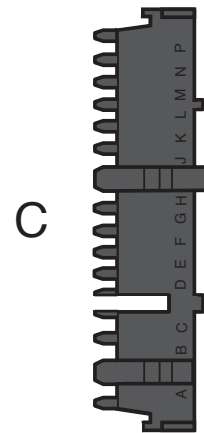

(Pack-con 14-way male connector, 1 pc.)



(56 series double female and large gauge terminal, 6 pcs.)

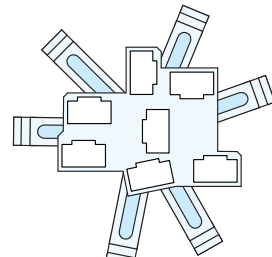
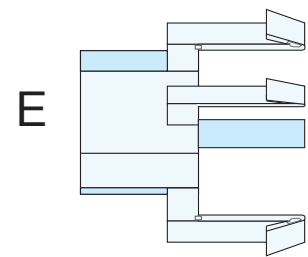

(56 Series 6-way female conn for 1968 ignition switch, 1 pc.)



(56 Series 2-way female conn for B/U switch, 1 pc.)



(56 series single female small gauge terminal, 10 pcs.)



(56 Series 1-way female connector for 70-76 cigar lighter, 1 pc.)



(pin grip connector for 68-69 cigar lighter, 1 pc.)



(pin grip terminal for 68-69 cigar lighter, 2 pcs.)

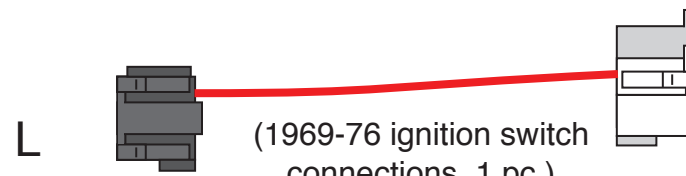

(1969-76 ignition switch connections, 1 pc.)

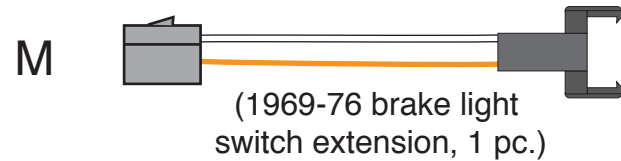

(1969-76 brake light switch extension, 1 pc.)

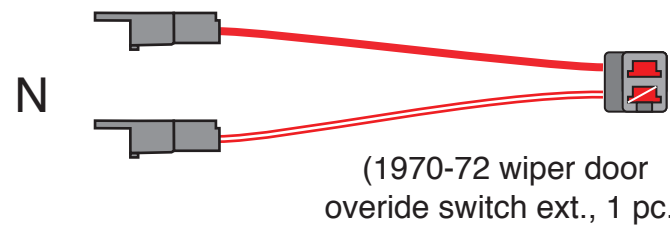

(1970-72 wiper door override switch ext., 1 pc.)

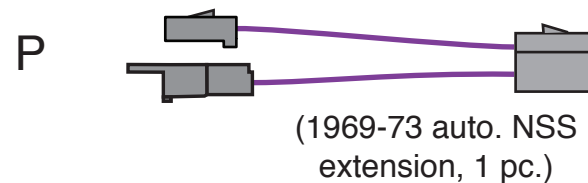

(1969-73 auto. NSS extension, 1 pc.)

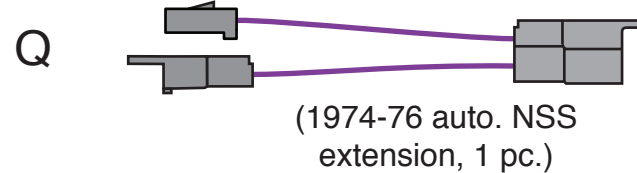

(1974-76 auto. NSS extension, 1 pc.)

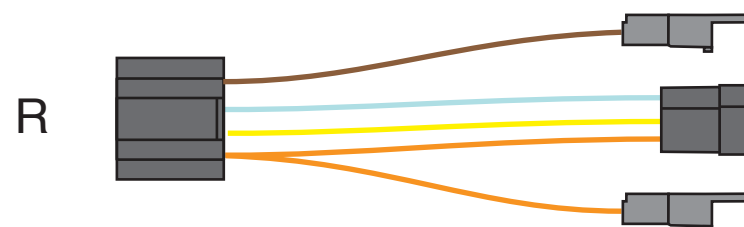

(1968-74 heater harness, 1 pc.)

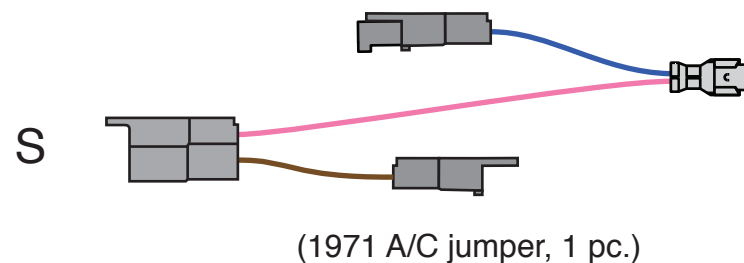

(1971 A/C jumper, 1 pc.)

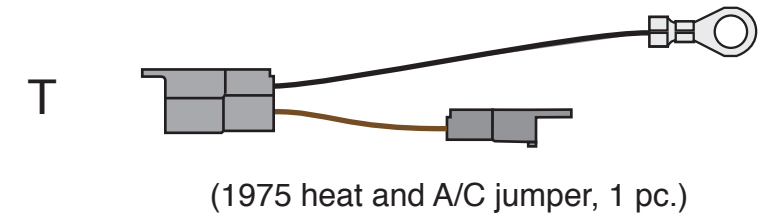

(1975 heat and A/C jumper, 1 pc.)

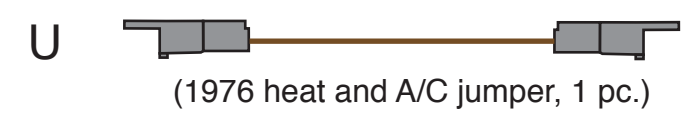

(1976 heat and A/C jumper, 1 pc.)

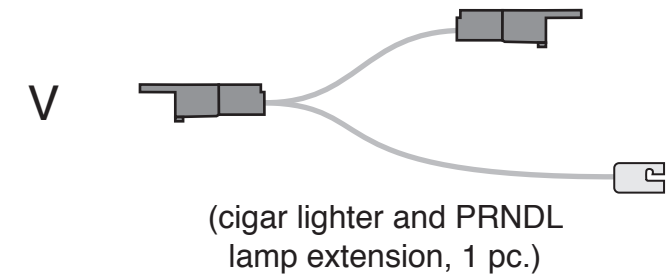

(cigar lighter and PRNDL lamp extension, 1 pc.)

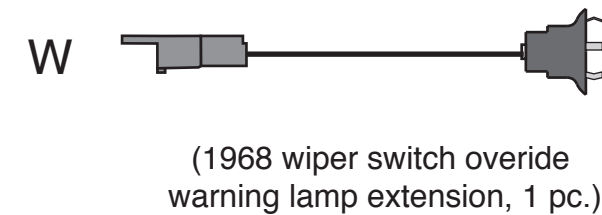

(1968 wiper switch override warning lamp extension, 1 pc.)

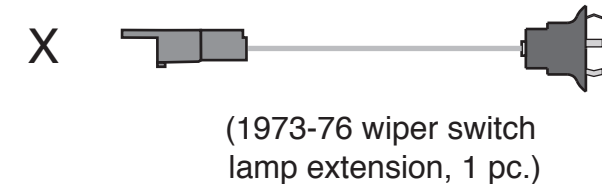

(1973-76 wiper switch lamp extension, 1 pc.)

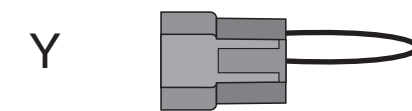

(1973-76 wiper relay jumper, 1 pc.)

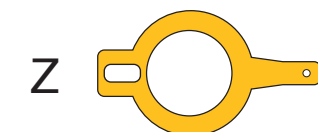

(76 cigar lighter ground terminal, 1 pc.)



www.americanautowire.com 856-933-0801

1968-76 Corvette

Classic Update Series

510717 92972159 Rev 5.0 1/26/2021

Dash/Main harness installation instructions:

NOTE: all 4 of the ground leads shown across the top of this page are to be attached to the upper bird cage crossbar behind the dash.

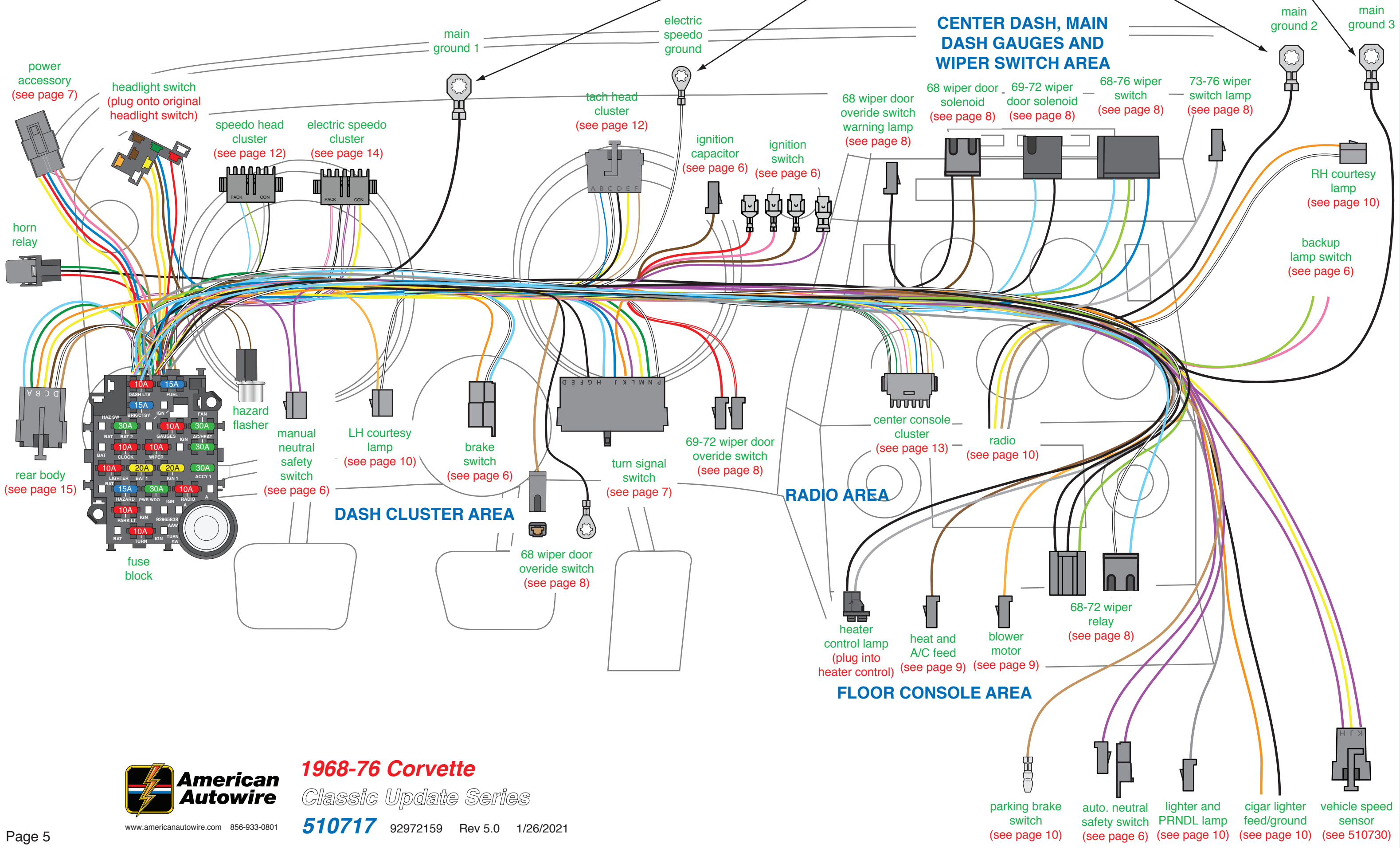

1968-76 Corvette
Classic Update Series
510717 92972159 Rev 5.0 1/26/2021

Dash/Main harness installation instructions:

1968 Ignition switch connection:

Choose the 1968 ignition switch connector E from page 4. Looking into the back of the connector, install the purple, red, pink and brown ignition switch wires from page 5 of the dash harness into the the selected cavities as shown in the detail drawing below. The completed connector assembly will plug directly onto your original, or new, ignition switch assembly.

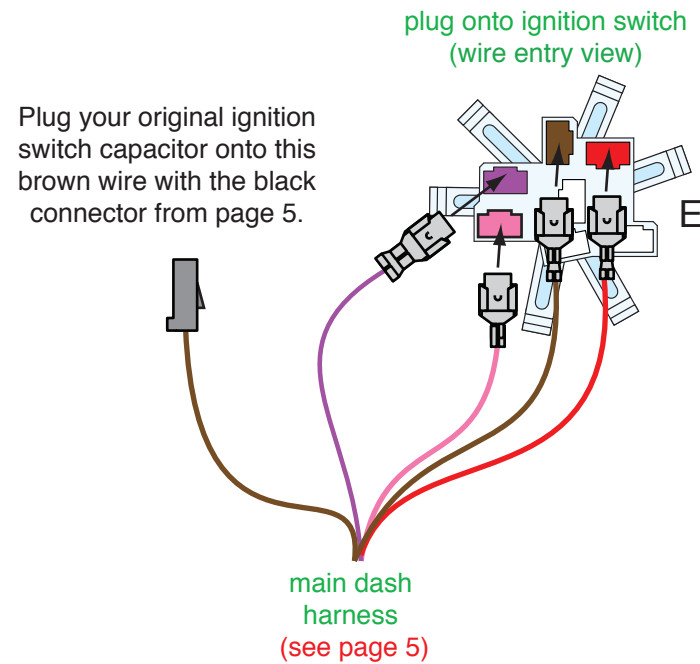

Brake light switch connections:

1968 application: The 1968 Corvette brake light switch had an extension hard-wired into the switch assembly that will plug directly into the brake switch connector on your dash harness.

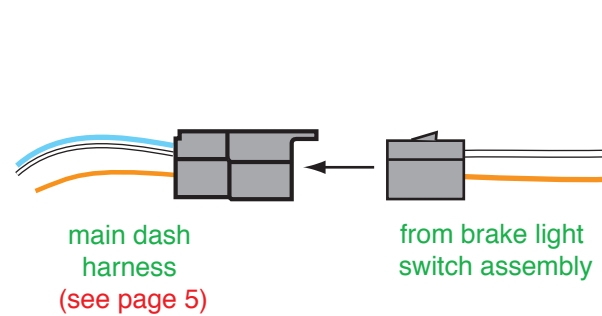

1969-76 applications: Choose the 1969-76 brake light switch extension M from page 4, and plug it into the brake switch connector on your dash harness. Plug the other end onto your 1969-76 brake light switch.

to brake light switch

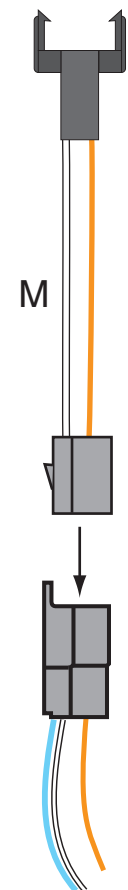

main dash harness (see page 5)

Neutral safety switch (NSS) instructions:

1968 w/ manual trans.: There was no NSS on a 1968 Corvette with a manual transmission. If your car has a manual transmission and you are not using an NSS, simply plug the 2 purple wires on page 5 down at the floor console area together as shown below.

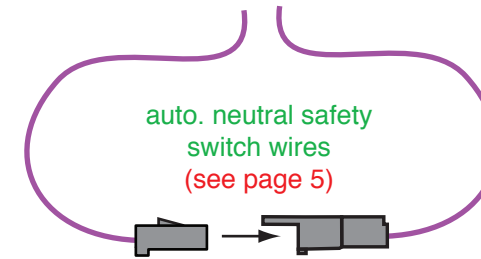

1968 w/ auto. trans.: Simply plug the 2 purple wires on page 5 down at the floor console area into your original 1968 NSS assembly.

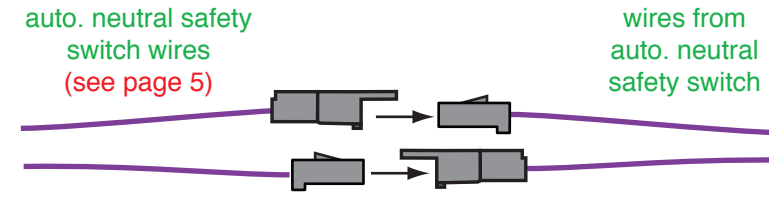

1969-76 w/ manual trans.: There was clutch operated NSS and extension lead on all 1969-76 Corvettes with a manual trans. Plug that extension lead onto the connector with the 2 purple wires in the dash cluster area on page 5. If your car has a manual transmission and you are not using an NSS, simply plug the 2 purple wires on page 5 down at the floor console area together as shown above (1968 app.).

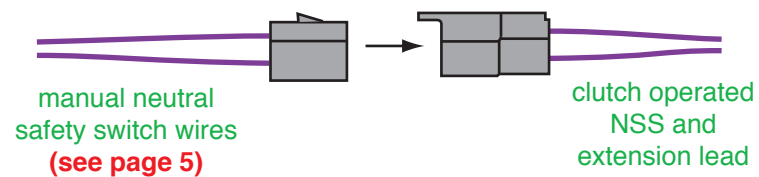

1969-76 w/ auto. trans.: Plug the 2 purple wires on page 5 down at the floor console area into the proper P or Q extension (from page 4) for your application, then plug that extension onto your 1969-73 or 1974-76 NSS assembly.

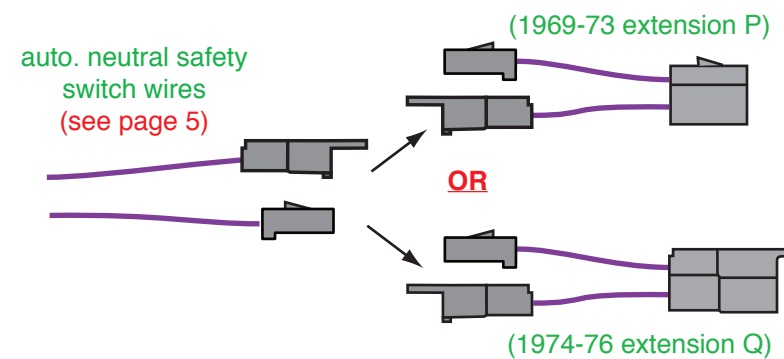

Back-up lamp switch instructions:

Choose the backup lamp switch connector F and terminals G from page 4, crimp terminal G onto each of the pink and light green backup lamp switch wires from page 5 of the dash harness. Looking into the back of the connector, install the two wires into the the selected cavities as shown in the detail drawing below.

4 speed application: Route this connector out through the firewall and plug it directly into the lead on the 4 speed backup lamp switch assembly.
auto. trans. application: Route this connector down to the console area and plug it directly into the lead on the neutral safety/backup lamp switch assembly.

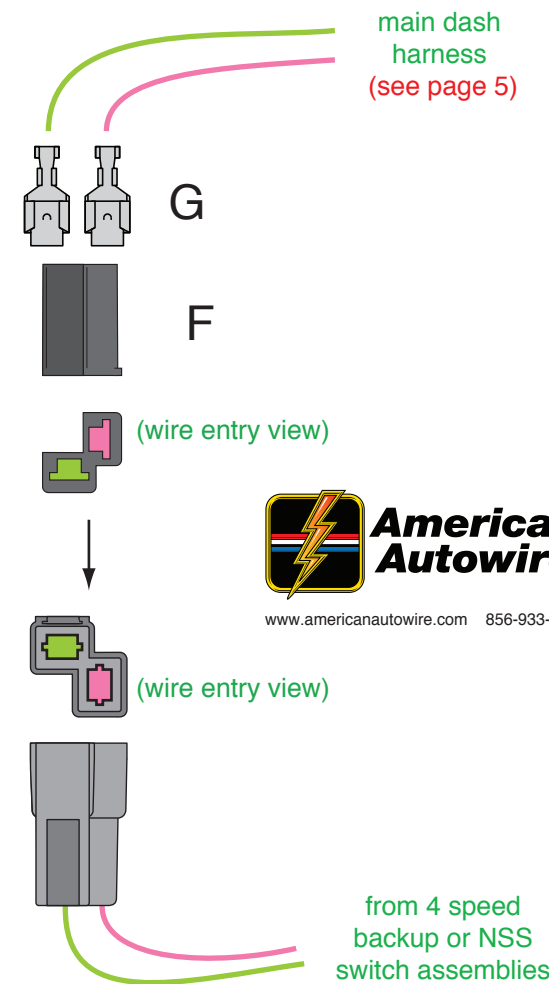

1968-76 Corvette
Classic Update Series
510717 92972159 Rev 5.0 1/26/2021

Dash/Main harness installation instructions:

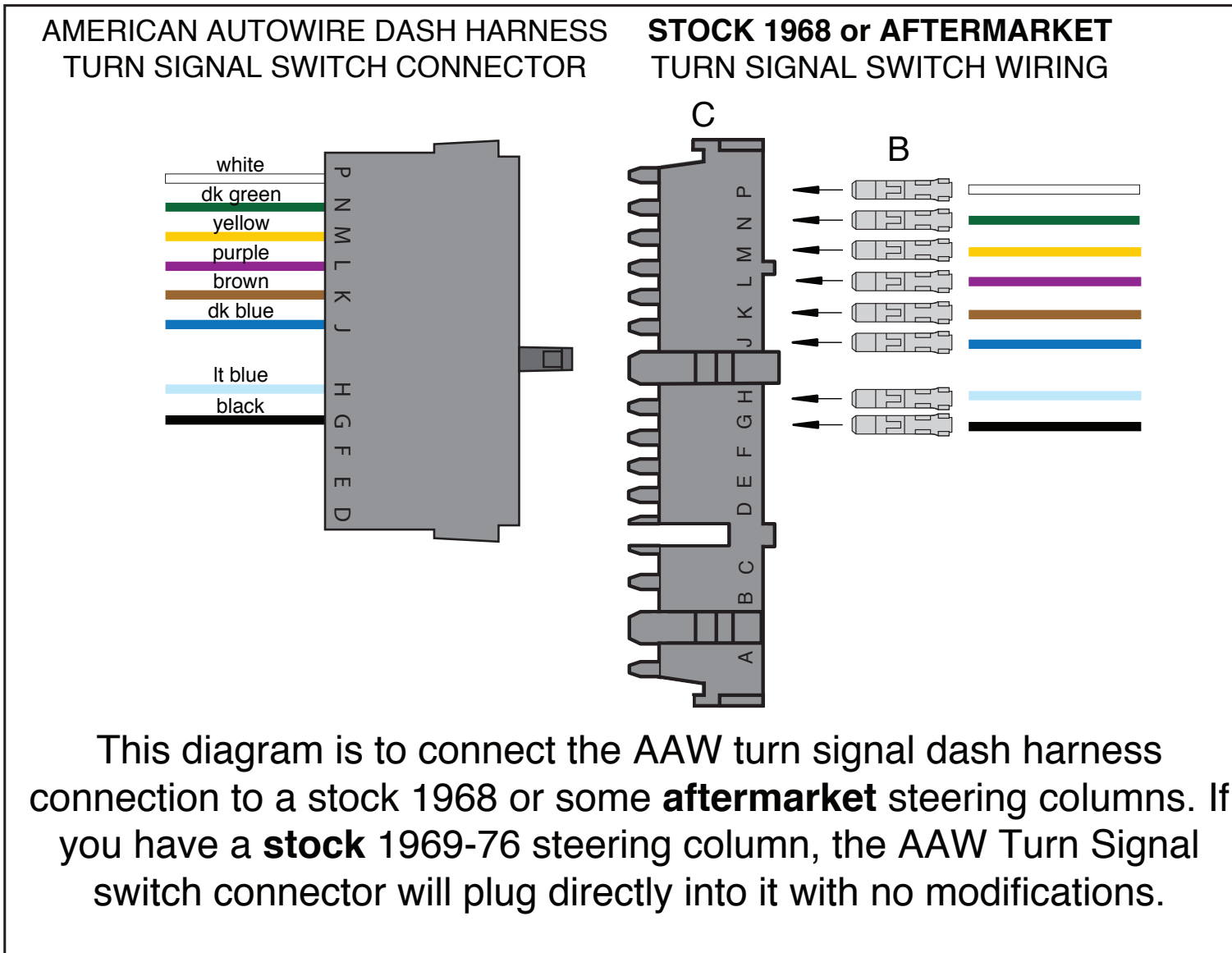

Required steering column connector modification for OEM and some aftermarket steering columns

“Table B”

Dash harness turn signal switch wires to aftermarket or stock 1968 Chevrolet Corvette turn signal switch

AAW Wire Color	AAW Wire Printing	Connector Cavity	Original Wire Color
White	Brake SW	P	White
Dark Green	Right Rear Turn	N	Dark Green
Yellow	Left Rear Turn	M	Yellow
Purple	Turn Switch Feed	L	Purple
Brown	Turn SW – Hazard	K	Brown
Dark Blue	Right Front Turn	J	Dark Blue
Light Blue	Left Front Turn	H	Light Blue
Black	Horn Relay Ground	G	Black
N/A	None	F	Pink/Black Stripe
N/A	None	E	None
N/A	None	D	None

1. Remove the **aftermarket or stock 1968** turn signal switch connector and replace it with the AAW 14-way connector “**C**” from page 4. Crimp terminal “**B**” onto each of the original turn signal switch wires, and plug them into connector “**C**” as shown at left. (see parts kit **92972164**).
2. Use “**Table B**” above to align the wires.
3. Note: the steering column horn button switches ground for the horn relay, which then switches power to the horns.

Power Accessory Connector

Use the provided 6-way empty connector, which is attached to the 6-way Accessory connector on the Dash Harness, and terminals “**G**” and “**D**” to add power wires (**not included in kit**) for the following optional systems:

Wire Color	Fuse Block Marking	Fuse rating	Description
Tan	ACCY 1	30A	Fused 12 volt ACCESSORY feed.
Dk Blue	FUEL	15A	Fused 12 volt IGNITION feed can be used for fuel pump.
Orange	BAT 1	20A	Fused 12 volt BATTERY feed.
Pink	IGN 1	20A	Fused 12 volt IGNITION feed.
Yellow	PWR WDO	30A	Fused 12 volt ACCESSORY feed can be used for power windows.

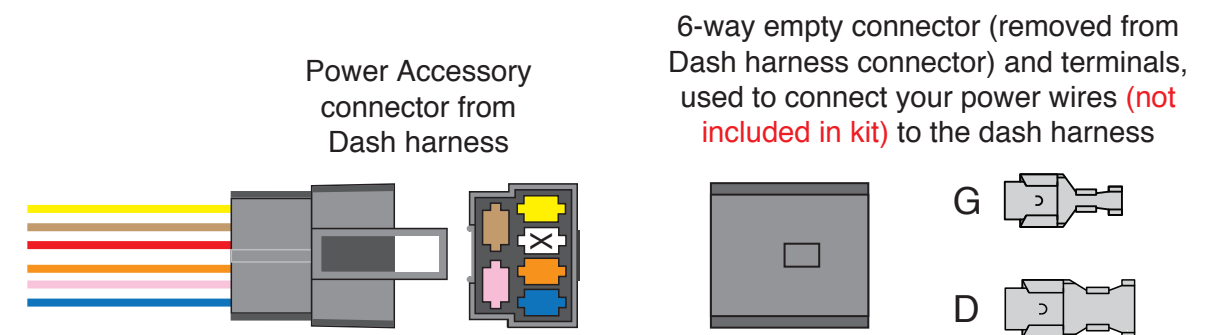

Dash/Main harness installation instructions:

68-72 wiper door override switch instructions:

1968 application: Plug the tan 1968 wiper door override wire from page 5 onto the wiper door override switch at the bottom of your dash. Attach the black ground wire under one of the mounting screws at the same location. Plug the warning lamp extension W onto the dash harness, then plug the lamp socket into your dash assembly.

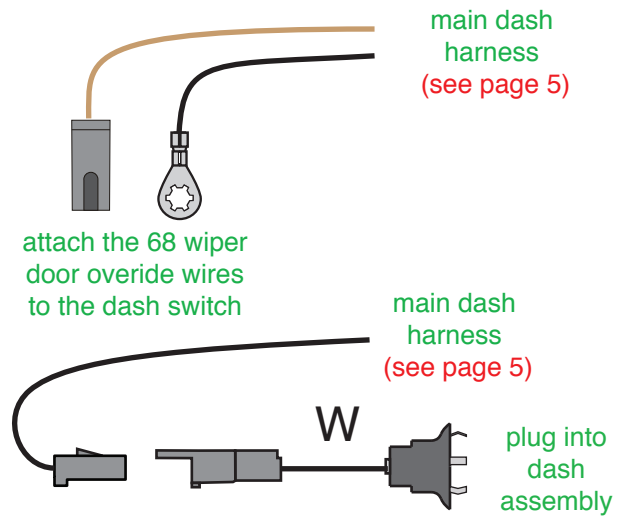

1969 application: Plug the red and red/white 1969 wiper door override wires from page 5 onto the wiper door override switch under the dash of your car.

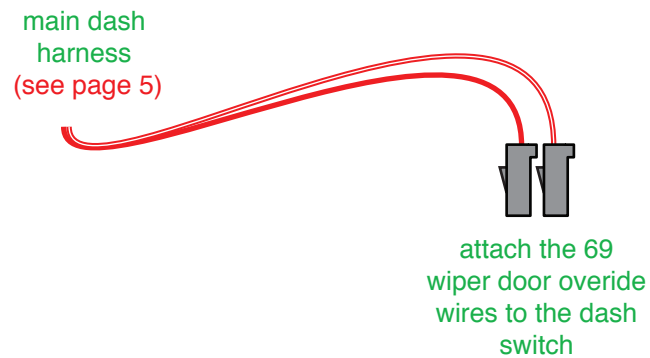

1970-72 applications: Plug the 1970-72 wiper door override switch extension N from page 4 onto the red and red/white 69 wiper door override switch wires on the dash harness, then plug the extension onto the wiper door override switch under the dash of your car.

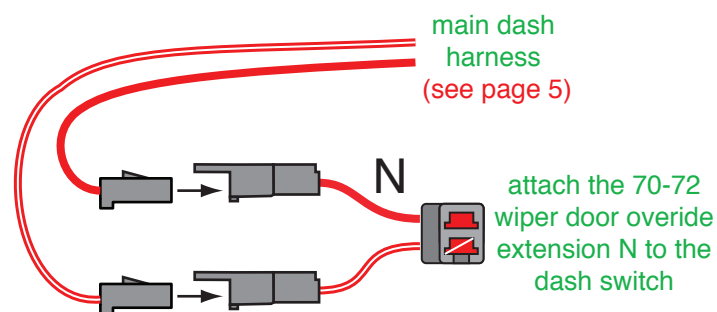

Wiper/washer switch instructions:

1968 application: Plug the 2-position connector with the black and brown wires onto the wiper door solenoid switch that is mounted behind the tach. Plug the 3-position connector with the light blue, light green and dark blue wires onto your wiper and washer switch.
NOTE: the 2-position connector with the light blue and white wires is not used in the 1968 application.

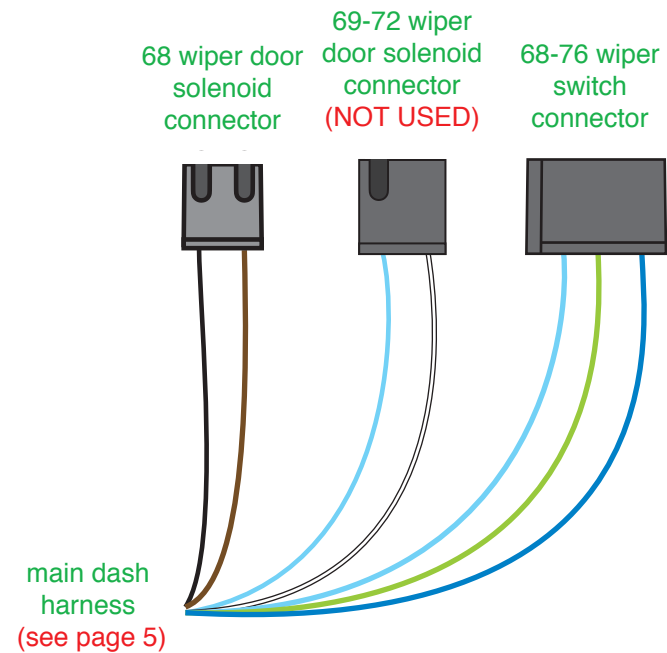

69-72 applications: Plug the 2-position connector with the light blue and white wires onto the wiper door solenoid switch that is mounted behind the tach. Plug the 3-position connector with the light blue, light green and dark blue wires onto your wiper and washer switch.
NOTE: the 2-position connector with the brown and black wires is not used in the 69-72 applications.

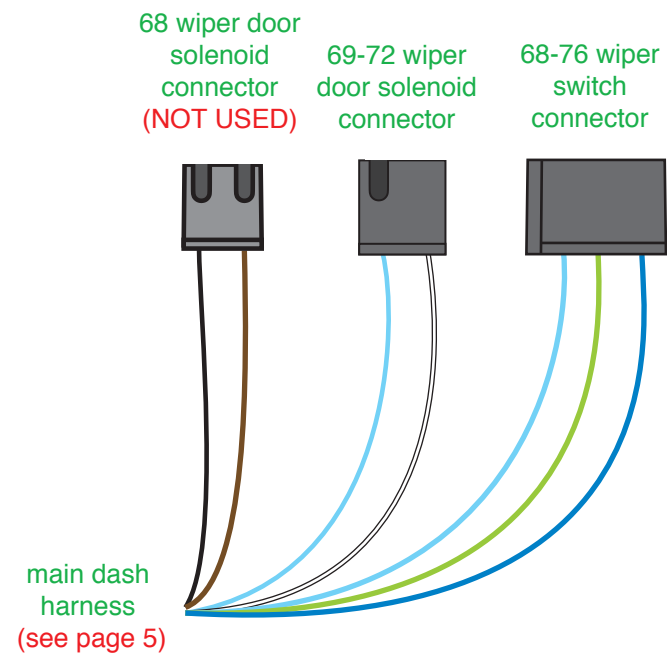

Wiper/washer switch instructions cont'd:

73-76 applications: Plug the 3-position connector with the light blue, light green and dark blue wires onto your wiper and washer switch.

NOTE: The 2-position connectors with the brown and black wires, and the light blue and white wires are not used in the 73-76 applications.

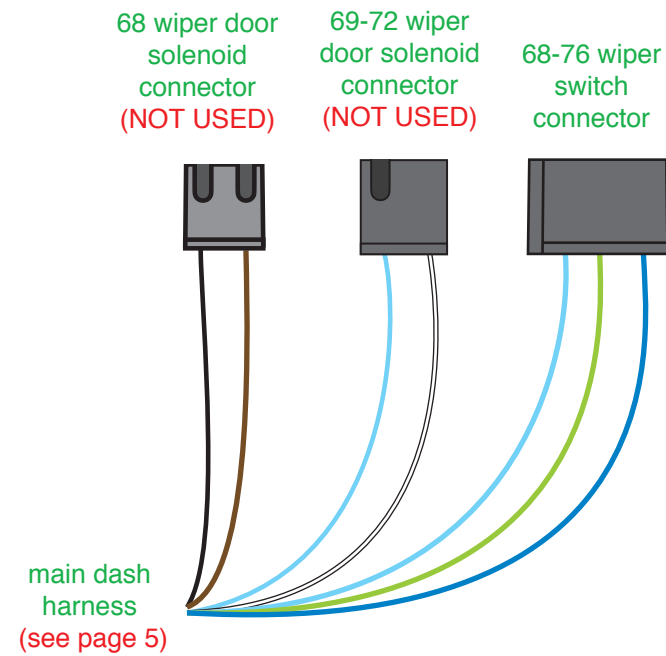

Wiper/washer relay instructions:

68-72 applications: Plug the 3-position connector with the light green and 2 black wires, and the 2-position connector with the light blue and white wires onto your wiper and washer relay down in the console area.

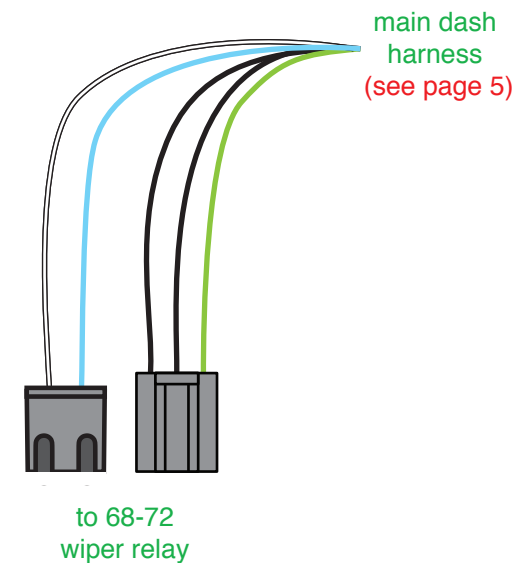

Wiper/washer relay instructions:

73-76 applications: There was no wiper/washer relay used in these applications. The 2-position connector with the light blue and white wires down in the console area will not be used. Choose the wiper relay jumper Y from page 4 and plug it onto the the 3-position connector with the light green and 2 black wires as shown below. This will jump out the wiper switch connector to work with the stock wiper motor.

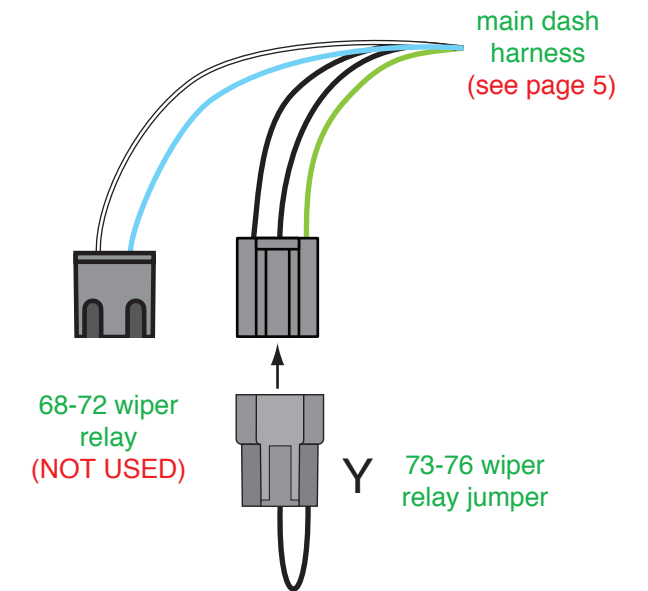

73-76 Wiper switch lamp instructions:

73-76 applications: Find the gray wire with the single black connector that comes out with the wiper switch connector and wires. Choose the 73-76 wiper switch lamp extension X from page 4 and plug it onto that gray wire to complete the 73-76 wiper switch lamp circuit.

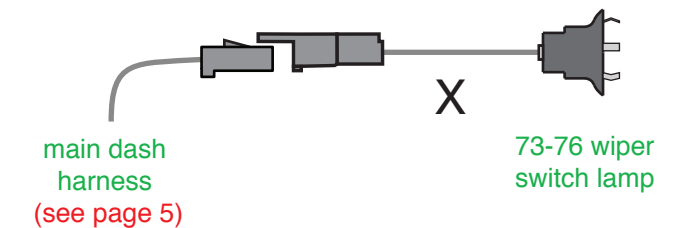

www.americanautowire.com 856-933-0801

1968-76 Corvette
Classic Update Series
510717 92972159 Rev 5.0 1/26/2021

Dash/Main harness installation instructions:

68-74 Heater harness instructions:

68-74 applications: Choose heater harness assembly R from page 4 and plug it into the brown (heat and A/C feed) and orange (blower feed) leads from the dash harness as shown below. The 6-position connector will then plug onto your heater/blower switch and the 3-position one will plug onto the blower motor resistor.

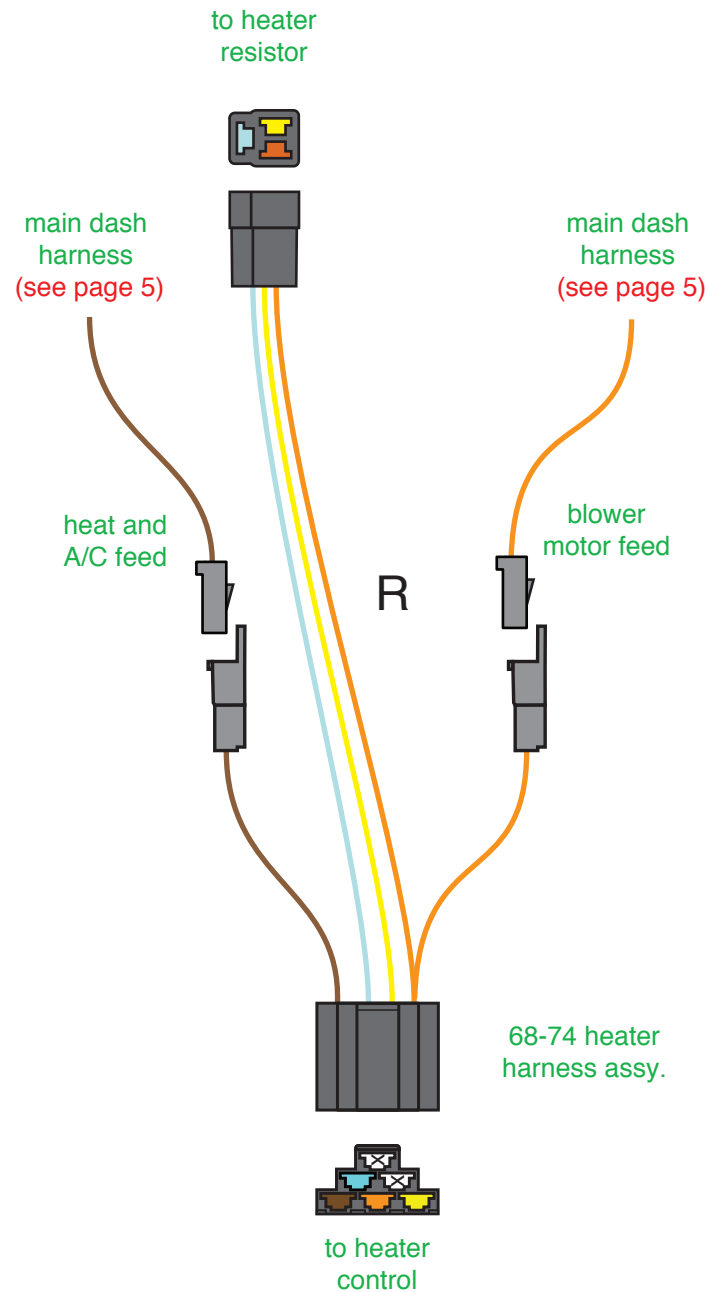

1975-76 Heat and A/C feed instructions:

1975 application: Choose the 1975 heat and A/C jumper T from page 4 and plug it into the brown (heat and A/C feed) lead from the dash harness as shown below. Plug the 2-position connector from jumper T into your stock heater or A/C harness. If your original heater harness needs to be replaced, you can order our P/N 01680. Attach the ring terminal on the black wire of jumper T to a good known chassis ground.

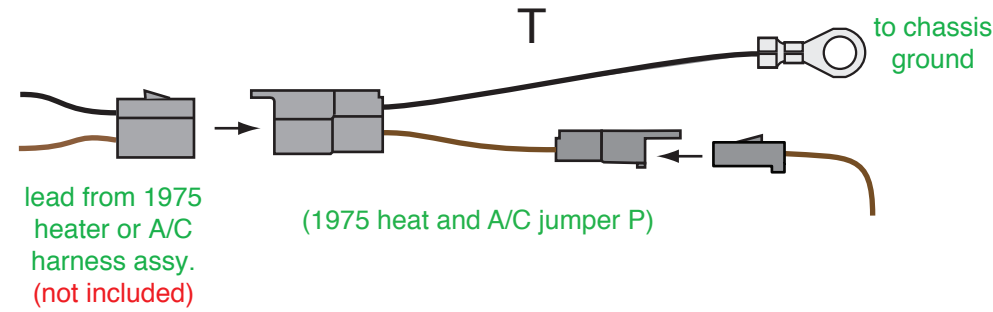

1976 application: Choose the 1976 heat and A/C jumper U from page 4 and plug it into the brown (heat and A/C feed) lead from the dash harness as shown below. Plug the other connector from the jumper U into your original heater or A/C harness. If your original heater harness needs to be replaced, you can order our P/N 27545.

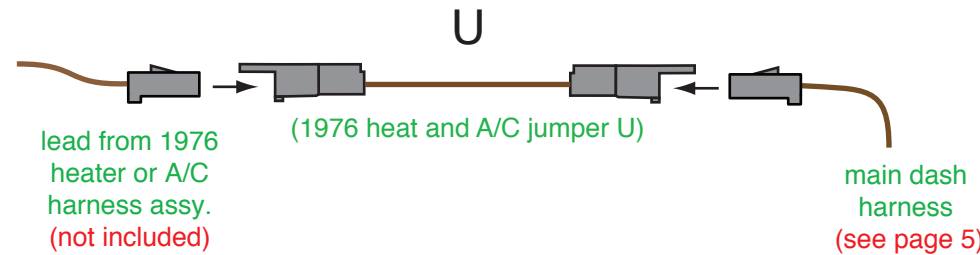

1971 A/C feed instructions:

1971 application: Choose the 1971 A/C jumper S from page 4 and plug it into the brown (heat and A/C feed) lead from the dash harness as shown below. Plug the bare terminal with the blue and pink wires into the power accessory plug on the dash harness (see pages 5 and 7). Be sure to maintain color continuity with the blue wire in the power accessory plug on the dash harness. Your factory A/C harness (01030) will plug into the 2-position plug on the 71 A/C jumper harness S as shown below.

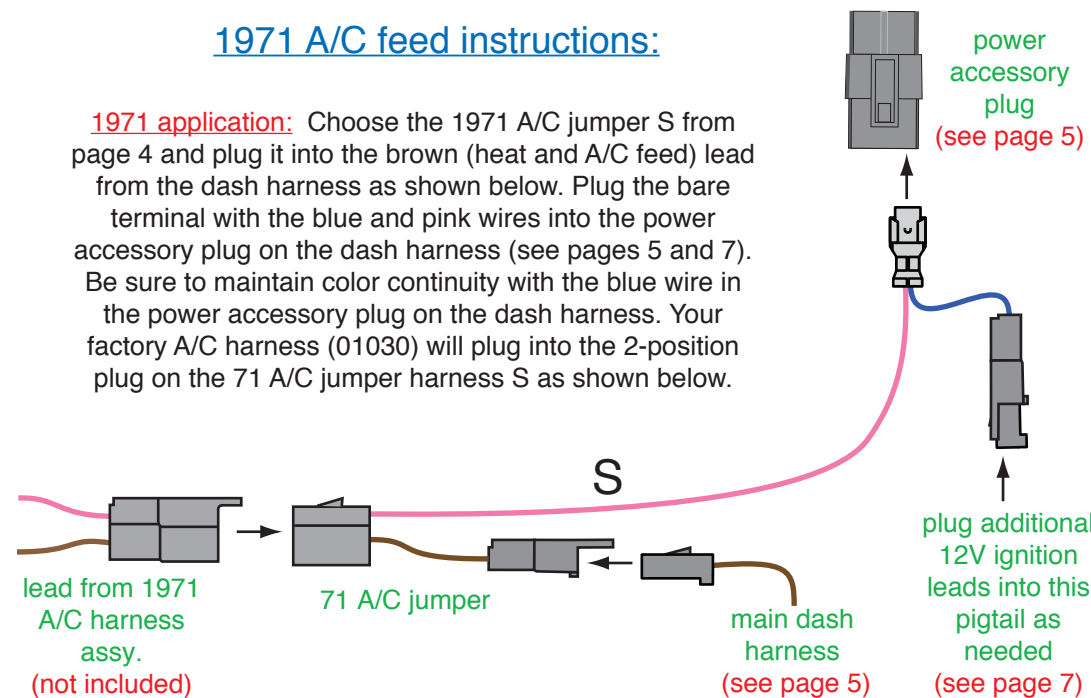

68-76 factory A/C instructions:

While this kit **DOES NOT** include the wiring for any 1968-76 factory A/C systems, it will support their use. All of the factory 1968-76 A/C harnesses were stand alone units, and can be re-used with your new AAW Classic Update Kit if desired. In addition, AAW offers new factory A/C harnesses at an additional cost for each of the individual years covered by this kit (please see the list below). You would simply plug the brown heat and A/C feed wire from page 5 of this instruction set (for the 68, 69, 70, 72, 73 and 74 models) into your factory A/C harness to power it up. For the 71, 75 and 76 models, please refer to the detailed connections to the left on this page. **The only additional connection that must be made is to connect the fused red lead on the factory A/C harness to a battery source under the hood of the car.**

AAW Factory A/C harnesses:

- | | |
|------------|---------------|
| 1. 1968 | AAW P/N 01015 |
| 2. 1969-70 | AAW P/N 01020 |
| 3. 1971 | AAW P/N 01030 |
| 4. 1972-73 | AAW P/N 01035 |
| 5. 1974 | AAW P/N 01045 |
| 6. 1975 | AAW P/N 01050 |
| 7. 1976 | AAW P/N 27540 |



www.americanautowire.com 856-933-0801

1968-76 Corvette
 Classic Update Series
510717 92972159 Rev 5.0 1/26/2021

Dash/Main harness installation instructions:

Parking brake instructions:

68-76 applications: Route the tan wire from page 5 down to the console area, then over to the parking brake assembly and plug the bullet terminal into the parking brake switch assembly.

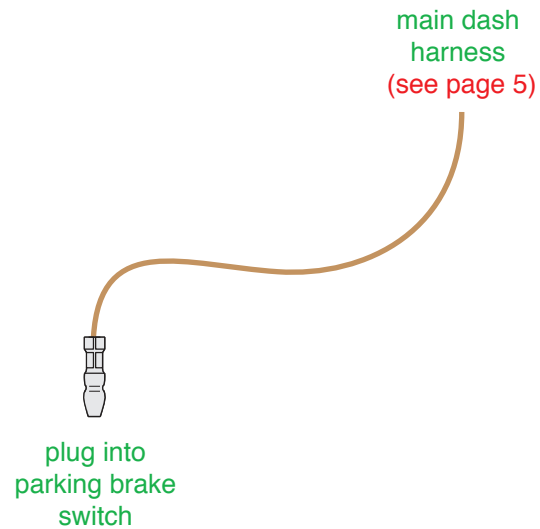

PRNDL and cigar lighter lamp instructions:

1968-76 applications: Route the gray PRNDL and cigar lighter lamp wire with the black connector from page 5 down to the console area and plug the cigar lighter and PRNDL lamp extension V onto it. Plug the light socket on extension V into the cigar lighter assembly. Plug the lead from your PRNDL lamp (not included) into the black connector on extension V

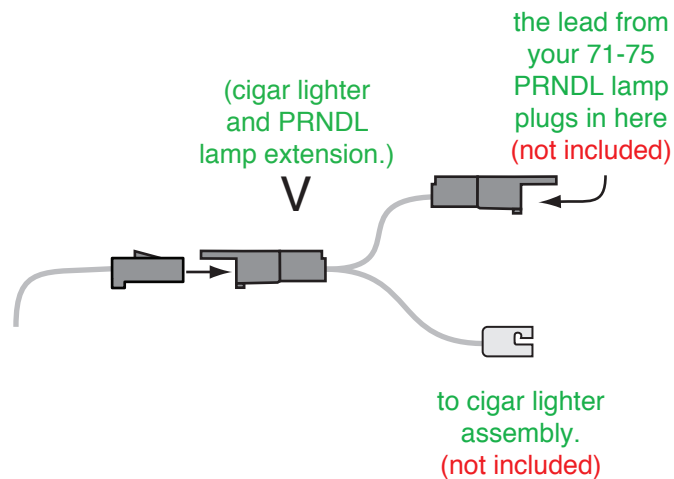

Cigar lighter instructions:

1968-69 applications: Route the orange cigar lighter power feed wire over to the lighter assembly in the console, trim it to length, apply terminal K and connector J to the wire, then plug connector J onto the stud of your cigar lighter assembly.

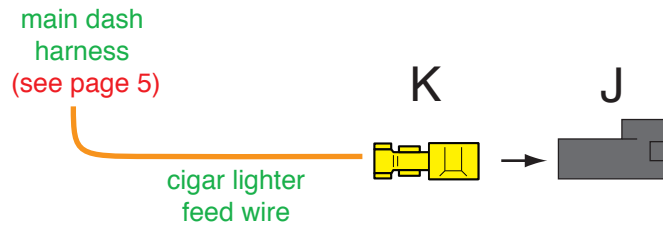

1970-76 applications: Route the orange cigar lighter power feed wire over to the lighter assembly in the console, trim it to length, apply terminal G and connector H to the wire, then plug connector H onto the male blade of your cigar lighter assembly.

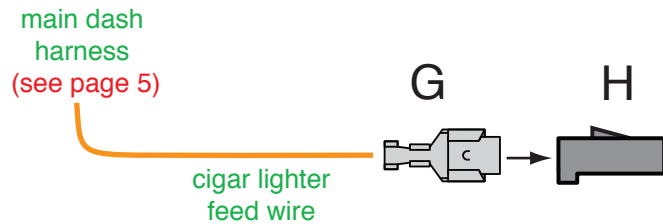

Console or lighter ground instructions:

1968-75 applications: Route the black console/cigar lighter ground wire over to the male blade terminal in the console, trim it to length and apply terminal G and plug it onto that male blade assembly.

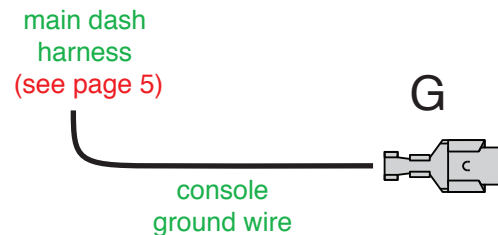

1976 applications: Route the black console/cigar lighter ground wire over to the lighter assembly in the console, trim it to length and apply terminal G to the black wire. Disassemble the lighter socket from the retainer assembly and install lighter ground ring terminal Z and reassemble the socket and retainer. Plug the black wire and terminal G onto terminal Z.

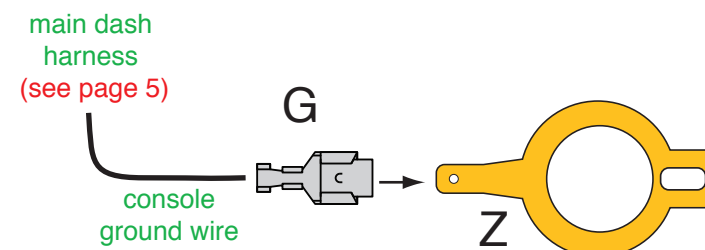

Underdash courtesy lamp instructions:

1968-76 applications: Plug the LH and RH courtesy lamp connections from the dash harness into the two courtesy lamp assemblies from the 510723 kit. Install the completed courtesy lamps up under the dash and route the white wires from the assemblies over to the original door jamb switches (not included) and plug the leads onto the switch assemblies.
NOTE: The courtesy lamp connections on this new harness are set up to mate to the later style (74-76) door jamb switch assemblies. If your car is a 68-73, you will need to purchase 2 new door jamb switches from your favorite Corvette supplier.

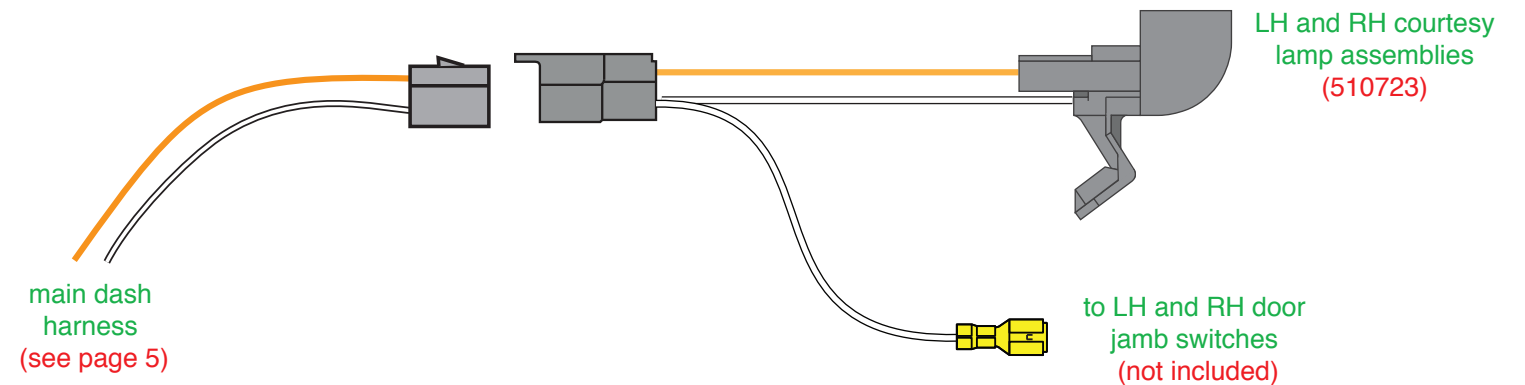

Radio connection instructions:

All applications:

We have provided the following wires for you to make connections to your radio.





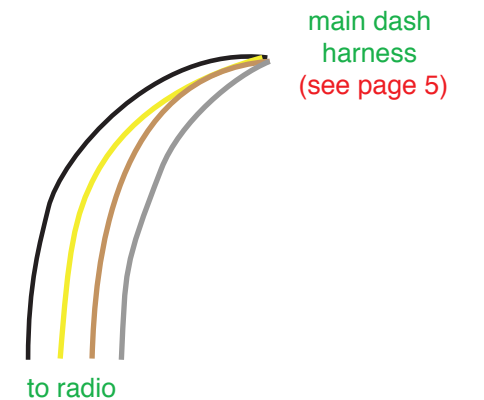



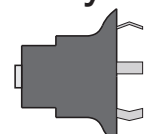
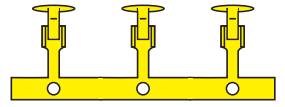
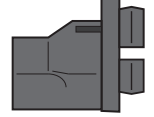

1. yellow "radio-battery" feed (12v hot for memory)
2. tan "radio" feed (12v switched on/off)
3. gray "dash lamps" feed (radio dial illumination)
4. black "ground"

You will need to splice these wires into your radio connection as needed as we have not provided terminals or connectors.

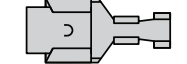
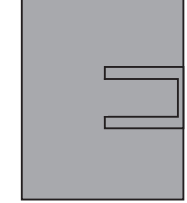

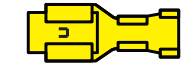
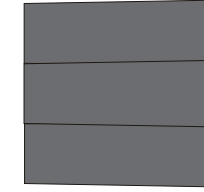
Dash Cluster harness installation instructions:

Shown below are the supplied misc. terminals, plastic connector bodies and hardware that will be used to complete your 510719 Cluster Kit connections. They are itemized and referred to on this page, just as they are on the following pages of this main instruction set.

- A  (single feed lamp socket, 17 pcs.)
- B  (lamp socket rivet terminal, 22 pcs.)
- C  (dual feed lamp socket, 2 pcs.)
- D  (spring for lamp socket C, 3 pcs.)
- E  (ground terminal for lamp socket C, 3 pcs.)
- F  (56 series single female connector, 3 pcs.)
- G  (56 series single wire female terminal, 10 pcs.)
- H  (56 series 3-postion female connector for temp gauge, 1 pc.)
- J  (56 series 2-postion female connector for fuel gauge, 1 pc.)
- K  (56 series double wire female terminal, 4 pcs.)
- L  (56 series 3-postion female connector for 74-76 oil gauge, 1 pc.)
- M  splice clip, 5 pcs.)
- N  (shrink tubing, 5 pcs.)
- P  (56 series 3-postion female connector for 76 only tach, 1 pc.)

How to use the splice clip to join multiple wires.

Below is just an **EXAMPLE** of how to use the splice clip and shrink tubing, see your specific application on the following pages for actual splice information.

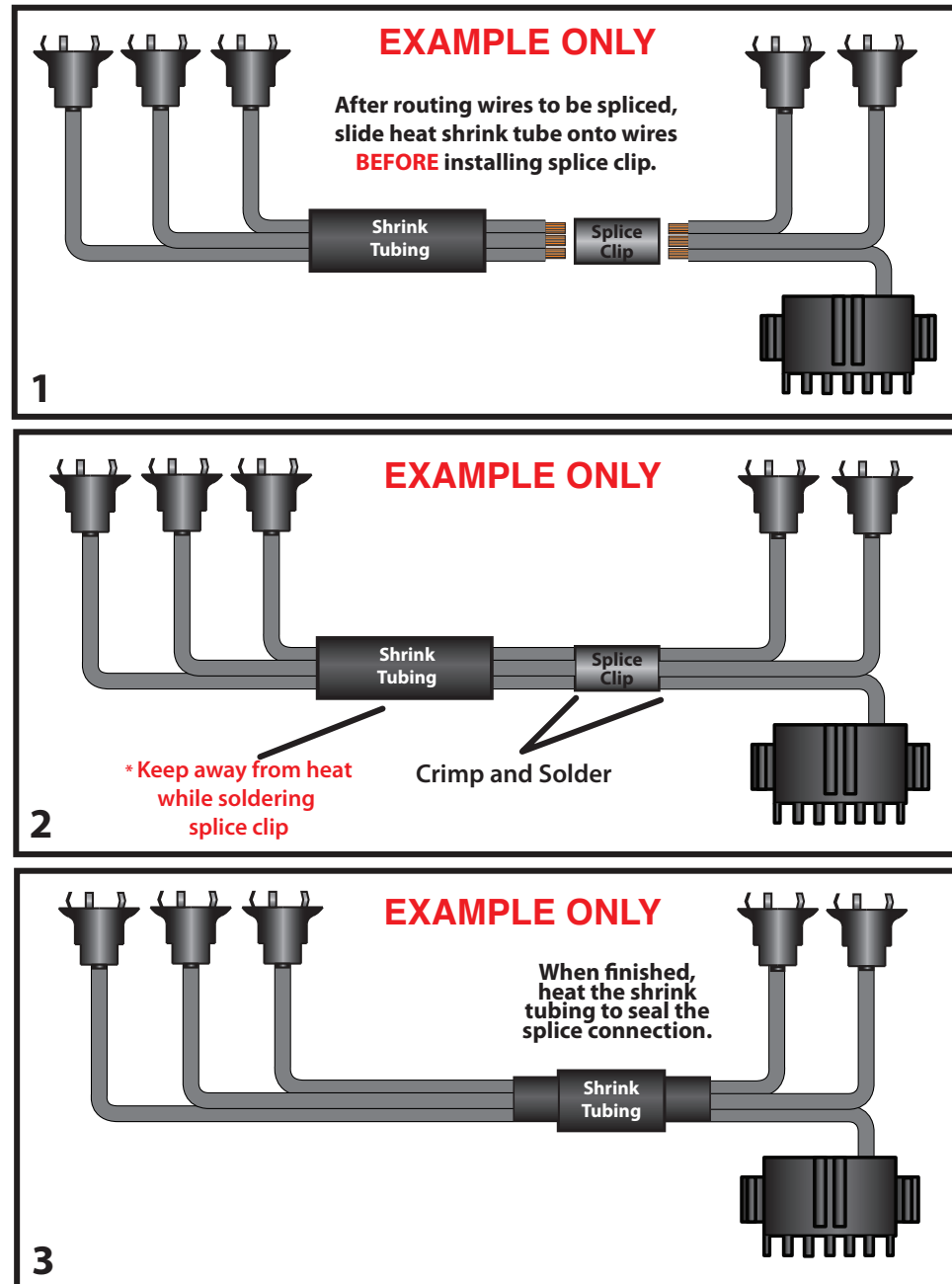

How to install lamp sockets and lamp socket terminals.

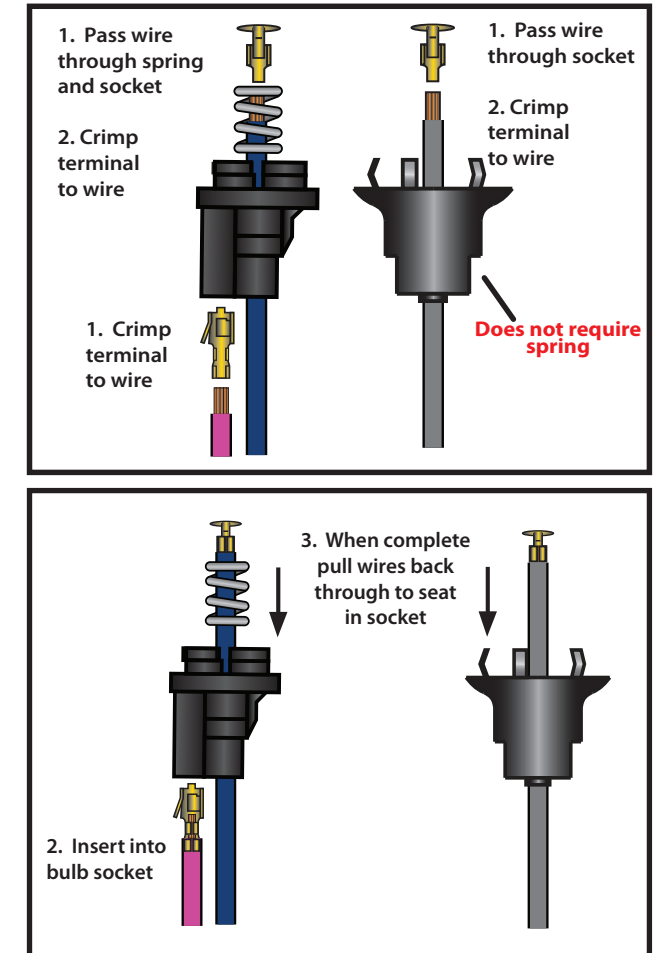

www.americanautowire.com 856-933-0801

1968-76 Corvette
 Classic Update Series
510717 92972159 Rev 5.0 1/26/2021

Instrument Cluster harness installation instructions:

Stock Tach and Speedo Cluster:



www.americanautowire.com 856-933-0801

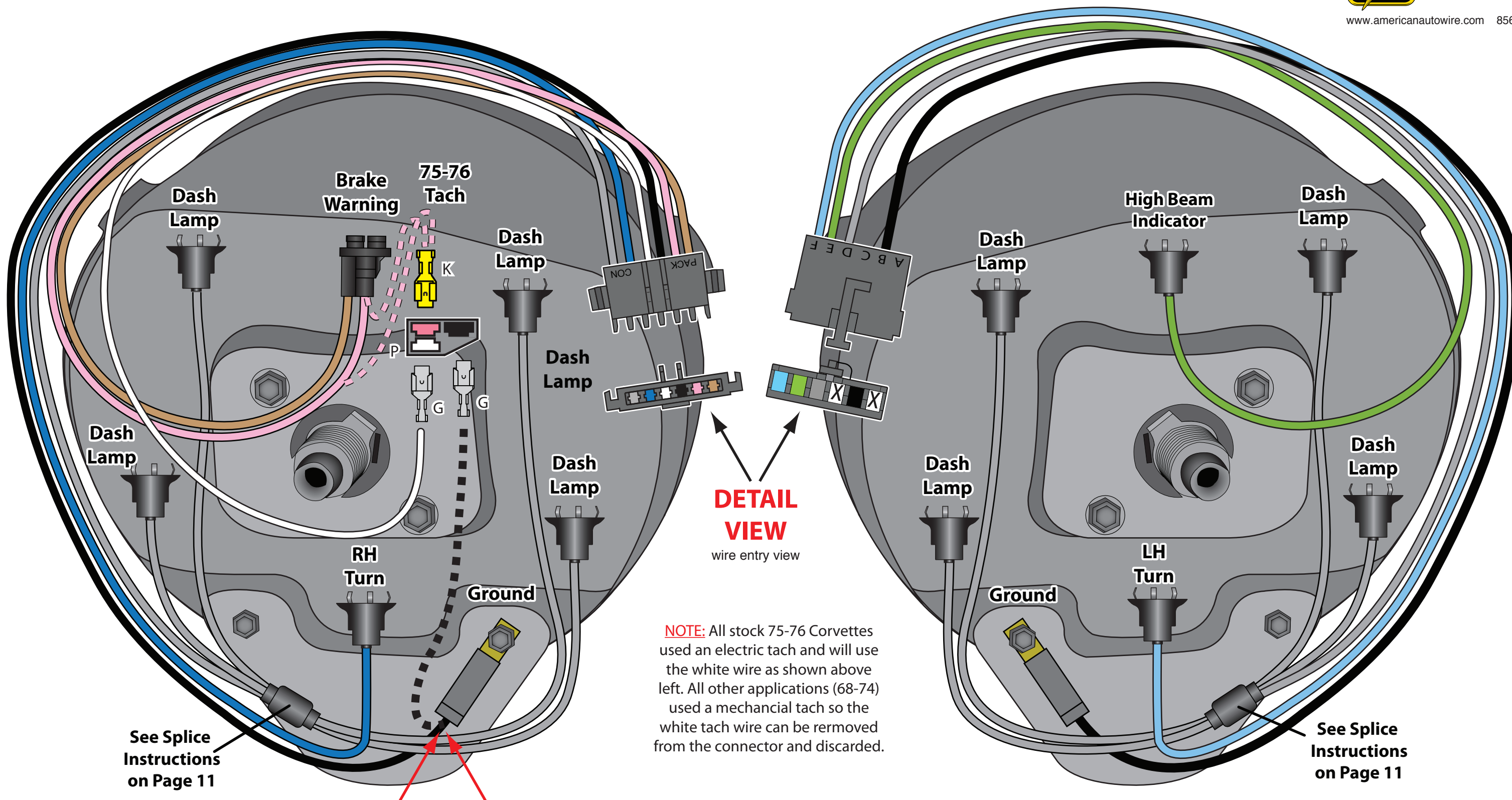

DETAIL VIEW
wire entry view

NOTE: All stock 75-76 Corvettes used an electric tach and will use the white wire as shown above left. All other applications (68-74) used a mechanical tach so the white tach wire can be removed from the connector and discarded.

See Splice Instructions on Page 11

See Splice Instructions on Page 11

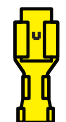
(all except 75-76 applications)  G or  K (75-76 applications only)

1968-76 Corvette
Classic Update Series
510717 92972159 Rev 5.0 1/26/2021

Instrument Cluster harness installation instructions:

Center Console Gauge Cluster:

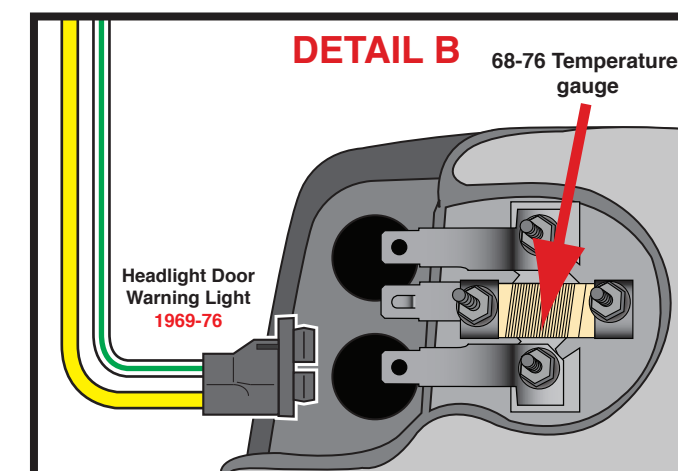
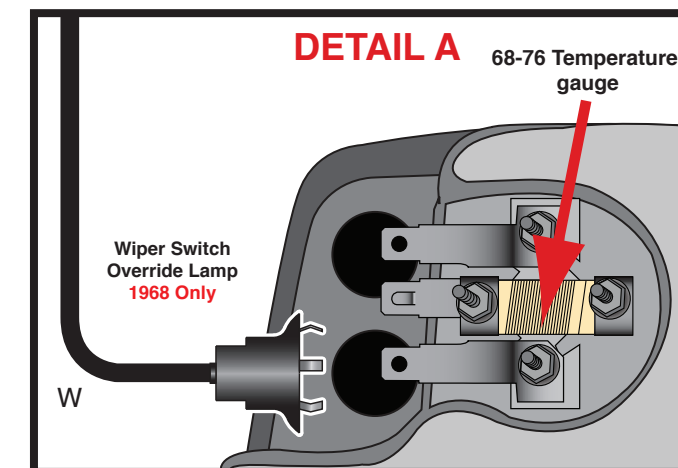
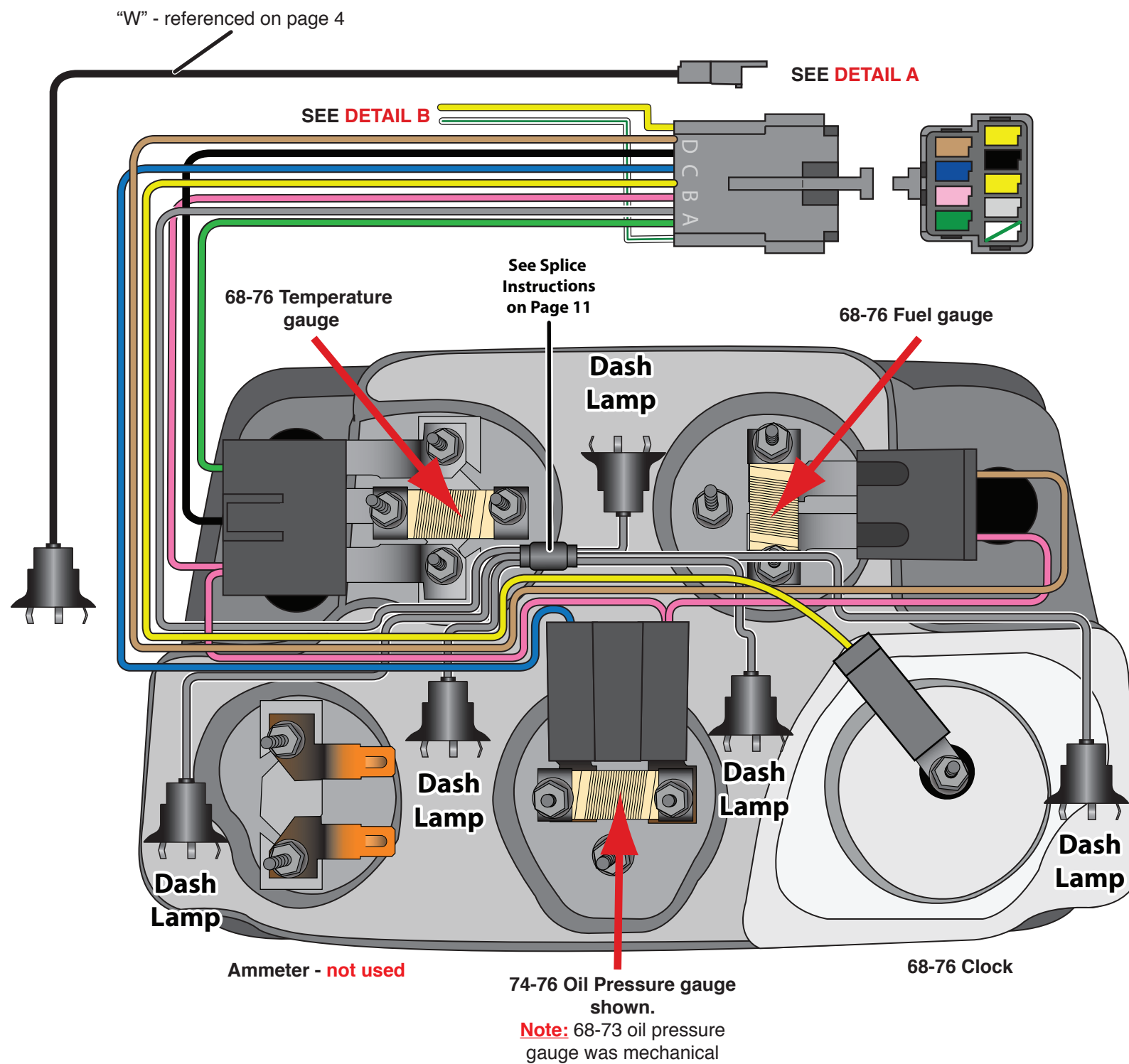
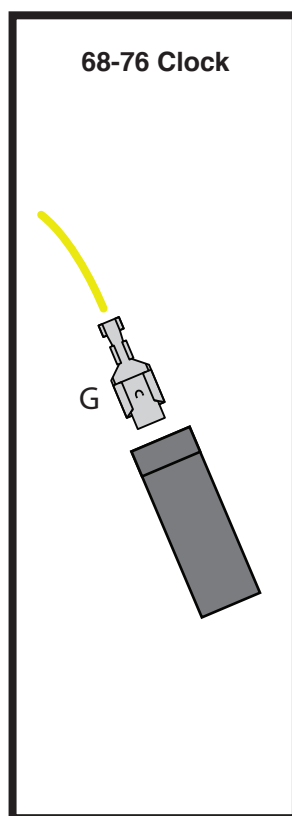
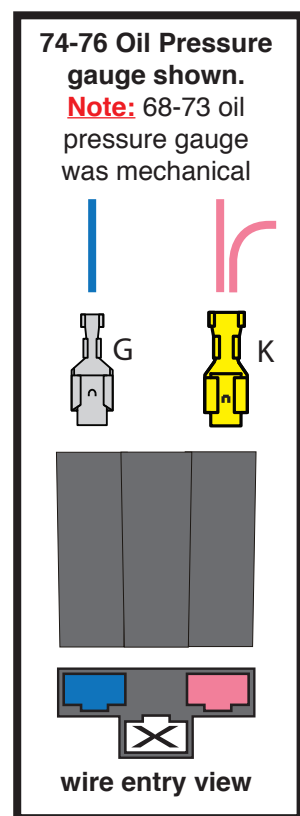
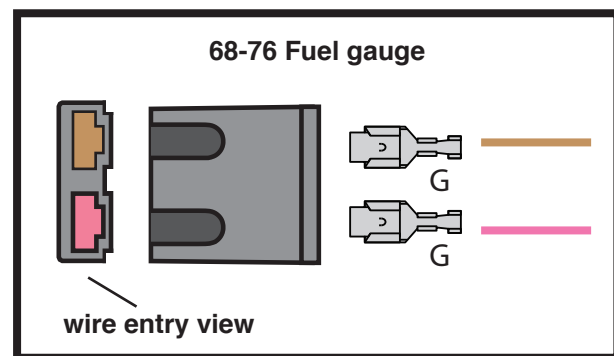
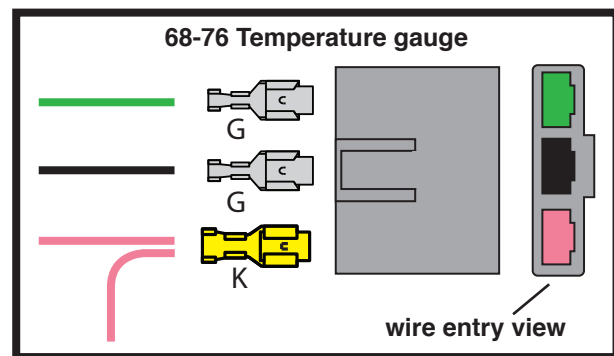

www.americanautowire.com 856-933-0801

1968-76 Corvette
 Classic Update Series

510717 92972159 Rev 5.0 1/26/2021

Instrument Cluster harness (aftermarket gauges) installation instructions:

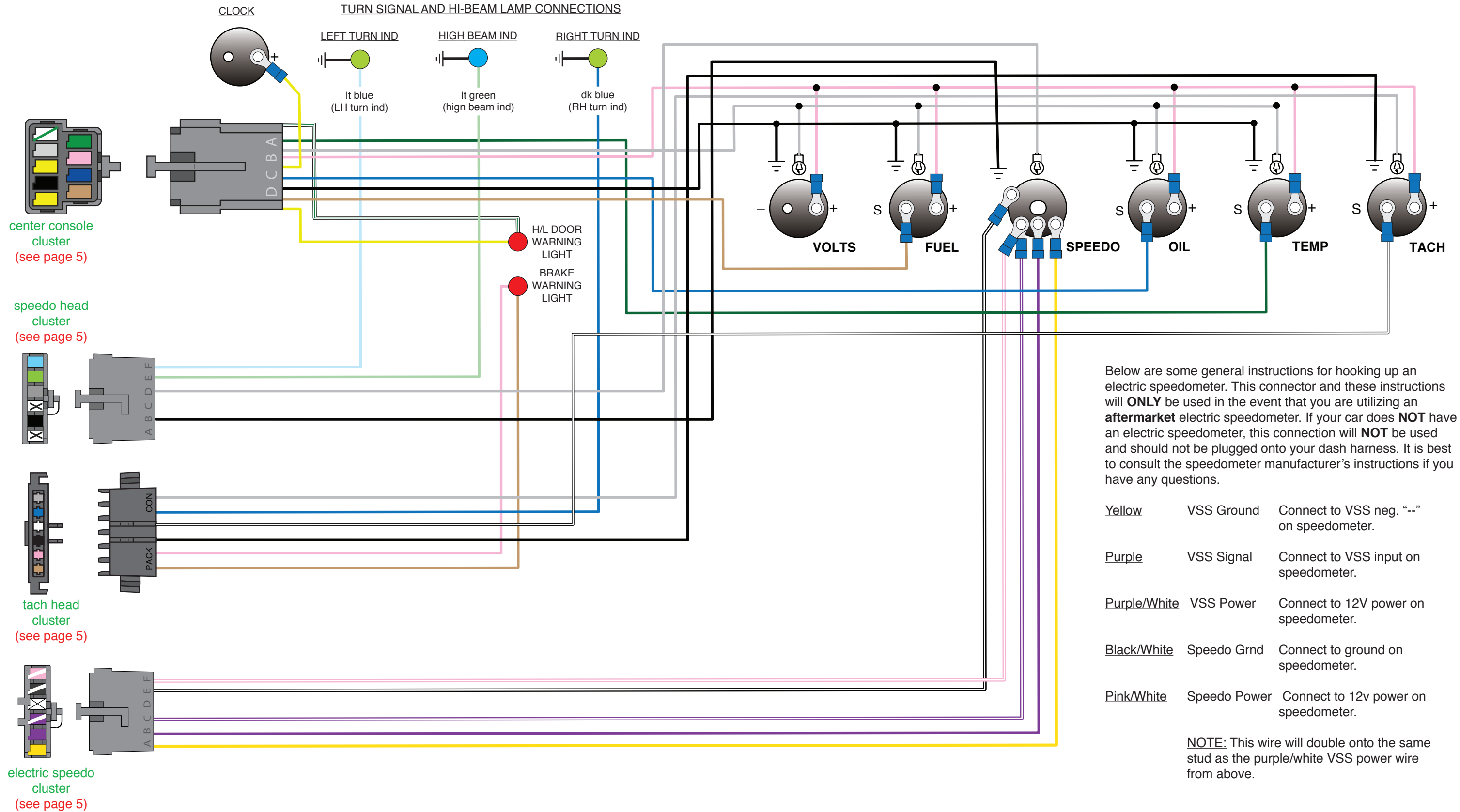

Rear Body harness installation instructions:

Shown below, are the supplied misc. terminals, plastic connector bodies, ground assembly, pigtail extensions and boot and wire extensions that will be used to complete your 510722 Rear Body harness connections. They are itemized and referred to on this page, just as they are on the following pages of this Rear Body instruction set.

A  (male bullet terminal, 4 pcs.)

B  (56 series double female terminal, 8 pcs.)

C  (56 series single female conn, 3 pcs.)

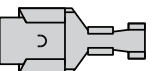
D  (56 series single female terminal, 14 pcs.)

E  (56 series single male terminal, 6 pcs.)

F  (56 series double male terminal, 4 pcs.)

G  (56 series 2-position male connector, 2 pcs.)

H  (56 series 2-position female connector, 1 pc.)

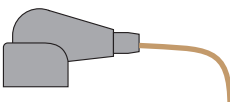
J  (fuel tank molded rubber connector and lead, 1 pc.)

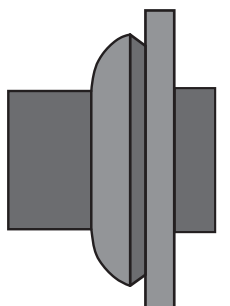
K  (1968-73 rear body pass through grommet, 1 pc.)

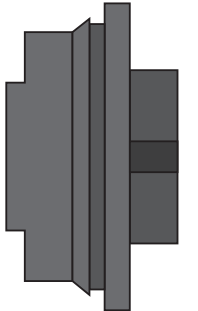
L  (1974-76 rear body pass through grommet, 1 pc.)

M  (68 LH inner tail lamp extension, 1 pc.)

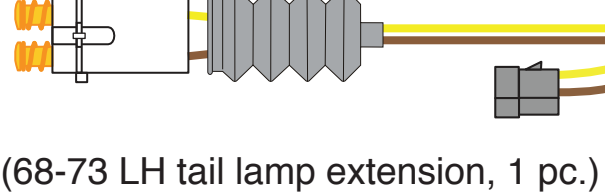
N  (68-73 LH tail lamp extension, 1 pc.)

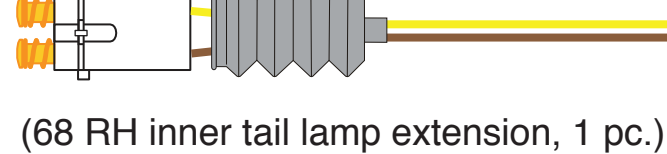
O  (68 RH inner tail lamp extension, 1 pc.)

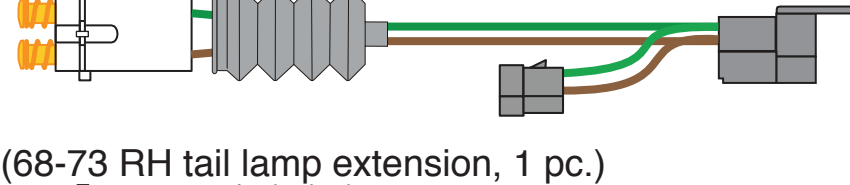
P  (68-73 RH tail lamp extension, 1 pc.)

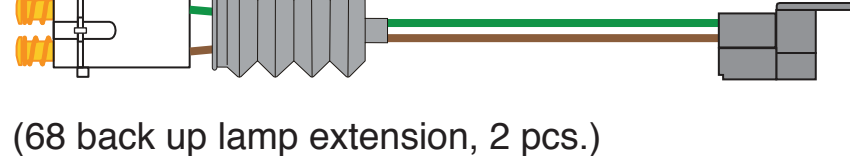
Q  (68 back up lamp extension, 2 pcs.)

R  (69-73 back up lamp extension, 2 pcs.)

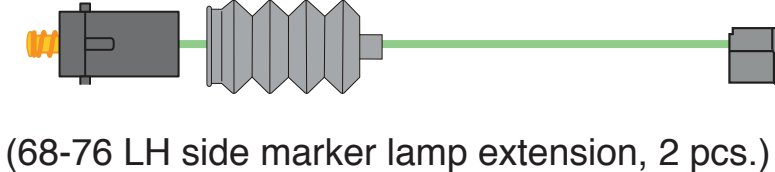
S  (68-76 LH side marker lamp extension, 2 pcs.)

T  (68-76 LH side marker lamp extension, 2 pcs.)

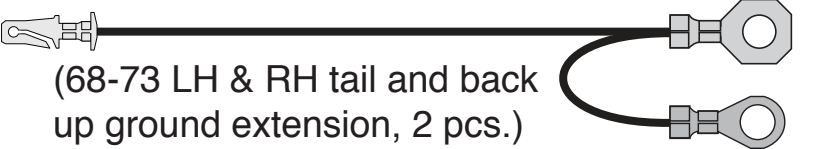
U  (68-73 LH & RH tail and back up ground extension, 2 pcs.)

V  (68-74 gas gauge ground wire, 1 pc.)

W  (68-73 license tag lamp extension, 1 pc.)

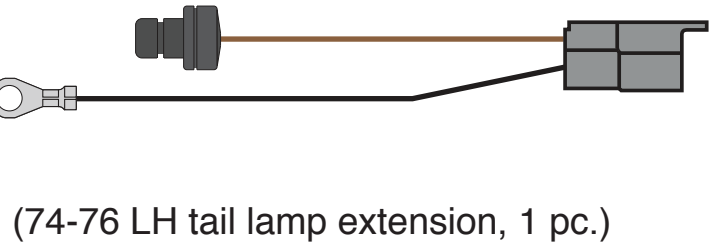
X  (74-76 LH tail lamp extension, 1 pc.)

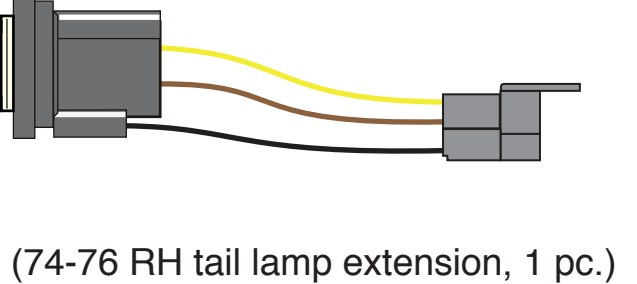
Y  (74-76 RH tail lamp extension, 1 pc.)

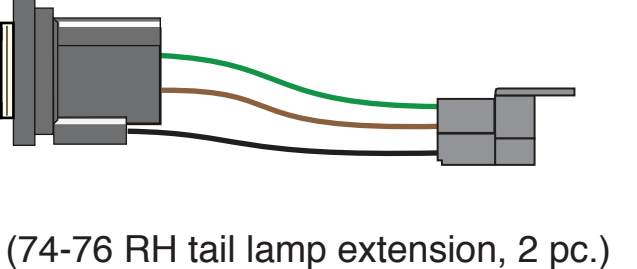
Z  (74-76 RH tail lamp extension, 2 pc.)



**American
Autowire**

1968-76 Corvette
Classic Update Series

Rear Body harness installation instructions cont'd:

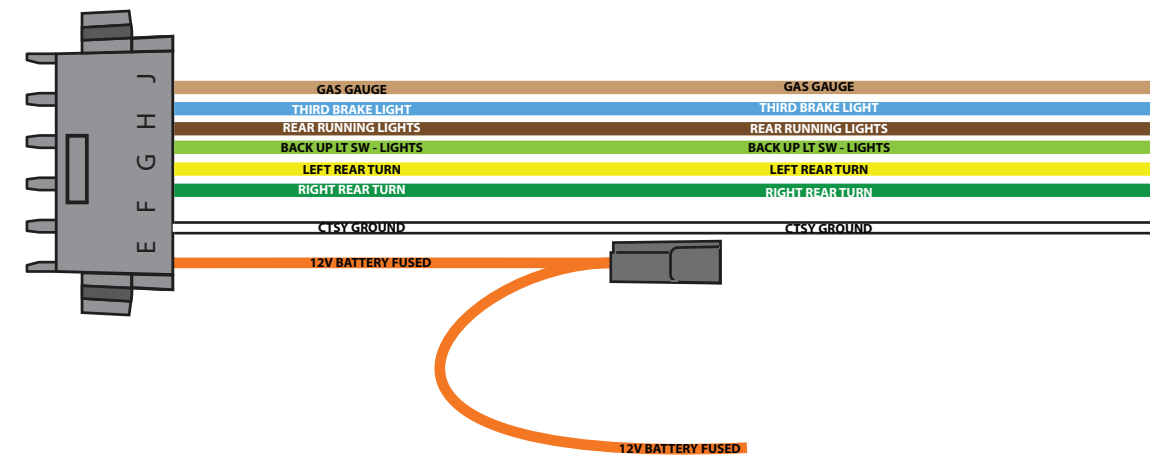
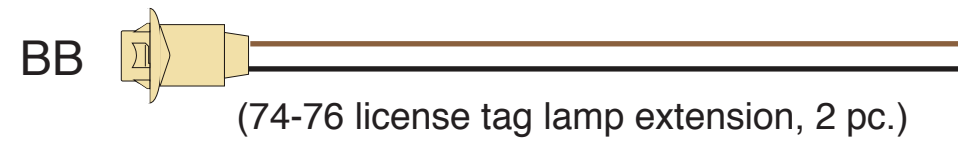
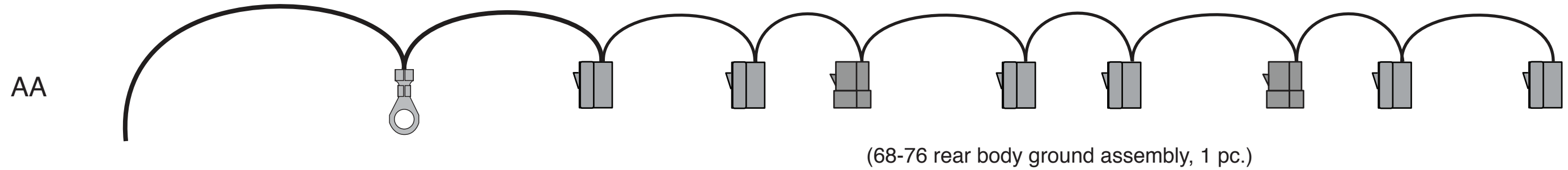

1968 Rear Body harness installation instructions:

1968-76 Corvette

Classic Update Series

510717 92972159 Rev 5.0 1/26/2021



NOTE: Plug main RB connector to dash harness in LH kick panel area as seen on page 5 of these instructions

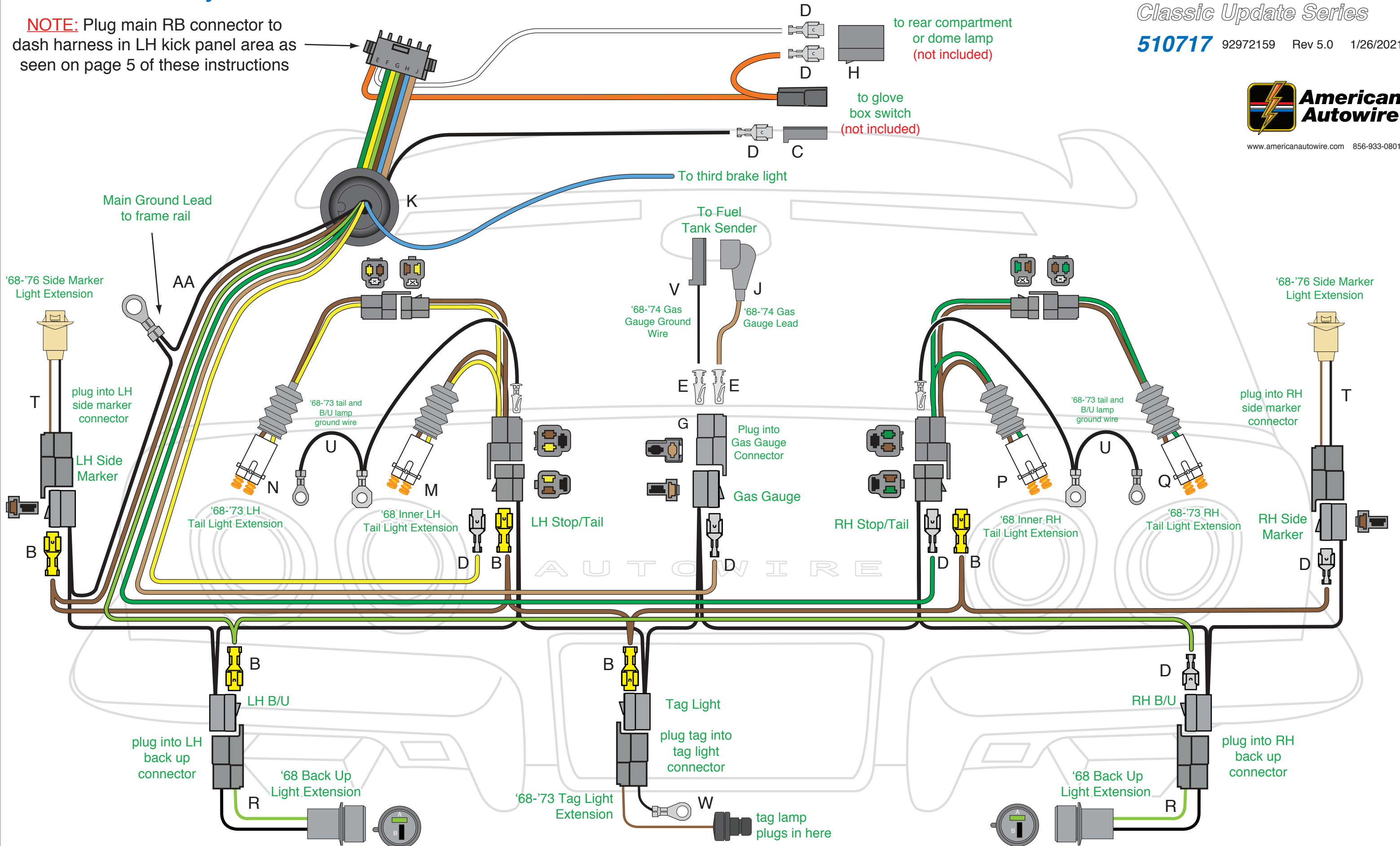

1969-73 Rear Body harness installation instructions:

1968-76 Corvette
Classic Update Series
510717 92972159 Rev 5.0 1/26/2021

NOTE: Plug main RB connector to dash harness in LH kick panel area as seen on page 5 of these instructions

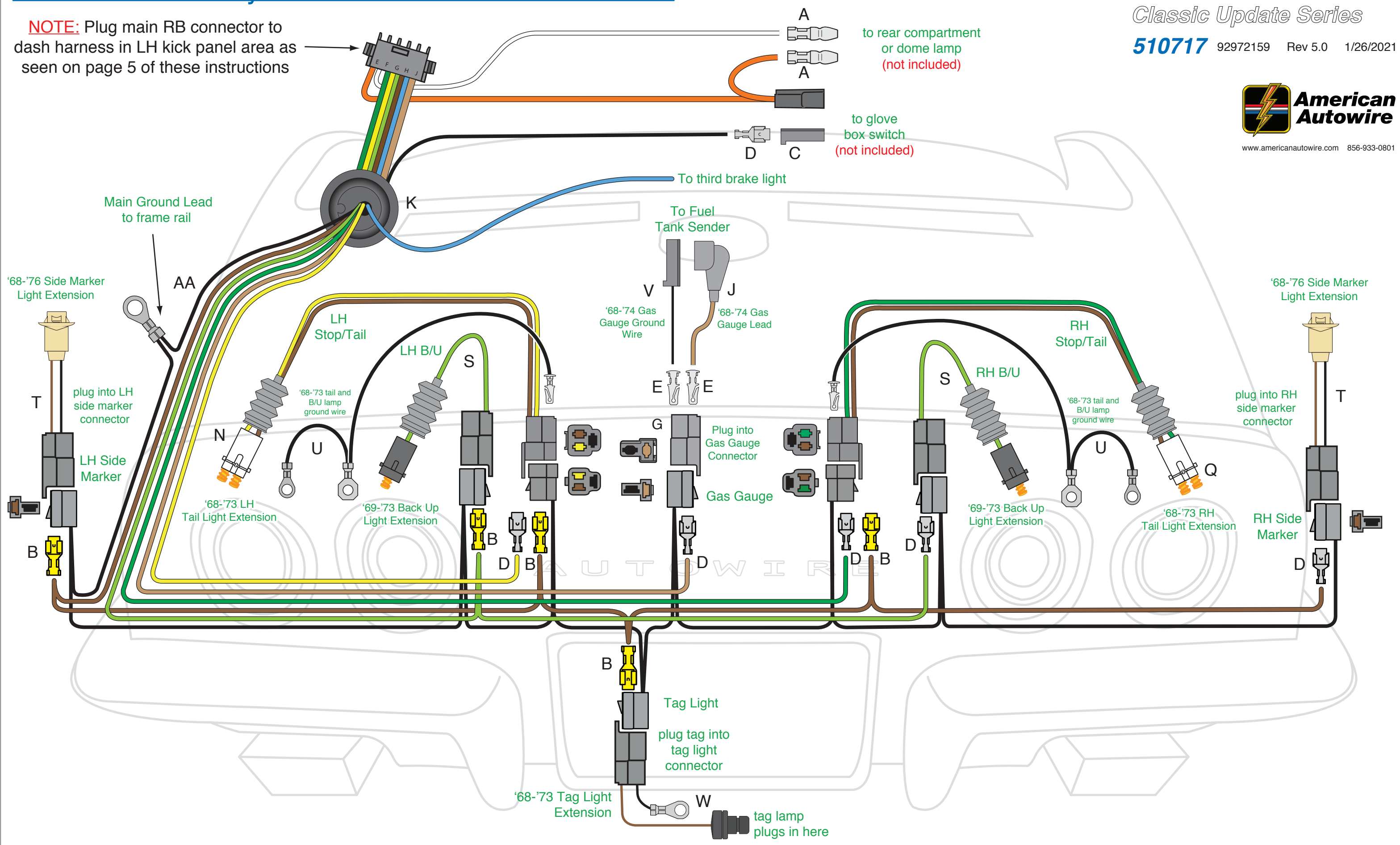

1974-76 Rear Body harness installation instructions:

1968-76 Corvette

Classic Update Series

510717 92972159 Rev 5.0 1/26/2021





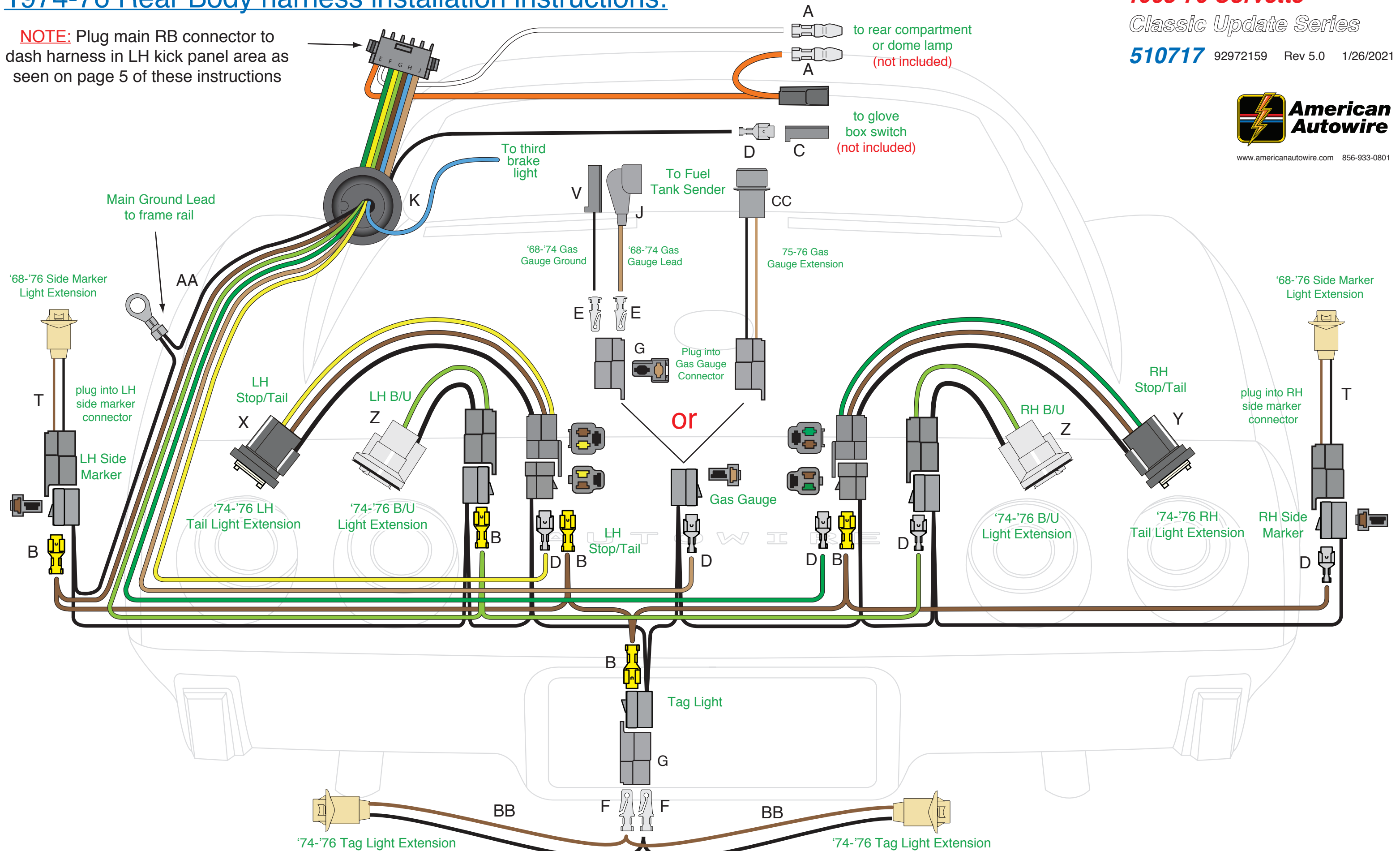





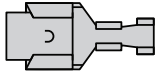
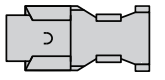

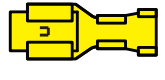
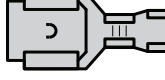
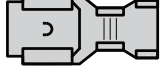

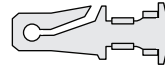
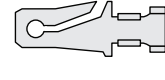



NOTE: Plug main RB connector to dash harness in LH kick panel area as seen on page 5 of these instructions

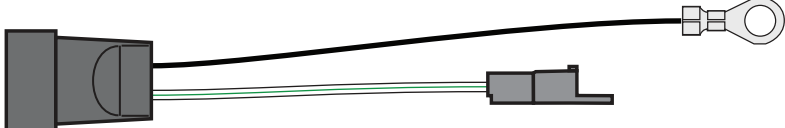

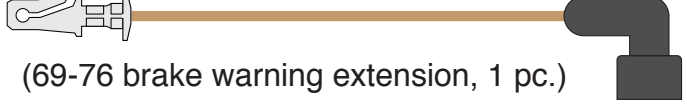
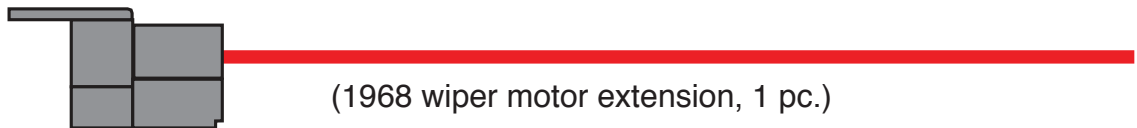

Front Light harness installation instructions:

Shown below, are the supplied misc. terminals, plastic connector bodies and extensions that will be used to complete your 510721 Front Light harness connections. They are itemized and referred to on this page, just as they are on the following pages of this Front Light instruction set.

- A  (56 series single female terminal, 16 pcs.)
- B  (56 series large gauge double female terminal, 12 pcs.)
- C  (56 series single female connector, 4 pcs.)
- D  (56 series small gauge double female terminal, 4 pcs.)
- E  (59 series single female terminal, 4 pcs.)
- F  (59 series double female terminal, 8 pcs.)
- G  (56 series double female connector, 1 pc.)
- H  (56 series single male terminal, 4 pcs.)
- J  (56 series double male terminal, 5 pcs.)
- K  (56 series single female connector with index tab, 1 pc.)
- L  (headlight extension, 2 pcs.)

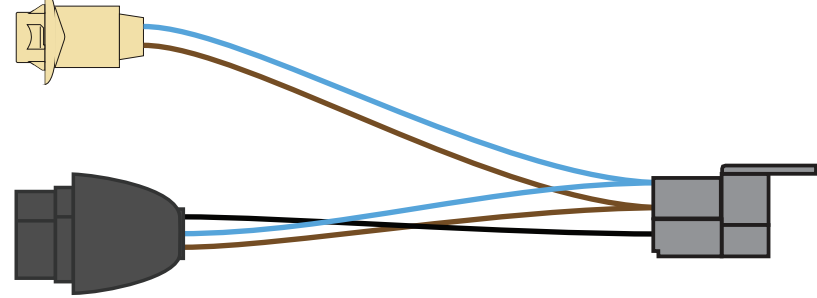
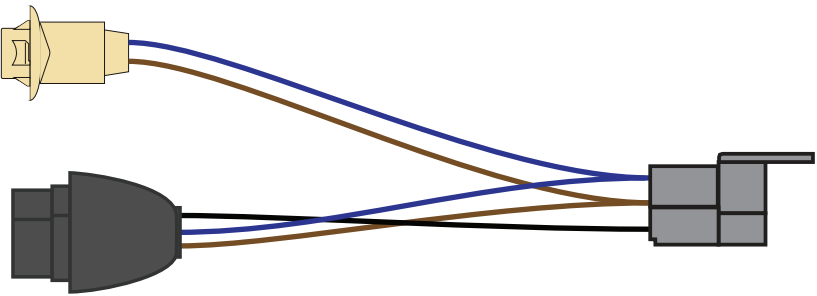
- M  (LH & RH parking and side marker lamp ground pigtails, 2 pcs.)
- N  (69-76 headlight opening warning extensions, 2 pcs.)
- P  (1968 brake warning extension, 1 pc.)
- Q  (69-76 brake warning extension, 1 pc.)
- T  (1968 wiper motor extension, 1 pc.)
- U  (1968 limit switch wire, 1 pc.)
- V  (1968 wiper motor wire, 1 pc.)
- W  (1968 wiper motor/limit switch wire, 1 pc.)
- X  (69-72 limit switch wire, 1 pc.)
- Y  (69-76 headlight opening warning wire, 1 pc.)

- R  (LH parking/side marker lamp extension, 1 pc.)
- S  (RH parking/side marker lamp extension, 1 pc.)
- Z  (68-76 horn ground wire, 1 pc.)



1968-76 Corvette
Classic Update Series
510717 92972159 Rev 5.0 1/26/2021

1968 Front Light harness installation instructions:

1968-76 Corvette

Classic Update Series

510717 92972159 Rev 5.0 1/26/2021



www.americanautowire.com 856-933-0801

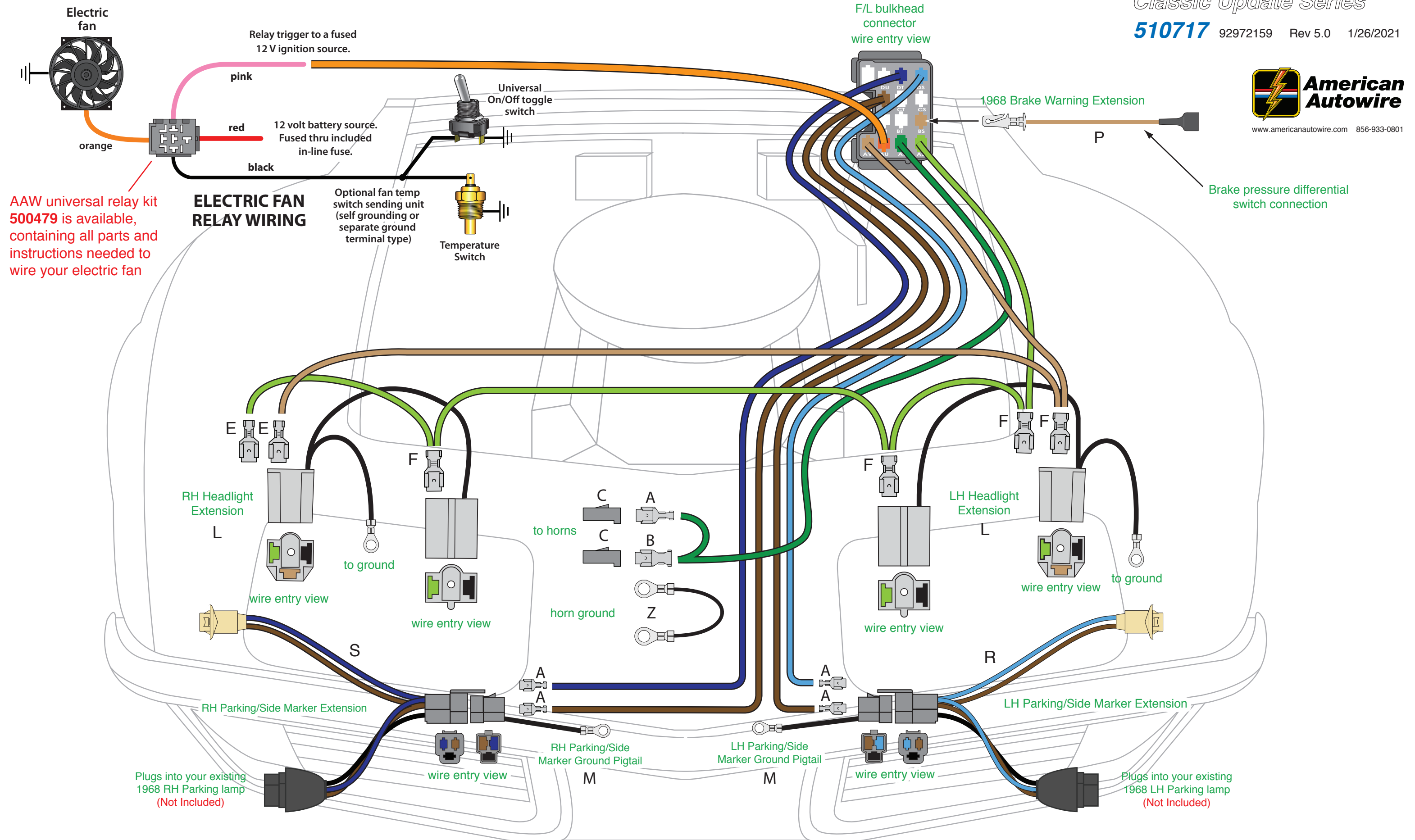

AAW universal relay kit 500479 is available, containing all parts and instructions needed to wire your electric fan

ELECTRIC FAN RELAY WIRING

1969-76 Front Light harness installation instructions:

1968-76 Corvette

Classic Update Series

510717 92972159 Rev 5.0 1/26/2021

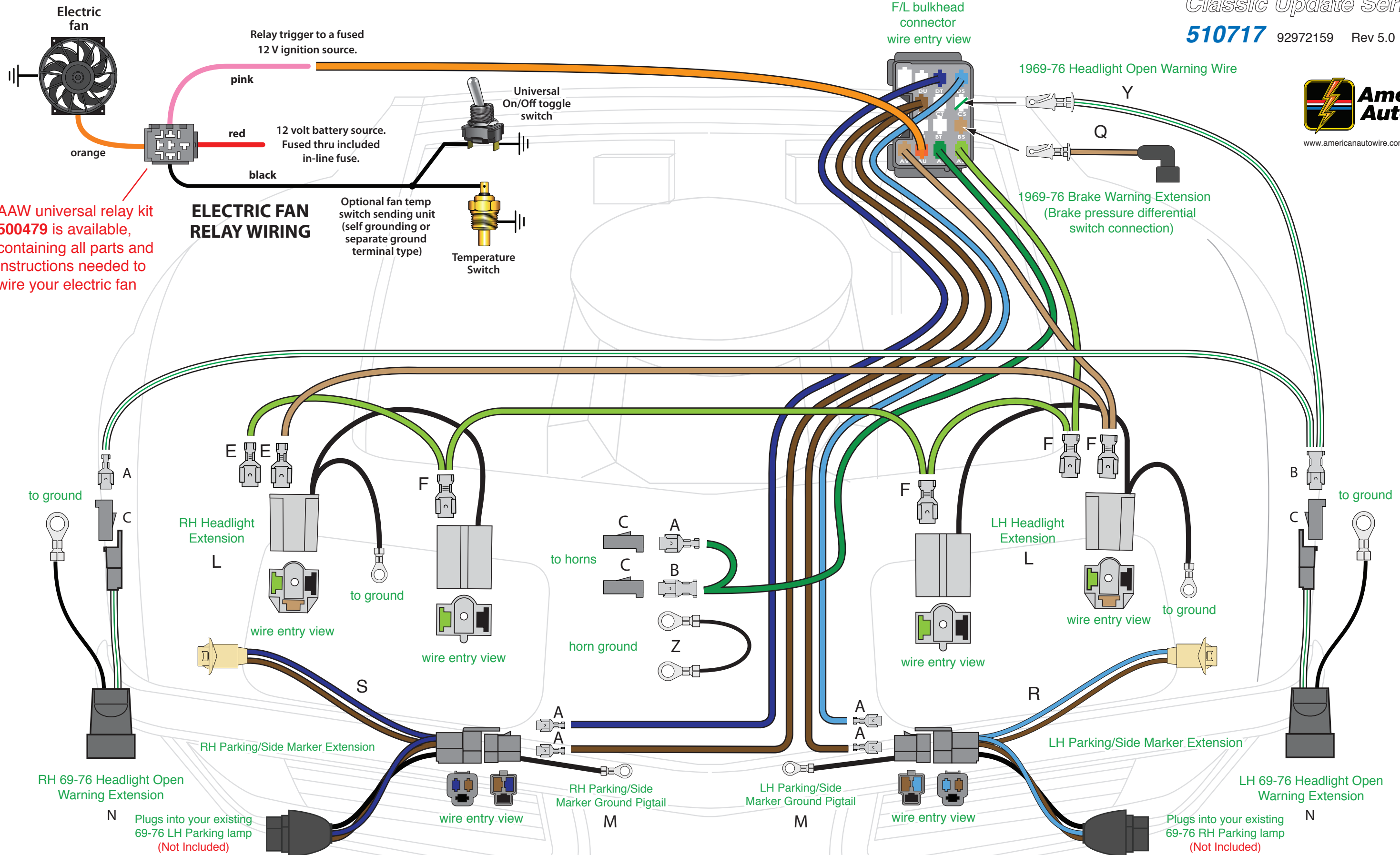

AAW universal relay kit 500479 is available, containing all parts and instructions needed to wire your electric fan

ELECTRIC FAN RELAY WIRING

Wiper motor limit switch installation instructions:

Shown below, are the supplied misc. terminals, plastic connector bodies and wires that will be used to complete your wiper motor limit switch connections. They are itemized and referred to on this page, just as they are on page 20 of this instruction set.

1968 application:

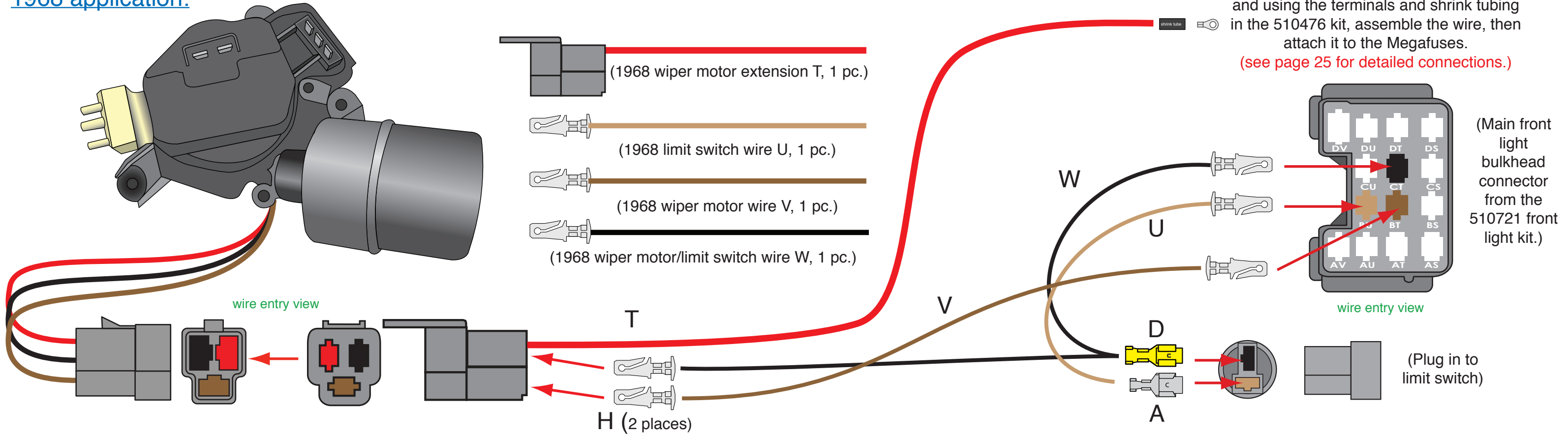



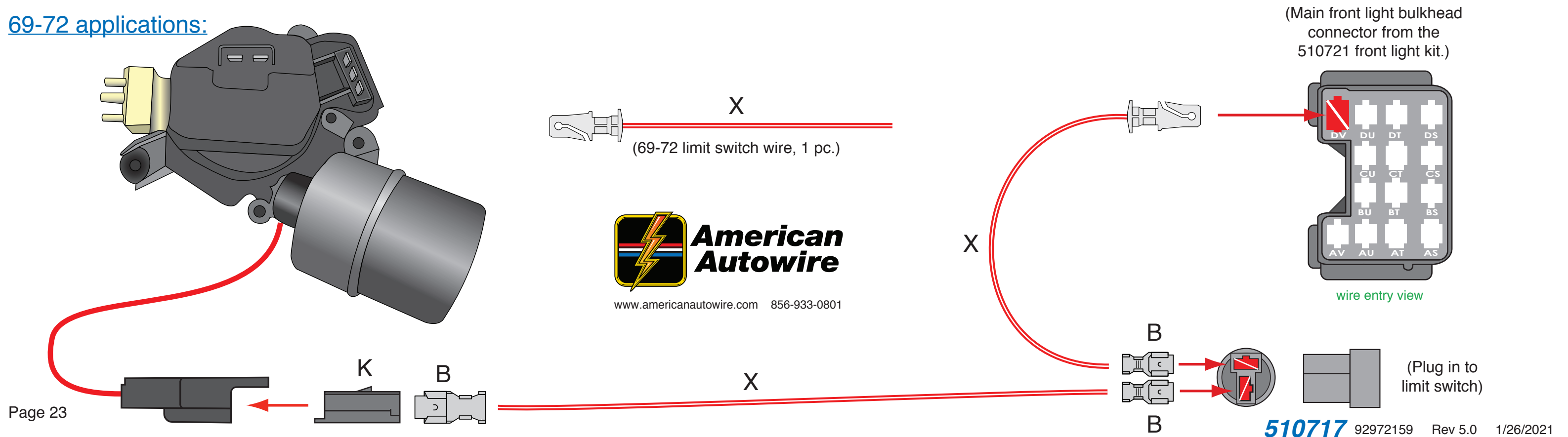









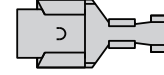

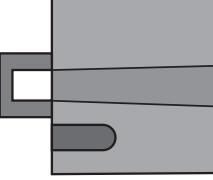
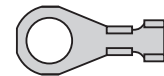

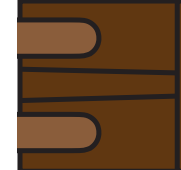
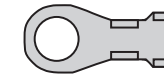

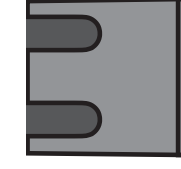

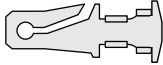
69-72 applications:

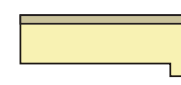

Engine harness installation instructions:

Shown below, are the supplied misc. terminals, sleeves, plastic connector bodies and wires, that will be used to complete your 510720 Engine harness connections. They are itemized and referred to on this page, just as they are on the following pages of this instruction set.

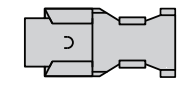
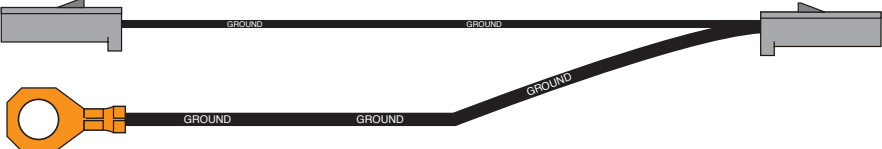
- | | | | | | |
|---|---|---|---|----|--|
| A | 
(56 series 3-postion female connector, 1 pc.) | L | 
(male bullet terminal, 4 pcs.) | W | 
(blower motor feed wire, 1 pc.) |
| B | 
(56 series single female connector, 2 pcs.) | M | 
(56 series single female terminal, 16 pcs.) | X | 
(12V feed wire for T400 kickdown, 1 pc.) |
| C | 
(56 series 2-postion female connector, 1 pc.) | N | 
(small ring terminal for smaller gauge wire, 2 pcs.) | Y | 
(73-75 cold air hood door extension, 1 pc.) |
| D | 
(56 series 2-postion female connector, 1 pc.) | P | 
(small ring terminal for larger gauge wire, 2 pcs.) | Z | 
(T400 kickdown wire, 1 pc.) |
| E | 
(56 series 2-postion female connector, 2 pcs.) | Q | 
(large rubber sleeve, 1 pc.) | AA | 
(56 series single male terminal, 2 pcs.) |
| F | 
(56 series single female connector, 1 pc.) | R | 
(small rubber sleeve, 1 pc.) | | |
| G | 
(56 series single female connector, 1 pc.) | S | 
(molded rubber connector for blower motor, 2 pcs.) | | |
| H | 
(female pin connector, 1 pc.) | T | 
(female pin terminal, 2 pcs.) | | |
| J | 
(56 series single female connector, 1 pc.) | U | 
(GM "SI" alternator exciter wiring, 1 pc.) | | |
| K | 
(56 series double female terminal, 3 pcs.) | V | 
(wiper and blower motor ground assembly, 1 pc.) | | |

Engine harness installation instructions:

REF: 1968 only wiper motor power feed. (See page 23)

(Use the Mega Fuse, ring terminals, boot and shrink tubing from the 510476 kit.)

6 GA. RED (FROM 510476 KIT)

6 GA. RED (FROM 510476 KIT)

SEE DETAIL B

NOTE: for 73-75 models with a T400 and cold air door, double the pink wire from the cold air door harness Y with the tan power feed X in terminal K, then plug into connector E. For manual trans applications, route the pink wire on the cold air door harness Y up to the main bulkhead area, cut to length, apply terminal AA and plug in as shown above.

73-75 cold air hood door harness will plug in here. (not included)

AAW offers an "SI" series alternator to "CS" series alternator conversion kit 37796 (see page 2)

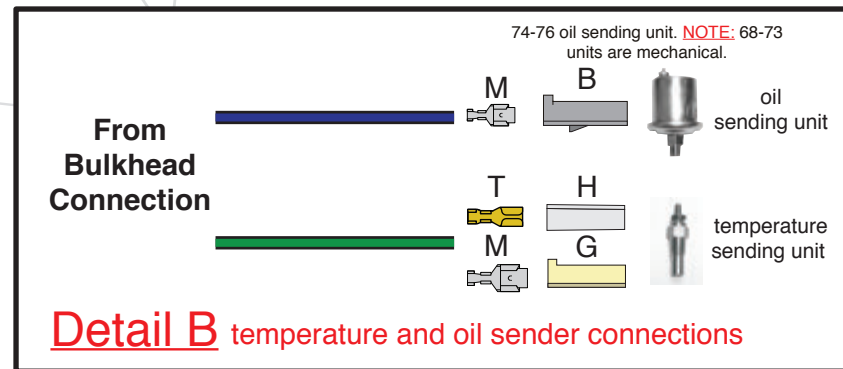
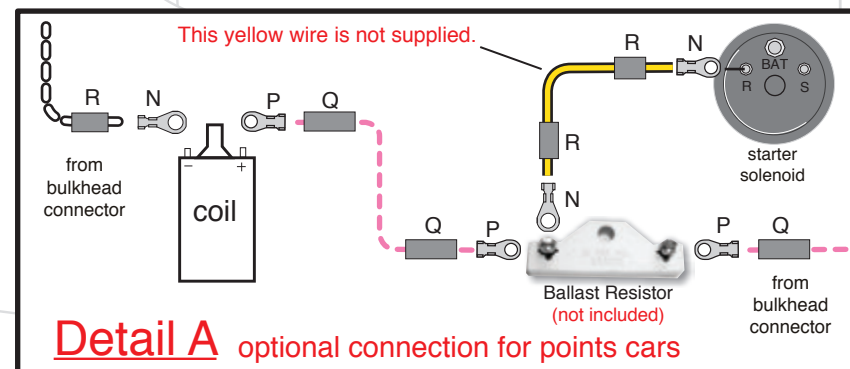

1968-76 Corvette
 Classic Update Series
510717 92972159 Rev 5.0 1/26/2021

Wiper motor and washer pump installation instructions:

Shown below, are the supplied misc. terminals, plastic connector bodies and wires, that will be used to complete your wiper and washer connections. They are itemized and referred to on this page, just as they are on page 24 of this instruction set.

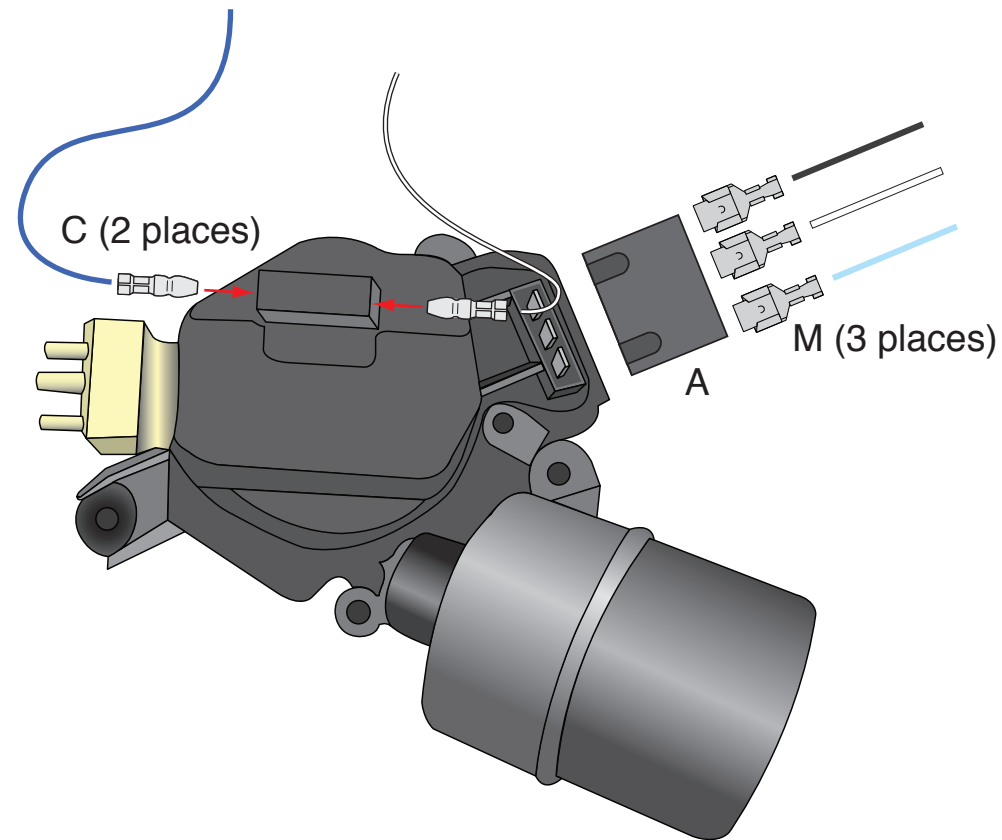

1968 & 1970-74 Wiper and Washer

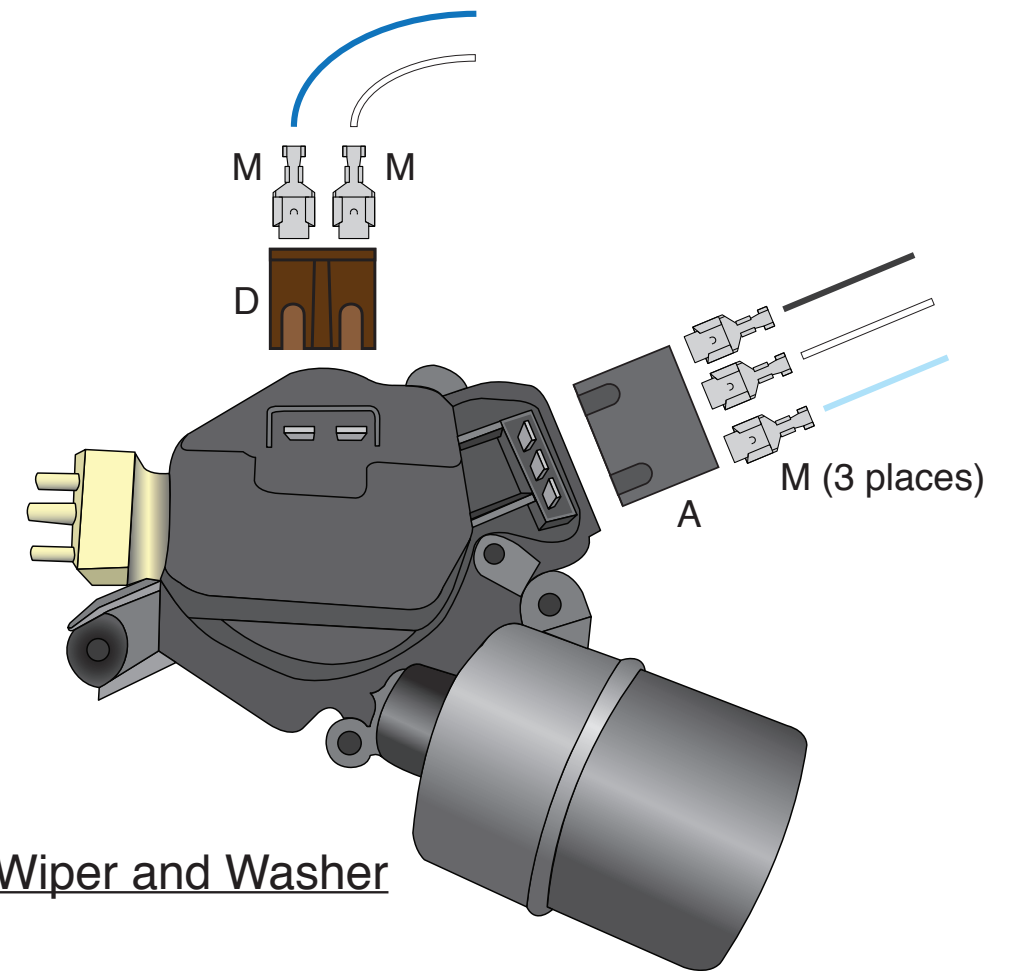
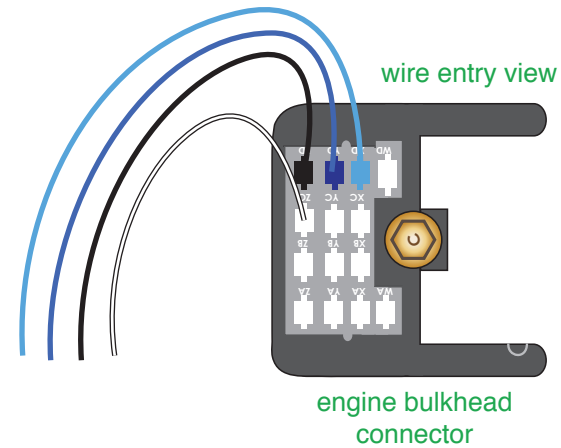

1969 Wiper and Washer

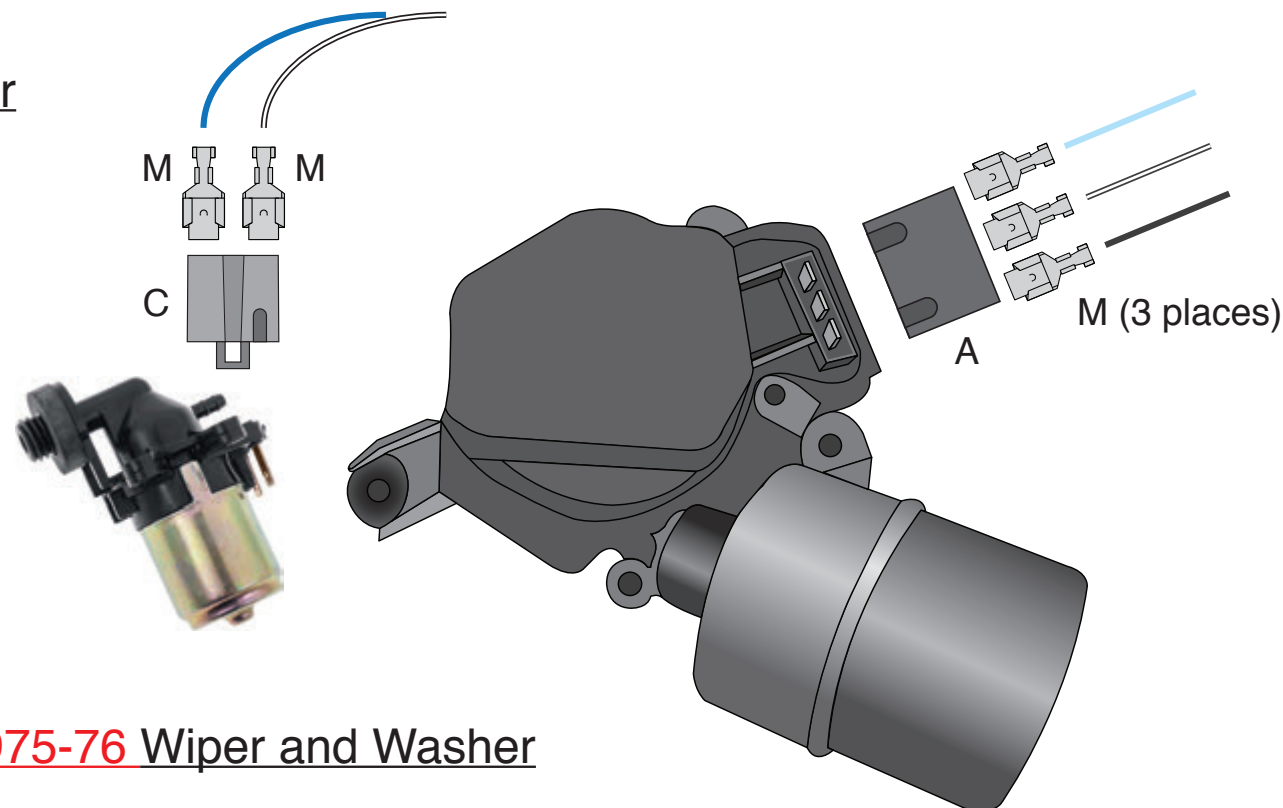

1975-76 Wiper and Washer



www.americanautowire.com 856-933-0801

1968-76 Corvette
Classic Update Series

510717 92972159 Rev 5.0 1/26/2021

STEP 3: RECONNECT YOUR BATTERY:

When you have completed the installation and are ready to reconnect the battery, make sure that the following electrical system grounds are in place:

- A. Battery is grounded to the ENGINE BLOCK.
- B. Battery is grounded to the frame.
- C. Engine block is grounded to the frame.
- D. Body is grounded to the frame.

STEP 4: CHECK ALL ELECTRICAL FUNCTIONS:

Any non-functioning items should be checked for proper installation. Any problems with your wiring and electrical circuit functions, should be addressed to American Autowire Systems, Inc. as soon as possible, to avoid any warranty problems.

If you have any questions concerning this or any of our products, please feel free to call us at 1-856-933-0801.



www.americanautowire.com 856-933-0801

1968-76 Corvette

Classic Update Series

510717 92972159 Rev 5.0 1/26/2021

THIS PAGE HAS INTENTIONALLY
BEEN LEFT BLANK