



Instr. No. 2650-238J

INSTALLATION INSTRUCTIONS PRO-CONTROL

MODEL 5301, 5302, 5304, 5305, 5306, 5307, 5308, 5309



IMPORTANT
Inductive Triggered instrument must use its own pick-up. (Part Number 5210)

TERMINAL STRIP FOR OPTIONAL WIRING

For Reset Models (5304, 5305, 5306)
The reset function locks the Pro-Control in the tripped mode once the set RPM is reached. The reset button must be pushed to reset the Pro-Control.

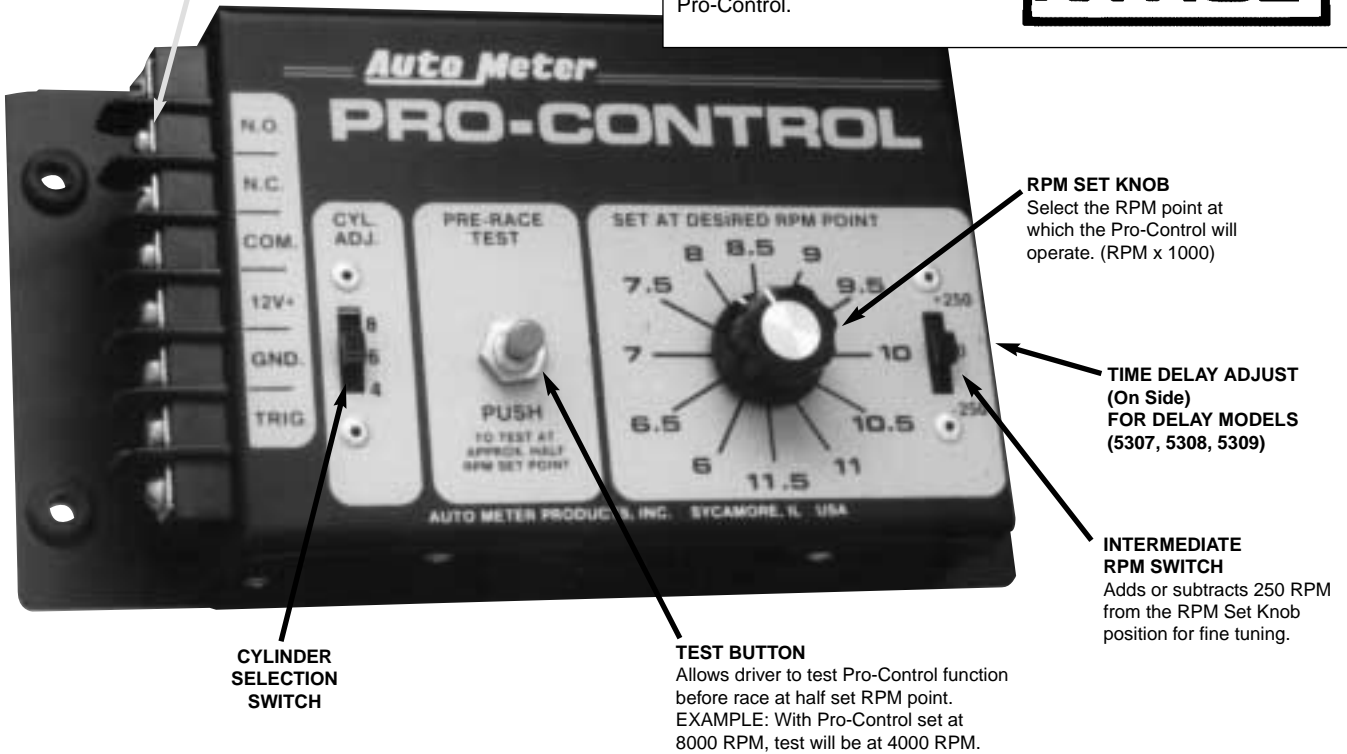

ABOUT YOUR PRO-CONTROL

Pro-Control can be used for any single rpm-related function, such as a rev-limiter, shift light activator, or nitrous oxide trigger. When used as a rev-limiter, Pro-Control guards against over-revving by allowing the engine to run with 100% power until it reaches the pre-set rpm level. Models WITHOUT RESET BUTTON will automatically interrupt ignition power for a fraction of a second and then restore it for continued racing power. Models WITH RESET BUTTON are for super-charged (blown) engines. Reset unit shuts off ignition completely to prevent engine damage. Reset button must be pushed to restart engine. Models with By-Pass Delay can be used in conjunction with a 12 volt signal from Line Lok and/or Trans-Brake to deactivate the Pro-control. This will prevent shifting during burnouts. The adjustable delay feature can be set between .1 to 1 second to control deactivation time. This will prevent short shifting after Line Lok and/or Trans-Brake is released.

Without Reset Button

- 5301 For Standard/Electronic Ignitions
- 5302 For Vertex Magneto OAC Ignitions
- 5304 For Standard/Electronic Ignitions
- 5305 For Vertex Magneto OAC Ignitions
- 5306 For Vertex Mag OXC or Super Mag Ignitions

With By-Pass Delay

- 5307 For Standard/Electronic Ignitions
- 5308 For Vertex Magneto OAC Ignitions
- 5309 For Vertex Mag OXC or Super Mag Ignitions

PRO-CONTROL WIRING

Rev-Limiting

Model 5301

Standard Ignition
(Single or Dual Points)

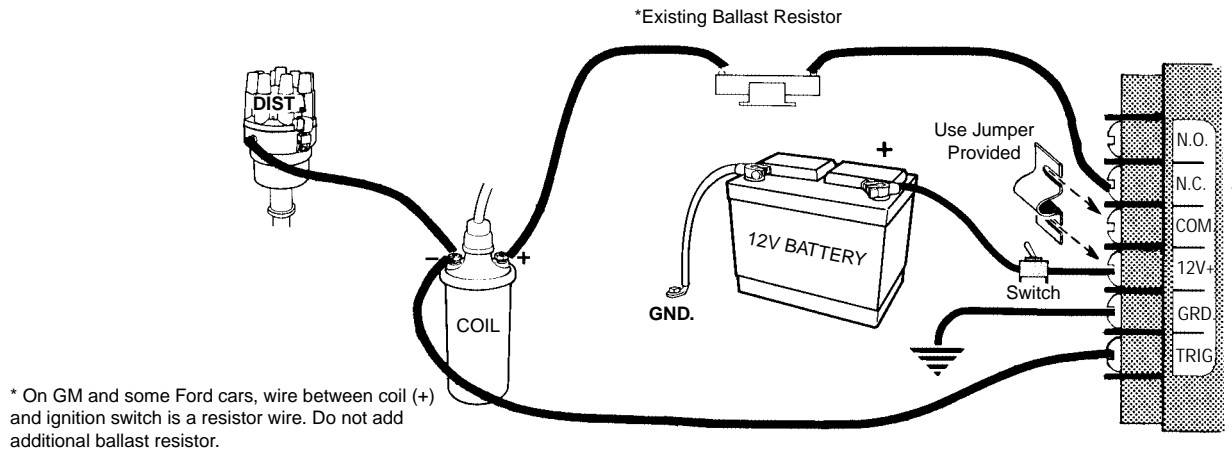

Rev-Limiting

Model 5301 Most Electronic Ignitions

Connect trigger to coil (-) on most electronic ignitions or tach terminal if available.

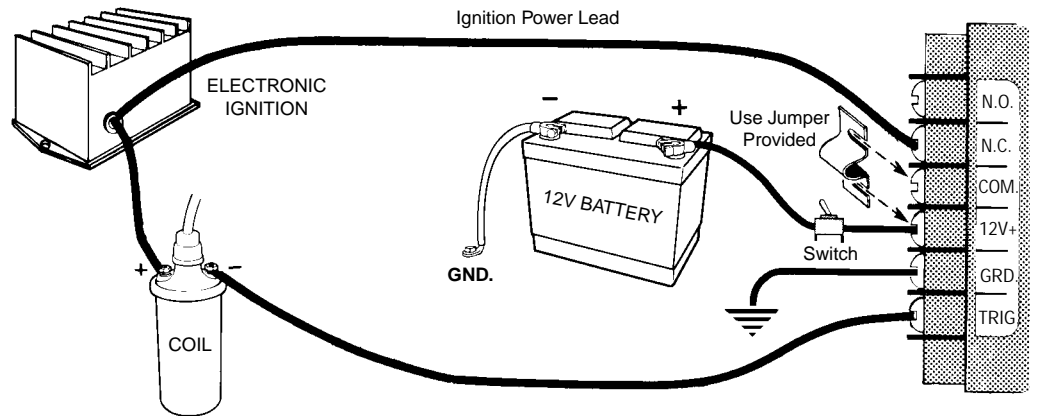

Rev-Limiting

Model 5301 MSD Ignitions

WARNING

Warranty will be void if connected to coil on MSD ignitions. Attach to tach terminal.

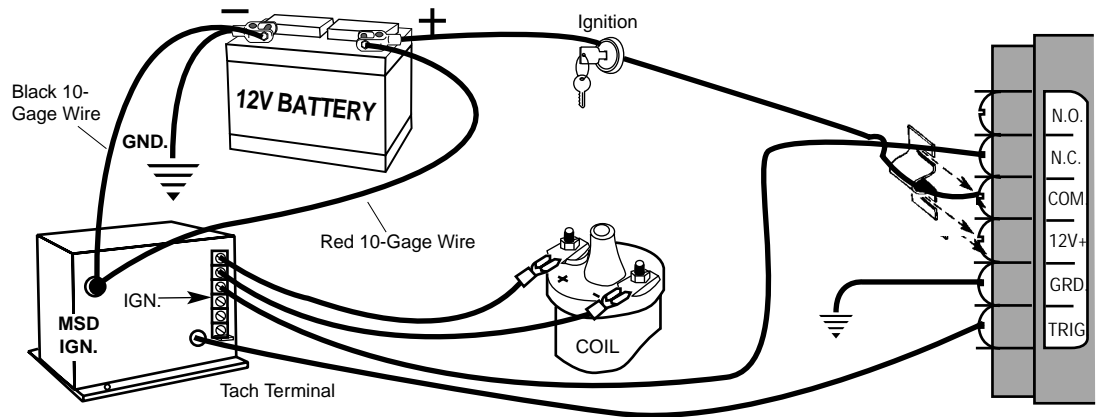

*NOTE: Not for use with MSD 6 Series boxes.

Rev-Limiting

Model 5302, 5305 Vertex Magneto

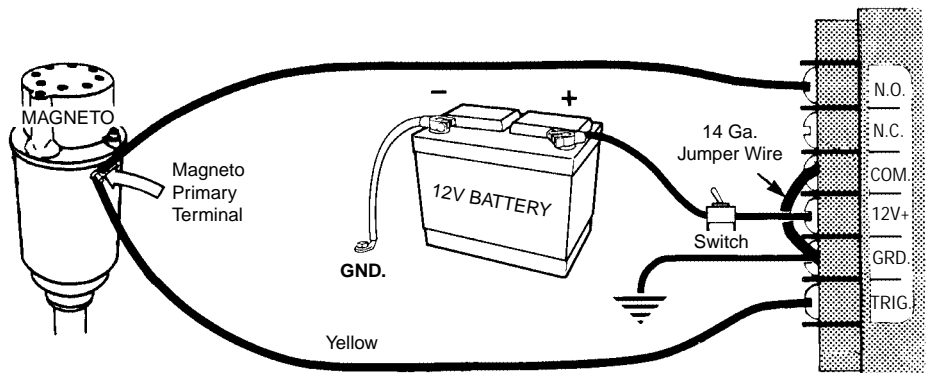

Rev-Limiting

Model 5306 Super Magneto

Battery power must be switched on to Pro-Control before starting engine or a no start will result.

IMPORTANT

Inductive Triggered instrument must use its own pick-up. (Part Number 5210)

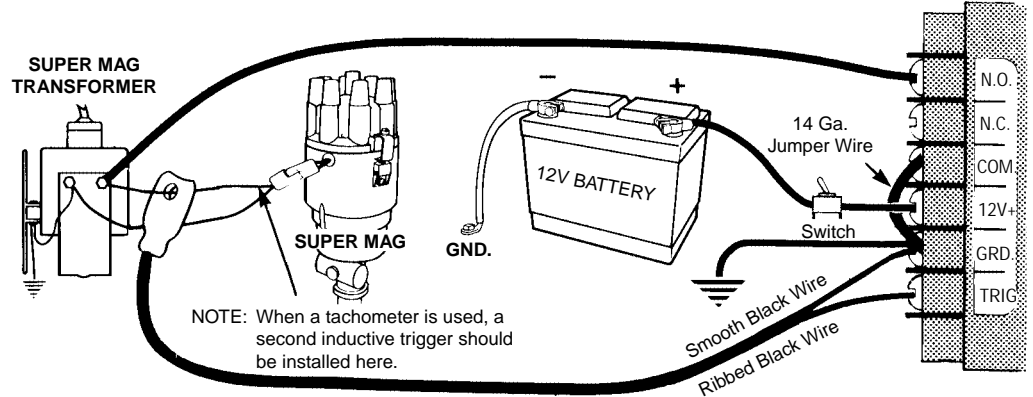

Rev-Limiting

Model 5306 Super Magneto Vertex OXC

IMPORTANT

Inductive Triggered instrument must use its own pick-up. (Part Number 5210)

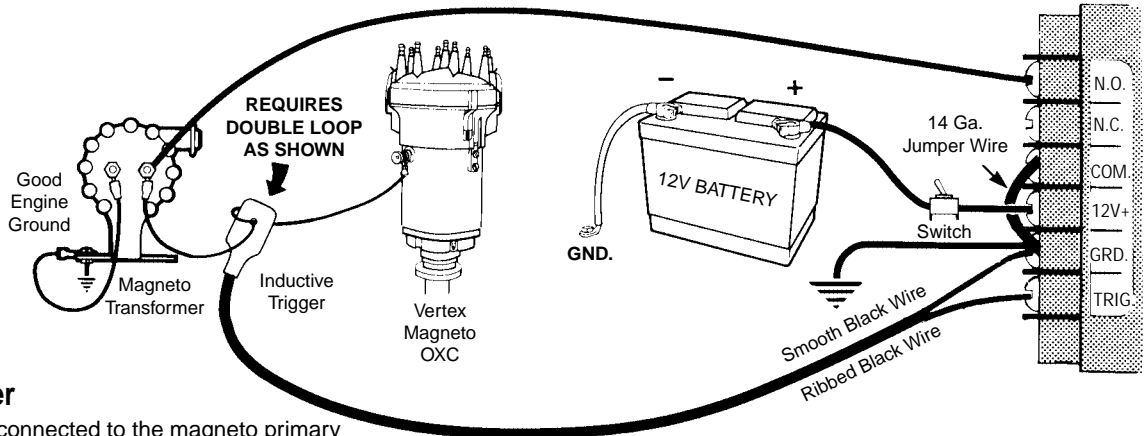

Installing Inductive Trigger

The Inductive Trigger should be connected to the magneto primary wire as shown here. Be sure to secure the Inductive Trigger with the nylon wire tie to prevent strain on magneto primary wires.

For Air Shifter Or Shift Lamp

Model 5301 & 5302 or 5307 & 5308

This hookup supplies 12 volts to lamp when set RPM is reached.

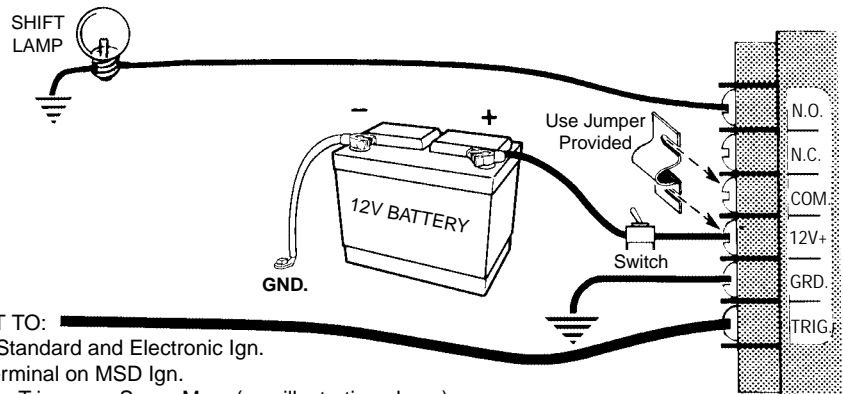

CONNECT TO:

- coil on Standard and Electronic Ign.
 - Tach Terminal on MSD Ign.
 - Inductive Trigger on Super Mag. (see illustration above)
 - Mag. Pri. Terminal on Vertex Magneto. (see illustration above)
- See "Rev-Limiting" wiring diagram for your trigger wiring application.

Override & Delay Functions For Air Shifter *Model 5307, 5308 & 5309*

Your Pro-Control can be deactivated to prevent shifting during burnout and short shifting at launch. This is accomplished by supplying 12V power to the delay lead-blue terminal(s).

To prevent automatic air shifting during burnout, connect delay lead to line lock switch.

For timed deactivation on launch, connect delay lead to the trans brake, or use a clutch switch. When the switch is opened, time delay will begin. This allows RPM to rise above the shift point briefly without activating the automatic shifter and causing a short shift.

The delay timer can be set to reactivate from .1 to 1.0 seconds after the delay switch is turned off. To adjust timer, remove plug at end of Pro-Control. Insert screwdriver and carefully turn adjuster. Do not force. See illustration at right.

Two delay leads are provided to allow simultaneous connections of a line lock, trans. brake and/or clutch switch without causing interaction between the two systems. If a single lead were used, electrical feedback to the unused component would occur. For example, during burnout the line lock power would activate the trans. brake through the delay warning.

IMPORTANT
Inductive Triggered instrument must use its own pick-up. (Part Number 5210)

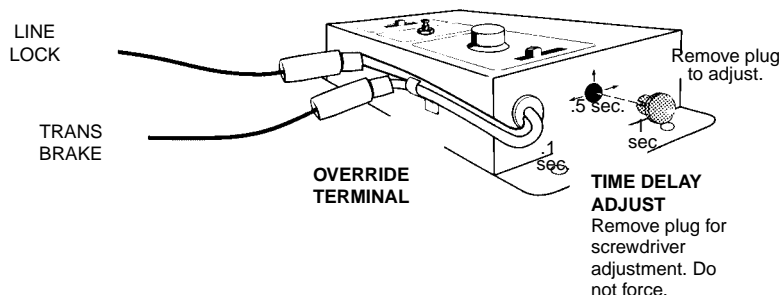

Installation Tips

1. Mount Pro-Control base firmly to reduce excess vibration wear and tear.
2. A 12V power source **MUST** be used to power the Pro-Control. A 12V motorcycle battery or gel cell is a good alternative for cars without batteries. A battery with a 5 amp hour minimum rating is recommended.
3. If you are using high current or prefer extra protection, use a fuse in the relay circuit to prevent accidental damage because of shorts or grounds.
4. Wherever possible solder wire connections and avoid crimp-type connectors. This will minimize loose connections that could cause problems later. Protect connections from tugging or vibrational damage by adding strain reliefs at all connections.
5. Make sure you have a good ground to engine and battery negative terminal.
6. Wire installations should be neat and tied down to prevent tugging and fraying of wires at connections.

Trouble Shooting

1. Did you purchase the correct Pro-Control? (Models 5301, 5304 & 5307-Std./Elec. Ign., Models 5302, 5305 & 5308-Vertex Mag OAC Ign., Models 5306 & 5309-Vertex OXC and Super Mag Ign.)
2. Did you select the correct cylinder range?
3. Are all electrical connections correct and tight?
4. Is the Inductive Trigger installed correctly? (Models 5306 & 5309)
5. If problems persist try Pro-Control on another vehicle with the same ignition.
6. If you cannot resolve the problem call Auto Meter Customer Service: (815) 895-8141

SERVICE

For service send your product in a well packed shipping carton to the address below. Please include a note explaining what the problem is along with your phone number. Please specify when you need the product back. Normal repairs take approximately ten (10) working days. If you are sending product back for Warranty adjustment, you must include a copy (or original) of your sales receipt from the place of purchase.

12 MONTH LIMITED WARRANTY

The manufacturer warrants to the consumer that this product will be free from defects in materials and workmanship for a period of twelve (12) months from the date of the original purchase. Products that fail within this 12 month warranty period will be repaired or replaced at the manufacturer's option to the consumer, when determined by the manufacturer that the product failed because of defects in material or workmanship. This warranty is limited to the repair or replacement of parts in the instrument and the necessary labor done by the manufacturer to affect the repair or replacement of the instrument. In no event shall this warranty exceed the original purchase price of the instrument, nor shall the manufacturer be responsible for special, incidental or consequential damages or costs incurred due to failure of this product. Warranty claims to the manufacturer must be transportation prepaid and accompanied with dated proof of purchase. This warranty applies only to the original purchaser of product and is non-transferable. All implied warranties shall be limited in duration to the said 12 month warranty period. Breaking the instrument seal, improper use or installation, accident, water damage, abuse, unauthorized repairs or alterations voids this warranty. The manufacturer disclaims any liability for consequential damages due to breach of any written or implied warranty on all products made by the manufacturer.

FOR SERVICE CONTACT: AUTO METER PRODUCTS Inc. 413 W. Elm St., Sycamore, IL 60178 USA (815)895-8141 or
Email us at service@autometer.com