

MSD[®] IGNITION INSTALLATION INSTRUCTIONS

Adjustable Timing Control PN 8680

IMPORTANT: Read the instructions before attempting installation.

Parts Included:

- | | |
|-----------------------------|----------------------------------|
| 1 - Timing Control, PN 8680 | 1 - Control Knob |
| 1 - 3/8" Bushing | 1 - 2-Pin Weathertight Connector |
| 4 - Self Tapping Screws | |

WARNING: During installation, disconnect the battery cables. When disconnecting the battery, always remove the Negative cable first and install it last.

Note: The MSD PN 8680 Timing Control **must be used** with an MSD Ignition Control. It is recommended to install the MSD Ignition first.

MOUNTING

The Timing Computer may be mounted in the engine compartment as long as it is away from direct engine heat sources. Make sure all of the wires reach their connections before mounting the unit. Use the Control as a template and mark the mounting holes. Remove the unit and drill the mounting holes using an 1/8" drill bit. Four self tapping screws are supplied to mount the unit. **Note:** Before mounting the unit, install the supplied grommets and sleeves as shown in Figure 1.

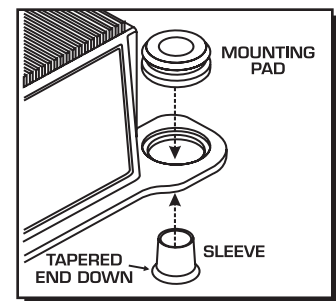

Figure 1 Installing the Vibration Mounts.

PROGRAMMING

The Timing Control is programmed for 8-cylinder operation using the Points (White wire) input. If installing the PN 8680 on a 4 or 6-cylinder or are using a magnetic pickup to trigger the ignition, the Control must be programmed as follows.

Locate the Cylinder Select cover on the side of the unit and remove the single Phillips screw (Figure 2).

Number of Cylinders: The Red loop and the Blue loop are responsible for cylinder programming. The chart in Figure 2 shows which loop(s) to cut.

Trigger Selection: If using a magnetic pickup trigger, the White loop must be cut (Figure 2).

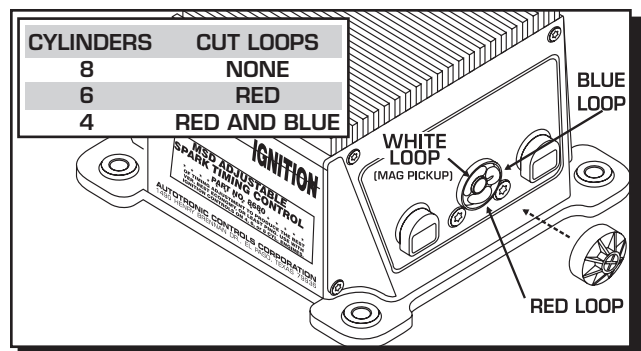

Figure 2 Selecting the Number of Cylinders.

Note: After cutting a loop, position the wire ends away from each other so they cannot make contact.

WIRING

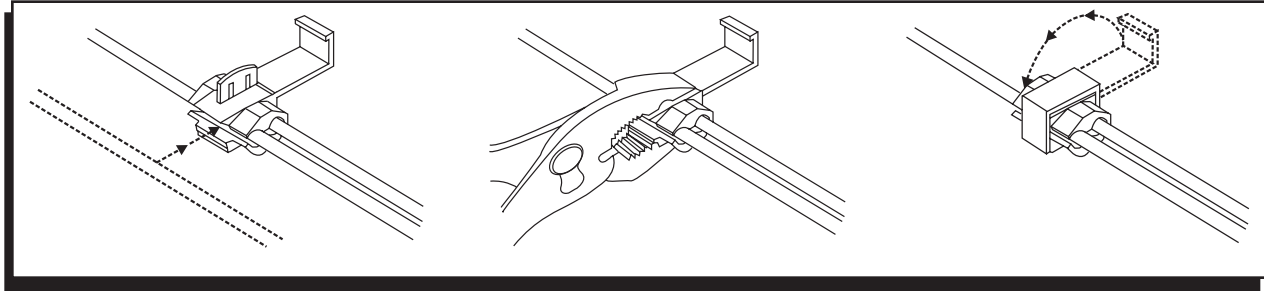

Figure 3 How to use the Supplied Wire Splice Device.

WIRE FUNCTIONS

Yellow	This is the trigger output wire. It connects to the White wire of an MSD 6 Series Ignition or "Points" terminal of a 7 Series Ignition.
Red	This wire is responsible for turning the Timing Control on and off. It connects to switched 12 volt source. It can be spliced into the small red wire of the MSD.
Black	This is the ground wire and must be connected to a good engine or chassis ground.

TRIGGER WIRES

Violet Green	These wires connect to the magnetic pickup of the distributor or crank trigger. The Violet is positive (+) and the Green wire is negative (-). When this connector is used the White wire is not.
White	This is the trigger input wire for breaker points or ignition amplifier. When this wire is used, the magnetic pickup wires (violet and green) are not.

Control Knob

The Black and Gray wires with the 2-Pin Weathertight connector are the Control Knob wires. After the Timing Control is mounted, the Harness should be routed to the unit. The Control Knob should be mounted within easy reach of the driver. Before mounting the Control Knob, make sure the wiring harness reaches the unit.

If the harness must be routed through the firewall, drill a 3/8" hole and use the supplied grommet to route the wires through. Install the supplied 2-Pin Weathertight connector to the wires after all of the routing is finished (Figure 4). **The position of the wires in the connector is not important.**

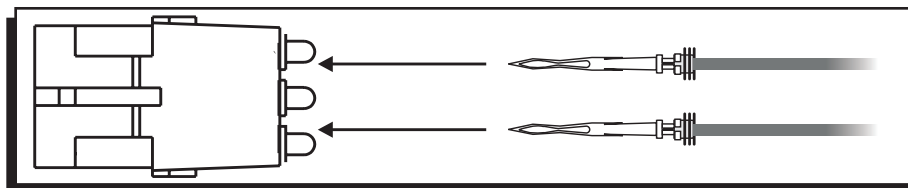

Figure 4 Installing the Weathertight Connector.

Operating the Control

After installation, it is recommended to check the timing. Before starting the vehicle, turn the Control Knob to the full 15° mark. This is the stock timing setting. As the Knob is turned counterclockwise, the timing retards. As detonation occurs, slowly retard the timing until the "pinging" noise is not audible. Adjust the timing as driving conditions change.

Resetting the Timing

It is possible to set the Timing Control up to where you can retard and advance the timing 7.5° each. To do this, position the Control Knob in the center (approximately 7.5°) then reset the timing to factory specifications.

DIAGRAMS

The following wiring diagrams show common installations.

Note: The MSD 6 and 7 Series Ignitions share the same wire colors.

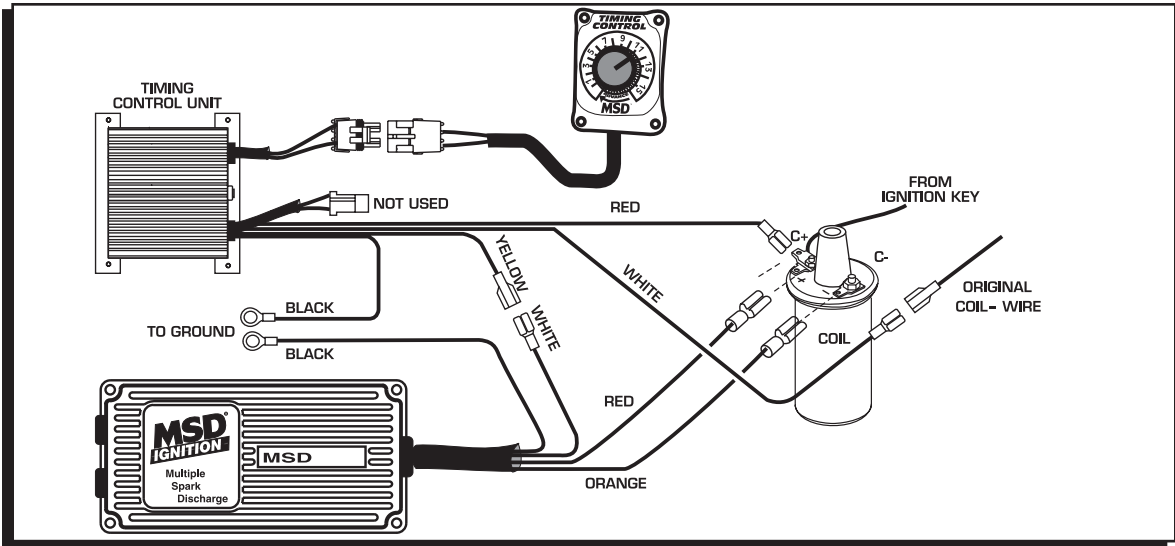

Figure 5 Wiring to a Points or Amplifier Ignition with an MSD 5 or Blaster Ignition using the Points Trigger.

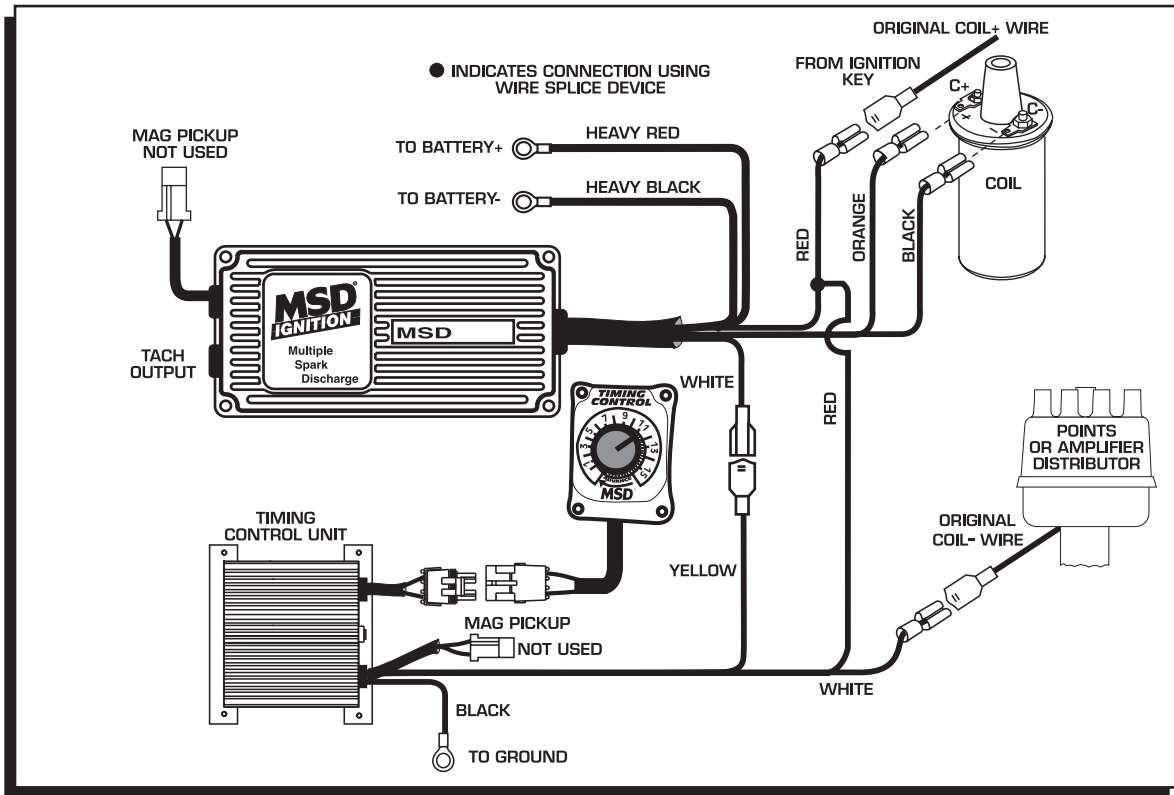

Figure 6 Wiring to Points or Amplifier Ignition with an MSD 6 Series.

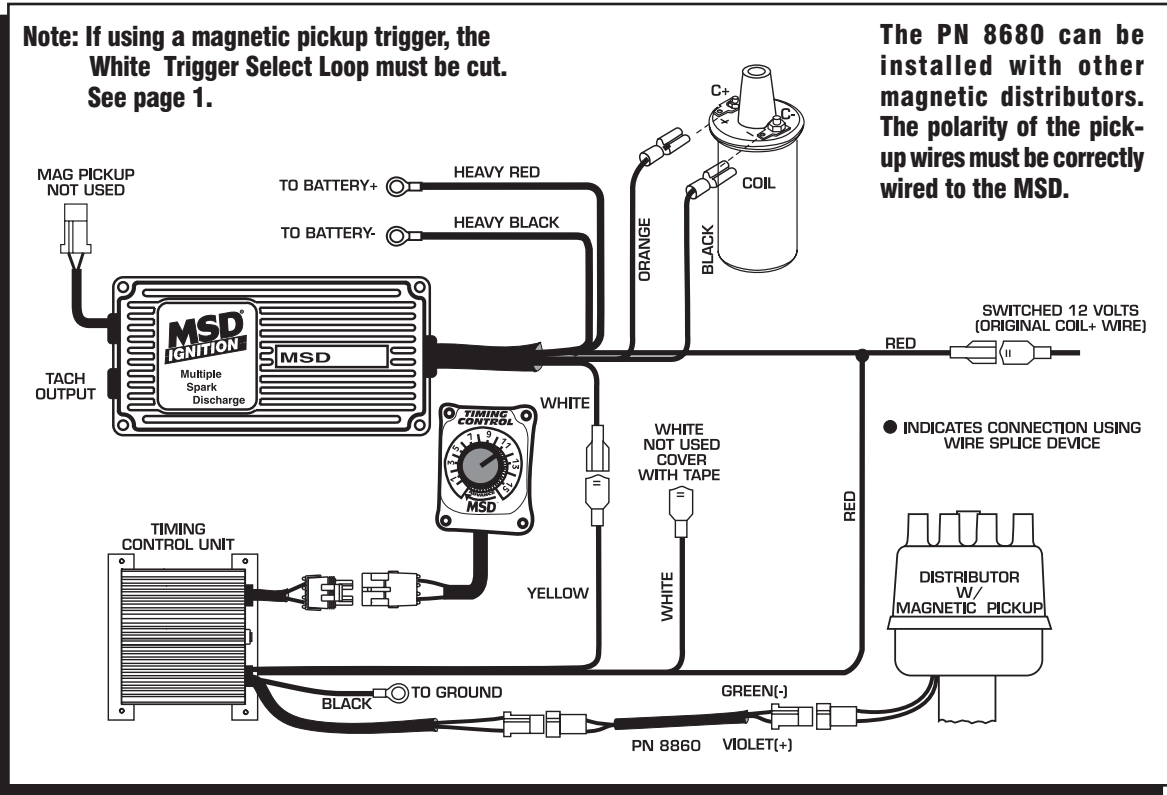

Figure 7 Wiring to Magnetic Pickup Trigger with an MSD 6 Series.

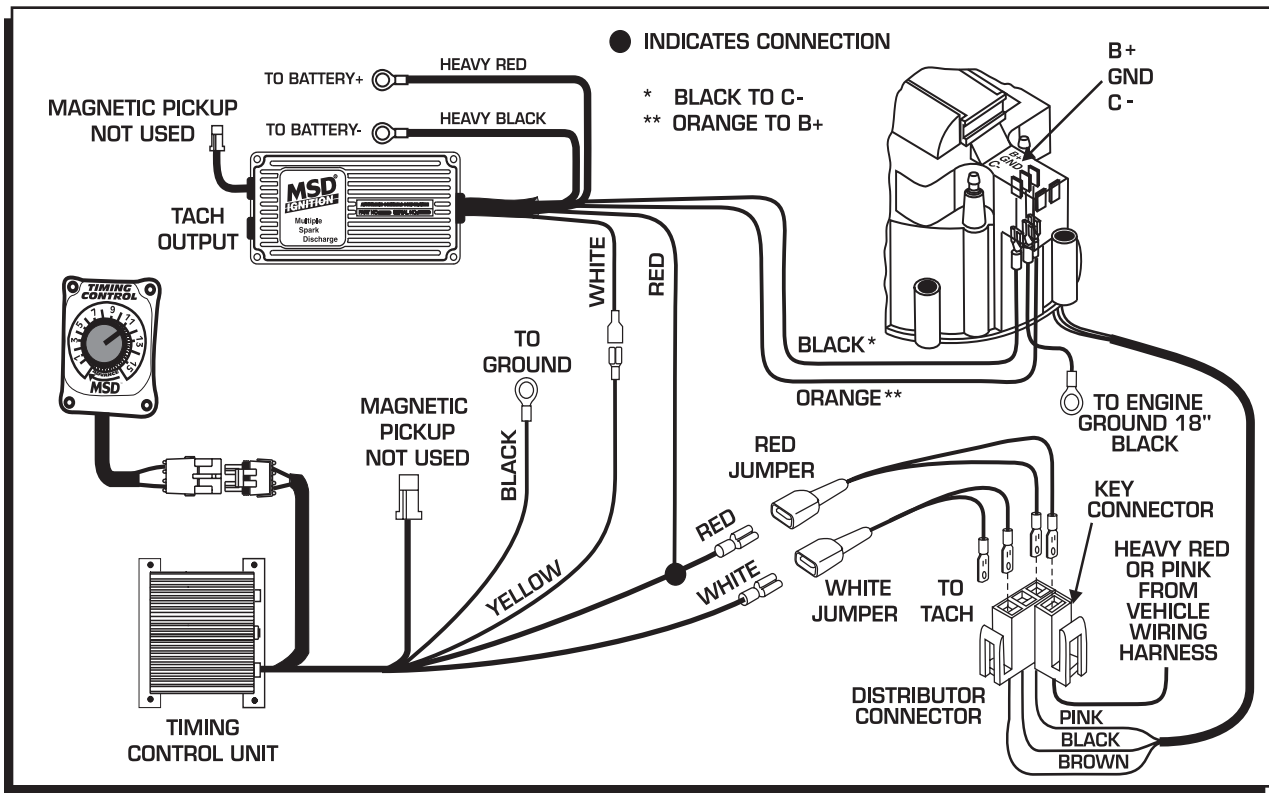

Figure 8 Installation to a GM HEI with a 5 or 7-Pin Module (Points Trigger).

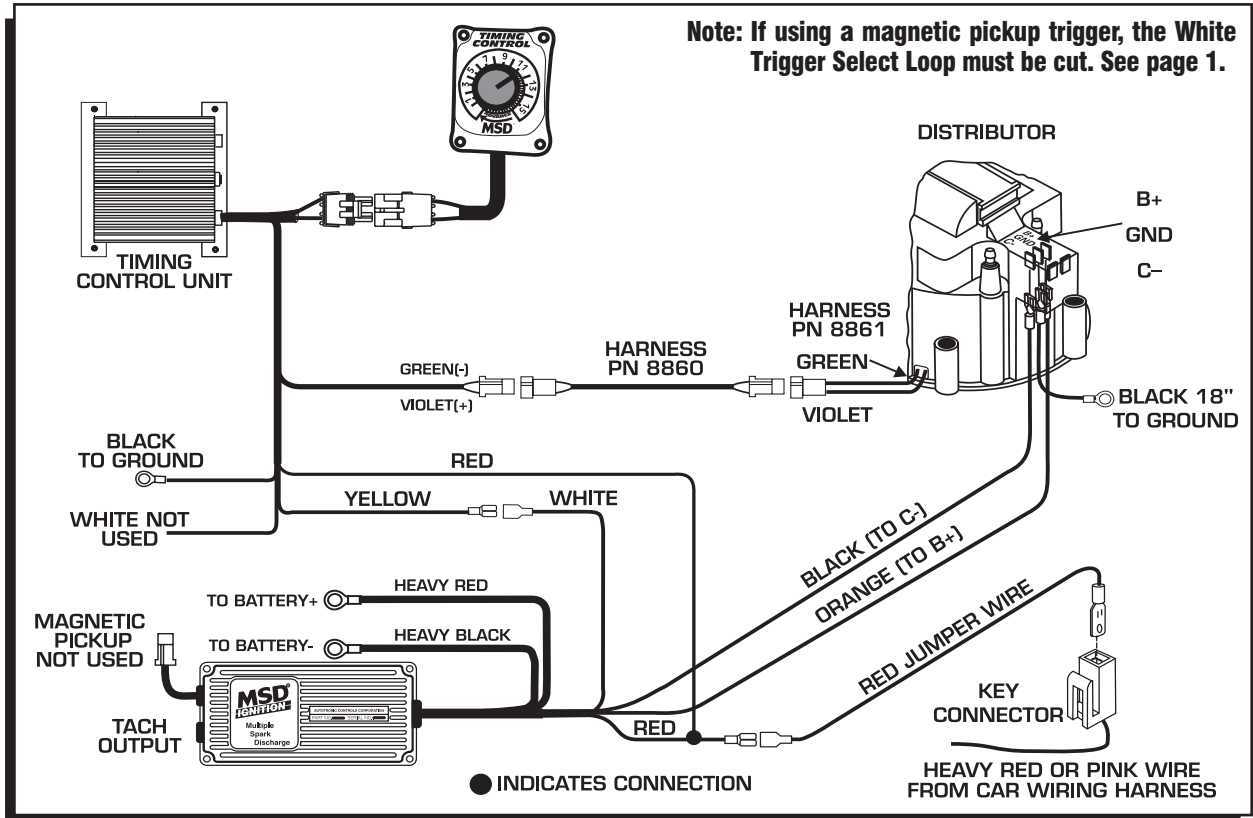

Figure 9 Installation to a GM HEI with a 4-Pin Module (Magnetic Trigger).

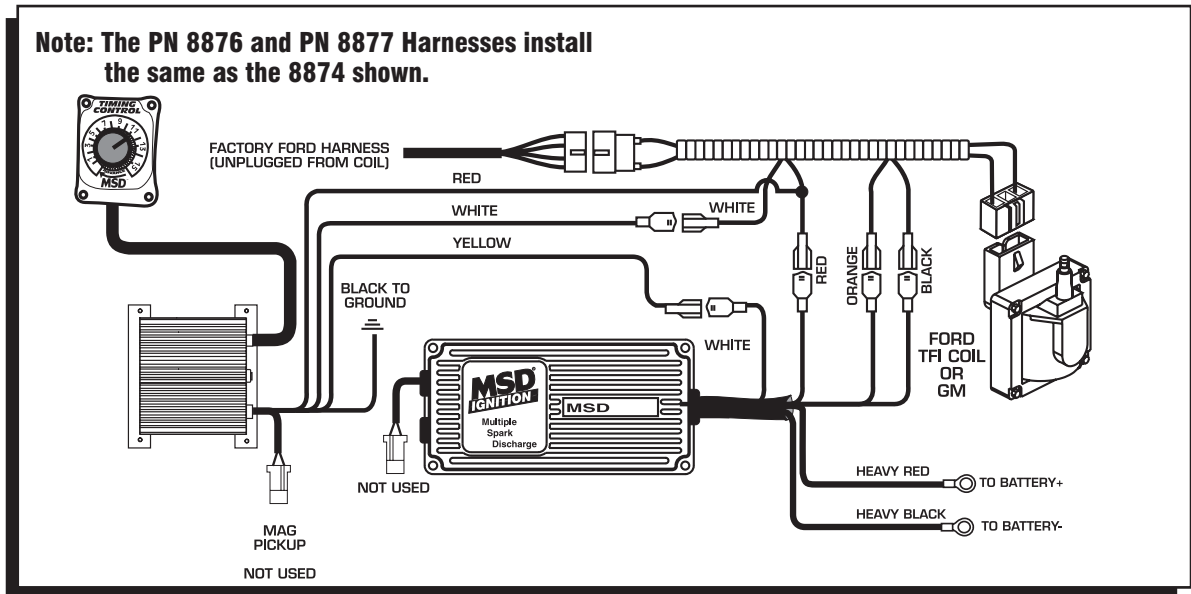

Figure 10 Wiring with an MSD PN 8874, 8876 or 8877 Harness.

Note: The MSD 6 and 7 Series Ignitions share the same wire colors.

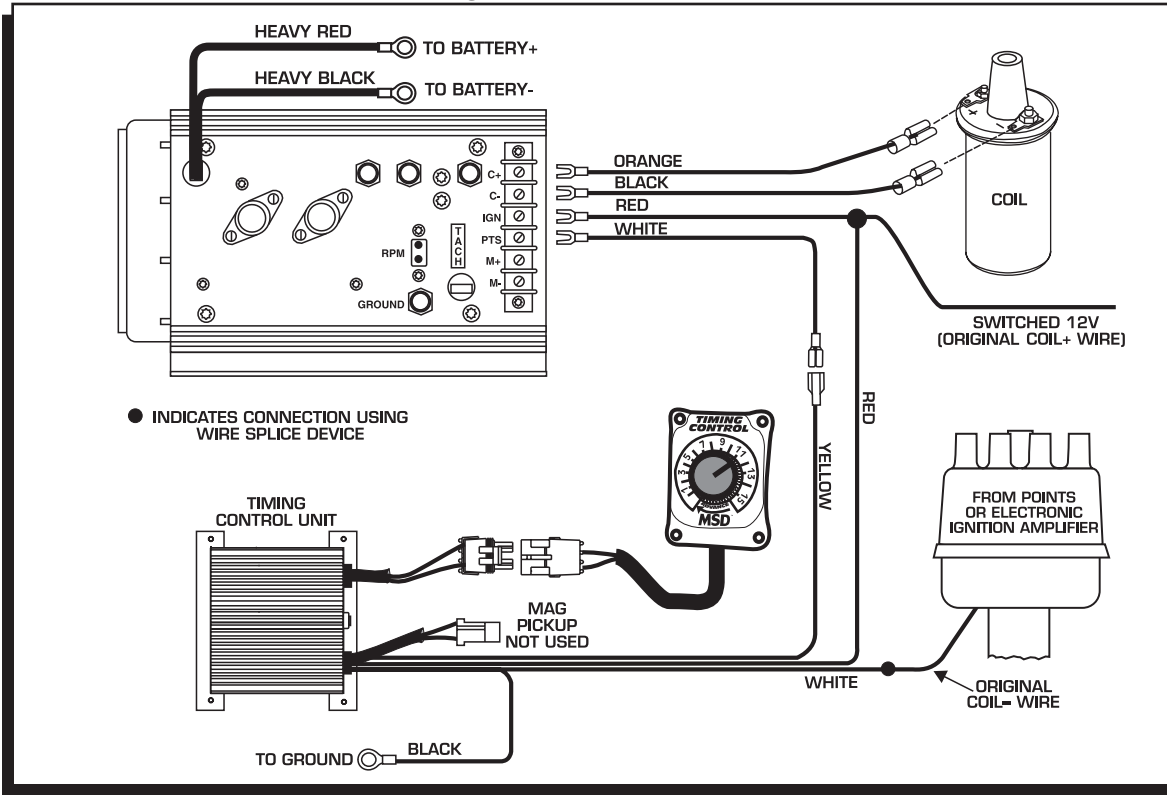

Figure 11 Wiring to Points or Amplifier with an MSD 7 Series.

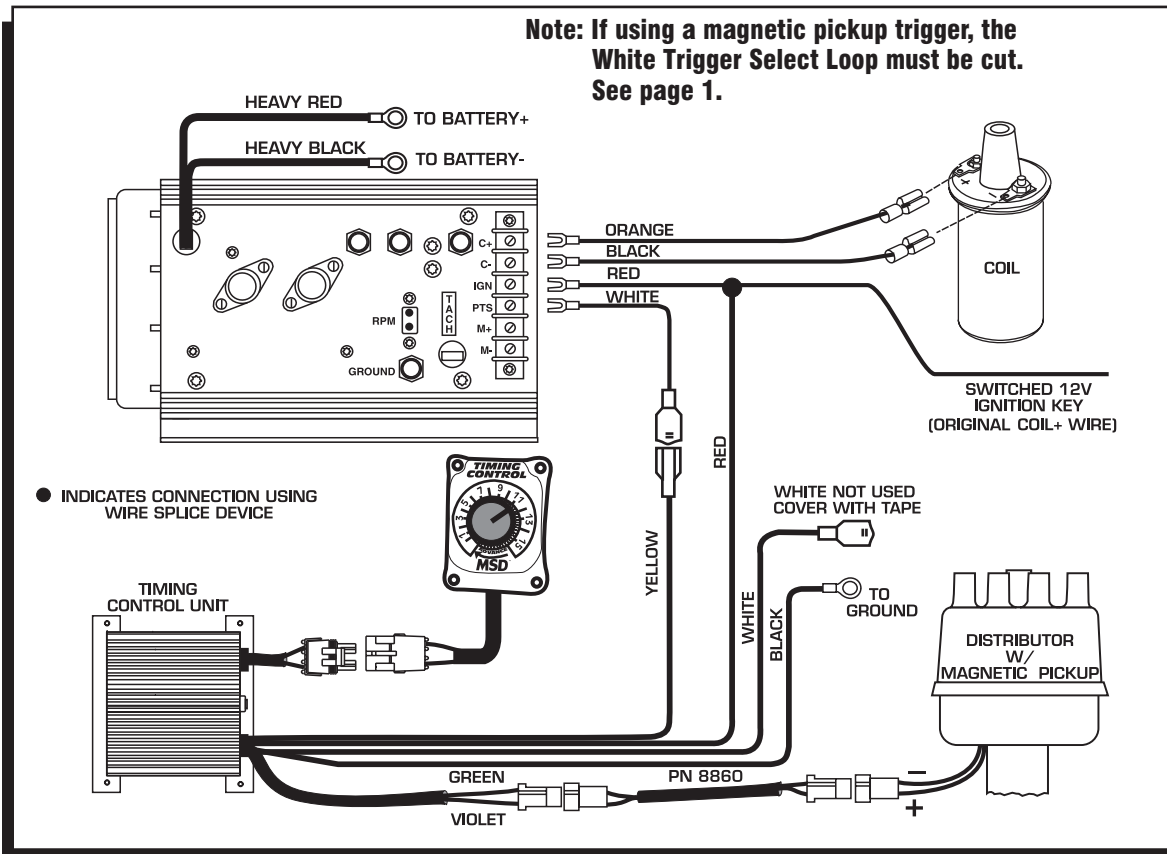

Figure 12 Wiring to Magnetic Pickup with an MSD 7 Series.

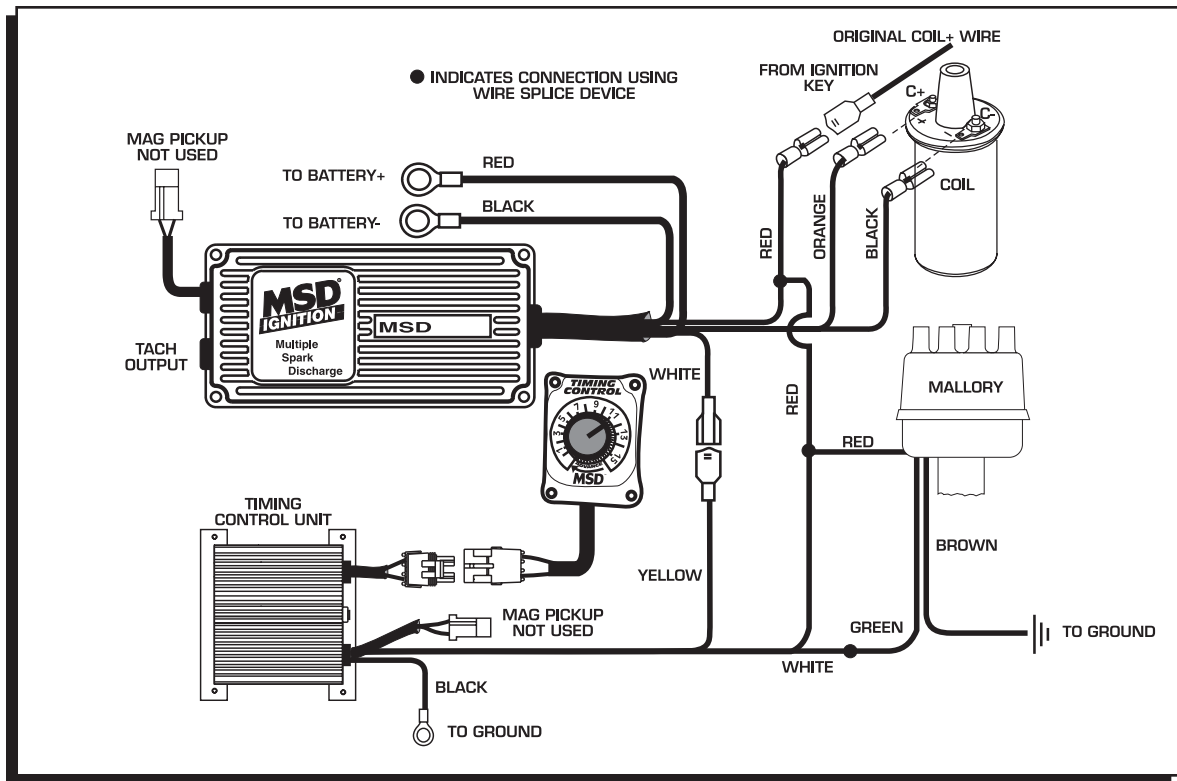

Figure 13 Wiring to a Mallory 3-Wire Distributor.

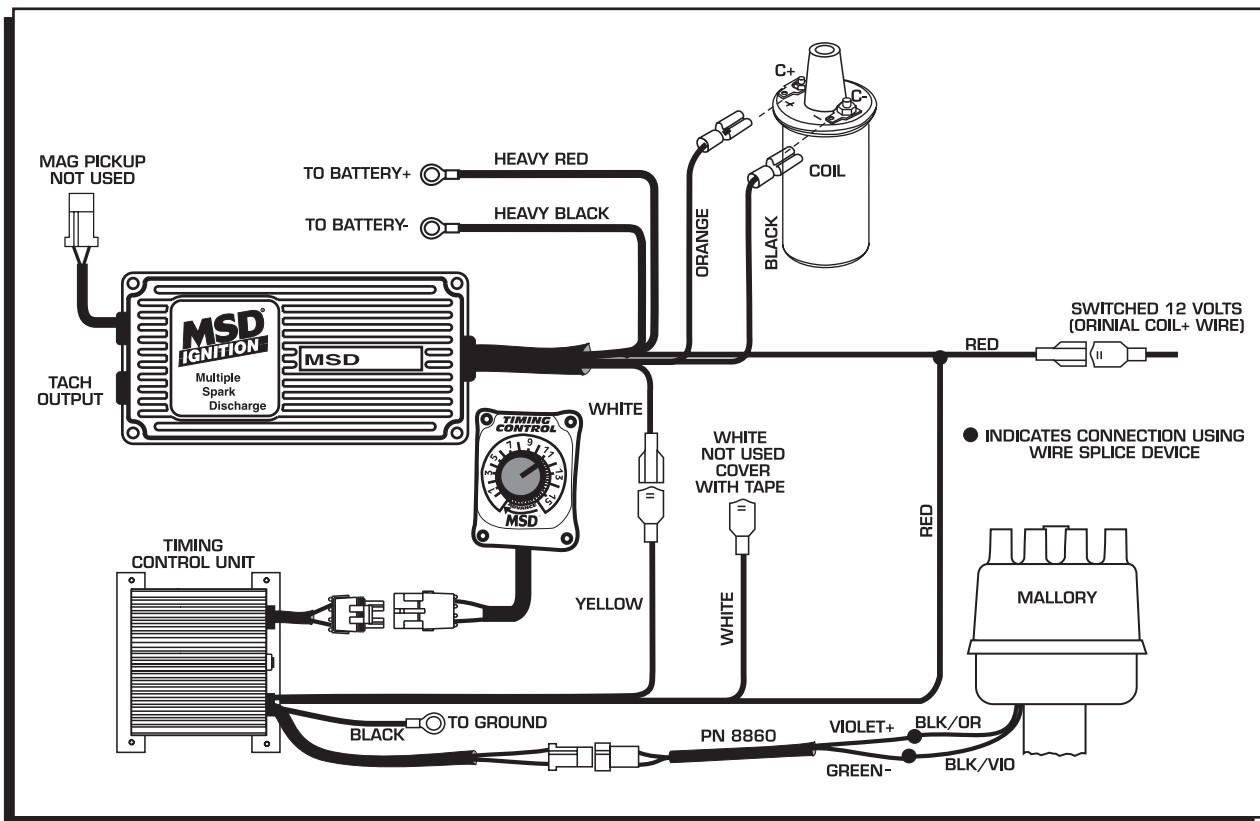

Figure 14 Wiring to a Mallory Distributor w/ Mag Pickup.

TECH NOTES

Service

In case of malfunction, this MSD component will be repaired free of charge according to the terms of the warranty. When returning MSD components for warranty service, **Proof of Purchase** must be supplied for verification. After the warranty period has expired, repair service is based on a minimum and maximum fee.

All returns must have a Return Material Authorization (RMA) number issued to them before being returned. To obtain an RMA number please contact MSD Customer Service at 1 (888) MSD-7859 or visit our website at www.msdisignition.com/rma to automatically obtain a number and shipping information.

When returning the unit for repair, leave all wires at the length in which you have them installed. Be sure to include a detailed account of any problems experienced, and what components and accessories are installed on the vehicle. The repaired unit will be returned as soon as possible using Ground shipping methods (ground shipping is covered by warranty). For more information, call MSD Ignition at (915) 855-7123. MSD technicians are available from 7:00 a.m. to 6:00 p.m. Monday - Friday (mountain time).

Limited Warranty

MSD IGNITION warrants this product to be free from defects in material and workmanship under its intended normal use*, when properly installed and purchased from an authorized MSD dealer, for a period of one year from the date of the original purchase. This warranty is void for any products purchased through auction websites. If found to be defective as mentioned above, it will be repaired or replaced at the option of MSD Ignition. Any item that is covered under this warranty will be returned free of charge using Ground shipping methods.

This shall constitute the sole remedy of the purchaser and the sole liability of MSD Ignition. To the extent permitted by law, the foregoing is exclusive and in lieu of all other warranties or representation whether expressed or implied, including any implied warranty of merchantability or fitness. In no event shall MSD Ignition or its suppliers be liable for special or consequential damages.

*Intended normal use means that this item is being used as was originally intended and for the original application as sold by MSD Ignition. Any modifications to this item or if it is used on an application other than what MSD Ignition markets the product, the warranty will be void. It is the sole responsibility of the customer to determine that this item will work for the application they are intending. MSD Ignition will accept no liability for custom applications.