

MSD[®] IGNITION INSTALLATION INSTRUCTIONS

3-Stage Retard PN 8970

IMPORTANT: Read the Instructions before attempting the installaiton.

Parts Included:

1 - 3-Stage Retard Control
4 - Mounting Grommets

4 - Mounting Screws
6 - Retard Modules, 2°, 3°, 4°, 3-Zero°

WARNING: During installation disconnect the battery cables. When disconnecting the battery, always remove the negative cable first and connect it last.

Note: The 3-Stage Retard Control must be used with an MSD Ignition Control.

Note: When the Three Stage Retard Control is installed the ignition timing will retard approximately 4° from its original setting. After installation, the timing should be checked and adjusted as necessary.

OPERATION

The 3-Stage Retard Control can retard the timing three different times and each with an individual amount. The three amounts are cumulative and the maximum amount of retard is 25°. Each retard stage is activated when its corresponding activation wire is **removed** from ground and the retard will remain activated until the wire is grounded again. There is also a Start Retard circuit that will retard the timing 10° or 25° during cranking to ease starting on engines with locked-out timing or crank triggers.

CYLINDER SELECT

The 3-Stage Retard Control is programmed at the factory for 8-cylinder engines. It can easily be modified for use on 4 and 6-cylinder engines. The number of cylinders is selected by cutting the Cylinder Select Loops as shown in Figure 1.

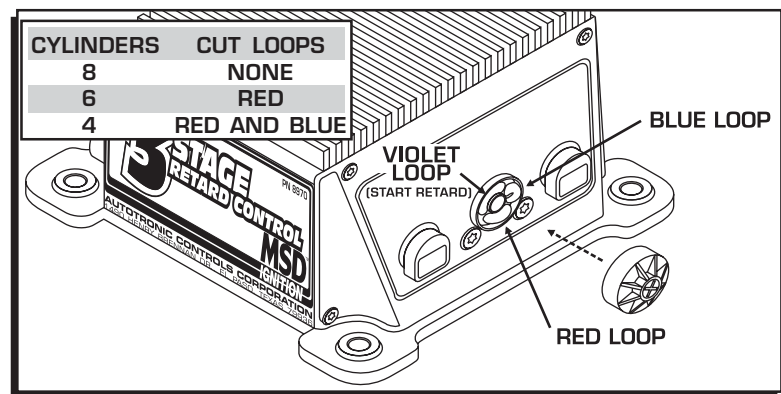

Figure 1 Selecting the Number of Cylinders.

MOUNTING

The 3-Stage Retard Control can be mounted under the hood but should be away from direct engine heat sources. Make sure that the wiring reaches their connections. Before mounting the control, install the supplied rubber grommets into the end panels. Then install the sleeve with the beveled edge facing down (Figure 2).

Use the Control as a template and mark the mounting holes. Use an 1/8" bit to drill the mounting holes.

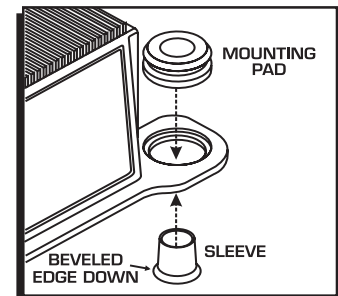

Figure 2 Installing the Vibration Mounts.

WIRING	
RED	This is the On/Off wire. Connects to switched 12 volts.
BLACK	Connects to Ground.
YELLOW	Trigger output. Connects to the MSD Ignition's White Wire.
TRIGGER INPUTS	
There are two input trigger circuits. The wires will never be connected at the same time.	
WHITE	Connects to points or the amplifier trigger wire.
GREEN/VIOLET 2-Pin Connector	Connects to the magnetic pickup of the distributor or crank trigger. Green is negative, Violet is positive.
RETARD CONTROL WIRES	
BROWN	Retard 1, Activated when removed from ground.
ORANGE	Retard 2, Activated when removed from ground.
GRAY	Retard 3, Activated when removed from ground.
START RETARD WIRES	
VIOLET	This wire activates the start retard. When 12 volts are supplied, the timing is retarded during cranking.
VIOLET LOOP	This programs the start retard for either 10° or 25° of retard. The unit is set for 10° at the factory and this loop must be cut to obtain 25°.

The Retard Control wires activate the corresponding retard stage. The retard amount is activated when its wire is **removed from ground**. If you do not plan on using each stage, the corresponding wire must be grounded or a Zero degree module must be installed.

When more than one are activated, the retard is the sum of the modules ($6^\circ + 4^\circ + 8^\circ = 18^\circ$). The maximum retard is 25°.

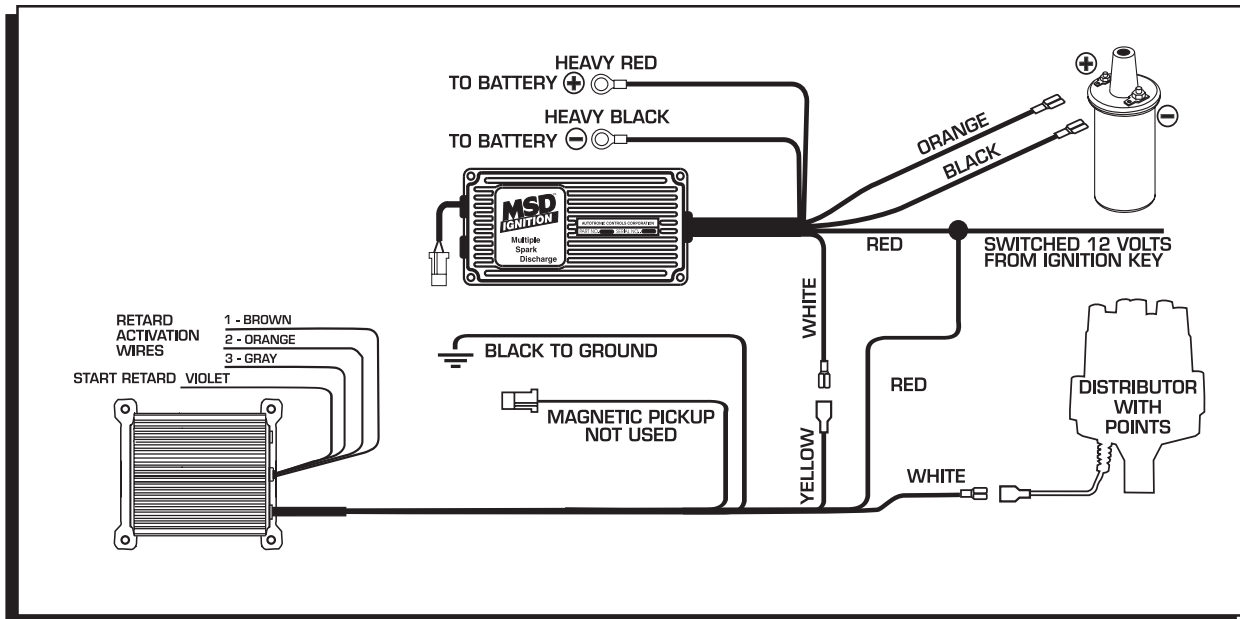

Figure 3 Wiring an MSD 6 Series Ignition with Points/Amplifier.

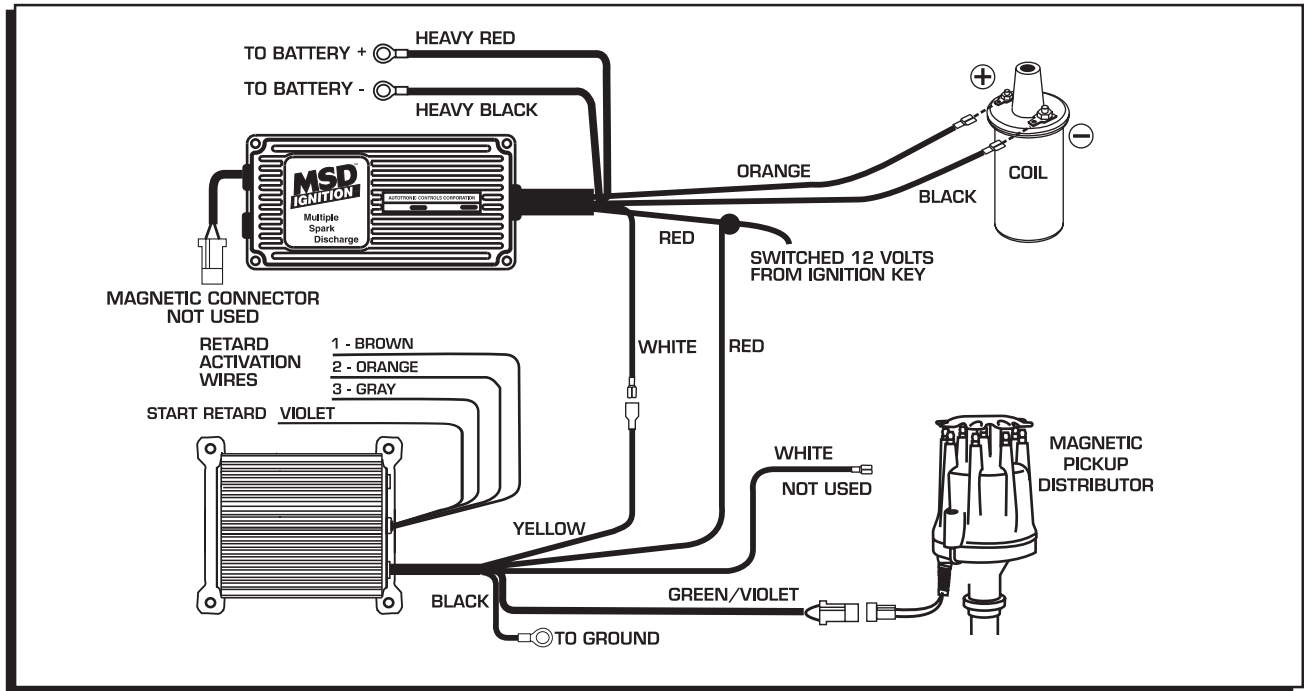

Figure 4 Wiring an MSD 6 Series Ignition with a Mag Pickup.

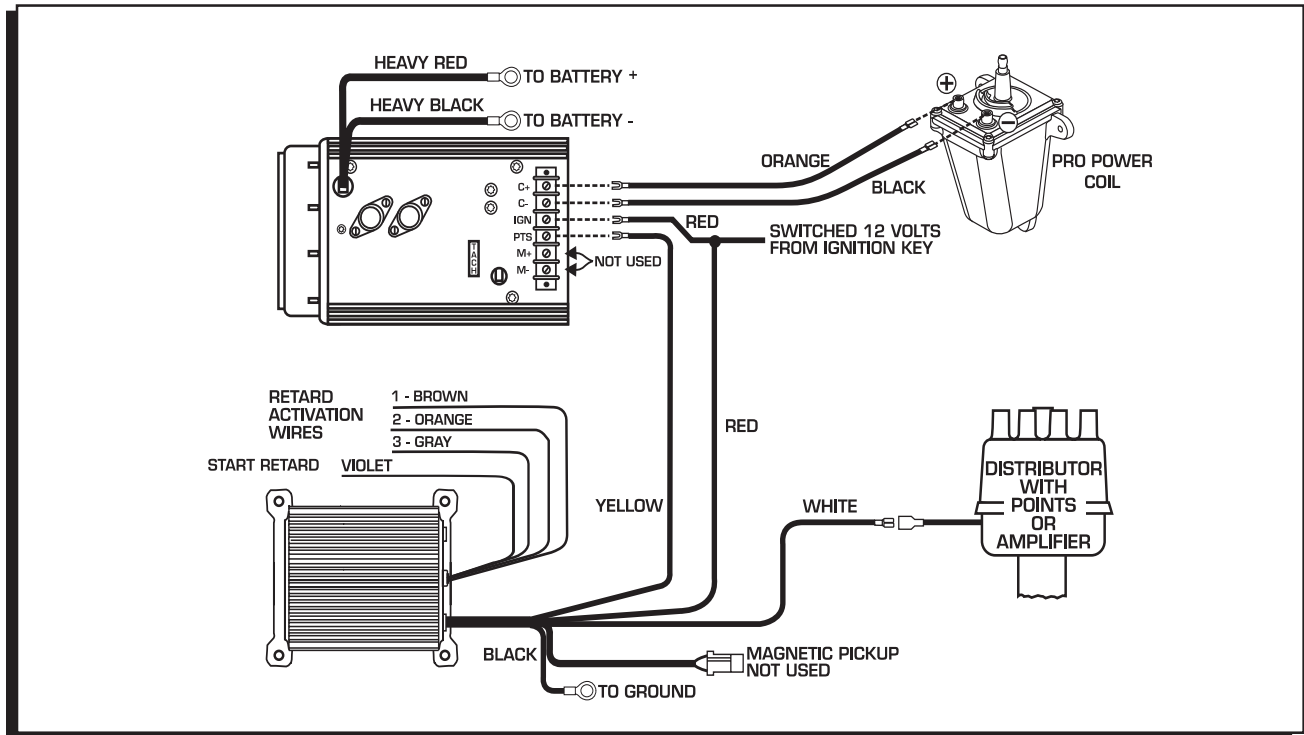

Figure 5 Wiring an MSD 7 Series Ignition with Points/Amplifier.

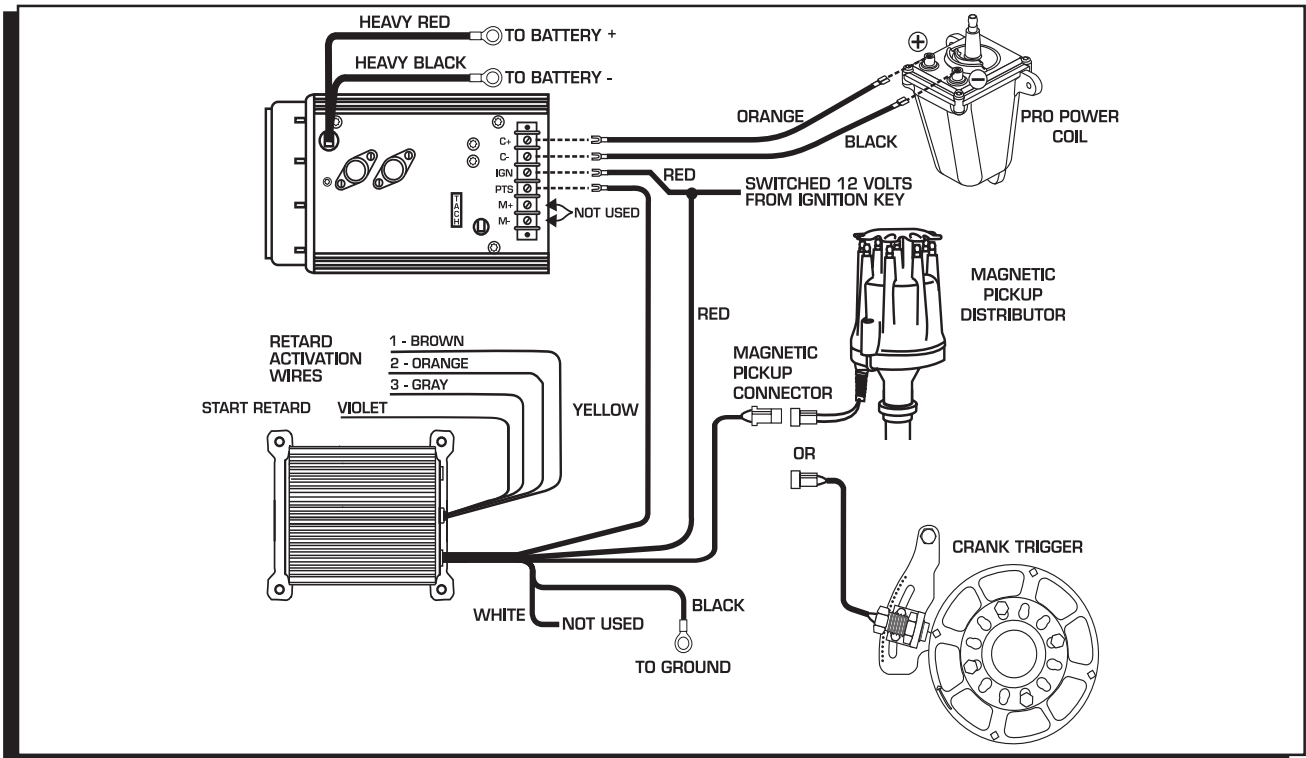

Figure 6 Wiring an MSD 7 Series Ignition with a Mag Pickup.

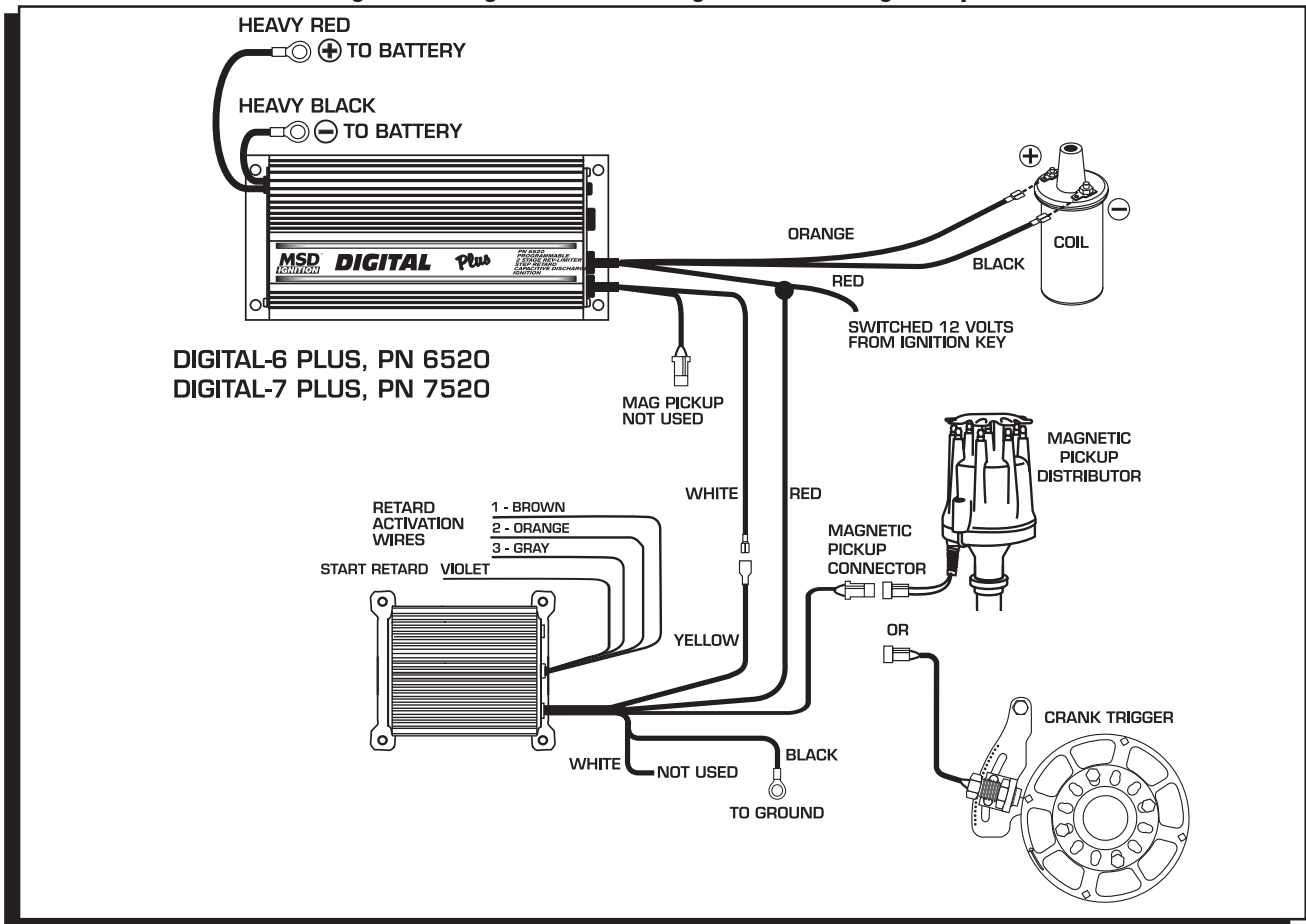

Figure 7 Wiring a Digital 6-Plus or 7-Plus Ignition with a Mag Pickup.

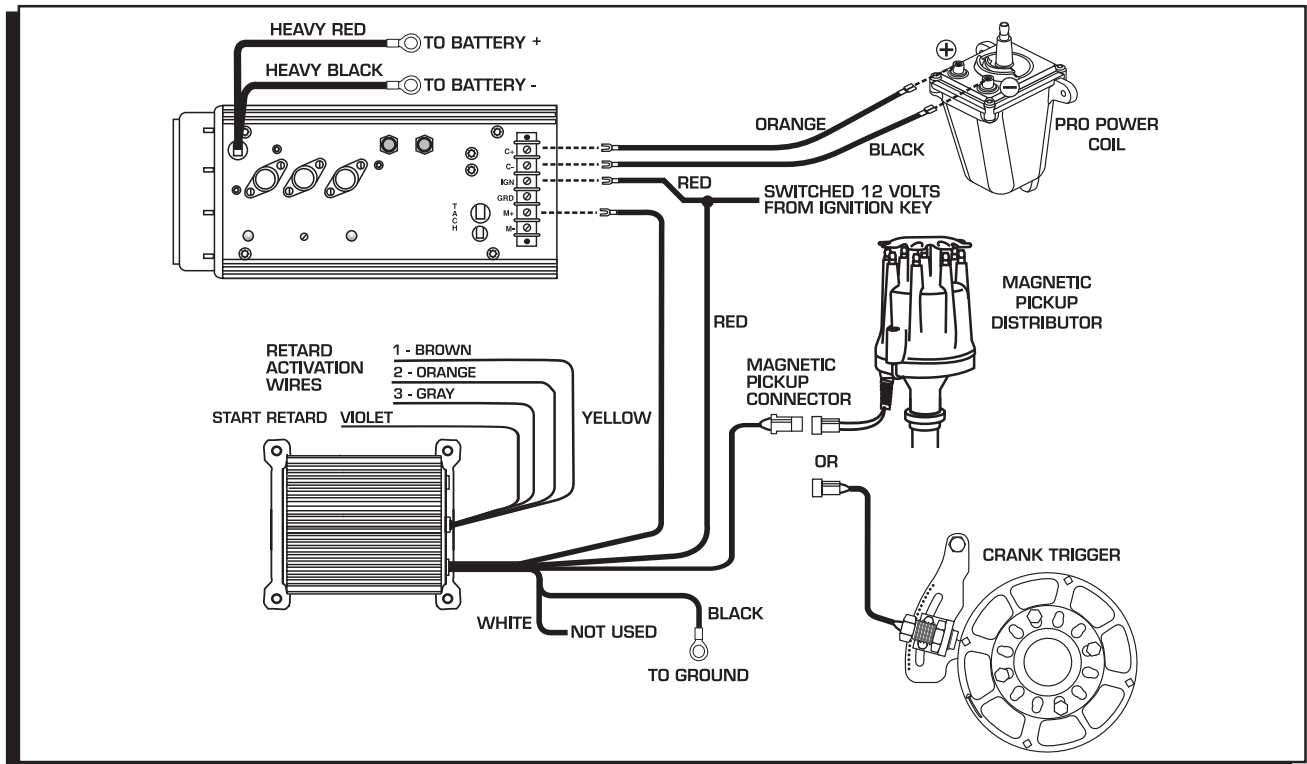

Figure 8 Wiring to an MSD 8 with a Mag Pickup.

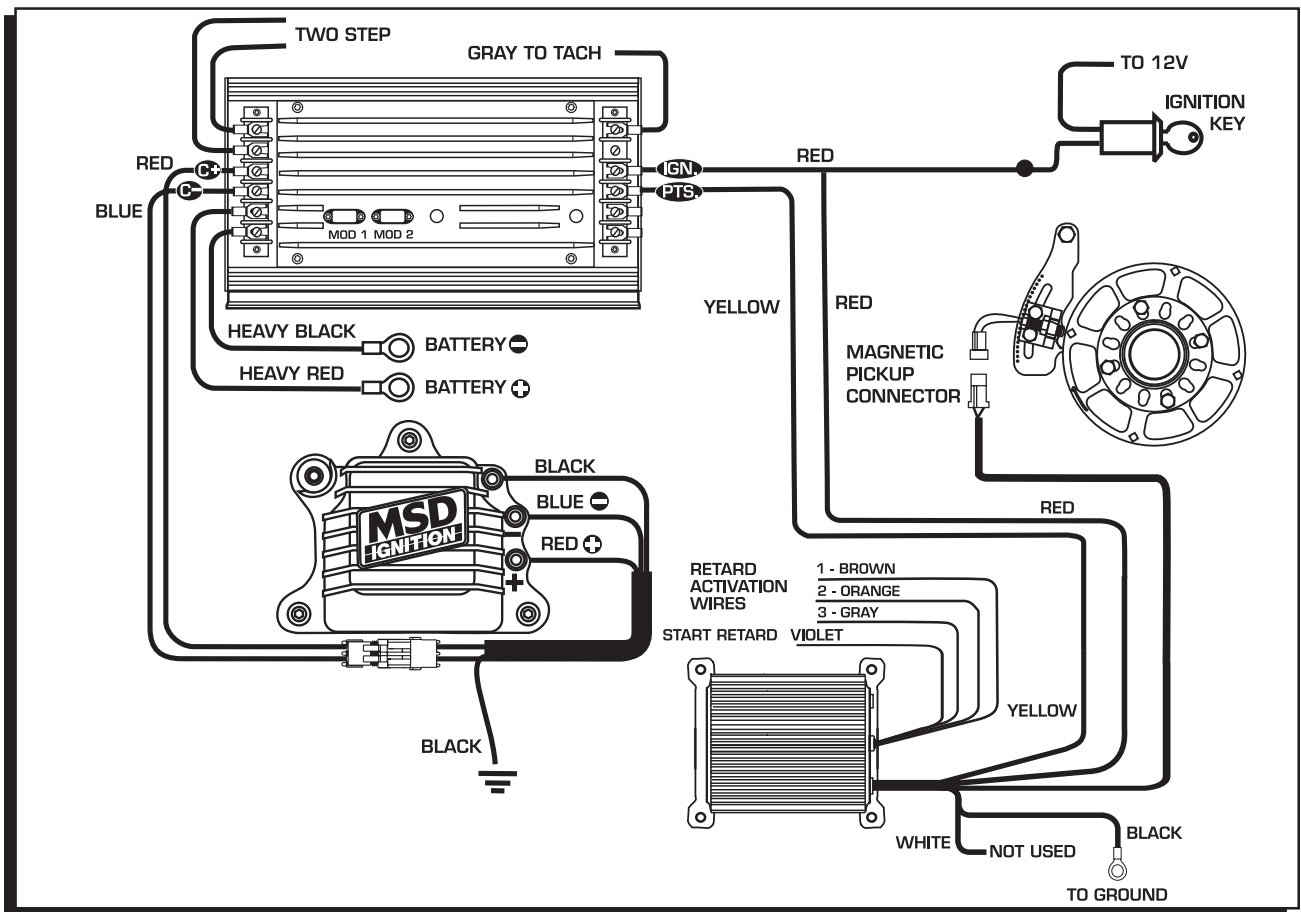

Figure 9 Wiring an MSD 10 PLUS with a Mag Pickup.

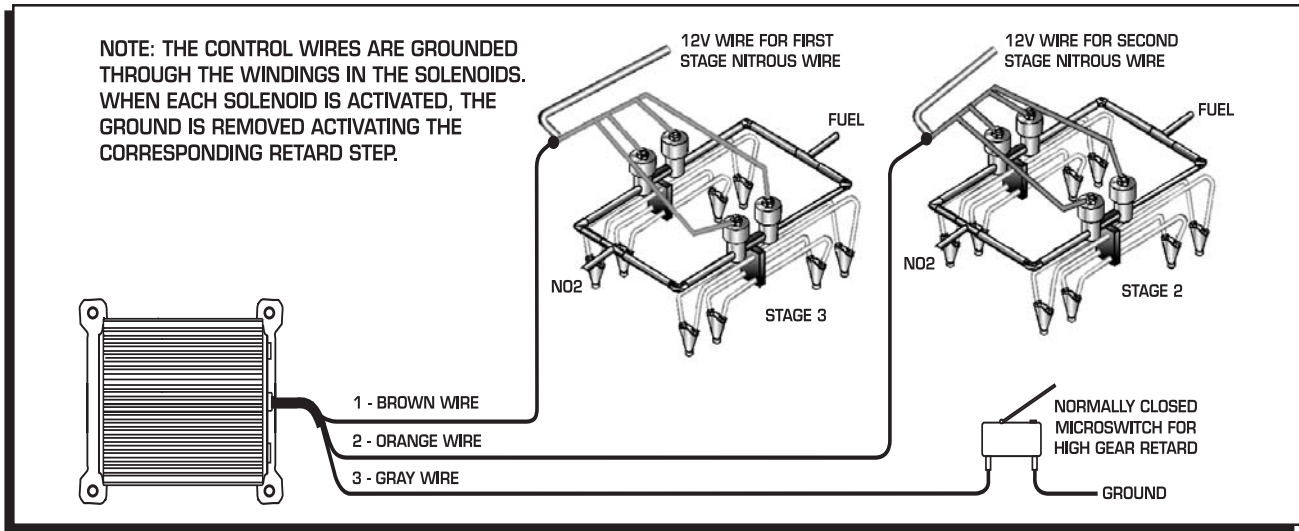

Figure 10 Wiring a Complete Retard System.

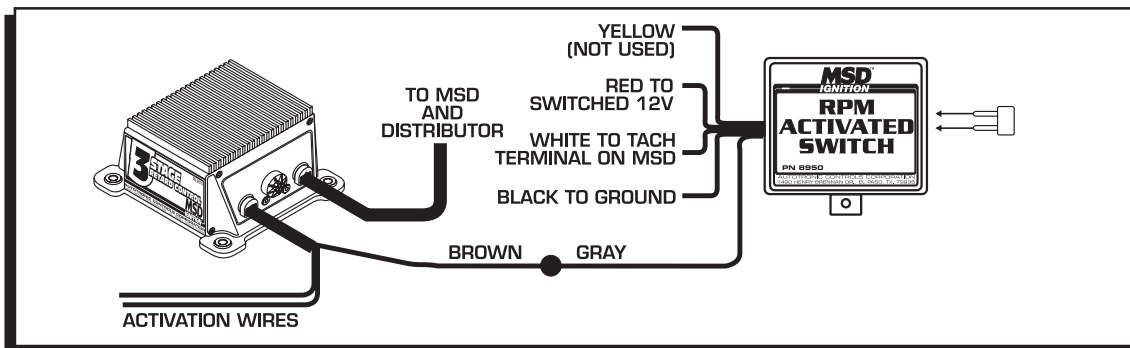

Figure 11 Activation with an RPM Activated Switch.

START RETARD

The Start Retard function is set up at the factory to retard the timing 10° during cranking. It can be modified to retard 25° by cutting the Violet wire loop (Figure 1). The timing will be retarded from the set mechanical amount of the distributor or crank trigger position.

The Violet wire is responsible for activating the Start Retard circuit. When activated, the Start Retard function will retard the timing 10° or 25° while the engine is cranking. There are two ways to connect this circuit:

A. Constant 12 Volts

In this setup the Violet wire is connected to a switched 12 volt source. Whenever the ignition is turned On, 12 volts is applied and the retard function is activated. The retard will be deactivated when the engine reaches approximately 1,300 rpm and will not occur again until the ignition is turned **Off (or drops below 400 rpm)**.

B. Cranking Only:

In this setup, the timing is retarded only when the engine is cranking. Connect the Violet wire directly to the starter solenoid. When the key is turned to the Crank position, 12 volts is applied to the Violet wire, activating the retard. When the key is released, 12 volts is removed and the timing returns to your run timing.

Note: The Start Retard circuit overrides the three retard stages.

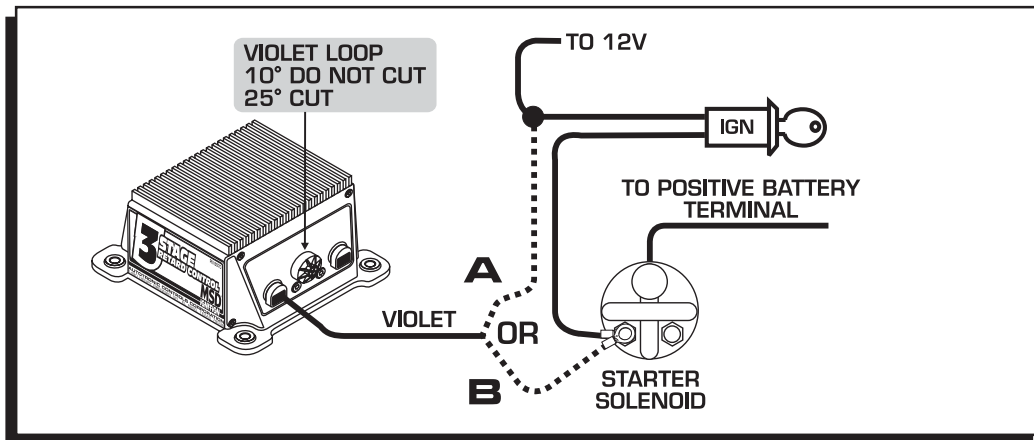

Figure 12 Wiring the Start Retard Function.

