



These instructions can be found in color and expandable at QA1.net

Technical Support Line: (952) 985-5675 Email: sales@QA1.net

INSTALLATION INSTRUCTIONS

QA1 P/N 5297, 5298 Adjustable Upper Trailing Arms
'65-'70 Chevrolet Impala, Caprice, Belair, Biscayne

TOOLS AND SUPPLIES REQUIRED

- Floor Jack
- SAE Wrench/Socket Set
- Tire Chocks
- Jack Stands
- Torque Wrench

PRE INSTALLATION NOTES:

These arms are sold individually due to some '65-'70 cars being a three-link, single upper trailing arm while other '65-'70 cars use a four-link rear suspension using two upper trailing arms.

Owners of 1968 cars should check the upper control arm length before beginning this installation. 1965-1968 cars use 12-13/16" long upper control arms while 1969 & 1970 cars use a shorter 10" upper control arm. Some 1968 cars will use the shorter '69-'70 arms.

QA1 offers both long and short upper trailing arms in a tubular (fixed) design as well as an adjustable version.

PART NUMBER	YEAR	DESCRIPTION	LENGTH
5295	1965-1968	Tubular Upper Control Arm, (fixed)	12.81"
5296	1969-1970	Tubular Upper Control Arm, (fixed)	10.00"
5297	1965-1968	Adjustable Upper Control Arm	12.25" - 13.81"
5298	1969-1970	Adjustable Upper Control Arm	9.75" - 11.50"

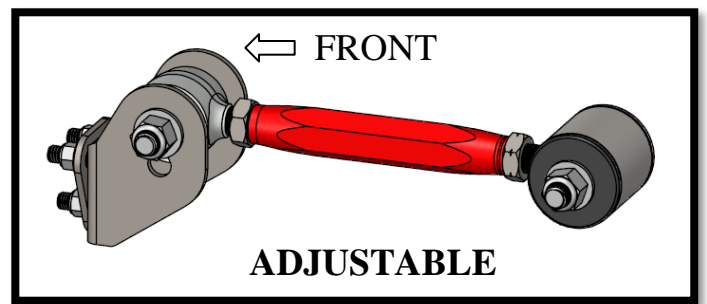
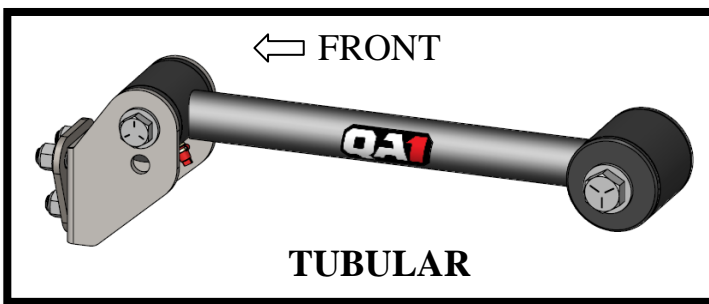

DISASSEMBLY:

1. Chock the front tires and jack the rear of the car up.
2. Securely set the rear of the car on jack stands.
3. Support the rear pinion using a jack stands or a floor jack.
4. Remove the three front trailing arm bracket nuts from the backside of the crossmember using an 11/16" socket or wrench. **(Figure 1)** If the car has two upper trailing arms it is suggested to remove/install one at a time.

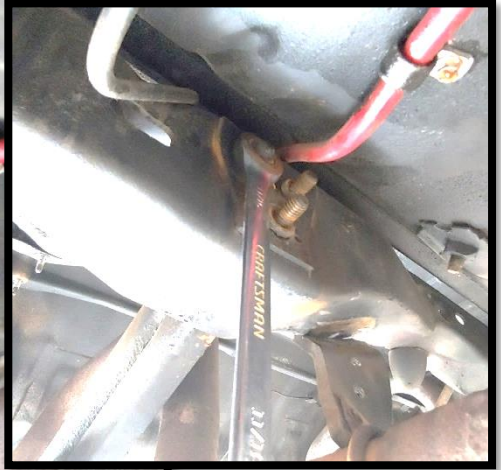
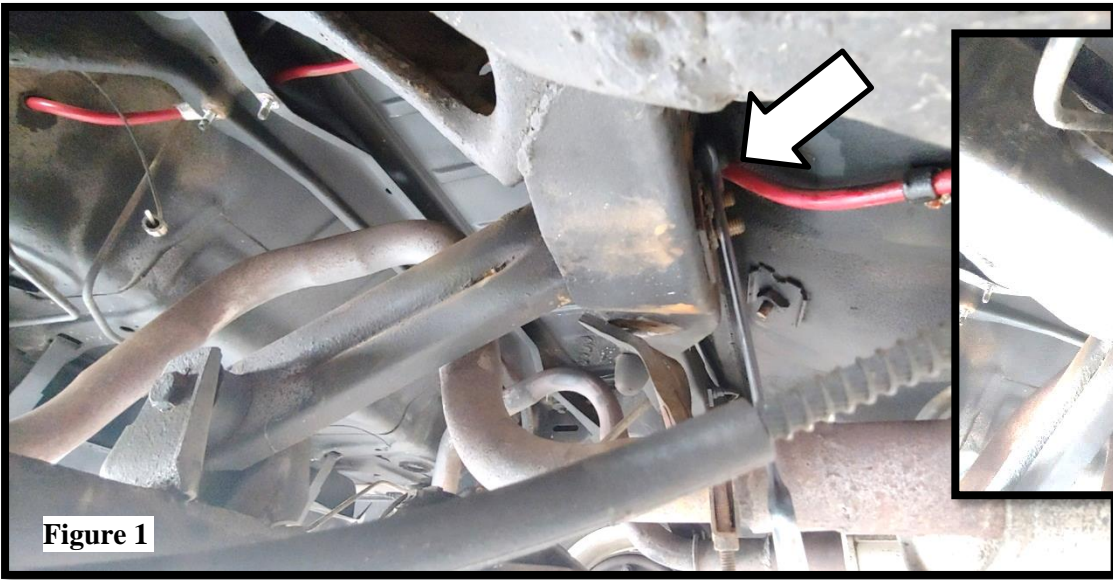

Figure 1

5. Remove the upper trailing arm mount from the axle. **(Figure 2)**
6. Remove the trailing arm from the car.

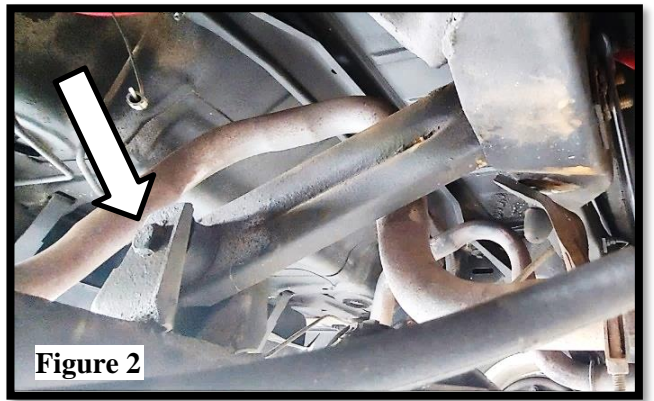

Figure 2

INSTALLATION:

1. Ensure the front and rear trailing arm mounting surfaces are clean and free of debris. Part reference numbers refer to the exploded diagram on page 3.
2. Using the included frame mount and backing plate (#1), install the front mount using the 7/16" x 1.25" hardware (#11.1) with two washers (#11.2) and nylock nut (#11.3). Torque to 42 lb. ft. **(Figure 3)**

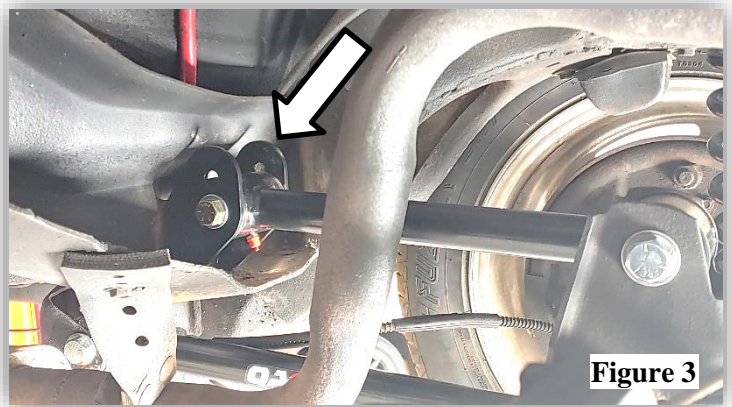
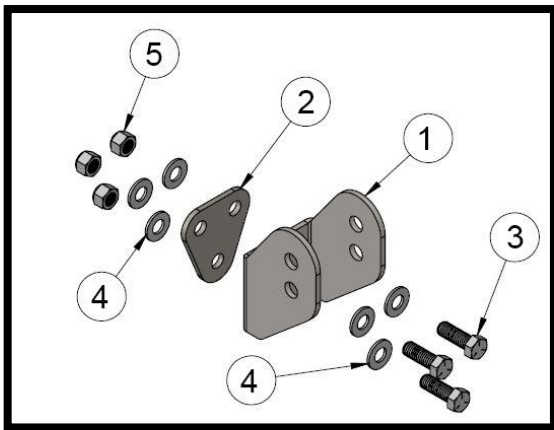
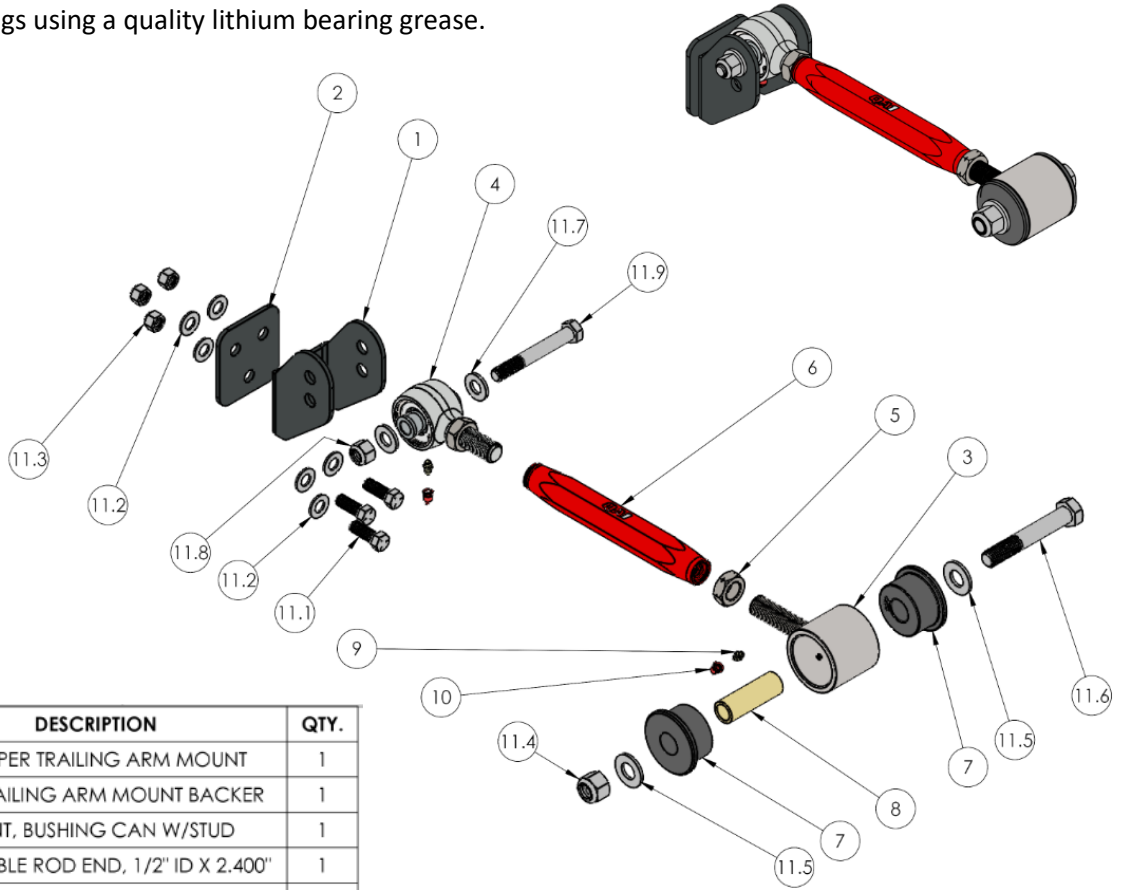

Figure 3

BALLOON	DESCRIPTION
1	PLATE, UPPER TRAILING ARM MOUNT
2	BACKING PLATE, UPPER TRAILING ARM MOUNT
3	BOLT, 7/16"-14 x 1.25"
4	WASHER, SAE 7/16"
5	NUT, NYLOCK 7/16"-14

3. Adjust the trailing arm to the factory length of 12-7/8" center to center and tighten the jam nuts against the red anodized sleeve.
4. Install the rod end (#4) side of the trailing arm into the lower hole (factory position) of the frame bracket with the grease fitting facing down. Fasten using 1/2" x 3.75" bolt (#11.9) with two washers (#11.7) and nylock nut (#11.8). The bracket has an additional hole 1" higher to correct the suspension geometry with lowered ride heights.
5. Install the bushing end of the arm (#3) to the axle mount with the grease fitting facing down. Fasten using 5/8" x 4" bolt (#11.6), two washers (#11.5) and nylock nut (#11.4).
6. Set the vehicle at ride height and torque the front connection to 50 lb. ft. and the axle connection to 90 lb. ft.
7. Loosen the jam nuts and adjust the pinion angle as needed before re-tightening the jam nuts.
8. Lightly grease all zerk fittings using a quality lithium bearing grease.



BALLOON #	ITEM #	DESCRIPTION	QTY.
1	9637-375	PLATE, UPPER TRAILING ARM MOUNT	1
2	9637-376	PLATE, TRAILING ARM MOUNT BACKER	1
3	9637-377	WELDMENT, BUSHING CAN W/STUD	1
4	9190-110	REBUILDABLE ROD END, 1/2" ID X 2.400"	1
5	JNL12S	JAM NUT, 3/4-16 LH	1
6	9033-488	SLEEVE, ALUMINUM HEX 8.50"	1
7	9032-411	BUSHING, POLY, .75" ID	2
8	9033-480	SLEEVE, .880", .631", 2.602"	1
9	9023-119	GREASE ZERK, 1/4-28	1
10	9023-116	CAP, GREASE ZERK	1
11	9637-382	HARDWARE KIT, UPPER TRAILING ARM	1
11.1	-	BOLT, 7/16"-14 X 1.25"	3
11.2	-	WASHER, SAE, 7/16"	6
11.3	-	NUT, NYLOCK, 7/16"-14	3
11.4	-	NUT, NYLOCK, 5/8"-11	1
11.5	-	WASHER, SAE, 5/8"	2
11.6	-	BOLT, 5/8"-11 X 4.00"	1
11.7	-	WASHER, SAE, 1/2"	2
11.8	-	NUT, NYLOCK, 1/2-13	1
11.9	-	BOLT, 1/2-13 X 3.75"	1

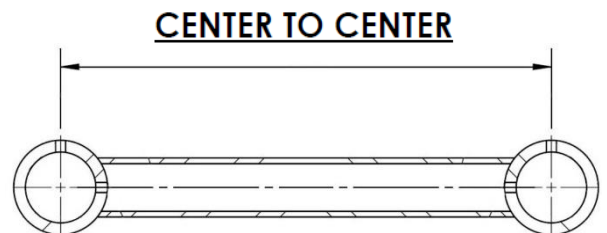



Technical Support Line: (952) 985-5675 Email: sales@QA1.net

READ ALL INSTRUCTIONS CAREFULLY AND THOROUGHLY PRIOR TO STARTING INSTALLATION. PRODUCTS THAT HAVE BEEN INSTALLED ARE NOT ELIGIBLE FOR RETURN. USE THE PROPER JACKING LOCATIONS. DEATH OR SERIOUS INJURY CAN RESULT IF INSTRUCTIONS ARE NOT CORRECTLY FOLLOWED. A GOOD CHASSIS MANUAL, AVAILABLE AT YOUR LOCAL PARTS STORE, MAY ALSO AID IN YOUR INSTALLATION.

• DISCLAIMER / WARRANTY •

QA1 WARRANTS THAT THE PRODUCTS WILL BE FREE FROM DEFECTS IN MATERIAL AND WORKMANSHIP FOR ONE YEAR FROM DATE OF SALE TO THE ORIGINAL PURCHASER. QA1 MAKES NO OTHER WARRANTY OF ANY KIND, EXPRESS OR IMPLIED. QA1 SHALL HAVE NO OBLIGATION UNDER THE FOREGOING WARRANTY WHERE THE DEFECT IS THE RESULT OF IMPROPER OR ABNORMAL USE, YOUR NEGLIGENCE, VEHICLE ACCIDENT, IMPROPER OR INCORRECT INSTALLATION OR MAINTENANCE, NOR WHEN THE PRODUCT HAS BEEN REPAIRED OR ALTERED IN ANY WAY. QA1'S LIABILITY IN THE CASE OF DEFECTIVE PRODUCTS SUBJECT TO THE FOREGOING WARRANTY SHALL BE LIMITED TO THE REPAIR OR REPLACEMENT, AT QA1'S OPTION, OF THE DEFECTIVE PRODUCTS.

THE USER UNDERSTANDS AND RECOGNIZES THAT RACING PARTS, SPECIALIZED STREET ROD EQUIPMENT, AND ALL PARTS AND SERVICES SOLD BY QA1 ARE EXPOSED TO MANY AND VARIED CONDITIONS DUE TO THE MANNER IN WHICH THEY ARE INSTALLED AND USED. QA1 SHALL BEAR NO LIABILITY FOR ANY LOSS, DAMAGE OR INJURY, EITHER TO A PERSON OR TO PROPERTY, RESULTING FROM THE INSTALLATION, DIRECT OR INDIRECT USE OF ANY QA1 PRODUCTS OR INABILITY BY THE BUYER TO DETERMINE PROPER USE OR APPLICATION OF QA1 PRODUCTS. WITH THE EXCEPTION OF THE LIMITED LIABILITY WARRANTY SET FORTH ABOVE, QA1 SHALL NOT BE LIABLE FOR ANY CLAIMS, DEMANDS, INJURIES, DAMAGES, ACTIONS, OR CAUSES OF ACTION WHATSOEVER TO BUYER ARISING OUT OF OR CONNECTED WITH THE USE OF ANY QA1 PRODUCTS. MOTORSPORTS ARE DANGEROUS; AS SUCH, NO WARRANTY OR REPRESENTATION IS MADE AS TO THE PRODUCT'S ABILITY TO PROTECT THE USER FROM INJURY OR DEATH. THE USER ASSUMES THAT RISK!

Dedicated Technical Support Team

QA1 is dedicated to providing quality support and instructions. We employ passionate racers and car enthusiasts that know our products and the industry to better serve you.

Give our tech support line a call at **1.800.721.7761**

Visit online at **www.QA1.net/tech** or **www.YouTube.com/QA1Tech** for:

- Frequently Asked Questions
- Quick Tips
- Install Information
- Tuning and Repair Guides
- Other Technical Information

Our technical support and order lines are open **Monday – Friday, 8 am to 5 pm CST.**

