

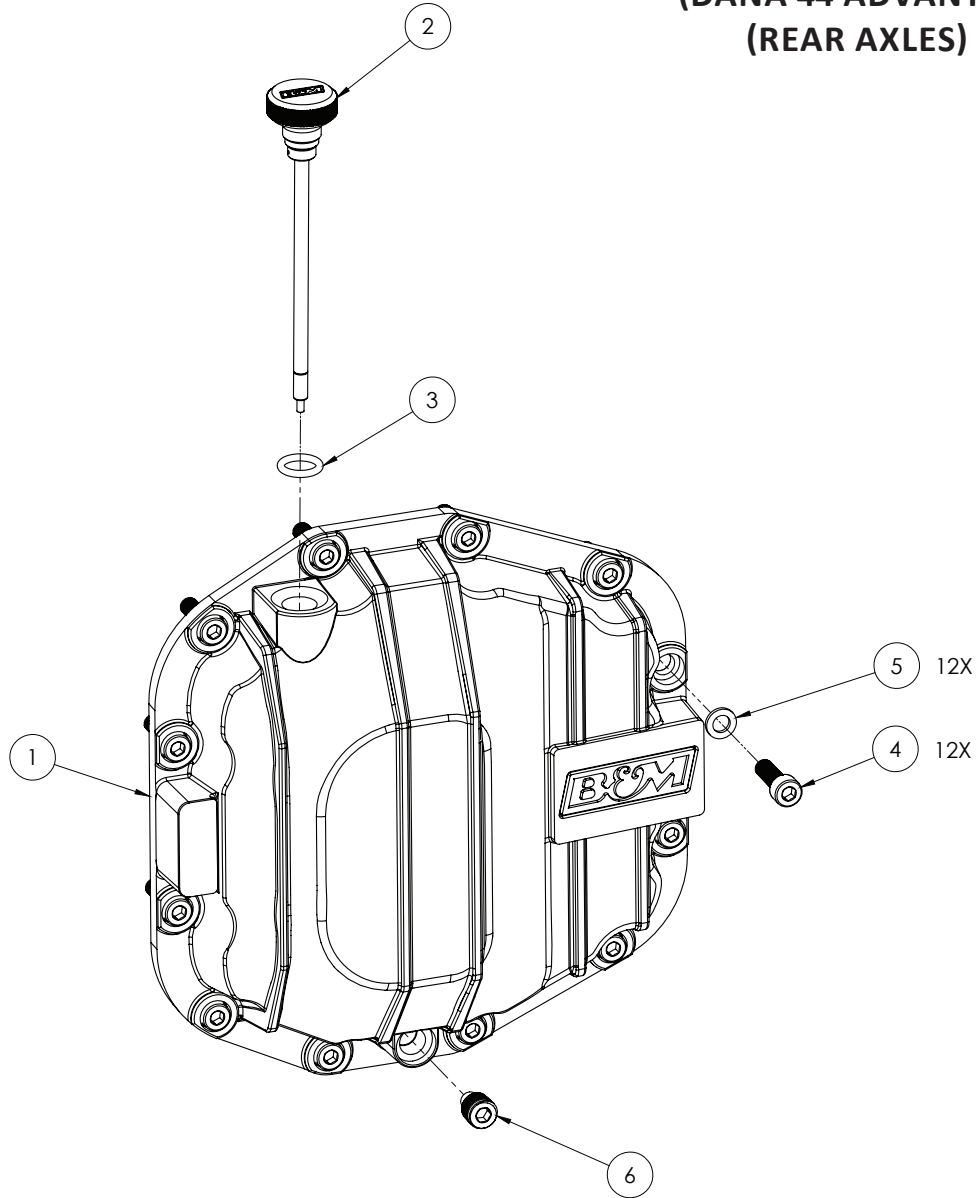

Installation Instructions for  
**12313**  
**DIFFERENTIAL COVER - REAR**  
**2018 WRANGLER JL**  
**FITS: DANA M220**  
**(DANA 44 ADVANTEK)**  
**(REAR AXLES)**



ITEM	PART NO.	DESCRIPTION	QTY.
1	2000312	Iron Rear Differential Cover	1
2	1601019	Differential Cover Dipstick	1
N/A	12313BA	Hardware Pack includes:	1
3	3401151	O-Ring #-207-S-70	1
4	3401128	Screw M8-1.25X25 SOC HD Stainless	12
5	3401479	5/16" AN 960 18-8 SS Washer	12
6	3401482	1/4" NPTF Hex Socket Magnetic Plug	1

## OVERVIEW:

This B&M Differential Cover provides increased fluid capacity and has a thick nodular cast iron construction to increase case rigidity. The magnetic drain plug allows regular gear oil changes and limits ferrous debris from circulating in the axle. It also features a built in dipstick so you can maintain and check your fluid level anytime.

## INSTALL TIME: APPROXIMATELY 1 HOUR

### REQUIRED MATERIALS

- PTFE tape
- Drain Pan
- Transfer Pump
- Differential Fluid

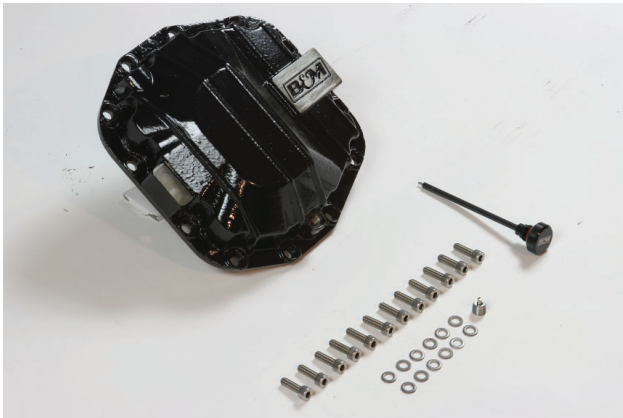

1. Please take a moment to read and understand these instructions before installing your purchased performance kit. Use parts drawing and list to verify kit contents.

## REMOVE FACTORY COMPONENTS:

### WARNING:

Never work under a vehicle supported only by a jack.

2. Raise vehicle up on a hoist or rack to working height. If you don't have access to a hoist or rack, support vehicle with jack stands.

### WARNING:

Avoid serious burns! Allow vehicle time to cool before handling any differential assembly components.



3. Place drain pan under rear differential where it can catch fluid. Remove factory plug and allow fluid to drain. Then remove bolts (x12) and differential cover.

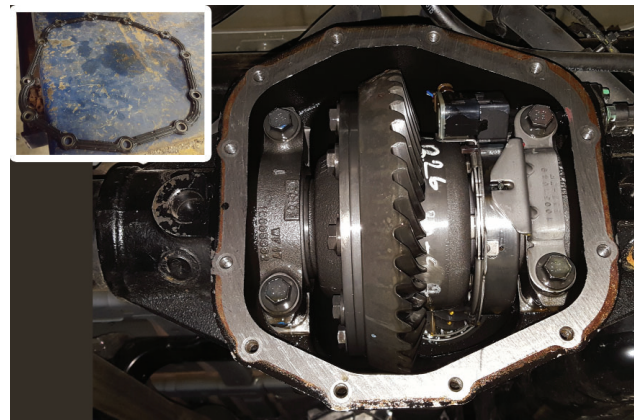

4. Remove and retain gasket from differential cover; wipe it clean and dry. Then clean mounting surface on front differential.

## Install Rear Differential Cover:

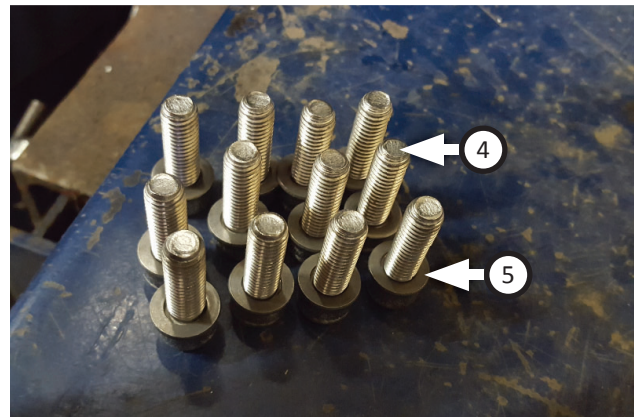

5. Place (x12 ea.) washers (5) onto screws (4) as shown.

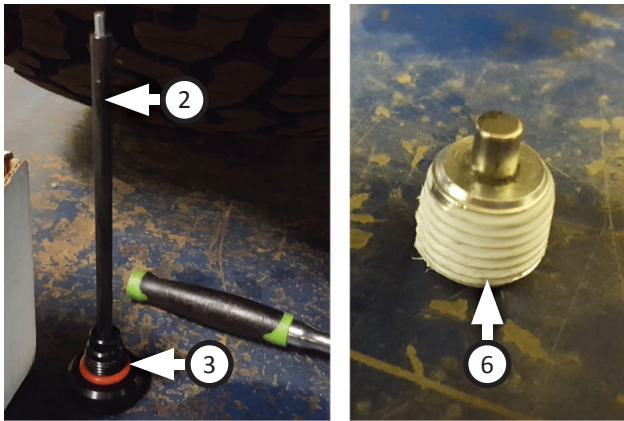

6. Install o-ring (3) onto dipstick (2). Wrap drain plug (6) with PTFE tape (about 2 wraps).

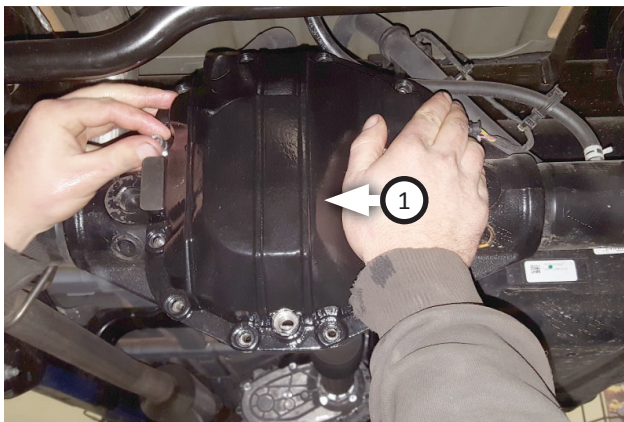

7. Place factory gasket (removed step 4) onto rear differential cover (1). Secure them to rear differential using screws (x2) on both sides as shown.

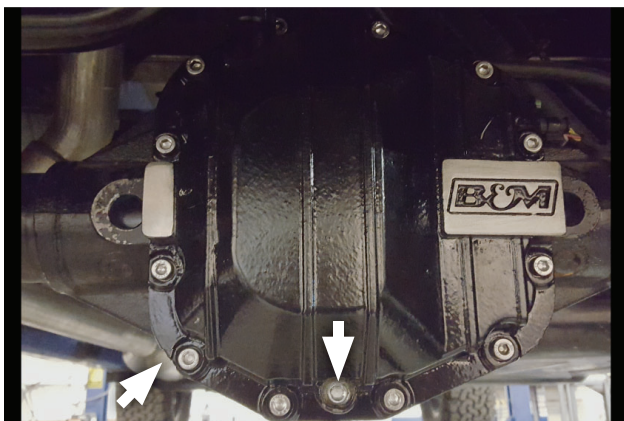

8. Install factory plug (removed step 3) and remaining screws (x10) to secure front differential cover then install drain plug.

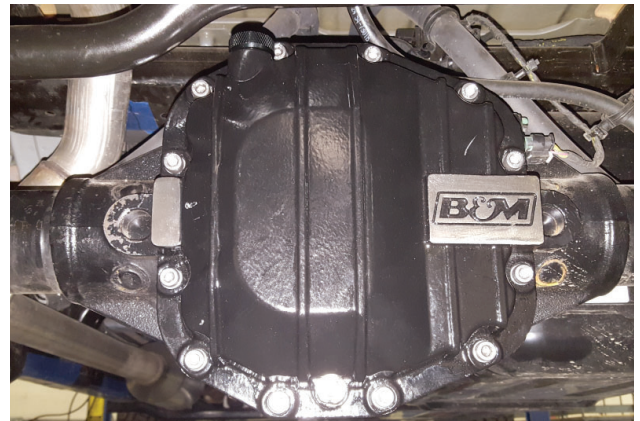

NOTE: Add differential fluid slowly using transfer pump.

9. Refill differential fluid (specified by vehicle's manufacturer) to fill line. Check fluid level using dipstick. Once it has been filled, re-install dipstick.



Congratulations, the installation of your B&M Rear Differential Cover is now complete!

NOTE: B&M Racing maintain a highly trained technical service department to answer your technical questions, provide additional product information and offer various recommendations.

