

3M WORKTUNES™ WIRELESS
featuring Bluetooth® wireless technology



3M WORKTUNES™ WIRELESS

3M™ Worktunes™ Wireless Hearing Protector with Bluetooth® wireless technology provides entertainment and hearing protection in one easy to use and comfortable earmuff. Seamlessly streams music from mobile phones, tablets, iPods® or any other Bluetooth® enabled device.

CONTENTS

Basic Operations	4
Instructions	8
Quickstart Guide	12
User Information	14
Cautions	15
Noise Reduction Rating	16

Basic Operations

Installing Batteries:

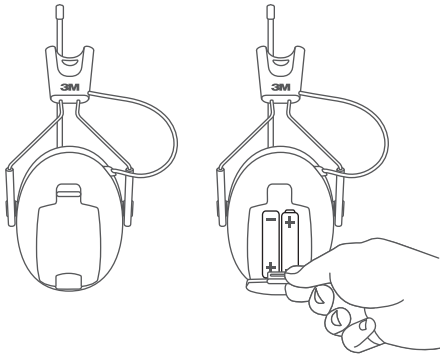

Install two 1.5V AA batteries as shown. Close battery door until it clicks.

Power and Volume:



Press and hold the On/Off/Volume button for 2 seconds to power headset. Turn On/Off/Volume knob clockwise to control volume.

Fitting Headset:

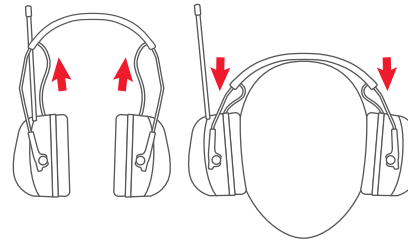

Fully extend sliders and place cups over ears so that the microphones are facing forward. Then, tighten headband using sliders.

Headband Padding:

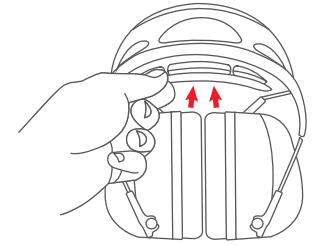

For improved comfort, insert the Comfort Pad into the headband holes from below with the textured cushion facing down. To remove the padding, simply hold the headband securely, and push down on the headband padding.

Basic Operations

Low battery warning:

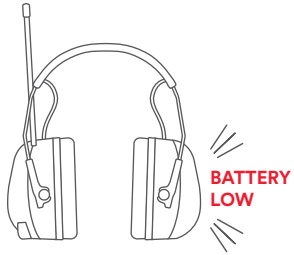

Headset will give a “battery low” warning every one minute when battery voltage is low. Additional warnings will occur as hearing protector powers down. Replace batteries at this time.

Auto shut-off:



After 2 hours of non-activity, a 10-second countdown will begin before hearing protector automatically powers down. To reset auto shut-off, simply adjust volume knob.

After auto shut-off, turn On/Off/Volume knob to “off” position for 2 seconds, then back to “on.”

Safe volume control:

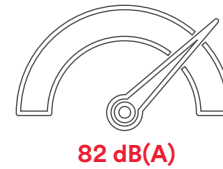

The safe volume control technology allows for increased music volume while protecting your hearing, by controlling sound levels over an 8-hour work day. Higher sound exposure is allowed for a period of time, and then gradually reduced if necessary below the long term average of 82 dB(A) for extended use.

Music equalizer:

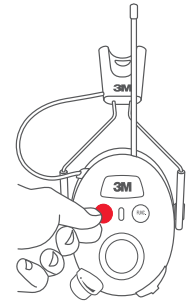

Press and Hold the source button. The device will cycle through the three equalizer Modes (Pop,Rock & Flat), then release the button when you reach the desired Mode.

Download complete WorkTunes™ Wireless Hearing Protector User Manual online at 3MSafety.com.

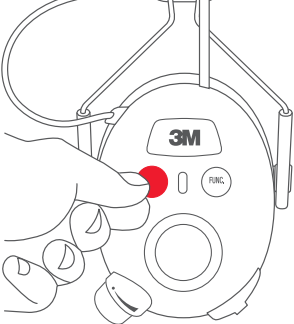

Press the source button to activate AM/FM Radio

AM/FM Radio allows you to scan through all radio frequencies, save your favorite stations, and recall your saved stations.

AM/FM Mode

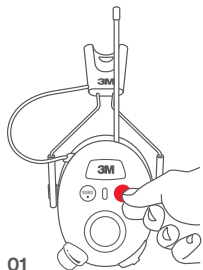

01

01 Select Mode



Press the Function button to select **Frequency Mode**. This mode will allow you to scan through all stations.

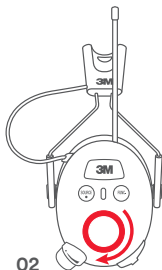

02

02 Tune or Seek



Turn the tuning knob clockwise to scroll through all stations. Press the tuning knob in to seek stations.

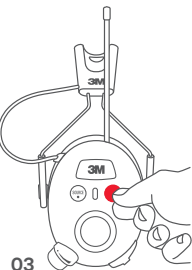
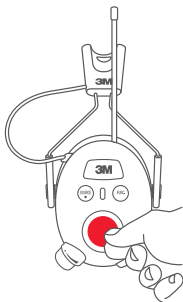

03

03 Save Stations



Press and hold the Function button for 2 seconds to save a station.

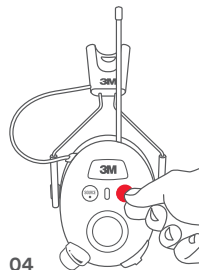

04

04 Select Mode



Press the Function button to select **Recall Mode**. This mode will allow you to scan through all your saved stations.

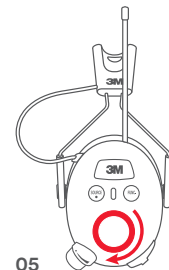

05

05 Recall Stations



Turn the tuning knob clockwise to scan through your saved stations.

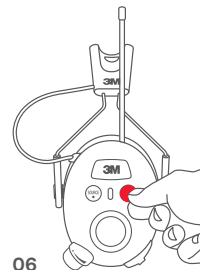

06

06 Delete Stations



Press and hold the Function button for 2 seconds to delete a saved station.

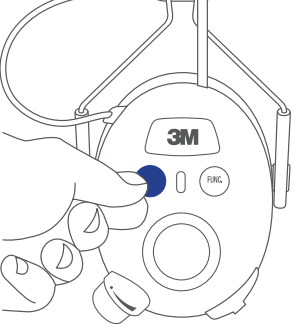

Press the source button to activate Bluetooth® Mode

Bluetooth® Mode allows you to connect earmuffs to your Bluetooth® Device.

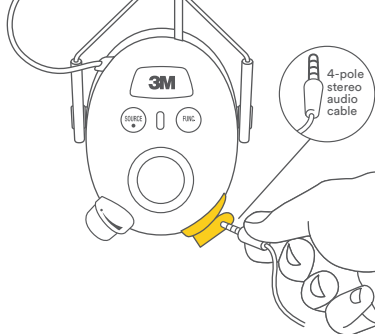

Connect the device to auto activate Input Mode

Audio Input Mode allows you to directly connect earmuffs to any device.

Note: You can also use the source button to activate Input Mode.

Bluetooth® Mode

Audio Input Mode

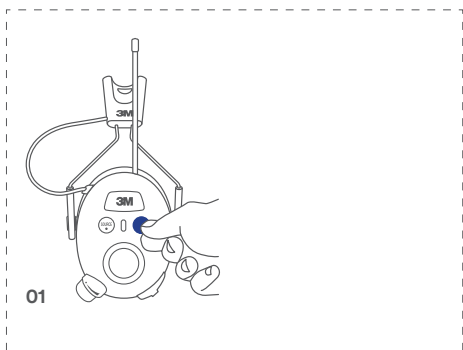

01

01 Pair Device

Press and hold the function button for 2 seconds to enter **Bluetooth® Pairing Mode**. On your device, connect to “Worktunes Wireless” using Bluetooth. You will hear “Bluetooth Connected” when your device is paired successfully.

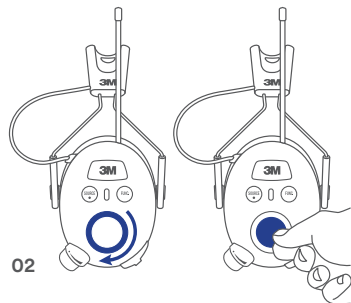

02

02 Fwd/Bck or Pause/Play

Turn the tuning knob to scroll forward or backward. Press the tuning knob in to pause/play.

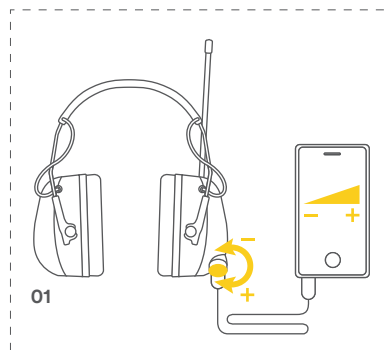

01

01 Connect Device

Connect the device using only the included 4-pole stereo audio cable. Turn on headset. Use headset to control ambient volume. Use device to control input.

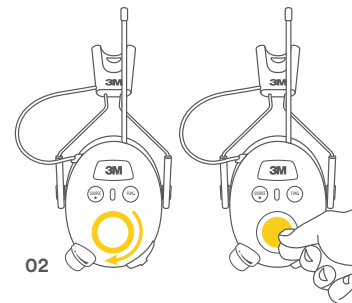

02

02 Fwd/Bck or Pause/Play

Turn the tuning knob to scroll forward or backward. Press the tuning knob button to pause/play.

Quickstart Guide

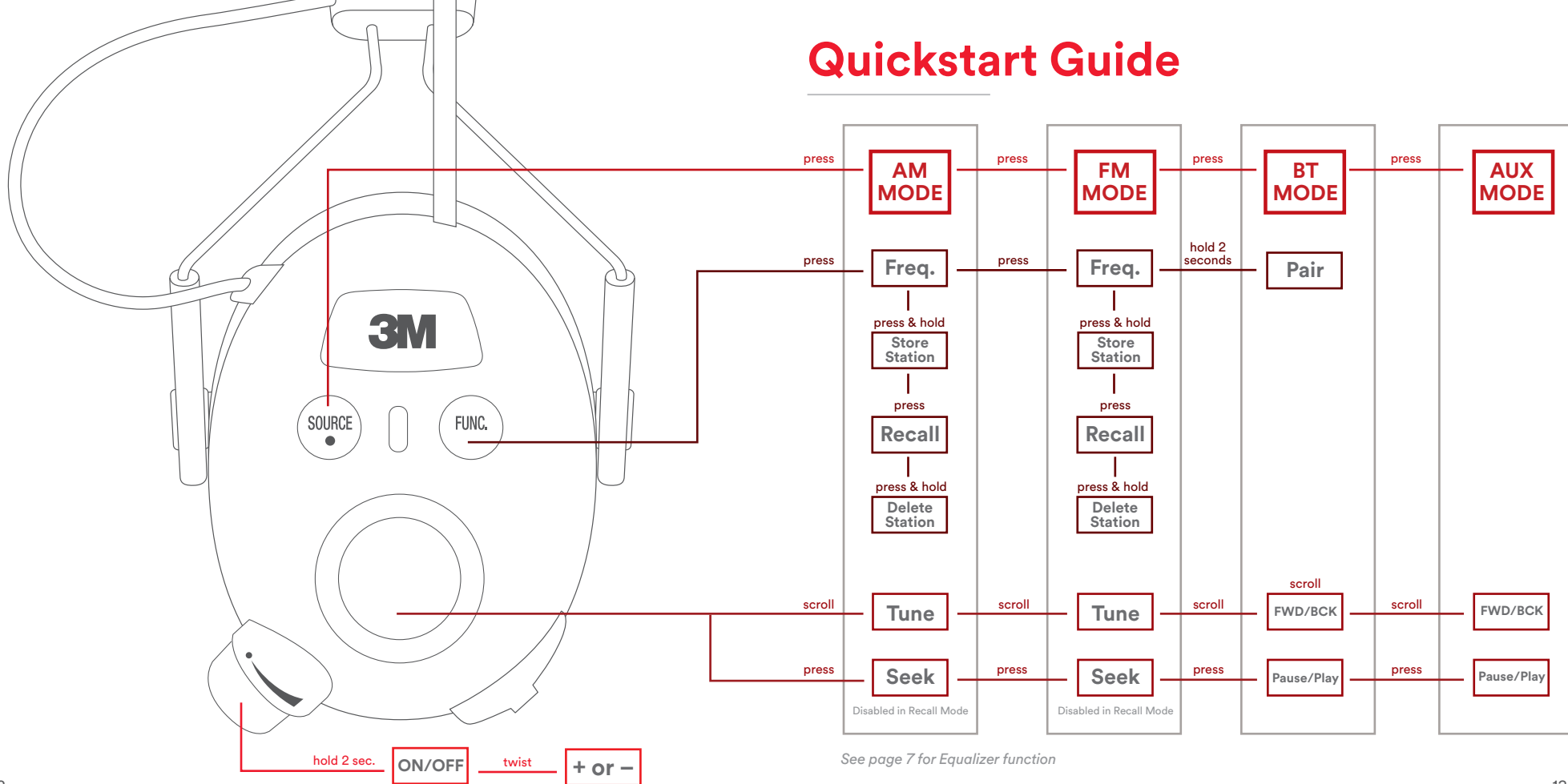

IMPORTANT USER INFORMATION



For best protection, ear cushion sealing rings should seal firmly against head. Anything that interferes with the seal — such as long hair (pull back to the extent possible), thick or poorly fitting eyeglass temples, pencils or caps — will lessen the protection.



Do not bend or reshape the headband, as this will cause a loose fit and sound leakage.



Earmuffs must be regularly inspected for cracks or worn parts and replaced as needed. Typical life for foam cushion sealing rings is six months.



Clean the exterior of the hearing protector regularly with soap and warm water. Do not immerse in water.



Do not store the hearing protector behind a windshield or at temperatures above 131°F (55°C).



Certain chemical substances may damage this product. Contact the manufacturer for more information.

⚠ CAUTION

TO REDUCE THE RISKS ASSOCIATED WITH HARMFUL NOISE OR CHEMICALS:

If instructions are not followed, bodily injury may result or protection may be severely affected.

When interference increases or the sound level becomes too weak, it is time to change the batteries.

Do not store with the batteries installed. A leaking battery may cause bodily injury or damage to the hearing protector.

These hearing protectors help reduce exposure to hazardous noise and other loud sounds. Misuse or failure to wear hearing protectors at all times when you are exposed to noise may result in hearing loss or injury.

If there is any drainage from your ear or if you have an ear infection, consult with your physician before wearing hearing protection. Failure to do so may result in hearing loss or injury.

For proper use, see user instructions or call 3M Technical Service toll free at 1-800-494-3552.

NOISE REDUCTION RATING (NRR)

The Environmental Protection Agency (EPA) has selected the Noise Reduction Rating (NRR) as the measure of a hearing protector's noise-reducing capabilities. 3M makes no warranties as to the suitability of the NRR as a measure of actual protection from any noise level since such protection depends on the sound level (loudness), how long you listen to the loud sound and how well you fit the earmuff over your ears. Although hearing protectors can be recommended for protection against harmful effects of impulse noise, the NRR is based on the attenuation of continuous noise and may not be an accurate indicator of the protection attainable against impulse noise such as gunfire.

The NRR for the Worktunes™ Wireless is 25 dB(A). Improper fit of this device will reduce its effectiveness in attenuating noise. Consult the enclosed instructions for proper fit.

The level of noise entering a person's ear when a hearing protector is worn as directed is closely approximated by the difference between the A-weighted environmental noise level and the NRR.

Attenuation (ANSI S3.19 – 1974)

Test frequencies (Hz)	125	250	500	1000	2000	3150	4000	6300	8000	NRR
Mean attenuation (dB)	17.2	16.7	25.9	31.7	33.0	39.8	43.1	43.7	41.8	22
Standard deviation (dB)	3.5	1.9	2.7	2.5	2.6	2.8	2.9	2.4	2.2	

NOISE REDUCTION RATING

EXAMPLE

1. The environmental noise level as measured at the ear is 92 decibels (dB(A)).
2. The NRR is 25 dB(A).
3. The level of noise entering the ear is approximately 67 dB(A).

⚠ CAUTION

For noise environments dominated by frequencies below 500 Hz, the C-weighted environmental noise level should be used. The NRR used in the above example was achieved under laboratory conditions.

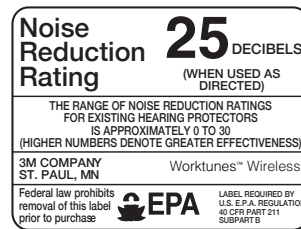

AUDIO INPUT LEVEL

The audio level in the hearing protector is dependent on the audio input level. To prevent harmful noise levels, the hearing protector audio level is limited to 82 dB(A) when connected to a Personal Music Player (PMP). If the hearing protector is connected to a PMP or other device with a very high output level, it is the user's responsibility to set the audio input level to a safe level. The maximum permitted audio input level for 8 hours of usage time, compressed speech and music is 188 mV.

WARRANTY

The Worktunes™ Wireless is warranted to be free of defects in material and workmanship for a period of one (1) year from the date of original purchase. 3M will, at its option, repair or replace without charge, except for transportation costs, parts that fail under normal use and service when operated and maintained in accordance with our instructions. This warranty does not cover damage caused by misuse, abuse or unauthorized modifications. Proof of purchase is required to verify eligibility.

LITHIUM ION BATTERY PACK (OPTIONAL)

INSTALLING BATTERY:

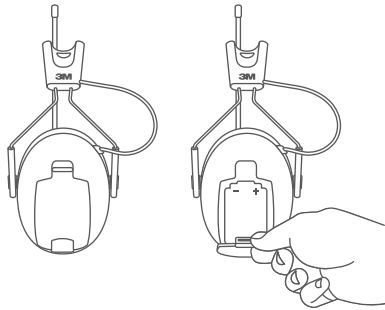

Install one optional Lithium-Ion battery pack as shown. Close battery door until it clicks.

CHARGING BATTERY PACK:

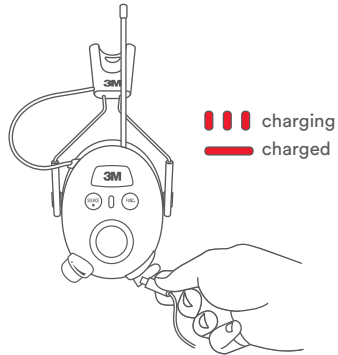

Insert the micro-USB connector cable into the micro-USB jack. Connect the other end of the cable to a USB power source to begin charging.

The LED will blink when the battery pack is charging, and turn solid when charging is complete.

SPANISH

INSTALLING BATTERY:

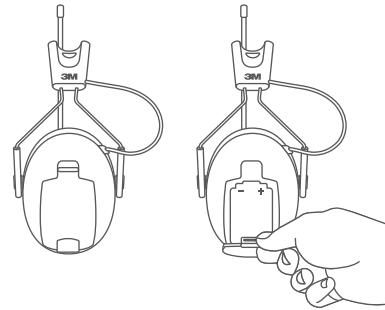

Install one optional Lithium-Ion battery pack as shown. Close battery door until it clicks.

CHARGING BATTERY PACK:

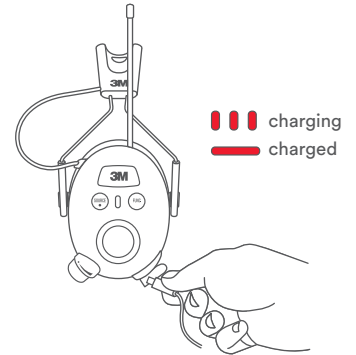

Insert the micro-USB connector cable into the micro-USB jack. Connect the other end of the cable to a USB power source to begin charging.

The LED will blink when the battery pack is charging, and turn solid when charging is complete.