

Tru Trac™

Big Block Chevrolet
Installation Manual
For Systems Without A/C
#14225 / #14125

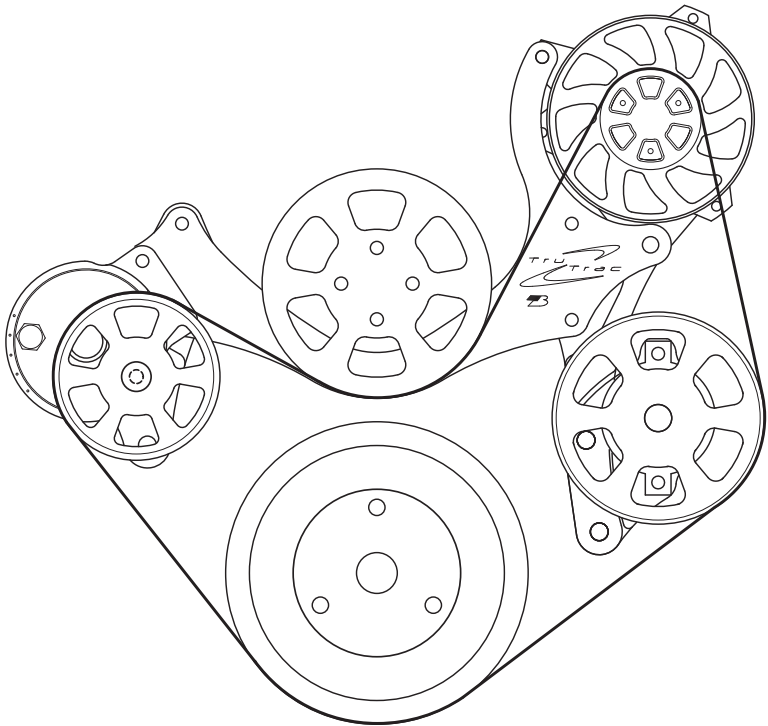

Billet Specialties, Inc.
500 Shawmut Ave.
La Grange, IL 60526
Tech Line (708) 588-0505
Fax (708) 588-7181

PLEASE READ ALL INSTRUCTIONS BEFORE INSTALLING ANY COMPONENTS OF THE TRU TRAC SERPENTINE SYSTEM

Required Tools & Materials

- | | | |
|---------------------------------------------------------|----------------------------------------------------|--------------------------------------|
| <input type="checkbox"/> Anti-seize Compound | <input type="checkbox"/> 9/16" Combo Wrench | <input type="checkbox"/> 3/16" Allen |
| <input type="checkbox"/> Loc-Tite® Thread Locker | <input type="checkbox"/> 11/16" Combo Wrench | <input type="checkbox"/> 5/16" Allen |
| <input type="checkbox"/> RTV Silicone | <input type="checkbox"/> 3/4" Combo Wrench | <input type="checkbox"/> 1/4" Allen |
| <input type="checkbox"/> Gasket Scraper | <input type="checkbox"/> Socket Wrench & Extension | <input type="checkbox"/> 3/8" Allen |
| <input type="checkbox"/> Scotch-Brite® Pad | <input type="checkbox"/> 10mm 12pt. socket | <input type="checkbox"/> 4mm Allen |
| <input type="checkbox"/> 3/8-16 Thread Chaser* & Holder | <input type="checkbox"/> 12mm 12pt. socket | <input type="checkbox"/> 5mm Allen |
| <input type="checkbox"/> 7/16-14 Thread Chaser* | <input type="checkbox"/> 3/8" 12pt. socket | <input type="checkbox"/> 6mm Allen |

*Thread chasers are available at your local parts store and are different from a thread cutting tap.

TECH TIP:

Billet Specialties recommends the use of Anti-Seize on all fasteners to prevent thread lock-up.

Skin Board #1 - Packaged with Power Steering Pump



5/16-24 x 3" Socket Head Cap Screw
Power Steering Pump

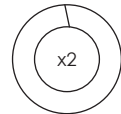

5/16" Lock Washer

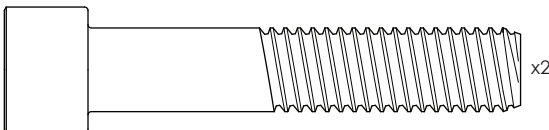

7/16-14 x 2-1/4" Socket Head Cap Screw
Power Steering Bracket

Prepping The Block

- Disconnect the battery.
- Remove the existing alternator, air conditioning compressor and associated brackets
- Remove pulleys and water pump
- Remove all traces of gasket and sealer with a gasket scraper and Scotch Brite® pad.
- Clean threads in block by chasing the water pump mounting threads with a 3/8-16 thread chaser and the threads on the two lower bosses on either side of the balancer with a 7/16-14 thread chaser.

Skin Board #2 - Packaged with Water Pump

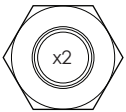

Zinc Coated
Hex Nuts
(Discard After Use)

Short Stand-off
2-3/8" x1



Long Stand-off
3" x3



Tensioner Stand-off
With Boss 3" x1

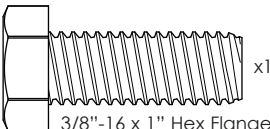

3/8"-16 x 1" Hex Flange Bolt x1



3/8-16 x 3" Threaded Stud x4

Skin Board #3 - Packaged In Main Box

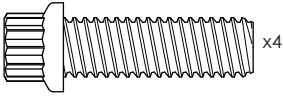

8mm-1.25 x 25mm 12pt. Cap Screw
Bridge Bracket

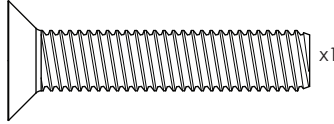

8mm-1.25 x 40mm Flat Socket
Cap Screw - Bridge Bracket

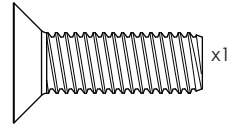

8mm-1.25 x 25mm Flat Socket
Cap Screw - Bridge Bracket

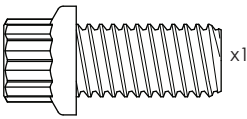

3/8-16 x 3/4" 12pt. Cap Screw
Tensioner Pulley

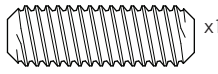

8mm-1.25 x 25mm Socket Set Cup Point
Tensioner Assembly

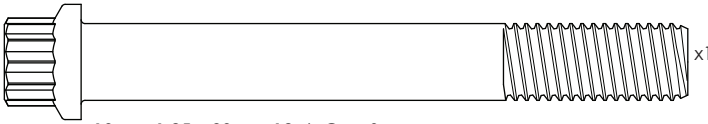

10mm-1.25 x 80mm 12pt. Cap Screw
Alternator

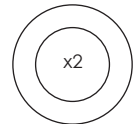

10mm x .5mm
Shim Washer

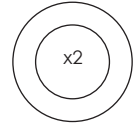

10mm x 1mm
Shim Washer

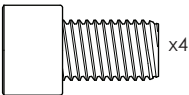

5/16-24 x 1/2" Socket Head Cap Screw
Water Pump Pulley

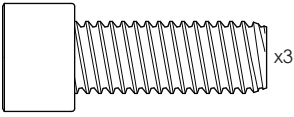

3/8-16 x 1" Socket Head Cap Screw
Crank Pulley

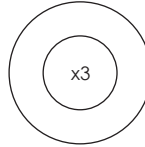

3/8" Belleville Washer

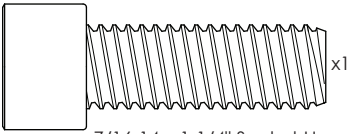

7/16-14 x 1-1/4" Socket Head Cap Screw
Tensioner Support Bracket

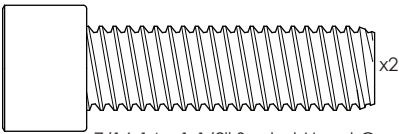

7/16-14 x 1-1/2" Socket Head Cap Screw
Alternator Bracket (Without Power Steering)



x4
O-Ring Pack

Other Hardware / Gaskets

Continental Elite Poly-V Serpentine Belt: 56"

#4060560 (with power steering)

Continental Elite Poly-V Serpentine Belt: 53-3/4"

#4060537 (without power steering)

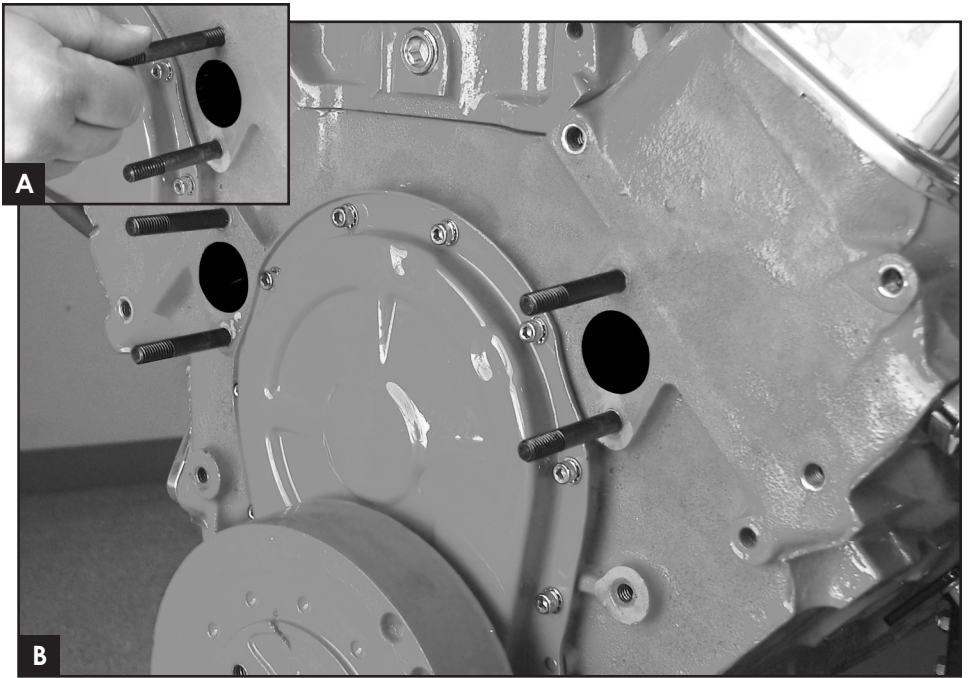

Figure 1: Installing Mounting Studs

Apply RTV silicone to one end of the four 3/8-16 x 3" threaded studs.

A] Use the two included 3/8-16 nuts (zinc plated) tightened against each other to act as a drive nut to ease installation (see illustration below).

B] Seat studs firmly into block.

EXAMPLE

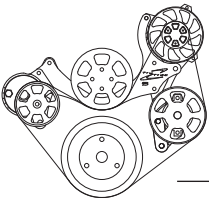

TRU
Trac

BilletSpecialties

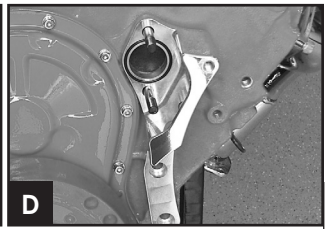
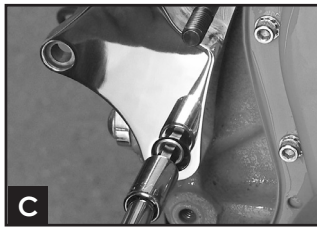
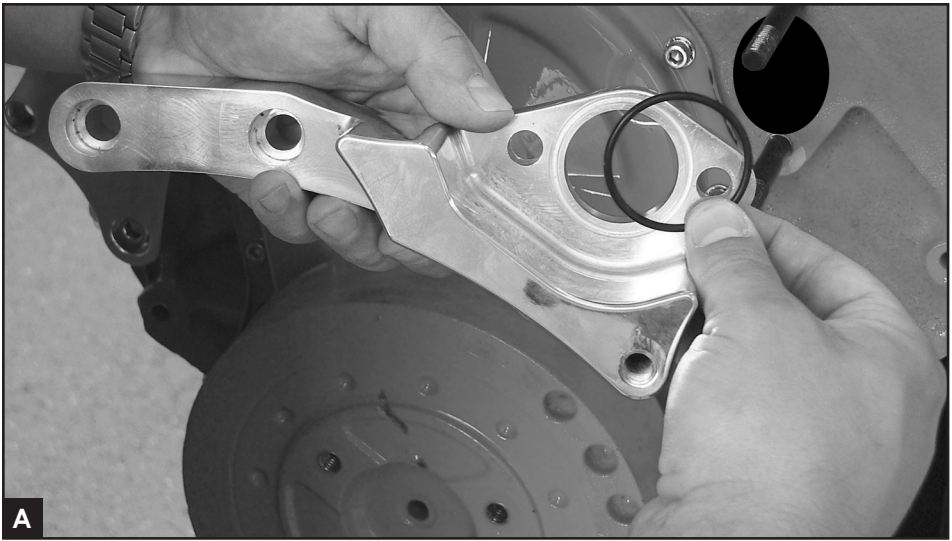

Figure 2: Install Tensioner Support & Alternator Bracket

A] The tensioner support and alternator mounting bracket incorporate o-rings on both sides for sealing.

B] Slide the tensioner support bracket onto the water pump studs on passenger side of block and seat against block.*

C] Apply anti-seize to the 7/16-14 x 1-1/4" socket head cap screw and thread the bolt through the tensioner support bracket and into the block.

D] Slide the alternator bracket onto the water pump studs on driver side of block and seat against the block.

* **Gen VI Blocks without mechanical fuel pump provision:** Place 3/8-16 x 1" hex head flange bolt through tensioner support bracket at this time.



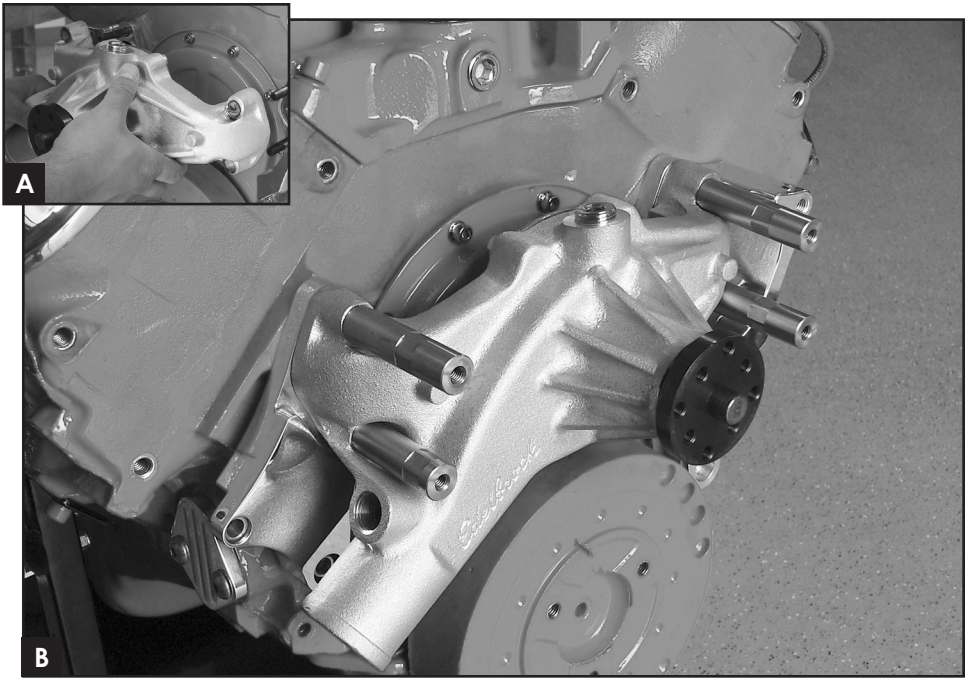

Figure 3: Install Water Pump & Stand-offs

Apply anti-seize to all exposed threads on the block mounting studs.

A] Slide the water pump over the four mounting studs.

B] Install the four stand-offs that hold the water pump in place.

- The short stand-off attaches to the passenger side lower stud.
- The long stand-offs without a boss install on the three remaining studs.
- Tighten all firmly

Now would be a good time to install the heater hose fitting onto the water pump.

Short Stand-off x1



Long Stand-off x3

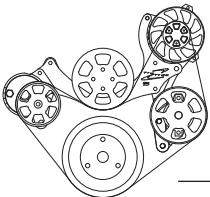

TRU
Trac

Billet Specialties

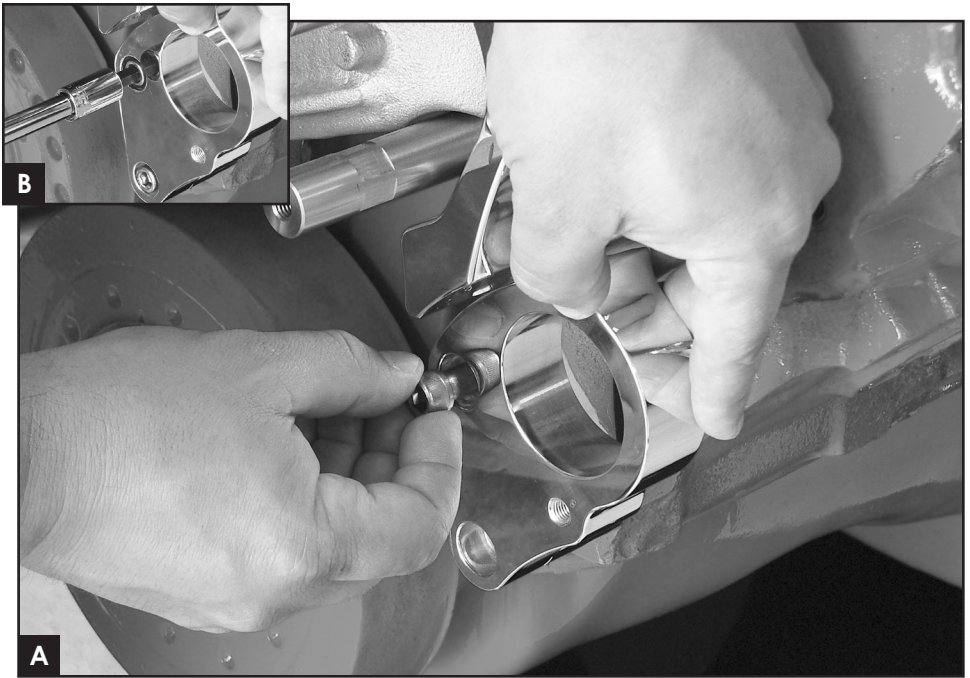

Figure 4: Install Power Steering Bracket

Without Power Steering: Apply anti-seize to the two 7/16-14 x 1-1/2" socket head cap screws and install them through the lower end of the alternator bracket into the block.

With Power Steering: Apply anti-seize to the threads of the two 7/16-14 x 2-1/4" socket head cap screws.

A] Place power steering bracket onto the lower end of the alternator bracket.

B] Thread the two screws through both brackets and into the block and tighten firmly.



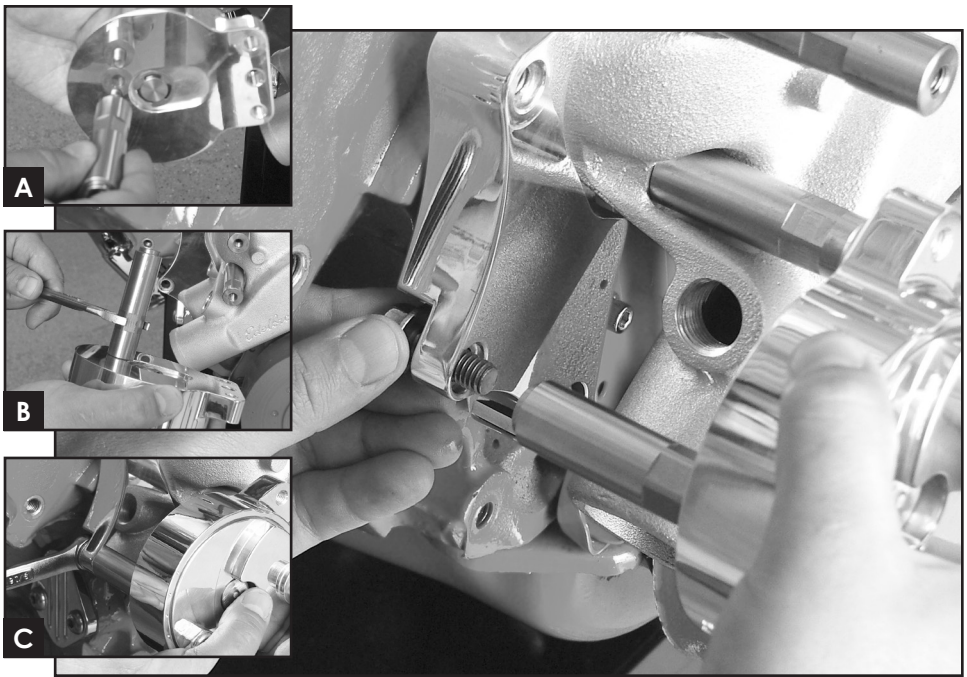

Figure 5: Install the Tensioner

A] Apply anti-seize to the 8mm-1.25 x 25mm socket set stud and thread into the remaining long stand-off with boss, tighten with 4mm Allen key (stud installs in stand-off opposite of boss).

B] Attach the long stand-off with boss to the backside of tensioner.

C] Attach assembly to lower tensioner support bracket ear by applying anti-seize to the 3/8-16 x 1" hex head flange bolt and threading it through the lower ear of the tensioner support bracket into the stand-off boss.

Do not completely tighten at this time.

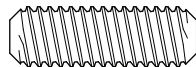

8mm-1.25 x 25mm
Socket Set Cup Point

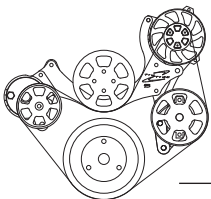

TRU
Trac

BilletSpecialties

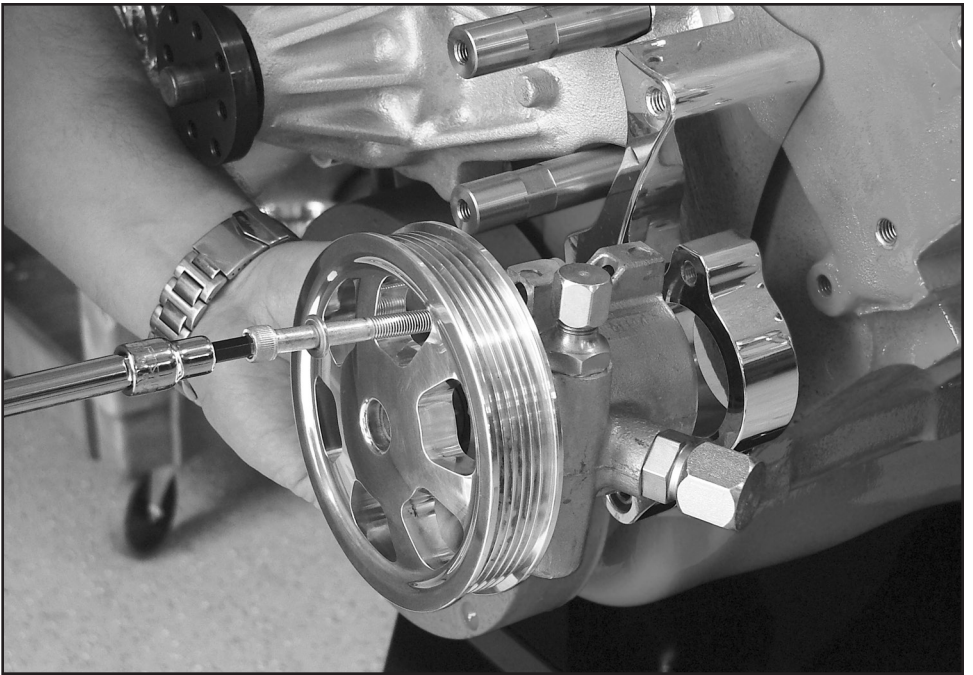

Figure 6: Install Power Steering Pump with Pulley

Apply anti-seize to the threads of the two 5/16-24 x 3" socket head cap screws - place pump to bracket and align.

Install lock washers to screws and thread through the power steering pump into the bracket and tighten firmly.



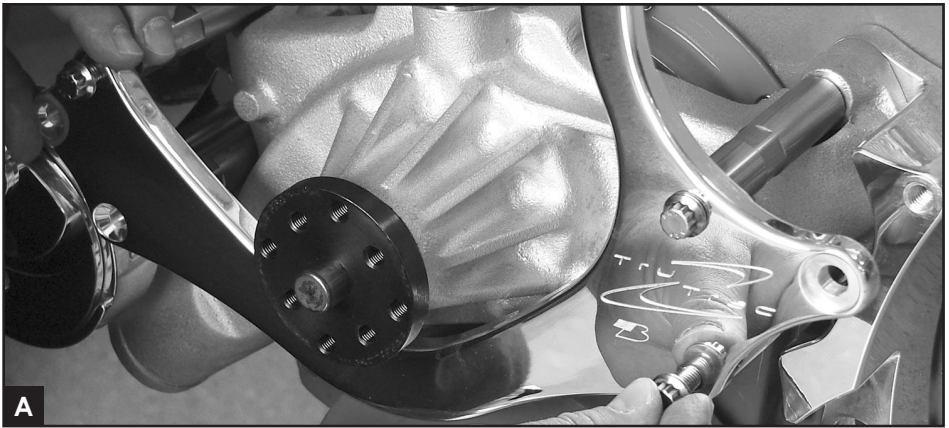
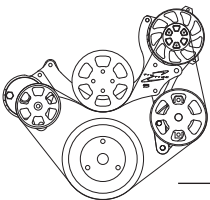

Figure 7: Attaching Bridge Bracket

A] Install the bridge bracket to the three water pump stand-offs by applying anti-seize to and using three 8mm-1.25 x 25mm 12 pt. cap screws.

B] The bridge bracket also attaches to the tensioner using a 8mm-1.25 x 40mm flat socket cap screw (installs in lower boss through bracket and tensioner into stand-off) and a 8mm-1.25 x 25mm flat socket cap screw (installs through bracket into tensioner).



TRU
Trac

Billet Specialties

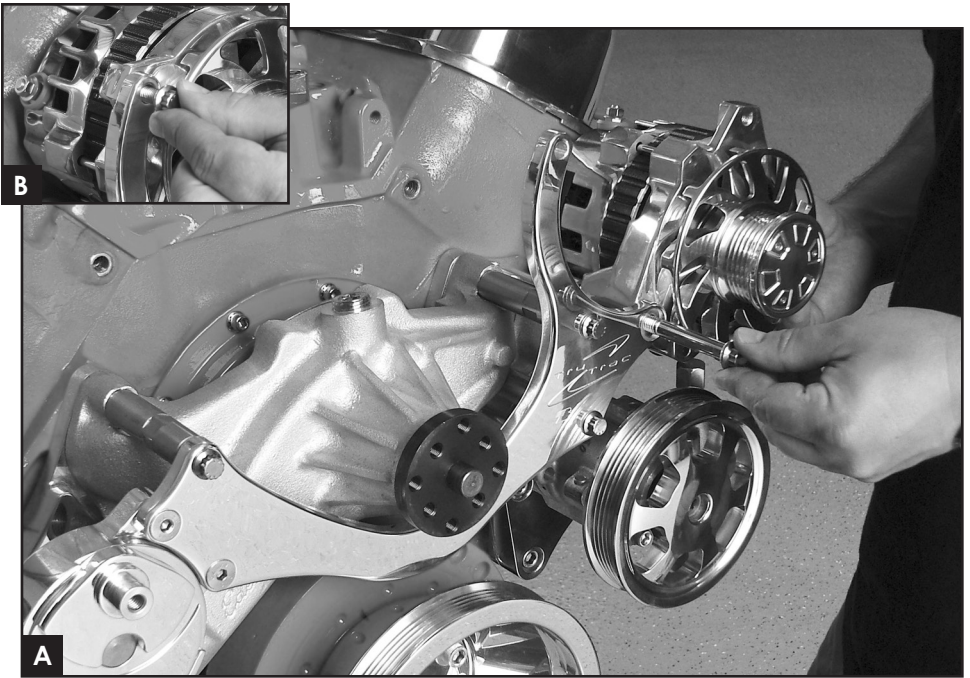

Figure 8: Attaching Alternator

A] Place the alternator behind the bridge bracket apply anti-seize to threads and install the 10mm-1.5 x 80mm 12 pt. cap screw in the lower alternator mounting hole.

Note: The alternator mounting boss may vary in width due to the polishing process. 10mm shim washers are provided to shim alternator to bridge bracket (washers may not be needed).

B] Complete alternator installation using one 8mm-1.25 x 25mm 12 pt. cap screw by applying anti-seize to threads and threading through the bridge bracket into the top ear of the alternator.

At this point we are ready to tighten the hex flange bolt on tensioner bracket. Once this is tightened you may then tighten all bolts on the bridge bracket assembly.

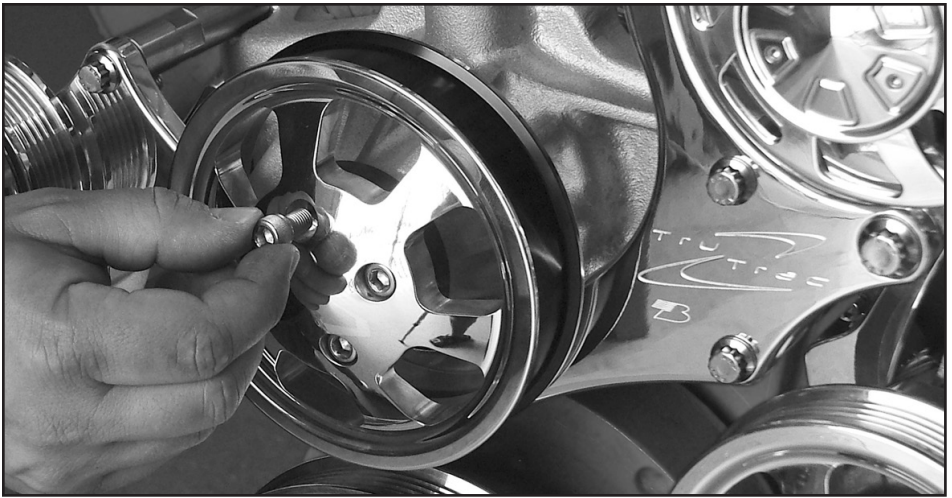

Figure 9: Install Water Pump Pulley onto Pump

Apply anti-seize to four 5/16-24 x 1/2" socket head cap screws and install the water pump pulley onto the water pump. Tighten firmly.

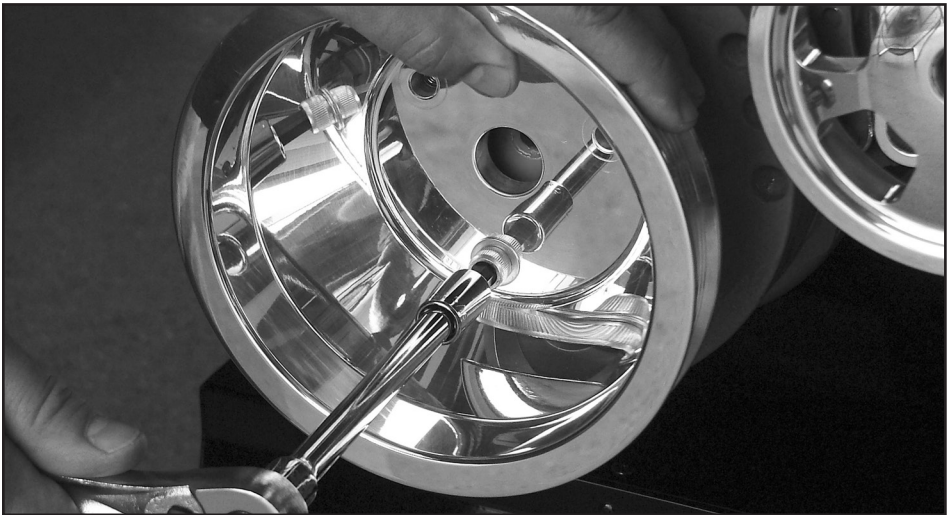
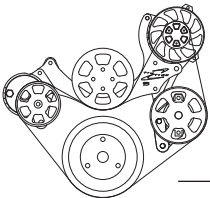

Figure 10: Install Crankshaft Pulley

Install the crankshaft pulley to the harmonic balancer by applying Loc-Tite to three 3/8-16 x 1" socket head cap screws with three 3/8" Belleville washers (cup towards engine). Torque to 35 ft. lbs.



TRU
Trac

BilletSpecialties

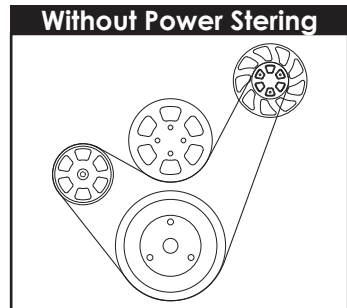
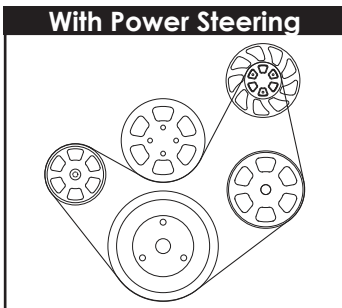

Figure 11: Install Serpentine Belt & Tensioner Pulley

- Route belt as shown below minus tensioner pulley.
- Place a 5/8" box end wrench on tensioner, align belt onto groove of tensioner pulley.

A] Pull up on wrench until tensioner pulley hole lines up with boss on tensioner, slide pulley onto boss and slowly lower wrench to apply tension to serpentine belt.

B] Apply anti-seize to the threads of the 3/8-16 x 3/4" ARP 12pt. cap screw and thread it through the aluminum washer into tensioner boss and tighten firmly (46 ft/lbs.).



#14225 / #14125



Billet Specialties, Inc.
500 Shawmut Avenue
La Grange, Illinois 60526
Tech Line 708.588.0505
Fax 708.588.7181
www.billetspecialties.com

