

Installation Manual

Banks SpeedBrake

For use with Palm® Tungsten™ E2

**2004-2005 Chevy/GMC 6.6L (LLY)
Turbo-Diesel Pickup**

THIS MANUAL IS FOR USE WITH KITS 55419 & 55421

Gale Banks Engineering
546 Duggan Avenue • Azusa, CA 91702
(626) 969-9600 • Fax (626) 334-1743

Product Information & Sales: (888) 635-4565
Customer Support: (888) 839-5600
Installation Support: (888) 839-2700

bankspower.com



Do not use this product until you have carefully read the following agreement.

This sets forth the terms and conditions for the use of this product. The installation of this product indicates that the BUYER has read and understands this agreement and accepts its terms and conditions.

Disclaimer of Liability

Gale Banks Engineering Inc., and its distributors, employees, and dealers (hereafter "**SELLER**") shall in no way be responsible for the product's proper use and service. The BUYER hereby waives all liability claims.

The **BUYER** acknowledges that he/she is not relying on the **SELLER's** skill or judgement to select or furnish goods suitable for any particular purpose and that there are no liabilities which extended beyond the description on the face hereof and the **BUYER** hereby waives all remedies or liabilities, expressed or implied, arising by law or otherwise, (including without any obligations of the **SELLER** with respect to fitness, merchantability, and consequential damages) whether or not occasioned by the **SELLER's** negligence.

The **BUYER** is responsible to fully understand the capability and limitations of his/her vehicle according to manufacturer specifications and agrees to hold the **SELLER** harmless from any damage resulting from the failure to adhere to such specifications. The **SELLER** disclaims any warranty and expressly disclaims any liability for personal injury or damages. The **BUYER** acknowledges and agrees that the disclaimer of any liability for personal injury is a material term for this agreement and the **BUYER** agrees to indemnify the **SELLER** and to hold the **SELLER** harmless from any claim related to the item of the equipment purchased. Under no circumstances will the **SELLER** be liable for any damages or expenses by reason of the use or sale of any such equipment. The **BUYER** is responsible to obey all applicable federal, state, and local laws, statutes, and ordinances when operating his/her vehicle, and the **BUYER** agrees to hold the **SELLER** harmless from any violation thereof. The **SELLER** assumes no liability regarding the improper installation or misapplication of its products. It is the installer's responsibility to check for proper installation and if in doubt, contact the manufacturer. The **BUYER** is solely responsible for all warranty issues from the automotive manufacturer.

Limitation of Warranty

Gale Banks Engineering Inc. (hereafter “**SELLER**”), gives Limited Warranty as to description, quality, merchantability, fitness for any particular purpose, productiveness, or any other matter of **SELLER’s** product sold herewith. The **SELLER** shall be in no way responsible for the product’s open use and service and the **BUYER** hereby waives all rights except those expressly written herein. This Warranty shall not be extended or varied except by written instrument signed by **SELLER** and **BUYER**.

Please see enclosed warranty information card, or go to www.bankspower.com/warranty, for warranty information regarding your product. Parts or devices outside the products kit, such as the Palm® Tungsten™ E2, are not covered under Gale Banks Engineering warranty. The warranty for the Palm Tungsten E2 is determined by the manufacturer’s warranty terms and conditions, and limited to a period of 90 days from purchase. All products that are in question of Warranty must be returned shipping prepaid to the **SELLER** and must be accompanied by a dated proof of purchase receipt. All Warranty claims are subject to approval by Gale Banks Engineering Inc.

WARNING: The PDA may be susceptible to damage as a result of extended exposure to sunlight, heat or extreme cold. It is highly recommended that the PDA be removed from its mounting location if the vehicle will be subjected to high concentrations of sunlight, heat or cold for an extended period of time. Gale Banks Engineering is not responsible for damage to PDAs resulting from exposure conditions.

Under no circumstance shall the **SELLER** be liable for any labor charged or travel time incurred in diagnosis for defects, removal, or reinstallation of this product, or any other contingent expense.

Under no circumstances will the **SELLER** be liable for any damage or expenses incurred by reason of the use or sale of any such equipment.

In the event that the buyer does not agree with this agreement:

The buyer may promptly return this product, in a new and unused condition, with a dated proof-of-purchase, to the place-of-purchase within thirty (30) days from date-of-purchase for a full refund, less shipping and/or restocking fee.

The installation of this product indicates that the buyer has read and understands this agreement and accepts its terms and conditions.

Table of Contents

General Installation	4
Practices	
Section 1	5
Installation of Banks SpeedBrake Wire Harness	
Section 2	11
Mounting The Docking Station and Connecting The Banks PowerPDA	
Section 3	15
Banks SpeedBrake PowerPDA Software & Installation	
Section 4	18
Placement of the Banks Power Decal	

General Installation Practices

Dear Customer,

Your new Banks SpeedBrake is a uniquely designed braking system with electronic controls, designed to achieve the optimum level of braking from your vehicle's engine.

If you have any questions concerning the installation of your Banks SpeedBrake System, please call our Technical Service Hotline at (888) 839-2700 between 7:00am and 5:00pm (PST). If you have any questions relating to shipping or billing, please contact our Customer Service Department at (888) 839-5600.

Thank you.

- 1.** Before starting work, familiarize yourself with the installation procedure by reading all of the instructions.
- 2.** The exploded views provide only general guidance. Refer to each step and section diagram in this manual for proper instruction.
- 3.** Throughout this manual, the left side of the vehicle refers to the driver side, and the right side to the passenger side.
- 4.** Disconnect the negative (ground) cable from the battery (or batteries, if there are two) before beginning work.
- 5.** Route and tie wires and hoses a minimum of 6" away from exhaust heat, moving parts and sharp edges. Clearance of 8" or more is recommended where possible.
- 6.** When raising the vehicle, support it on properly weight-rated safety stands, ramps or a commercial hoist.

Follow the manufacturer's safety precautions. Take care to balance the vehicle to prevent it from slipping or falling. When using ramps, be sure the front wheels are centered squarely on the topsides. When raising the front of the vehicle, put the transmission in park (automatic) or reverse (manual), set the parking brake, and block the rear wheels. When raising the back of the vehicle, be sure the vehicle is on level ground and the front wheels are blocked securely.

CAUTION: Do not use floor jacks to support the vehicle while working under it. Do not raise the vehicle onto concrete blocks, masonry or any other item not intended specifically for this use.

7. During installation, keep the work area clean. Do not allow anything to be dropped into intake, exhaust, or lubrication system components while performing the installation, as foreign objects will cause immediate engine damage upon start-up.

8. Save this Installation Manual as a reference for system maintenance and service.

TOOLS REQUIRED:

- 1/2" and 3/8" drive ratchets with inch and metric sockets and 1/2" and 3/8" drive extension
- Inch and metric combination or open-end wrenches
- Standard & Phillips screwdriver
- Clean shop towels or rags
- Pliers
- Needle nose pliers
- Utility knife
- Inch-pound and foot-pound torque ratchets

Section 1

INSTALLATION OF BANKS SPEEDBRAKE WIRE HARNESS

Figure 1 Banks SpeedBrake and supplied wiring harness

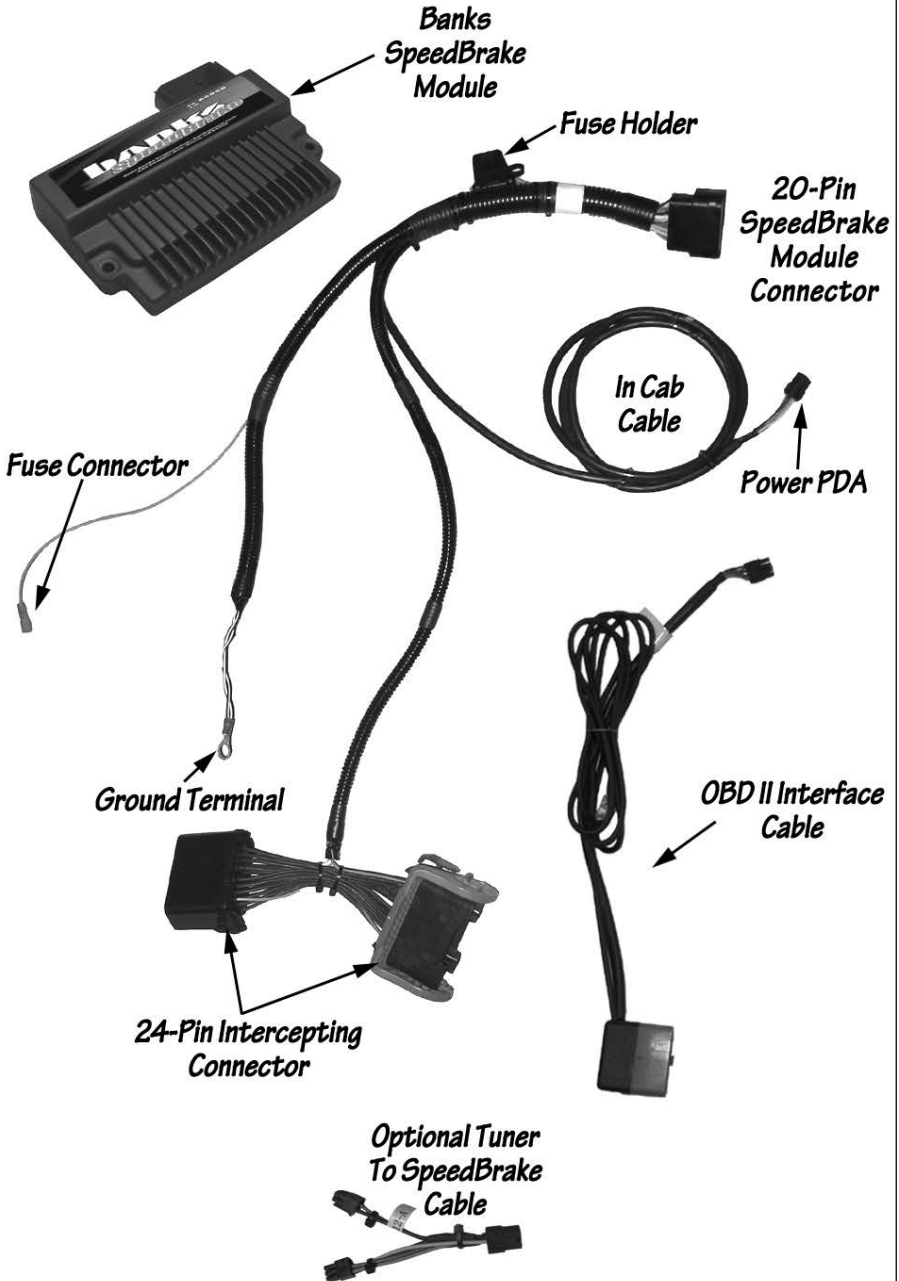

1. Before beginning the SpeedBrake installation, locate The Palm Tungsten E2 Power PDA in your kit. It will need to be charged for a minimum of one hour before the unit will function. Charge the unit with the supplied AC-outlet wall charger. The unit will be fully charged in one to two hours.

2. Disconnect the negative (ground) cable from the battery (or batteries, if there are two) before beginning work. Secure the cables so that they do not come in contact with the battery posts during the installation.

3. Locate the Banks SpeedBrake wire harness in your kit. Start By placing the wire harness near the under hood fuse box.

4. Install the ground ring terminal on the SpeedBrake wire harness onto the bolt on the fire wall. See **Figure 1**.

5. Remove the fuse box cover to access the fuses on the electrical center and set aside.

6. Locate mini-fuse for the Body Control Module (TBC IGN1) and remove it. See **Figure 2**.

7. Install the mini-blade fuse tap onto the removed mini fuse as shown in **Figure 3**. Re-install the mini fuse with the attached blade tap into the fuse box.

*NOTE: install the fuse tap in the Body Control Module (TBC IGN1) spot closest to the firewall. This is the "hot" side of the circuit. See **Figure 2**.*

8. Locate the fuse connector wire on the SpeedBrake wiring harness and connect it to the mini-blade fuse tap.

9. Replace the fuse box cover and make sure not to pinch the fuse connector wire.

10. Locate the black wire harness locking connectors between the brake fluid reservoir and the air conditioning compressor. Lift the gray connector locks and disconnect the 24-pin connector pair. See **Figure 1**.

Figure 1 Grounding location & 24-Pin Intercepting Connectors

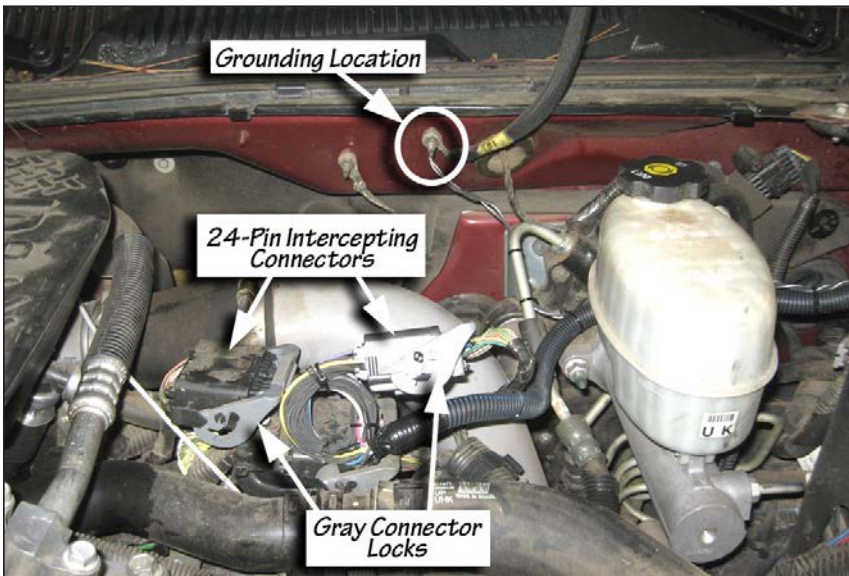

Figure 2 Electrical Center Fuse Tap Location

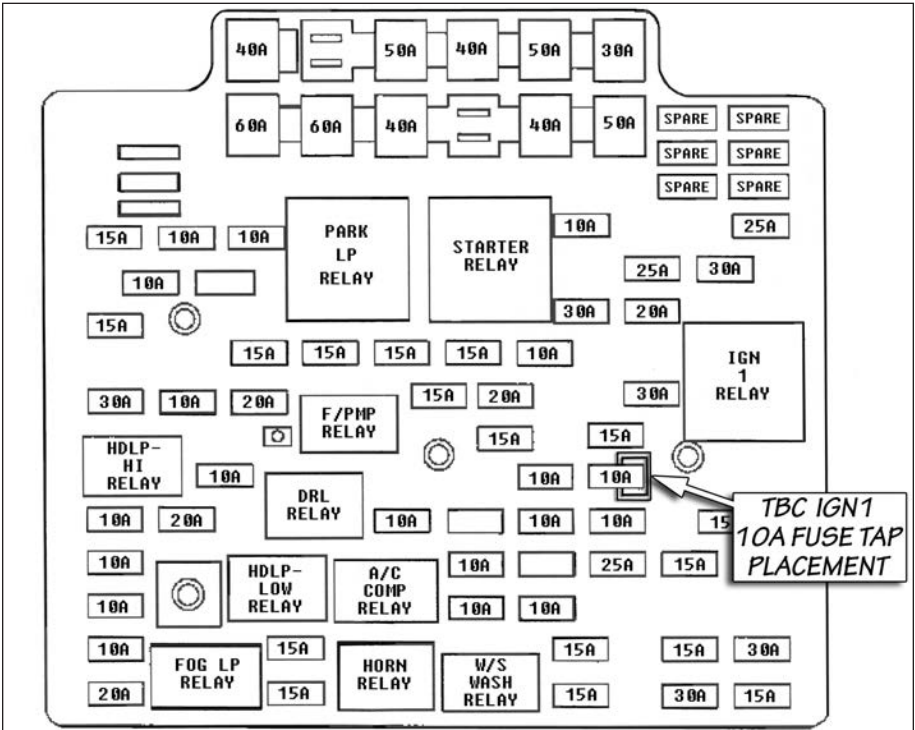
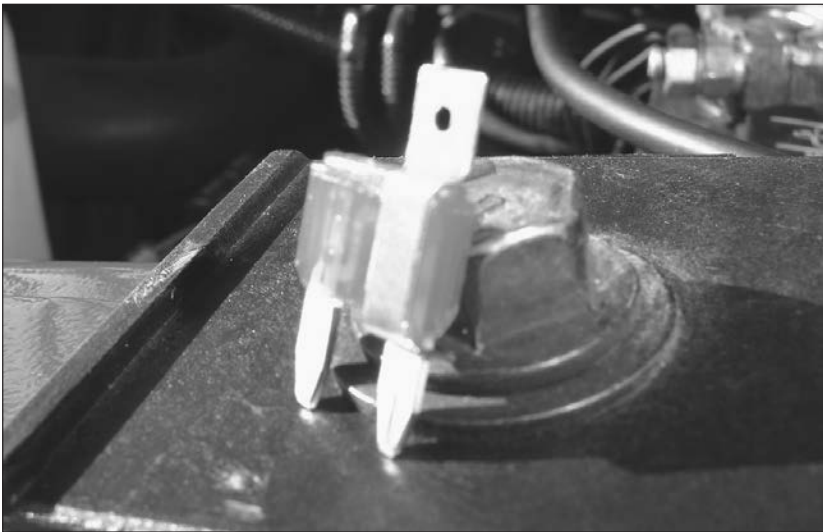

Figure 3 Fuse Tap Installation



11. Insert the male 24 pin connector on the SpeedBrake harness into the female 24-pin connector on the factory harness. Insert the female 24-pin connector on the SpeedBrake harness onto the male 24-pin connector of the factory harness.

NOTE: If vehicle is equipped with a Banks Tuner, disconnect the 24-pin connection between the factory 24-pin connectors and the Banks Tuner 24-pin connectors. It is not important if the intercepting connection is made before the Banks Tuner connection or after. This will not affect the performance of the Banks Tuner or SpeedBrake. Insert the male 24 pin connector on the SpeedBrake harness into the female 24-pin connector on the factory harness or Banks Tuner's harness. Insert the female 24-pin connector on the SpeedBrake harness onto the male 24-pin connector of the factory harness or Banks Tuner's harness.

If a Banks Diesel Tuner has been previously installed, skip step 12.

12. Locate the rubber grommet on the driver's side of the vehicle firewall. The grommet is about 3" in diameter. Make a 1" x 1" cross-shaped incision in the grommet. See **Figure 4**

4. Now from inside the cab locate the grommet on the firewall and make another 1" x 1" cross-shaped incision on the grommet.

13. Locate the In Cab Cable on Banks SpeedBrake wire harness and feed the single connector cable through the incision made in the firewall grommet and into the cab.

14. With the SpeedBrake Module positioned on top of the fuse box, peel the protective backing from the hook and loop interlocking fasteners and attached to the SpeedBrake Module. Position the SpeedBrake module to the edge closest to the engine of the fuse cover then press the adhesive onto the outside of the fuse box cover. Apply light pressure to the SpeedBrake

Figure 4 Driver Side Firewall, Rubber Grommet



Figure 5 Placement of Banks Tuner on top of the Fuse Box.

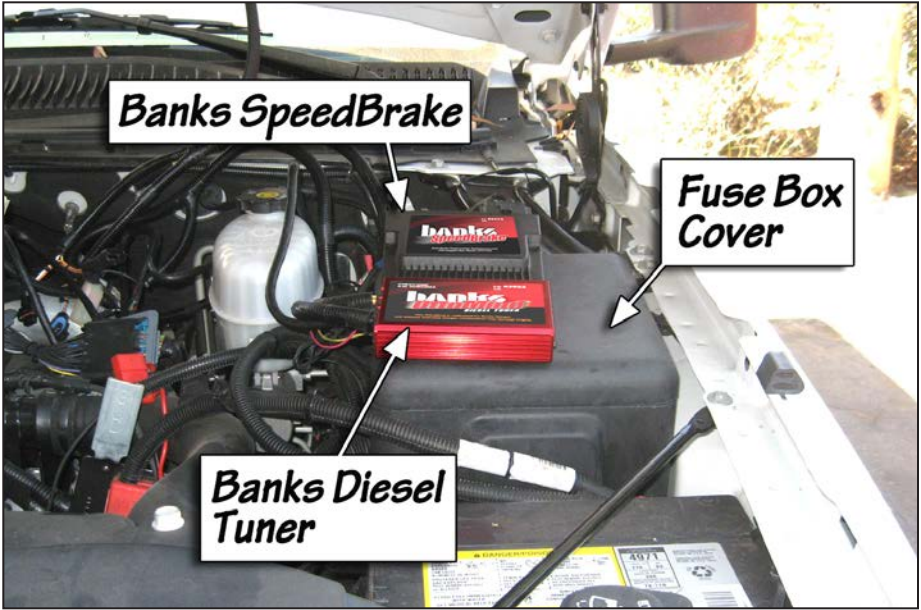

Figure 6 Placement of Banks Tuner on side of the Fuse Box.



Module by hand for 60-seconds to create a strong bond between the fuse box and hook & loop interlocking fasteners.

NOTE: make sure the fuse box cover is clean and free of any oil residue and contaminants. Clean fuse box cover with a non-oil based solvent such as Acetone, Mineral Spirits, Denatured Alcohol or Lacquer Thinner. Read and follow the manufactures operation instruction for non-oil based solvent cleanser.

*If vehicle is equipped with a Banks Tuner, detach the Tuner from the top of the fuse box cover and reattach on the fuse box side or on top of the fuse box along with the SpeedBrake. See **Figure 5 & 6**. If placing the Tuner on top of the fuse box along with the SpeedBrake module there may be some over hang from the tuner. Secure the tuner so that it stays in*

place. Use the supplied hook & loop interlocking fasteners to make the necessary adjustment to attach the SpeedBrake to the top of the fuse box cover and Banks Tuner to the fuse box side or top.

WARNING: Make sure to place the SpeedBrake Module as shown in Figure 7 to avoid a clearance issue when closing the hood. Mount the SpeedBrake Module as close to the inside edge of the fuse cover as possible.

15. Insert the SpeedBrake 20-pin Module Connector on the wire harness to the SpeedBrake Module. Using the supplied cable ties, secure the wire harness away from any heat sources (i.e. Driver side exhaust manifold) or moving components.

-END, SECTION 1-

Figure 7

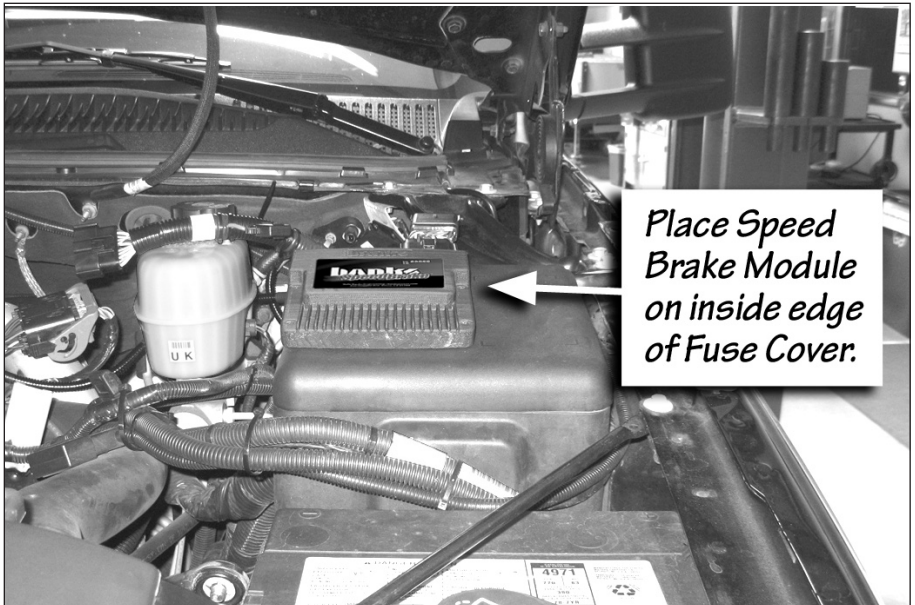

Section 2

MOUNTING THE DOCKING STATION AND CONNECTING THE BANKS POWERPDA

NOTE: This system has been designed for use with the Palm Tungsten E2 PDA.

WARNING: The PDA may be susceptible to damage as a result of extended exposure to sunlight, heat or extreme cold. It is highly recommended that the PDA be removed from its mounting location if the vehicle will be subjected to high concentrations of sunlight, heat or cold for an extended period of time. Gale Banks Engineering is not responsible for damage to PDAs resulting from exposure conditions.

CAUTION: Do not use force when working on plastic parts. Permanent damage to the part might result.

1. Locate the universal mount and docking station in your kit. Interlock the docking station to the universal mount by inserting and sliding the universal mount tabs into the docking station grooves. See **Figure 8**.

2. Find a smooth, flat surface suitable for ease of access and viewing of the PowerPDA. See **Figure 9** for an example. Loosen both knobs and move the swivel suction plate and docking station to achieve desired viewing angle of the PowerPDA screen. Do a test fit and note the angle necessary to achieve the correct viewing angle.

3. Tighten both knobs to lock in the position (**Figure 8**).

NOTE: If the universal mount swivel does not move or is tight after loosening the hold down knob, then remove the previously inserted docking station and slightly loosen the tension screw. See **Figure 10**.

4. With the alcohol swab from your kit, clean the suction cup and the mounting area and let dry. With the suction lever in the up position ensure the suction cup is flat against the windshield or smooth, flat surface. Then, push the suction lever down to secure in place

Figure 8

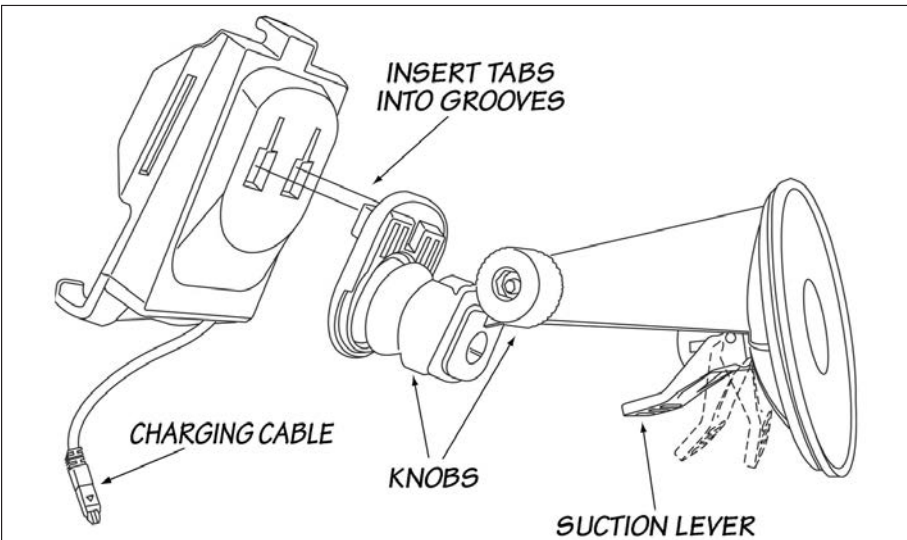
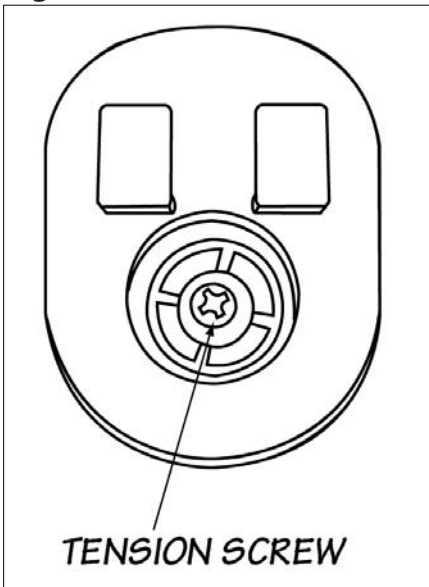

Figure 9



Figure 10



5. Find the Banks OBD II Interface Cable in your kit. Connect the Banks Interface Cable to the vehicle's OBD II connector. Use a cable tie, as shown in **Figure 11**, to secure the Banks Interface Cable to the vehicle's OBD II connector.

6. Next, connect the 6-terminal connector on the Banks OBD II Interface Cable to the 6-pin connector on the Banks SpeedBrake wire harness.

*NOTE: If your vehicle is equipped with a Banks Diesel Tuner, Optional Tuner-to-SpeedBrake cable will be needed (P/N 55411). See **Figure 12**. Disconnect the 6-pin terminal connections between Banks OBD II Interface Cable and Banks Diesel Tuner. Connect the OBD II 6-pin male connector to the optional Tuner-to-SpeedBrake 6-pin female connector. Connect the two (2) wire 6-pin male*

Figure 11



connector to the SpeedBrake female 6-pin connector and connect the four (4) wire 6-pin male connector to the Diesel Tuner female 6-pin connector.

7. For the cleanest PowerPDA installation (**Figure 9**), remove the fuse access panel by pulling it out from the side of the dash. Route the RJ12 connector (phone like connector) on the Banks OBD II Interface Cable under the dash and out where the fuse access panel was. The RJ12 connectors's cable can be slid under the door frame's seal and run up to the top of the dash. Plug the RJ12 connector into one of the receptacles in the base of the PDA docking station. Re-install the fuse access panel.

8. Your Docking Station is now installed and is ready for the Banks PowerPDA. Install the Banks PowerPDA into the Docking Station. Be sure the Banks PowerPDA is completely seated in the Docking Station against the lower support bracket.

NOTE: There may be a snug fit when installing the PowerPDA into the docking station. Do not apply excessive force during PDA installation.

9. Plug the docking station's charging cable (seen in **Figure 8**) into the charging receptacle on the lower edge of the PowerPDA.

Figure 12 *Optional Tuner-to-SpeedBrake wire*

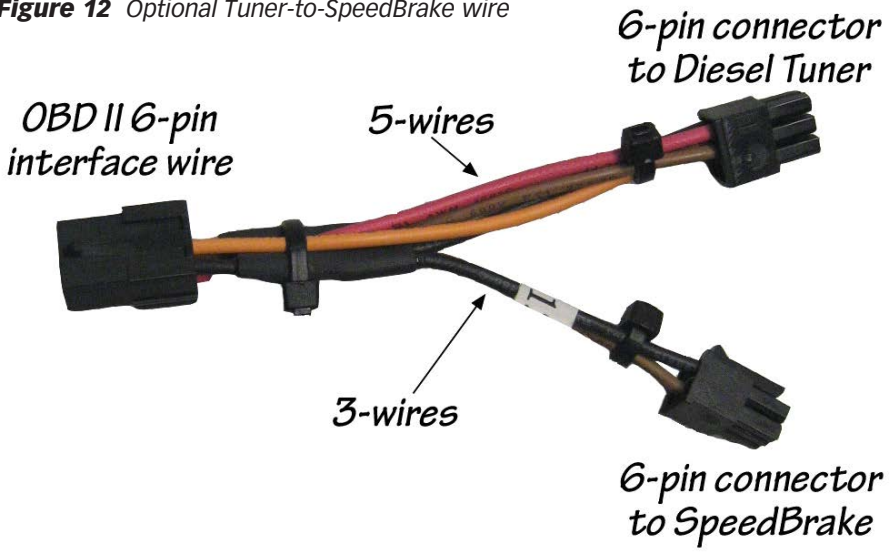

WARNING: The charging cable on the docking station is designed to supply a constant low-voltage power source (+5vdc) to the Banks PowerPDA and is "live" as long as the system's OBD II Interface Cable is completely installed and the RJ12 connector is plugged into the docking station. Although this charging cable is short and its circuitry is fuse protected, the user is expected to take appropriate measures to prevent small children and/or pets from contact with any part of this system.

10. Route all wiring away from any pedals or other moving components. Using the cable ties supplied, secure the wiring under the dash.

11. Double check everything to make sure it is securely fastened and it is not near any heat sources or moving parts before starting engine.

12. Set up the Banks PowerPDA according to its instructions.

13. Re-connect the negative (ground) cable(s).

-END, SECTION 2-

Section 3

BANKS SPEEDBRAKE POWERPDA SOFTWARE & INSTALLATION

Figure 13 Front view

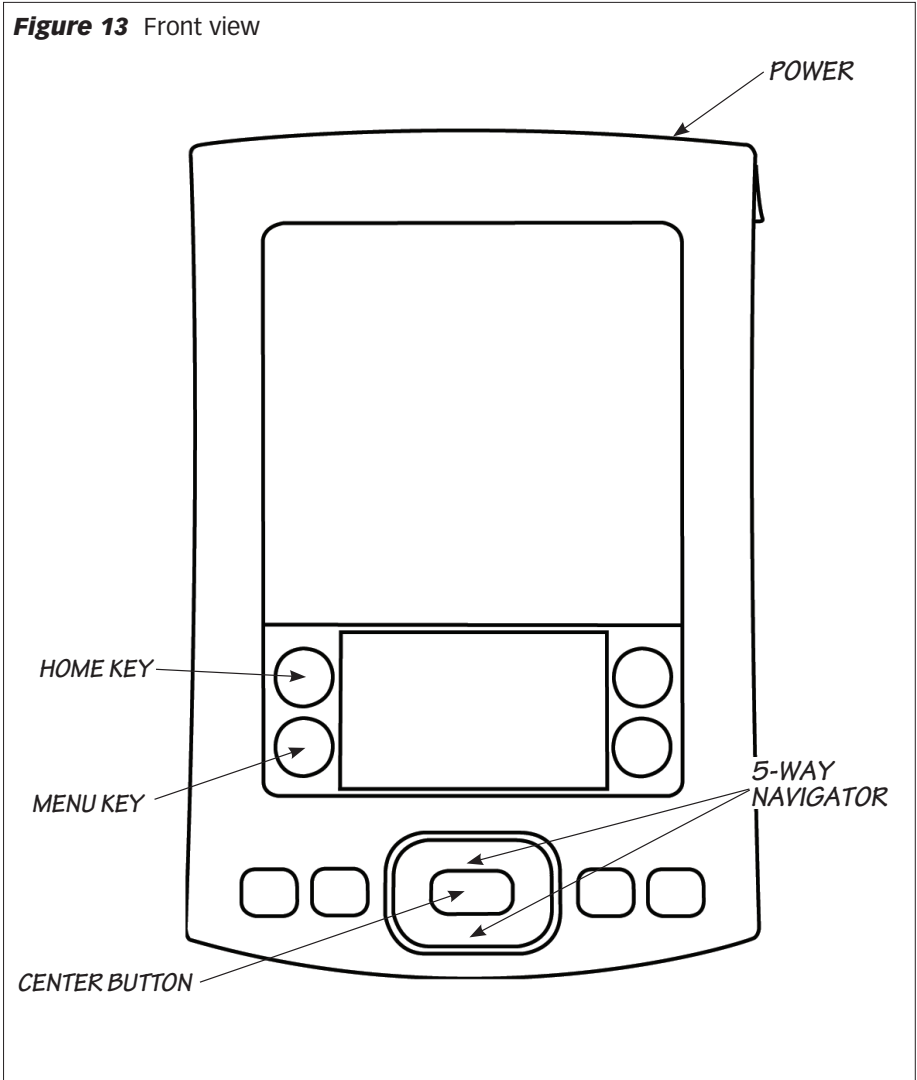

The SpeedBrake PowerPDA software is supplied on a Secure Digital (SD) media card. The software should be installed on the Palm Tungsten E2 and run from main memory. You can use the additional space on the SD card to store music, photos and other data. Refer to your device instruction manual for using SD cards to store data. You should leave a copy of the SpeedBrake PowerPDA software on the SD card as a backup for future reference.

1. Insert the SD card into the slot on the top of the Palm Tungsten E2.

*NOTE: the contents of the SD card should appear on the screen. (The "BanksBrake" name). See **Figure 16**.*

2. Press the 'Menu' key on the bottom of the Palm Tungsten E2 (beneath the 'Home' key, see **Figure 13**). Then select 'Copy'. See **Figure 14**.

Figure 14

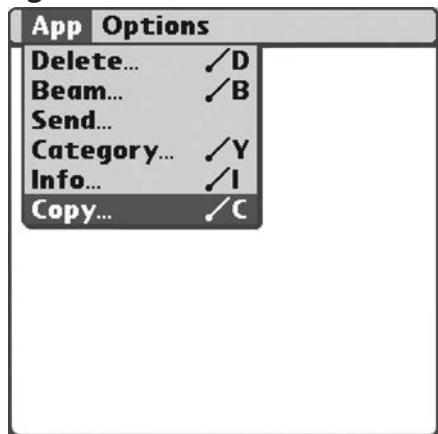

3. In the 'Copy From' drop down menu select "Card". See **Figure 15**. The 'Copy To' selection will automatically change to "Device" (**Figure 16**). Select on the "BanksBrake" name, if it is not already selected or there is more than one item in the list. Touch the "Copy" button. A dialog box will appear, indicating the Palm Tungsten E2 is copying the software from the SD card (**Figure 17**). Once completed, press the "Done" button.

4. Select the drop-down menu in the upper right hand corner of the screen. Touch the button labeled 'All'. The Banks SpeedBrake PowerPDA software is now installed. You may now remove the SD Card from its slot.

5. To start the SpeedBrake PowerPDA software, touch the icon called "BanksBrake". See **Figure 18**.

-END, SECTION 3-

Figure 15



Figure 16



Figure 18 Shown with Tuner program installed.

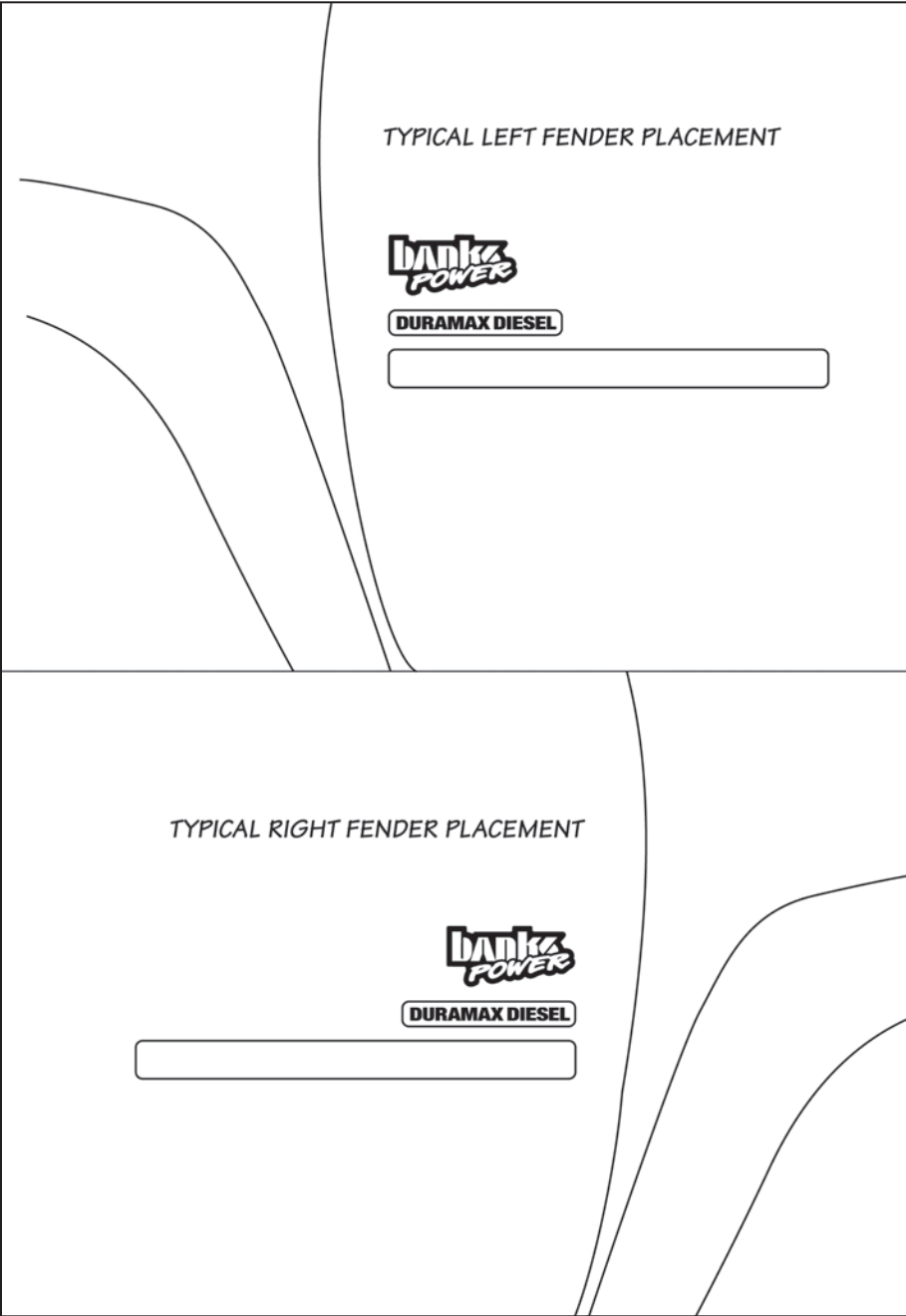

Figure 17



Section 4

PLACEMENT OF THE BANKS POWER DECALS



NOTES

Gale Banks Engineering
546 Duggan Avenue • Azusa, CA 91702
(626) 969-9600 • Fax (626) 334-1743

Product Information & Sales: (888) 635-4565
Customer Support: (888) 839-5600
Installation Support: (888) 839-2700

bankspower.com