

with Installation Instructions

Owner's Manual

Banks Brake[®]

Compatible with Installed Six-Gun[®] Power Tuner with Six-Gun Switch

**2007-2010 Chevy/GMC 6.6L (LMM)
Turbo-Diesel Pickup**

THIS MANUAL IS FOR USE WITH KITS 55449

Gale Banks Engineering
546 Duggan Avenue • Azusa, CA 91702
(626) 969-9600 • Fax (626) 334-1743

Product Information & Sales: (888) 635-4565
Customer Support: (888) 839-5600
Installation Support: (888) 839-2700

bankspower.com



Do not use this product until you have carefully read the following agreement.

This sets forth the terms and conditions for the use of this product. The installation of this product indicates that the BUYER has read and understands this agreement and accepts its terms and conditions.

Disclaimer of Liability

Gale Banks Engineering Inc., and its distributors, employees, and dealers (hereafter “**SELLER**”), shall in no way be responsible for the product’s proper use and service. The **BUYER** hereby waives all liability claims.

The **BUYER** acknowledges that he/she is not relying on the **SELLER’s** skill or judgement to select or furnish goods suitable for any particular purpose and that there are no liabilities which extended beyond the description on the face hereof and the **BUYER** hereby waives all remedies or liabilities, or otherwise, (including without any obligations of the **SELLER** with respect to fitness, merchantability, and consequential damages) whether or not occasioned by the **SELLER’s** negligence.

The **BUYER** is responsible to fully understand the capability and limitations of his/her vehicle according to manufacturer specifications and agrees to hold the **SELLER** harmless from any damage resulting from the failure to adhere to such specifications. The **SELLER** disclaims any warranty and expressly disclaims any liability for personal injury or damages. The **BUYER** acknowledges and agrees that the disclaimer of any liability for personal injury is a material term for

this agreement and the **BUYER** agrees to indemnify the **SELLER** and to hold the **SELLER** harmless from any claim related to the item of the equipment purchased. Under no circumstances will the **SELLER** be liable for any damages or expenses by reason of the use or sale of any such equipment. The **BUYER** is responsible to obey all applicable federal, state, and local laws, statutes, and ordinances when operating his/her vehicle, and the **BUYER** agrees to hold **SELLER** harmless from any violation thereof. The **SELLER** assumes no liability regarding the improper installation or misapplication of its products. It is the installer’s responsibility to check for proper installation and if in doubt, contact the manufacturer. The **BUYER** is solely responsible for all warranty issues from the automotive manufacturer.

Limitation of Warranty

Gale Banks Engineering Inc. (hereafter “**SELLER**”), gives Limited Warranty as to description, quality, merchantability, fitness for any particular purpose, productiveness, or any other matter of **SELLER’s** product sold herewith. The **SELLER** shall be in no way responsible for the product’s open use and service and the **BUYER** hereby waives all rights except those expressly written herein. This Warranty shall not be extended or varied except by written instrument signed by **SELLER** and **BUYER**.

Please see enclosed warranty information card, or go to www.bankspower.com/warranty, for warranty information regarding your product. Parts or devices outside the products kit, are not covered under Gale Banks Engineering warranty. All products that are in question of Warranty must be returned shipping prepaid to the **SELLER** and must be accompanied by a dated proof of purchase receipt. All Warranty

claims are subject to approval by Gale Banks Engineering Inc.

Under no circumstance shall the **SELLER** be liable for any labor charged or travel time incurred in diagnosis for defects, removal, or reinstallation of this product, or any other contingent expense.

Under no circumstances will the **SELLER** be liable for any damage or expenses incurred by reason of the use or sale of any such equipment.

In the event that the buyer does not agree with this agreement:

The buyer may promptly return this product, in a new and unused condition, with a dated proof-of-purchase, to the place-of-purchase within thirty (30) days from date-of-purchase for a full refund, less shipping and/or restocking fee.

The installation of this product indicates that the buyer has read and understands this agreement and accepts its terms and conditions.

Table of Contents

Also Available	4
From Banks Power	
General Installation	6
Practices	
Section 1	7
Installation of Banks Brake Wire Harness	
Section 2	15
Installation of Banks Brake Switch	
Section 3	20
Banks Brake Operation	
Section 4	22
Placement of the Banks Power Decal	
Section 5	24
Diagnostic Error Codes	

Products available From Banks Power for the 07-10 Chevy/GMC 6.6L

2007-2010 Chevy/GMC 6.6L LMM



Banks iQ System (P/N 61145-61146)

- 5" touchscreen interface that can control the Banks Diesel Tuner and/or SpeedBrake on the fly.
- Interchangeable gauge display, read and clear codes, monitor engine diagnostics, log data, time your vehicles runs and much more.

Banks Monster Exhaust System (P/N 47785, 47784)

- Increases exhaust flow, cuts backpressure, lowers exhaust gas temperatures (EGTs) and increases power.

Banks Ram-Air Intake System (P/N 42172)

- Increases your airflow over stock.
- Adds power, improves fuel economy, lowers EGTs and reduces smoke.

Banks Super-Scoop (P/N 42200)

- Adds cooler denser air to the Ram-Air Intake housing, further increasing fuel economy, reducing smoke and lowers EGTs.

Boost and Pyro Gauges (P/N 64507)

- Keep your engine safe by monitoring vital engine parameters

**Big Hoss Intake Manifold System
(P/N 42733)**

- Increases flow and provides more uniform air distribution to the engine for more available power at a given boost level.

**Banks Techni-Cooler System
(P/N 25982)**

- Provides increased air flow to the engine by increasing air density for more increased power, lower EGTs and improved fuel economy.

**Banks SpeedBrake
(P/N 55439 & 55442)**

- Allows for controlled hill decent at a user defined or preset vehicle speed.

**Banks Billet Torque Converter
(P/N 72510)**

- Higher torque capacity over stock
- Lockup clutch is slip-resistant so transmission fluids stay cooler and transmission life is prolonged.

Thermocouple

- Add a temperature limiting function to your diesel tuner.

**Banks Speed-Loader
(P/N 63838)**

- Furthers the power output of the Banks Six-Gun and provides EGT limiting safety.

**Banks Diesel Tuner
(P/N 63883 EconoMind w/ Switch
P/N 63897 EconoMind w/ iQ
P/N 63887 Six-Gun w/ Switch
P/N 63899 Six-Gun w/ iQ)**

- Adds power safely to your vehicle
- Engine and transmission safeguards
- Change power levels on-the-fly

**Banks PowerPack Systems
(P/N 47794-47795)**

Contains:

- Ram-Air Intake system
- Monster Exhaust (single or duals)
- EconoMind Tuner w/ Banks iQ
- Technis-Cooler System

**Banks Stinger System
(P/N 47792-47793)**

Contains:

- Ram-Air Intake System
- Monster Exhaust (single or dual)
- EconoMind Tuner w/ Banks iQ

**Banks Big Hoss Bundle
(P/N 47798-47799)**

- Ram-Air Intake system
- Monster Exhaust (single or dual)
- Six-Gun Tuner w/ Banks iQ
- Techni-Cooler System

**Banks Six-Gun Bundle
(P/N 47796-47797)**

- Ram-Air Intake system
- Monster Exhaust (single or dual)
- Six-Gun Tuner w/ Banks iQ

**For More Information please call (888)-635-4565
or Visit us online @ www.bankspower.com**

General Installation Practices

Dear Customer,

Your new Banks Brake is a uniquely designed braking system with electronic controls, designed to achieve the optimum level of braking from your vehicle's engine.

If you have any questions concerning the installation of your Banks Brake System, please call our Technical Service Hotline at (888) 839-2700 between 7:00am and 4:00pm (PST). If you have any questions relating to shipping or billing, please contact our Customer Service Department at (888) 839-5600.

Thank you.

1. Before starting work, familiarize yourself with the installation procedure by reading all of the instructions.
2. The exploded views provide only general guidance. Refer to each step and section diagram in this manual for proper instruction.
3. Throughout this manual, the left side of the vehicle refers to the driver side, and the right side to the passenger side.
4. Disconnect the negative (ground) cable from the battery (or batteries, if there are two) before beginning work.
5. Route and tie wires and hoses a minimum of 6" away from exhaust heat, moving parts and sharp edges. Clearance of 8" or more is recommended where possible.
6. When raising the vehicle, support it on properly weight-rated safety stands, ramps or a commercial hoist.

Follow the manufacturer's safety precautions. Take care to balance the vehicle to prevent it from slipping or falling. When using ramps, be sure the front wheels are centered squarely on the topsides. When raising the front of the vehicle, put the transmission in park (automatic) or reverse (manual), set the parking brake, and block the rear wheels. When raising the back of the vehicle, be sure the vehicle is on level ground and the front wheels are blocked securely.

CAUTION: Do not use floor jacks to support the vehicle while working under it. Do not raise the vehicle onto concrete blocks, masonry or any other item not intended specifically for this use.

7. During installation, keep the work area clean. Do not allow anything to be dropped into intake, exhaust, or lubrication system components while performing the installation, as foreign objects will cause immediate engine damage upon start-up.

8. Save this Installation Manual as a reference for system maintenance and service.

TOOLS REQUIRED:

- 1/2" and 3/8" drive ratchets with inch and metric sockets and 1/2" and 3/8" drive extension
- Inch and metric combination or open-end wrenches
- Standard & Phillips screwdriver
- Clean shop towels or rags
- Pliers
- Utility knife
- Inch-pound and foot-pound torque ratchets

Section 1

INSTALLATION OF BANKS BRAKE WIRE HARNESS

Figure 1 Banks Brake and supplied wiring harness

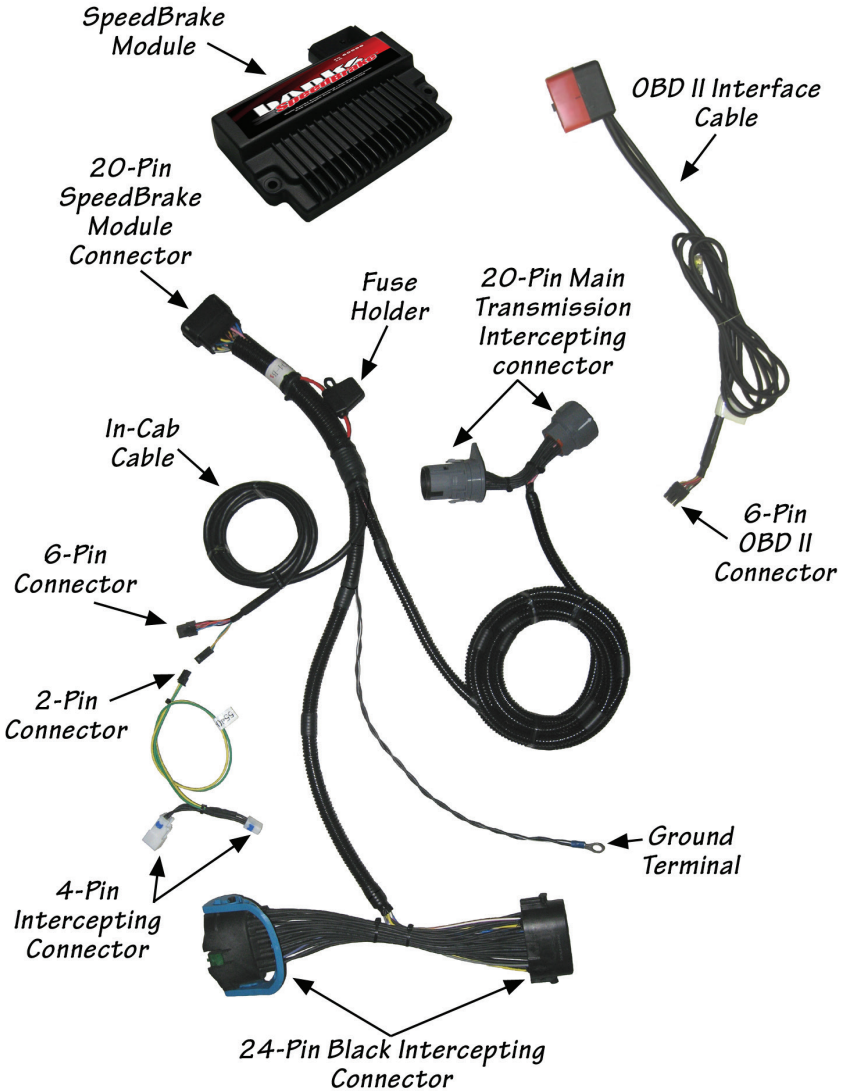

NOTE: If you have purchased a combination Banks Brake/ Tuner Package, install the Tuner first and ignore the installation of the OBD II interface cable. After completing installation of the Tuner continue with this manual.

1. Disconnect the negative (ground) cable from the battery (or batteries, if there are two) before beginning work. Secure the cables so that they do not come in contact with the battery posts during the installation.

2. Locate the Banks Brake wire harness in your kit. Start by placing the wire harness near the under hood fuse box. Run the Main Transmission intercepting connector wire harness on the Banks Brake wire harness down to the transmission following the factory transmission main connector harness from transmission control module.

3. On the right side of the transmission locate the transmission main connector. See **Figure 2**. Disconnect the connector by applying pressure on both sides and pull out.

4. Insert the female connector on the SpeedBrake wire harness into the transmission connector. Insert the factory main transmission connector to the male connector on the SpeedBrake wire harness.

NOTE: When installing the male connector to the transmission orient the arrow on the connector up.

5. Bend the heat shield as shown in **Figure 3** to relieve tension from connectors and to allow the connectors to be positioned away from heat sources.

Figure 2 Main Transmission Connector Location

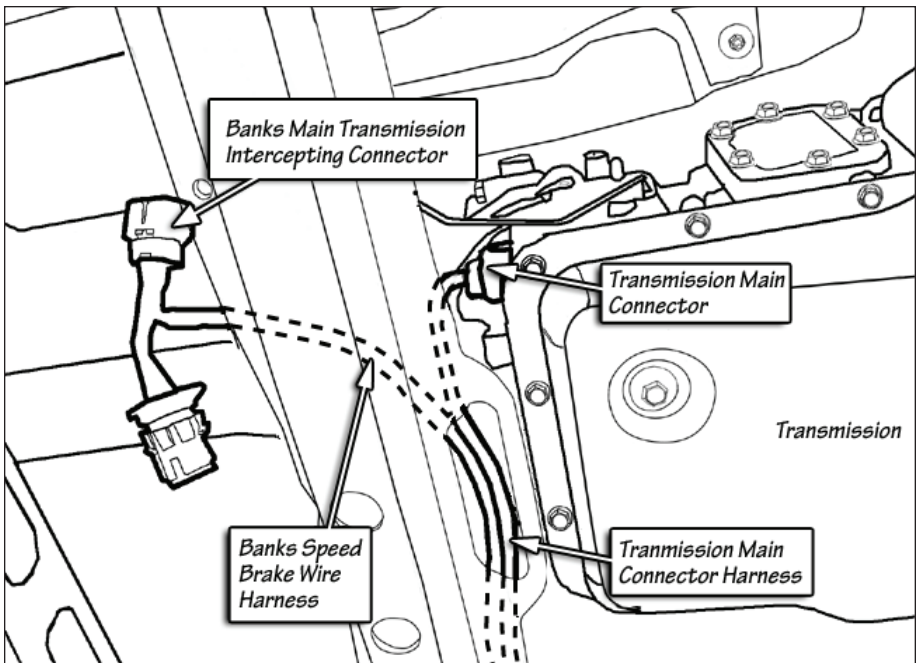

Figure 3 Heat shield alteration

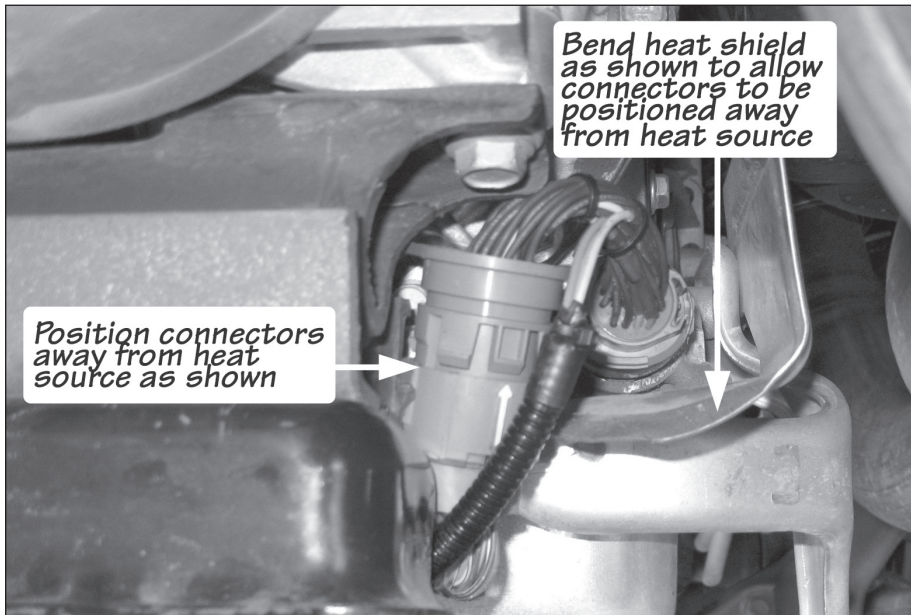
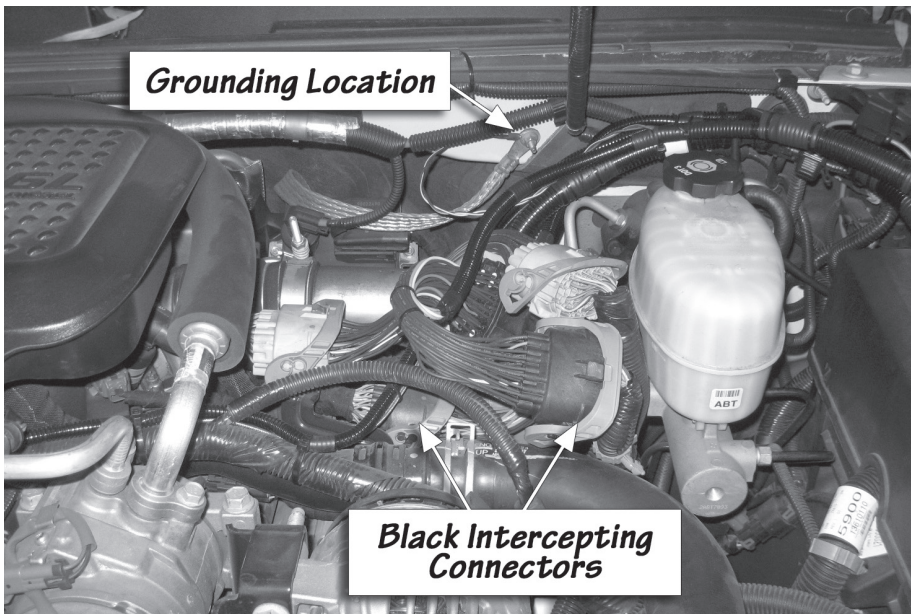

Figure 4 Grounding Location & Black Intercepting Connectors Shown



6. Secure the wire harness using some of the supplied cable ties along the factory wire harness up the left side of the engine to the Fuse box.

7. Locate the black wire harness locking connectors between the brake fluid reservoir and the air conditioning compressor. Lift the blue connector locks and disconnect the black connector pair. See **Figure 4**.

8. Insert the male black connector on the Banks Brake wire harness into the female black connector on the factory harness. Insert the female black connector on the Banks Brake wire harness onto the male black connector of the factory harness.

NOTE: If vehicle is equipped with a Banks Tuner, disconnect the black connectors between the factory and the Banks Tuner connection. It is not important if the intercepting

connection is made before the Banks Tuner connection or after. This will not affect the performance of the Banks Tuner or Banks Brake. Insert the male black connector on the Banks Brake wire harness into the female black connector on the factory harness or Banks Tuner's harness. Insert the female black connector on the Banks Brake wire harness onto the male black connector of the factory harness or Banks Tuner's.

9. Attach the Ground ring Terminal to an existing bolt on the firewall by removing the existing nut and sliding the ring terminal over the bolt. Re-install the nut and tighten to 80 lb-in. See **Figure 4**.

NOTE: Make sure your ground location is clean from dirt, grease and corrosion or the Banks SpeedBrake may not function properly.

Figure 5 Driver Side Firewall Engine Compartment, Rubber Grommet

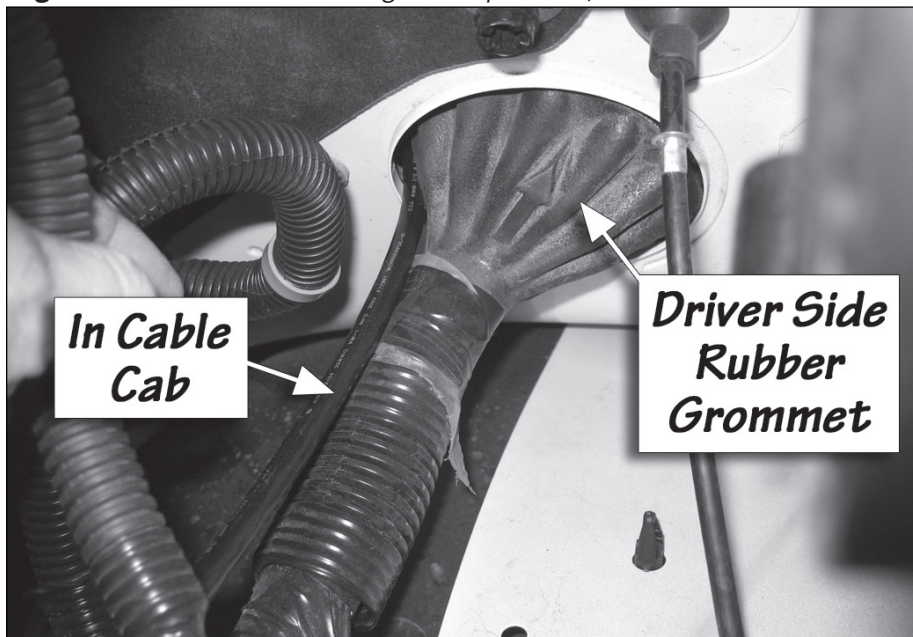
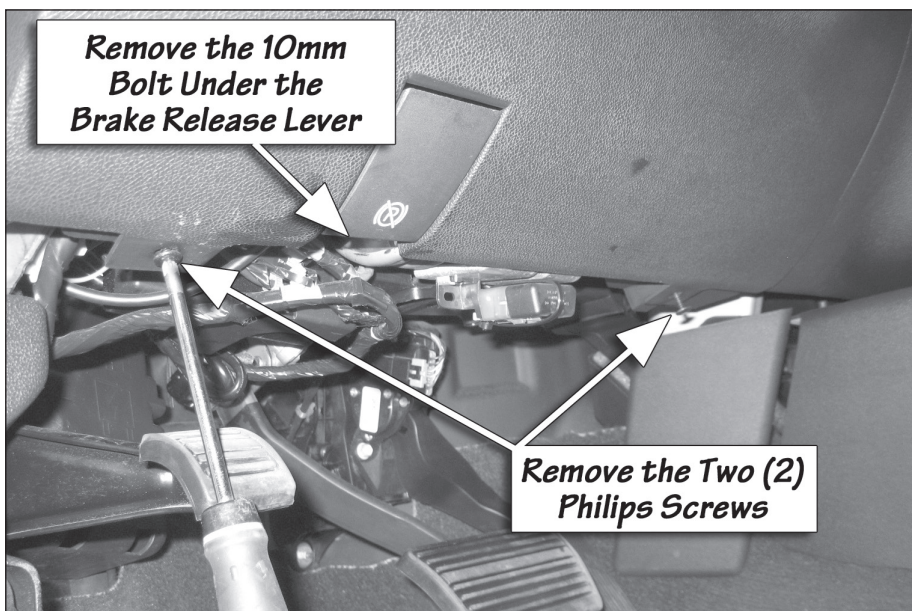

Figure 6 Fuse Access Panel Location



Figure 7



If a Banks Diesel Tuner has been previously installed, skip step 11.

10. Locate the rubber grommet on the driver's side of the vehicle firewall. The grommet is about 3" in diameter. Make a 1" x 1" cross-shaped incision in the grommet. Be careful not to cut or damage the factory wire harness. See **Figure 5**. Locate the grommet on the firewall from inside the cab and make another 1" x 1" cross-shaped incision on the grommet.

11. Feed the two-connector in-cab cable from the main wire harness through the incision made in the firewall grommet and into the cab.

NOTE: Disconnect the 4-pin Intercepting connector Harness with label 55404-9x from the main harness before routing through firewall.

CAUTION: Pull gently to avoid damage to the cable connectors.

Always pull on the cable sheath rather than the wires themselves.

12. From inside the cab remove the fuse access panel shown in **Figure 6**.

13. Remove the lower knee bolster panel by removing the two (2) Phillips screws on the lower edge of the panel. Using a 10mm socket and ratchet, unbolt the brake release lever. Retain all hardware for reuse. See **Figure 7**.

14. Pull the panel out by grasping it on either side of the steering column and pull out as shown in **Figure 8**. Disconnect any switch wires.

CAUTION: Do not use force when working on plastic parts. Permanent damage to the part may result.

15. Connect the 4-pin intercepting wire harness to the 2-pin connection on the SpeedBrake in cab cable.

Figure 8 Removal of Knee Bolster



16. Under the steering column locate the 4-pin connection and disconnect. See **Figure 9**.

17. Insert the male 4-pin connector from the Speed Brake harness into the female 4-pin connector on the factory harness. Insert the female 4-pin connector on the SpeedBrake harness onto the male 4-pin connector of the factory harness. Secure the wire harness with the supplied ties under the dash.

18. The lower knee bolster panel and the Fuse panel will be reinstall in the next section.

WARNING: Take care to keep any cables away from the pedals or where they could become tangled.

19. With the Banks Brake Module positioned on top of the fuse box, peel the protective backing from the hook and loop interlocking fasteners and attached to the Banks Brake Module. Position the Brake module to the edge closest to the engine of the fuse cover then press the adhesive onto the outside of the fuse box cover. See **Figure 10**. Apply light pressure to the Brake Module by hand for 60-seconds to create a strong bond between the fuse box and hook & loop interlocking fasteners.

NOTE: make sure the fuse box cover is clean and free of any oil residue and contaminates. Clean the fuse box cover with a non-oil based solvent such as Acetone, Mineral Spirits, Denatured Alcohol or Lacquer Thinner. Read and follow the manufactures operation instruction for non-oil based solvent cleanser.

Figure 9 Location of 4-Pin Connector Under Steering Column

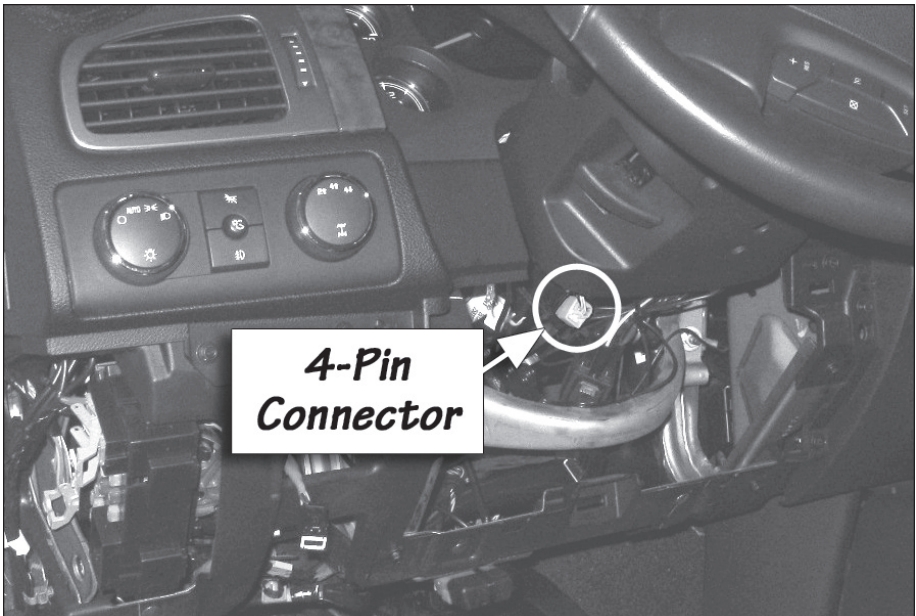
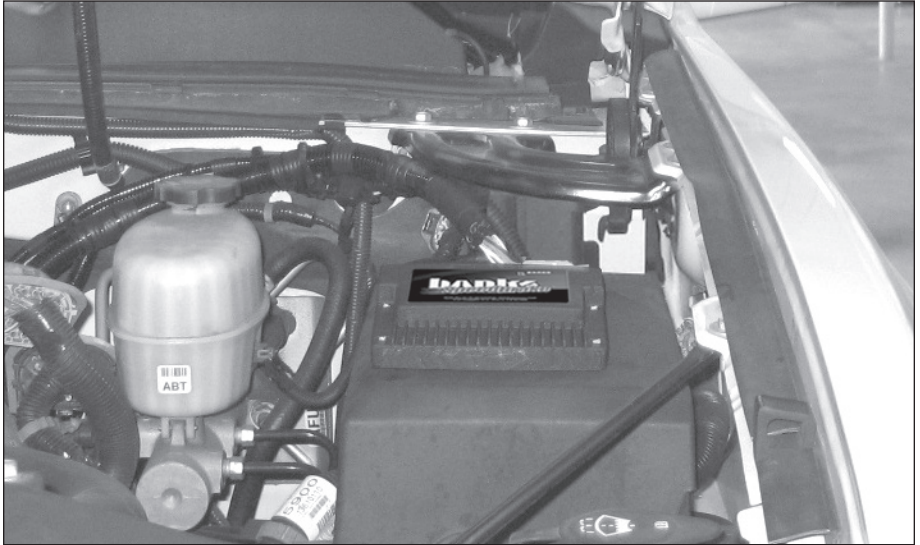

Figure 10 Placement of the Banks Brake Module



If vehicle is equipped with a Banks Tuner, the Banks Brake can be installed next to the Banks Tuner.

20. Insert the Banks Brake 20-pin female connector on the wire Harness to the Banks Brake Module. Using the supplied cable ties, secure the wire harness away from any heat sources (i.e. Driver side exhaust manifold) or moving components.

21. Locate the Banks OBD II Interface Cable in your kit. This cable has three connection points. Connect the RED OBD II connector on the Banks interface cable to the vehicle OBD II connector. Use a cable tie as shown in **Figure 11** to secure the Banks interface cable to the vehicle OBD II connector.

22. Next, connect the 6-pin connector on the Banks OBD II interface cable to the 6-pin connector on the Banks Brake wire harness routed through the firewall.

23. The RJ12 connector (phone like connector) on the Banks Brake Wire harness will be connected in the next section to the Brake level selector switch. Leave this wire loose for connecting to Brake level switch.

24. Go over all connection. Secure the wire harness with the supplied ties under the dash.

WARNING: Take care to keep any cables away from the pedals or where they could become tangled.

-END, SECTION 1-

Figure 11

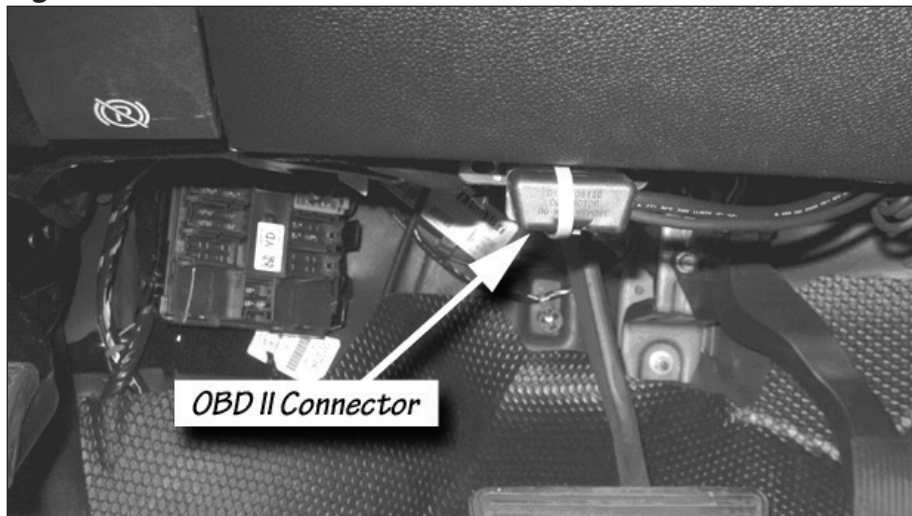

Section 2

INSTALLATION OF BANKS BRAKE SWITCH

CAUTION: Do not use force when working on plastic parts. Permanent damage to the part may result.

NOTE: Before drilling, confirm that there is adequate room for the Switch and wires behind the dash. Make sure wires or obstructions are cleared from the drilling area.

1. The Banks Brake Switch can be installed on the driver's side of the instrument panel (IP) to the left side of the steering column. There are two dash types: Dash 1 (**Figures 12, 13**) and Dash 2 (**Figures 14, 15**).

NOTE: These are just suggested locations. It is possible to locate the Banks Brake Switch where it is more comfortable. Please confirm space behind dash before drilling.

2. To install on the driver's side IP (Dash 1, **Figure 12**):

Pull the IP trim out by pulling the top edge above the vent as shown in **Figure 16**. Disconnect any switch wires.

3. Cut out the supplied template, **Figure 21 on page 23**, and align the dashed lines to the edge of the IP where you would like to mount the Switch. Tape the template in place. Continue to Step 7.

4. To install the Switch to the left side of the steering column (Dash 2 **Figure 15**):

Remove the fuse access panel shown in **Figure 6**. Remove the lower knee bolster panel by removing the 2 Phillips screws on the lower edge

Figure 12



Figure 13

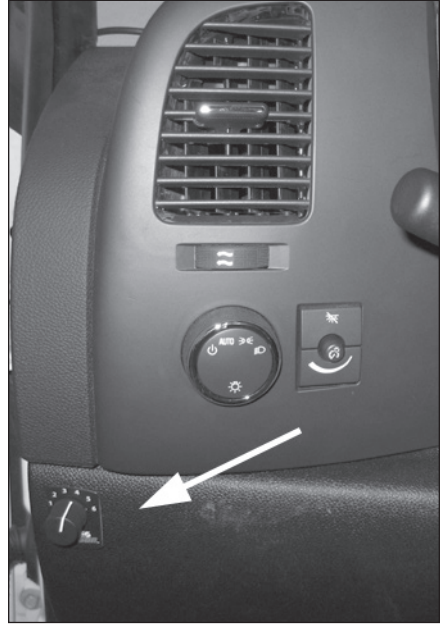

of the panel. Using a 10mm socket and ratchet, unbolt the brake release lever. Pull the panel out by grasping it on either side of the steering column and pull out as shown in **Figure 17**. Disconnect any switch wires.

5. Cut out the supplied template, **Figure 21 on page 23**, and align the template to the right edge of the IP to the left of the steering column. Tape the template in place. A 90° drill will be needed to drill the hole. Continue to Step 7.

6. To install Switch as shown in **Figures 13 & 14**:

Follow Step 4 to remove the IP for both Dash styles. Cut out the supplied template, **Figure 22 on page 23**, and align the template onto the rear of the knee bolster, squarely seating it into the panel corner as shown in **Figure 18**.

7. Using a 3/8" Uni-bit step drill bit or a 3/8" drill bit, center the bit onto the 3/8" drill location on the template and slowly drill through the IP. Using a 1/8" drill bit, center and drill through the 1/8" location on the template. Remove and discard the template and any plastic shavings.

8. On the front side of where the Switch will be mounted, clean the area with some alcohol and allow it to dry. Remove the backing from the Banks Brake Label and align it over the previously drilled hole.

9. Remove the nut and internal tooth washer from the Banks Brake Switch. Rotate the shaft counter clockwise until the shaft stops. Verify the locating washer tab is inserted into the #5 position on the Switch (**Figure 19**).

NOTE: If the washer is in any position other than the #5, your Banks Brake will not select power levels properly.

Figure 14



Figure 15



Figure 16



10. After confirming the locating washer is in the #5 location, install the Switch through the $\frac{3}{8}$ " hole. The alignment pin should rest in the $\frac{1}{8}$ " hole. With the Switch fully rotated counter clockwise the shaft's flat side should be facing the steering column. Secure the Switch with the internal tooth washer and nut. Snug the washer; be careful not to over torque the nut and damage the plastic threads.

11. Install the knob onto the shaft facing the Off Level on the Banks Brake label. On the knob, snug the two (2) set screws with the supplied 0.050" hex key wrench.

12. Route **the RJ12 connector (phone like connector)** to the Banks Brake switch cable connector, and plug the connectors together.

13. Reinstall any panel(s) that were removed, make all electrical connections that were disconnected. Secure all loose wiring under the dash with supplied cable ties.

WARNING: Take care to keep any cables away from the pedals or where they could become tangled.

14. Re-connect the negative (ground) cable(s).

-END, SECTION 2-

Figure 17



Figure 18- Rear template used



Figure 19

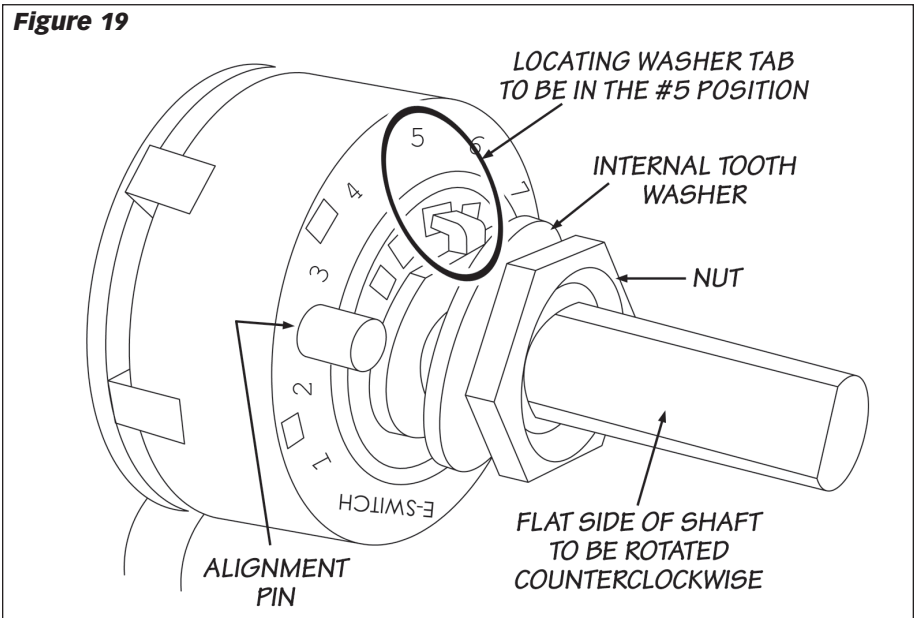

Section 3

BANKS BRAKE OPERATION

The Banks Brake has five (5) operating settings; HIGH, MED (medium), LOW, OFF and FB (Foot Brake Activation). See **Figure 20**.

Figure 20: Banks Brake Selector Switch Guide



OFF mode allows the vehicle to behave as if the Banks Brake is not present.

When the selector switch is turned to the LOW, MED, HIGH settings the Banks Brake will activate and will downshift the transmission and adjust the turbocharger vanes, resulting in a braking effect that slows your vehicle to 15 mph.

HIGH strength achieves the highest level of braking force by aggressively downshifting the transmission and closing the turbocharger vanes. This setting is recommended for heavily loaded vehicles or whenever aggressive braking is desired.

MED (medium) strength achieves a moderate level of braking force by slightly delaying transmission downshifts. This setting is recommended for moderately loaded vehicles.

LOW strength setting achieves a lower level of braking force and is recommended for lightly loaded or unloaded vehicles. The LOW setting may also be used for daily driving.

CAUTION: Using the HIGH setting with a lightly loaded vehicle will result in VERY aggressive braking. Become familiar with the characteristics of the Strength Settings before encountering slippery road conditions, including rain, snow and icy.

Foot Brake Activation

When Foot Brake Activation is selected the Banks Brake will only activate when the foot brake is applied. In this setting the Brake will apply the highest level of braking force to assist in slowing the vehicle.

To Enable Foot Brake Activation, turn the Brake selector switch to the Foot Brake Activation (FB) level. To Disable, turn the switch to any other desired level.

CAUTION: Your Banks Brake is NOT a substitute for the hydraulic brakes on your truck. The device will not correct or compensate for improperly maintained hydraulic brakes. Also, please be aware that your Banks Brake is not designed to be used as a parking brake or to bring your vehicle to a complete stop. Your Banks Brake is a supplementary braking system designed to help you slow down or to assist you in maintaining a more constant speed when descending a grade. Remember that Banks Brake is first and foremost a preemptive device and is most efficient when used to help prevent, rather than correct, a vehicle over speed situation.

The use of a Banks Brake does not increase the load capacity of your vehicle. Gross combined Weight Rating specifications should always be adhered to. The Banks Brake will allow you to slow your vehicle more effectively within your vehicle's weight specifications.

OPERATION/DRIVING

Now that you are familiar with the features that are available with Banks Brake, it is recommended that you experiment with the various settings prior to using the braking features in a towing or extreme driving situation. Under light load conditions on local streets, the MED (medium) setting is an appropriate starting point to provide a reasonable demonstration that the brake is functioning.

NOTE: Whenever the brake is active and the footbrake is applied, the vehicle will not upshift until the throttle is pressed. This is also true even if cruise control is resumed.

For some model vehicles, whenever the brake is active the vehicles Tow-haul mode will activate. The tow-haul mode will deactivate when the Banks Brake is deactivated.

WHEEL SLIP DETECTION

The Banks Speedbrake continuously monitors wheel speeds to detect possible slippage caused by braking. If this occurs, the brake will shut off until traction is regained and then remain off for 30 seconds. This will be communicated as a fault via the Banks iQ Status Indicator.

-END, SECTION 3-

Section 4

PLACEMENT OF THE BANKS POWER DECALS

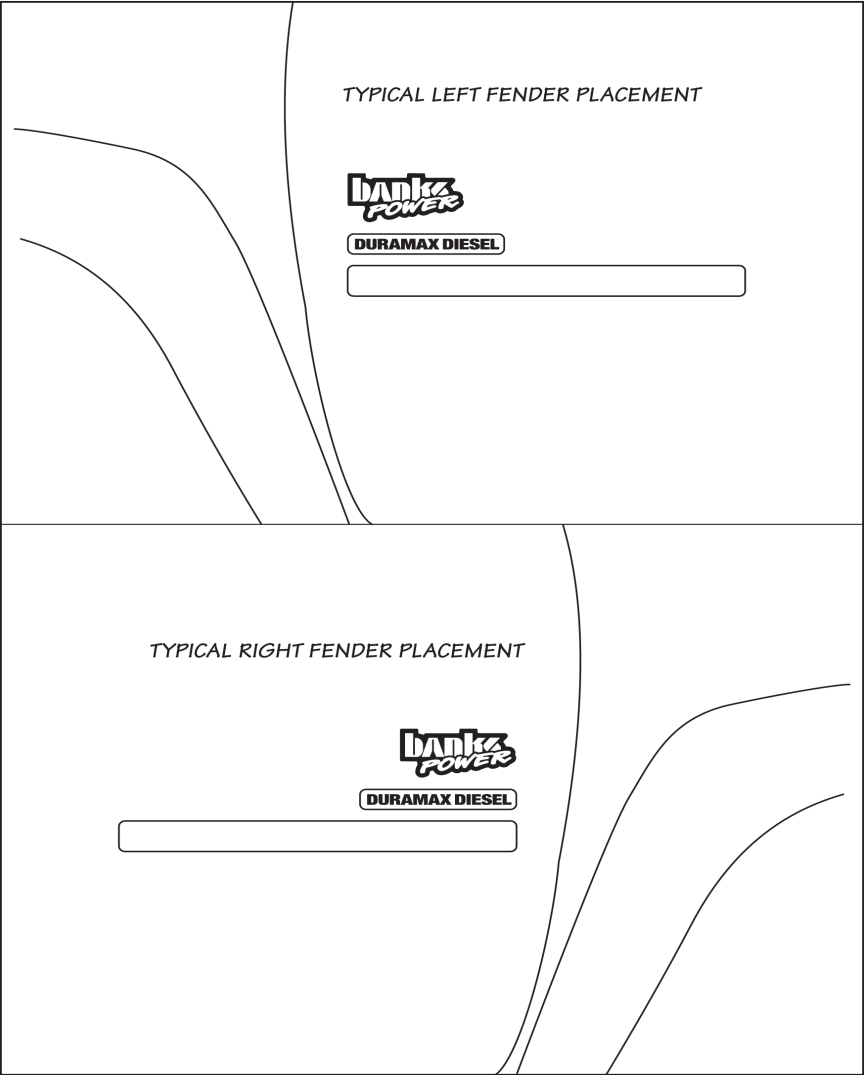

Figure 21- Use only when drilling from the front

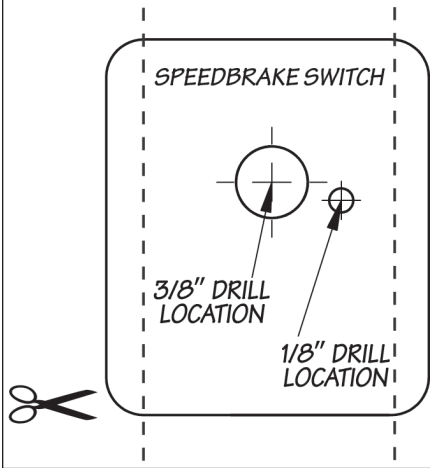
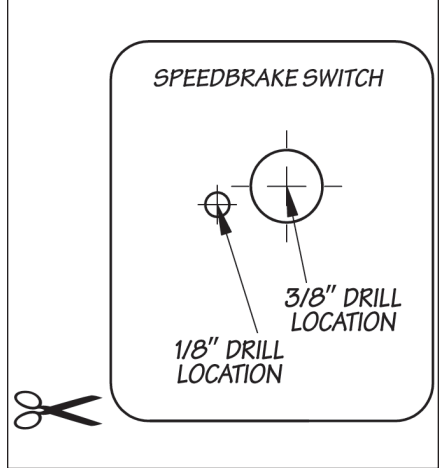

Figure 22- Use only when drilling from the rear



Section 5

DIAGNOSTIC ERROR CODES

Table 1 - (For 07-10 model years)

Flash Code	iQ Error Message	Corrective Action – LBZ/ LMM
1,1	Code 11: VGT control input out of range.	Turn ignition OFF and check the 40-Pin connector. Turn ignition back ON and re-check for presence of code. If problem persists, call Gale Banks Engineering Tech Support.
1,2	Code 12: Vane Position Sensor input out of range.	Turn ignition OFF and check the 40-Pin connector. Turn ignition back ON and re-check for presence of code.
1,3	Code 13: Rear wheels slipping.	None required. When traction is regained, error will clear after 30 seconds.
1,4	Code 14: Low power voltage detected.	Turn ignition OFF and check the 40-Pin connector and the Ground O-ring. Turn ignition back ON and re-check for presence of code.
2,1	Code 21: VGT control output malfunction.	Turn ignition OFF. Turn ignition back ON and re-check for presence of code.
2,2	Code 22: VGT control output overcurrent.	Turn ignition OFF and check the 40-Pin connector. Turn ignition back ON and re-check for presence of code.
2,3	Code 23: Low relay voltage detected.	Turn ignition OFF. Turn ignition back ON and re-check for presence of code.
2,4	Code 24: Vane Position Sensor voltage output malfunction.	Turn ignition OFF and check the 40-Pin connector. Turn ignition back ON and re-check for presence of code.
3,1	Code 31: OBD communication error.	Turn ignition off and check the OBD connector and cable. Turn ignition back ON and re-check for presence of code.
3,2	Code 32: Internal module malfunction or intermittent power.	Turn ignition OFF. Turn ignition back ON and re-check for presence of code.
3,3	Code 33: OBDII CAN communication output error.	Turn ignition OFF and check the 40-Pin connector. Turn ignition back ON and re-check for presence of code.
3,4	Code 34: OBDII CAN communication input error.	Turn ignition OFF and check the 40-Pin connector. Turn ignition back ON and re-check for presence of code.
4,2	Code 42: Torque Converter Clutch slippage detected.	Turn ignition OFF and check the 40-Pin connector. Turn ignition back ON and re-check for presence of code.
4,3	Code 43: Shift control malfunction.	Turn ignition OFF and check the 4-Pin and 20-Pin connectors. Turn ignition back ON and re-check for presence of code.
4,4	Code 44: Internal memory malfunction.	Turn ignition OFF. Turn ignition back ON and re-check for presence of code.

If problem persists, call Gale Banks Engineering Tech Support.

Gale Banks Engineering
 546 Duggan Avenue • Azusa, CA 91702
 (626) 969-9600 • Fax (626) 334-1743

Product Information & Sales: (888) 635-4565
 Customer Support: (888) 839-5600
 Installation Support: (888) 839-2700

bankspower.com