



INSTALLATION INSTRUCTIONS

150201BK/ 150201SP / 150201SPS

150203BK/ 150203SP / 150203SPS

300 W. Pontiac Way Clovis, CA 93612 toll free: 1-800-445-3767 web: www.belltech.com

07-18 SILVERADO / SIERRA 2WD / 4WD
150201 For Cast Aluminum / Stamped Steel UCA
150203 For Cast Steel UCA

Thank you for being selective enough to choose our high quality BELLTECH PRODUCT. We have spent many hours developing our line of products so that you will receive maximum performance with minimum difficulty during installation

Note: Confirm that all of the hardware listed in the parts list is in the kit. **Do not** begin installation if any part is missing. Read the instructions thoroughly before beginning this installation.

Warning: DO NOT work under a vehicle supported by only a jack. Place support stands securely under the vehicle in the manufacturer's specified locations unless otherwise instructed.

Warning: DO NOT drive vehicle until all work has been completed and checked. Torque all hardware to specified values.

Reminder: Proper use of safety equipment and eye/face/hand protection is absolutely necessary when using these tools to perform procedures!

Note: It is very helpful to have an assistant available during installation.

Note: Please refer to component and hardware list before beginning installation to insure all necessary pieces have been supplied and packaged.

Exceptional Customer Experience Guarantee:

STOP! We strive for an exceptional experience for all of our valued customers. If, for any reason, you need assistance with your Belltech products, please do not return the products to the store or website you purchased from. Please call our dedicated experts at (1-800-445-3767) from 7am to 5pm PST.

RECOMMENDED TOOLS:

- Properly rated floor jack and support stands
- Wheel chocks
- Torque wrench up to 200 ft/lbs range
- Standard and Metric socket wrench set
- Standard and Metric wrench set
- Tape measure
- Dead blow hammer
- Marking pen
- Safety Glasses
- Reciprocating Saw with metal cutting blades

BOX 1: LK1006

PART NUMBER	DESCRIPTION	QUANTITY
150201-101	Front Crossmember	1
150201-102	Rear Crossmember	1
LK1006-1	Accessory Kit	1
150201-107F	Front Compression Strut Bracket	1
150201-107R	Rear Compression Strut Bracket	1
150201-115	Reinforcement Plate	1
150201-211R	Brake Line Bracket Passenger	1
150201-211L	Brake Line Bracket Drivers	1
150201-150	Tie Rod End	2
150201-100-HW	Bushing Hardware Kit	1
LK1006-777	Hardware Kit	1
150201A-777	Hardware Pack: Front/Rear Crossmember	1
110218	M16 x 2 - 120mm Bolt	2
110281	M16 x 2 - 140mm Bolt	2
110219	M16 Flat Washer	8
110242	M16 x 2 Nylock Nut	4
150201B-777	Hardware Pack: CV Axle	1
110285	M10 x1.5 - 60mm Bolt	12
150201C-777	Hardware Pack: Replacement Strut Bolts	1
110237	M10 x 1.5 - 70mm Bolt	4
110238	M10 1.50 Nylock Nut	4
110239	M10 Washer	8
150201D-777	Hardware Pack: Differential Drop	1
110283	M14 x 2 - 45mm Bolt	2
110222	M14 x 2 Nylock Nut	2
110223	M14 Washer	2
110282	M12 x 1.75 - 45mmBolt	2
110243	M12 x 1.75 Nylock Nut	2
110228	M12 Washer	4
150201E-777	Hardware Pack: Compression Arm / Bracket	1
110227	M12 x 1.75 - 110mm Bolt	4
110228	M12 Washer	12
110243	M12 x 1.75 Nylock Nut	6
110225	M12 x 1.75 - 30mm Bolt	2

BOX 1: LK1006 Continued

PART NUMBER	DESCRIPTION	QUANTITY
150201F-777	Hardware Pack: Skid Plate Hardware	1
110226	M12 x 1.75 -100mm Bolt	1
110243	M12 x 1.75 Nylock Nut	1
110228	M12 Washer	3
110225	M12 x 1.75 - 30mm Bolt	1
150201G-777	Hardware Pack: U-Bolt	1
110240	9/16 Nylock Nut	8
110241	9/16" Washer	8
150201H-777	Hardware Pack: Brakeline Relocation	1
110286	M6x1.0 - 25mm	4
110235	M6 x 1.0 Nylock Nut	4
110117	M6 Washer	8

BOX 2: LK1007

150201-201	Lift Block	2
150201-105	Passenger Side Differential Drop	1
150201-108	Skid Plate	1
150201-204	Wheel Spacer	2
150201-104	Drivers Side Differential Drop	1
150201-202	U-Bolt	4
150201-112	Lower control Arm Supports	2
150201-106	Compression Strut Arm	2
150201-209	CV Axel Spacer 1.25"	

BOX 3: LK2001 or LK2002

(LK2001 - For Aluminum and Stamped Upper Control Arms)

150203-103D	Driver Side Lifting Knuckle	1
150203-103P	Passenger Side Lifting Knuckle	1

or

(LK2002 - For Cast Steel Control Arms)

150201-103D	Driver Side Lifting Knuckle	1
150201-103P	Passenger Side Lifting Knuckle	1

KIT PREPERATION

Before beginning the install process, measure the hub to fender heights for your vehicle so you can compare the resulting height to the original. Measure vertically from the center of the wheel to the inner edge of the fender.

Record the results here:

LF: _____ RF: _____ LR: _____ RR: _____

Park the vehicle on a smooth, level concrete or seasoned asphalt surface and activate the parking brake. Block the REAR wheels of the vehicle with appropriate wheel chocks; making sure the vehicle's transmission is in 1st gear (manual) or "Park" (automatic).

It is very important that the vehicle is properly supported during this installation to prevent personal injury and chassis damage. Make sure that the support stands are properly placed prior to performing the following procedures. We **DO NOT RECOMMEND** using wheel ramps while performing this installation. !

FRONT REMOVAL / INSTALLATION

1. Using a vehicle hoist is recommended. If no hoist is available, jack up the front of the vehicle. Place jack stands under the frame rails and lower onto jack stands letting the front suspension hang.
2. Use the appropriate socket to undo the lug nuts and remove the wheels. Remove factory under paneling. **(PHOTO 1)**
3. Remove the sway bar from the vehicle completely by disconnecting it from the end link using a 15m wrench & socket, and removing the brackets using a 10mm socket. **(PHOTO 2)**
4. Using a 21mm wrench, remove the tie-rod nut. Strike the side of the mount with a dead blow hammer to dislodge the tie rod end. A 10mm wrench may be needed if the ball joint is spinning. **(PHOTO 3)**
5. Using a 10mm wrench and panel poppers, remove all mounting points for the brake line including the bracket on the knuckle and abs sensor wire from the control arm and spindle. Undo the brake caliper mounting bolts with an 18mm socket and remove them, hang the calipers to prevent stretching of the lines using large zip ties or hangers. Remove the rotors by removing the T30 Torx screw and put it to the side. **(PHOTO 4)**

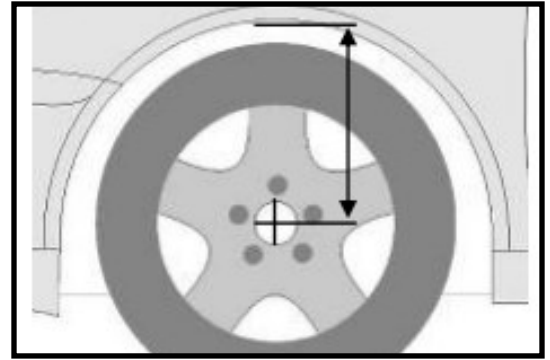

6. Remove and unplug the ABS sensor wire from the spindle using a 5mm hex key. It is important to keep the sensor key and the harness un stretched as they are very fragile. **(PHOTO 5)**
7. Remove the axle nut located underneath the dust cap (if provided) using a 36mm socket. This will help prevent the axle from pulling out of the differential and causing damage. **(PHOTO 6)**
8. Support the spindle by gently lifting against it with a jack. This is to prevent the spindle assembly from falling during the next two steps.
9. Loosen the upper ball joint nut using a 19mm wrench. Strike the spindle on the designated bosses to help separate the upper control arm from the spindle. Remove Nut. Be careful, the upper control arm could be under tension. Allow the spindle to droop as you slide the axle shaft out of the hub. **(PHOTO 7)**
10. Remove the lower ball joint nut using a 24mm wrench and strike it on the designated bosses to separate from the lower control arm. Be sure to hold the spindle as it breaks free to prevent damage. Place the spindle aside as you will need to remove the hub later in the instructions. **(PHOTO 8)**
11. Uninstall the strut. The top nuts can be removed with an 18mm wrench. Remove the hardware holding the bottom of the strut to the control arm using a 15mm socket and remove the strut from the vehicle. **(PHOTO 9)**

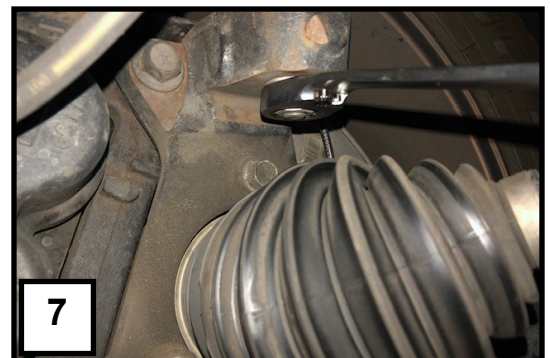

12. Remove the CV axle by removing the 6 bolts attaching it to the front differential using a 15mm socket. **(PHOTO 10)**

13. Remove the lower control arms from the frame using an 18 & 24mm socket. A breaker bar may be required.

14. Remove the OEM equipped plastic gravel guards.

15. Disconnect the three electrical connections, rubber vent hose and the driveshaft from the differential **(PHOTO 11)**

16. Remove the 4 bolts and nuts holding the crossmember underneath the differential, and remove the crossmember. **(PHOTO 12)**

17. Locate the front tab in which the lower control arm mount. Trim the area marked in *photo 14* for both sides. This is necessary for the front crossmember to install. **(PHOTO 13)**

18. Reference **PHOTO 16** for the next step. Measure 3/4" from the edge of "HOLE: A," and mark a vertical line to cut the area of the crossmember that will interfere with the differential. **ONLY NEEDED FOR REAR DRIVER'S SIDE MOUNT.** **(PHOTO 15 & 16)**

19. It is recommended that you remove the differential completely before continuing on with the procedures. Regardless of procedure, ensure the differential is always supported.

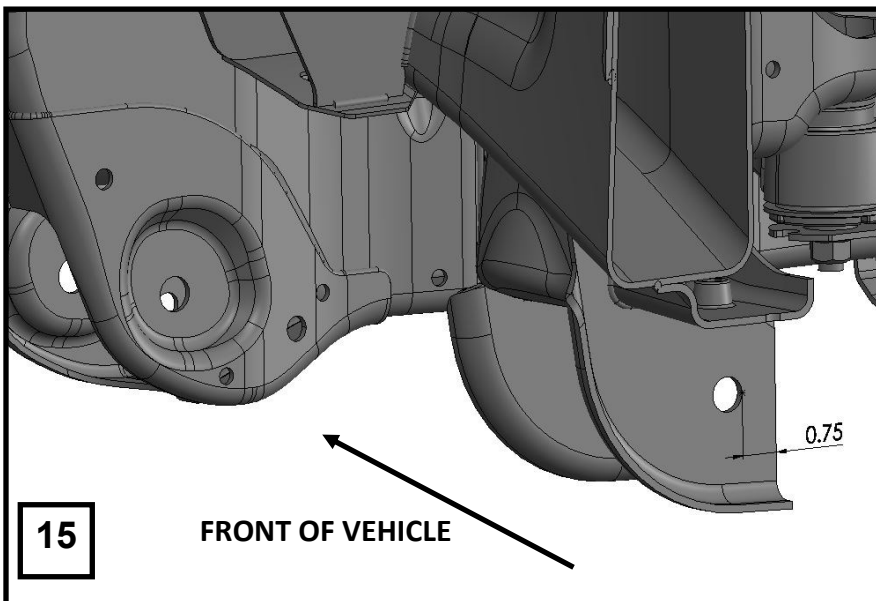
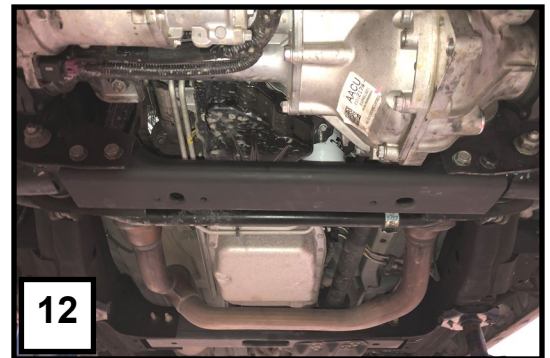
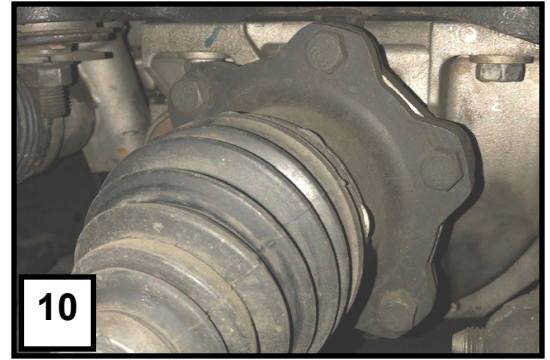

20. Install the differential drop spacers to the frame using OEM hardware. Both diff drops should have the tapered end toward the rear of the vehicle and the flat faces facing inward. **(PHOTO: 16-Drivers Side / 17-Passengers Side)**

21. Install the differential, reconnect driveshaft and electrical connections. The differential attaches to the drops using the supplied M14 hardware found within the **150201D-777** packet.

22. Install the front and rear crossmembers using OEM hardware and torque to 130 ft-lb. **(PHOTO 18/19)**

23. Install the OEM lower control arms using the M16 Bolts found within the **150201A-777** packet. Install the Lower A frame support rods. They will connect between the front and rear crossmembers and attach using the same hardware as the lower control arms.

24. Install the CV axles with the spacers between the mounting hub and the differential mounting plate. Use the 12 supplied extended CV axle bolts found within the **150201B-777** hardware packet

For Sway Bar Drop Downs:

Please refer to the included instructions for 150210-113. All required hardware is provided.

For New Sway Bar Installation:

Please refer to the included instructions within the 5426 sway bar kit. All required hardware is provided.

For Strut Spacer Installation:

Please refer to the included instructions for strut spacer 150201-120. All required hardware is provided.

For Trail Performance Strut Installation:

Please refer to the instructions for setting ride height included within the strut 28004.

For both instances use the provided M10 hardware within packet 150210E-777 for mounting the lower bushing to the control arm, bolt head up.

25. Remove the tie rod end. It is necessary to cut 1" from the end of the inner tie rod to allow for proper alignment. Install the shorten tie rod end supplied. **(PHOTO 20)**

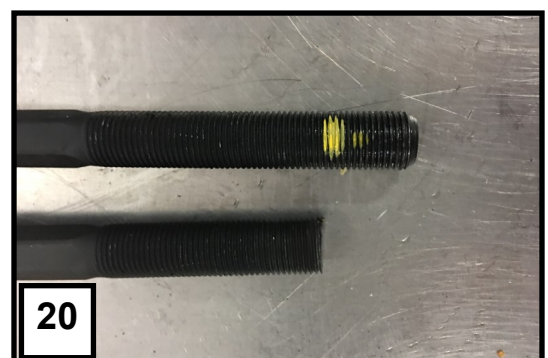
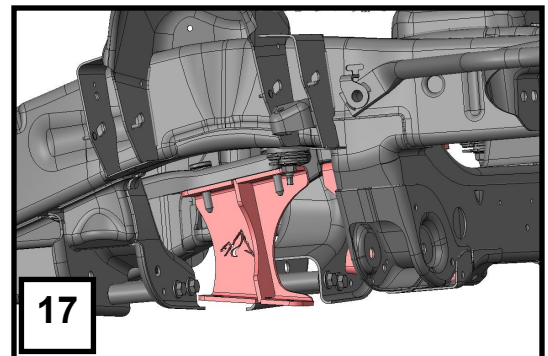
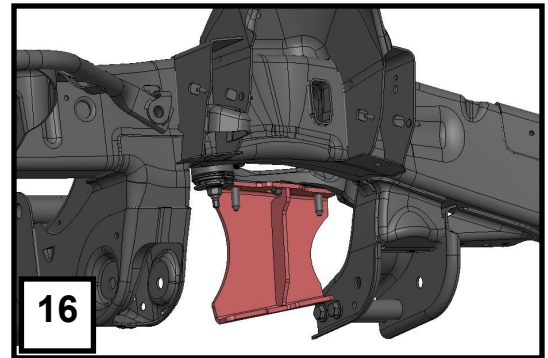

26. Remove the hub and brake backing plate from the factory spindle. Install on the lift spindle. **(PHOTO 21)**
27. Install the assembled lift spindle in the reverse order of the deinstallation, making sure the axle shaft does not pull out of its mounting point on the differential. Tighten the axle nut to 180ft-lbs.
28. Torque the upper and lower ball joints to 85 ft-lbs.
29. Reinstall the ABS harness, sensor, rotor and brake calipers using the OEM hardware in reverse process of deinstallation. Install the outer tie rod to the spindle using the supplied hardware. Torque to 65 ft-lbs.
30. Remove the brake line brackets by the top of the strut tower and install the brake line relocation brackets
31. Reconnect the sway bar end links back to the lower control arm and sway bar using factory hardware. Torque to 35 ft-lbs.

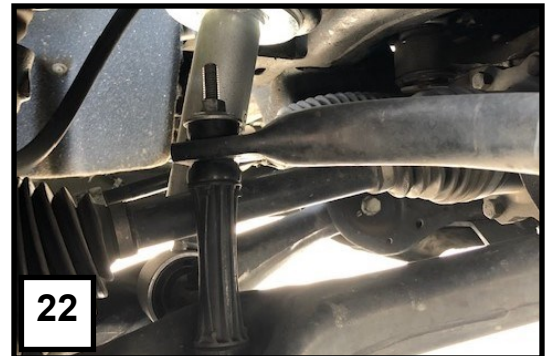

Install the skid plate using the supplied M12 hardware within the 150201F-777 kit and torque to 50 ft-lbs on the front crossmember, 30 ft-lbs on the rear crossmember. **(Photo 23)**



26. Using a 21mm socket remove the two nuts holding the crossmember located towards the center of the vehicle and install the rear compression arm bracket. The crossmember does not get removed so removing the bolts is not necessary. Factory hardware is retained. **(Photo 24)**

In some generations the frame has a flange that may need to be trimmed to further aid the compression arm install. (Figure 1)

26. Assemble the compression arms by pushing the supplied bushings into each end and pressing in the center tube found in 150201-100-HW bag.
27. Mount the compression arm brackets to the rear crossmember using the supplied hardware within the 150201E-777 packet. **(PHOTO 25)**

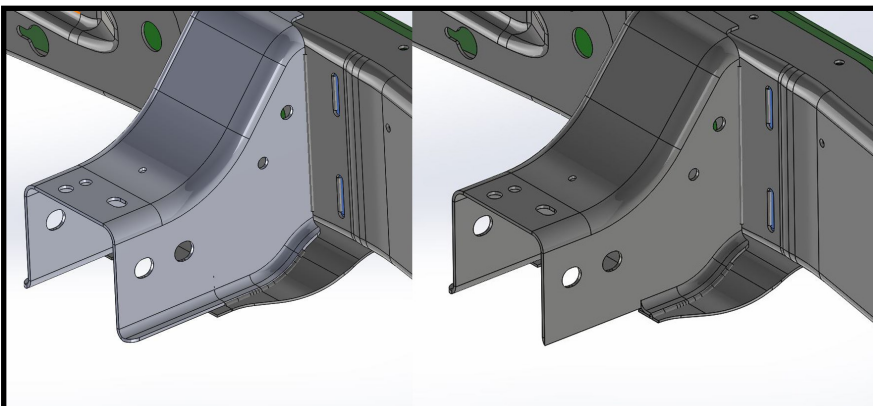
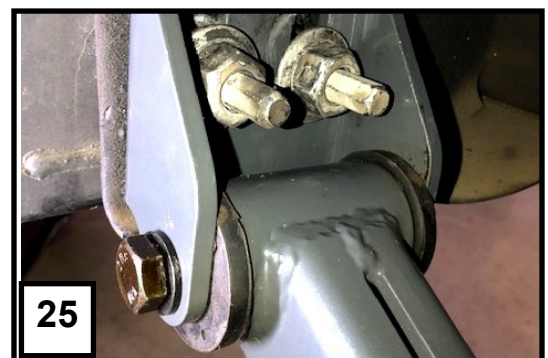

29. Swing the front of the compression arms up and attach them to the rear crossmember in similar manner to the rear of the arms. Torque to 60 ft-lbs. **(PHOTO 26)**
30. Mount the brake line to the upper control arm as shown using the front brake line relocation bracket and the supplied bolt within the 150201H-777 packet.
31. Install wheel and lower the front of the vehicle to the ground. The front installation is complete. Check that all hardware is torqued and installed properly.

REAR LIFT INSTALLATION

32. If not using a hoist, chock the front wheels to prevent the vehicle from moving while the rear end is lifted.
33. Jack up the rear of the vehicle from the differential.
34. Place jack stands under the frame rails and lower the vehicle onto the jack stands carefully.
35. Remove the wheels.
36. Remove the factory shock absorbers using a 21mm wrench & socket. The factory hardware will be reused. **(PHOTO 27)**
37. Remove the factory u-bolts and carrier plates by evenly undoing the nuts using a 21mm socket, then remove the factory blocks. Slowly lower the axle to allow for the new lift block to be installed. **(PHOTO 28)**
38. Install the block on the factory spring pad with the flat part of the block on the spring **and the tapered end towards the front.** Jack up the axle to meet the springs, making sure to align the center pin. **(PHOTO 29)**
39. With the floor jack applying slight pressure to the rear axle to keep the pin aligned, install the new supplied u-bolt hardware found within the 150201G-777 packet and tighten in a crossing pattern.
40. Locate the new shock absorbers, and install the shock absorbers in the factory mounting locations using the factory hardware. Tighten using a 21mm wrench & socket. **(PHOTO 30)**
41. Reattach the brake lines and harness wherever they were undone from their factory locations to create slack. Ensure that once reinstalled, none of the brake lines are being stretched before continuing.
42. Install the tires/wheels.
43. Jack up the vehicle to remove the jack stands. Remove the jack stands and lower the vehicle to the ground. The rear installation is now complete.

