



2006-07 GMC/Chevy Duramax
BD Remote Mount Exhaust Brake
 -- For 2500/3500 trucks equipped with LLY/LBZ Engines --

Part Number	Application
1024310	LLY/LBZ Duramax with 3.5" Stock Exhaust, Single Alternator
1024311	LLY/LBZ Duramax with 4.0" Aftermarket Exhaust, Single Alternator
1024310DA	LLY/LBZ Duramax with 3.5" Stock Exhaust, DUAL Alternators
1024311DA	LLY/LBZ Duramax with 4.0" Aftermarket Exhaust, DUAL Alternators

Serial # _____

Date Purchased _____

Purchased from _____

Installed by _____

***** Please read this manual before starting installation. *****

OWNER'S MANUAL - LEAVE IN GLOVE BOX

Install Manual Part # I1024310 – Printed in Canada

TABLE OF CONTENTS

Kit Contents..... 3

Welcome 4

Pre-Installation 4

Special Tools Required 4

Notes On Connectors..... 5

Brake Valve Installation..... 6

Solenoid Valve Installation 8

Air Supply..... 9

Main Wiring Harness Installation..... 10

Cruise Control 11

12 Volt Power..... 12

Vehicle Speed Input 12

Power Hook-up..... 14

Air Regulator & Air Compressor Install (Single Alternators)..... 15

Dual Alternator Air Compressor Installation 16

Main Switch Installation..... 18

Optional Shifter Switch (Push-Pull Style) 19

Optional Shifter Switch (Rocker Switch Style)..... 20

Wiring Diagrams..... 21

Brake Controller Calibration 23

Exhaust Brake Testing 24

Valve Maintenance..... 25

OPERATING GUIDELINES..... 26

LIMITED WARRANTY STATEMENT 28

Kit Contents

DURAMAX EXHAUST BRAKE BASE KIT

Every kit takes these components – specialty components on tables below.

Part #	Qty.	Description
1127038	1	Valve Assembly
1321018	1	Duramax LLY Control Kit
1220015	1	Pump control Kit
1220100	1	Air Brake snorkel kit
1100404	2	4.0" Marmon exhaust clamp

1024310 – Duramax 3.5" Stock Exhaust / Single Alternator

Part #	Qty.	Description
1100350	2	3.5" Exhaust pipe adapter
1100735	1	3.5" Exhaust seal clamp
1030118	1	Duramax compressor pump kit

1024311 – Duramax 4.0" Aftermarket Exhaust / Single Alternator

Part #	Qty.	Description
1100400	2	4.0" Exhaust pipe adapter
1100740	1	4.0" Exhaust seal clamp
1030118	1	Compressor / Regulator Kit

1024310DA - Duramax 3.5" Stock Exhaust / DUAL Alternators

Part #	Qty.	Description
1100350	2	3.5" Exhaust pipe adapter
1100735	1	3.5" Exhaust seal clamp
1030116	1	Compressor / Regulator Kit

1024311DA – Duramax 4.0" Aftermarket Exhaust / DUAL Alternators

Part #	Qty.	Description
1100400	2	4.0" Exhaust pipe adapter
1100740	1	4.0" Exhaust seal clamp
1030116	1	Compressor / Regulator Kit

BD Engine Brake Inc.

Plant Address: Unit A10, 33733 King Rd, Abbotsford, BC, Canada V2S 7M9

U.S. Shipping Address: 88-446 Harrison St, Sumas, WA 98295 U.S. Mailing Address: P.O. Box 231, Sumas, WA 98295

Phone: 604-853-6096 Fax: 604-853-8749 Internet: www.bd-power.com

Welcome

Thank you for purchasing a BD Engine Exhaust Brake. Your kit should have the items listed on the previous page for your installation. This manual is divided into different areas to assist you with your installation and operation of your braking unit. We strongly suggest that you write down the kit and serial numbers of your unit in the spaces provided and retain this manual for any future reference.

Pre-Installation

Before installation can begin, we must take a look at any other requirements or options for your particular application.

If the driver likes gauges, another handy option is the Brake Pressure Gauge Kit. This gauge will allow you to monitor the pressures being developed by the exhaust brake.

Special Tools Required

- Measuring tape or ruler
- Drill with 1/8" bit and Unibit
- Sawsall or hacksaw
- Crimping Pliers
- Test light

BD Engine Brake Inc.

Plant Address: Unit A10, 33733 King Rd, Abbotsford, BC, Canada V2S 7M9

U.S. Shipping Address: 88-446 Harrison St, Sumas, WA 98295 U.S. Mailing Address: P.O. Box 231, Sumas, WA 98295

Phone: 604-853-6096 Fax: 604-853-8749 Internet: www.bd-power.com

Notes On Connectors

The kit includes a number of Posi-Tap™ connectors (Gray or Red/Black/Green or Yellow) to tap onto OEM wiring. It is important to select the correct color of connector so that it matches the gauge of the OEM wire that it is being installed on. Using the incorrect connector could cause an inadequate connection and/or the OEM wire could be severed.

OEM Wire	Posi-Tap™ Color
18-22ga	Gray or Red
12-18ga	Black
10-12ga	Green or Yellow

Though these connectors offer a quicker installation, the best option would be to solder the wires and isolate the joints with heat shrink or liquid electrical tape. Proper soldering techniques should be used to ensure adequate connections.

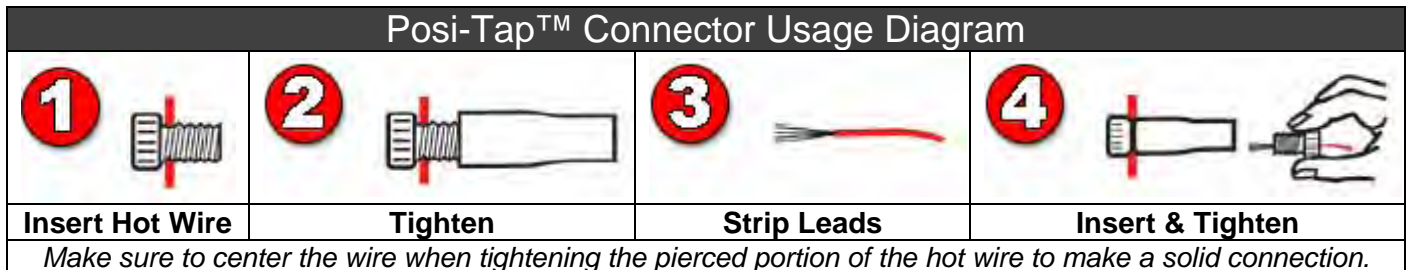

The ground terminals of the vehicle’s batteries should be disconnected before performing any piercing/posi-tapping onto any ECM/PCM wire.

Brake Valve Installation

From underneath the vehicle, locate a straight section of pipe at least 10" long – try and keep it as close to the engine as possible.

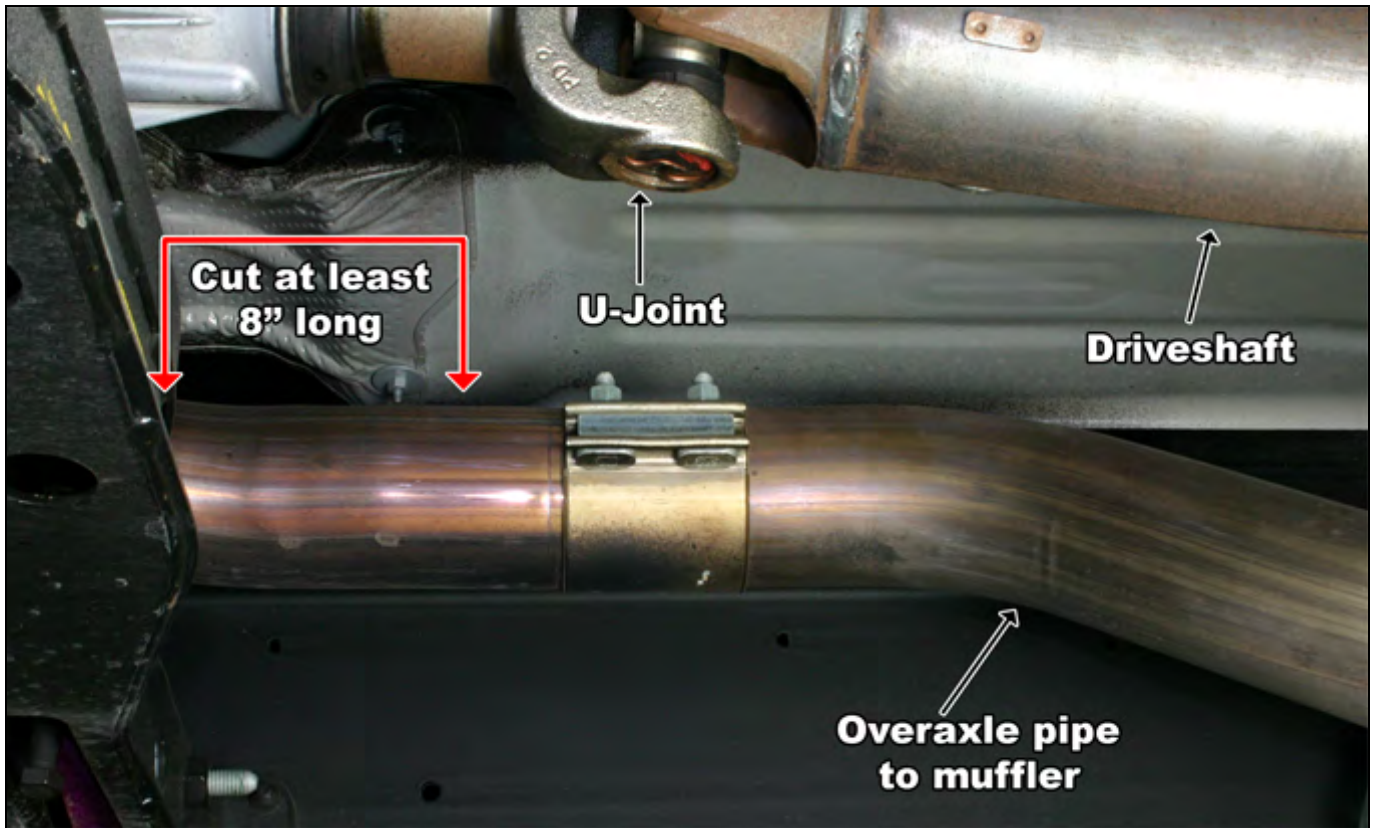

Remove the 8" section of pipe with a sawsall or cutoff saw.

Slide the supplied pipe adapter flanges over each side of the cut exhaust. The flange closest to the front of the vehicle will need to be welded. A good, clean weld is needed to seal the high backpressure that the exhaust brake will create. Mount the rear flange with the supplied stainless band clamp.

Insert the valve assembly in between the two flanges and ensure that there is ample room when welding and tightening the two flanges. There is a painted arrow cast into the exhaust brake indicating direction of exhaust flow. This arrow should be pointing **towards the rear of the vehicle**.

BD Engine Brake Inc.

Plant Address: Unit A10, 33733 King Rd, Abbotsford, BC, Canada V2S 7M9

U.S. Shipping Address: 88-446 Harrison St, Sumas, WA 98295 U.S. Mailing Address: P.O. Box 231, Sumas, WA 98295

Phone: 604-853-6096 Fax: 604-853-8749 Internet: www.bd-power.com

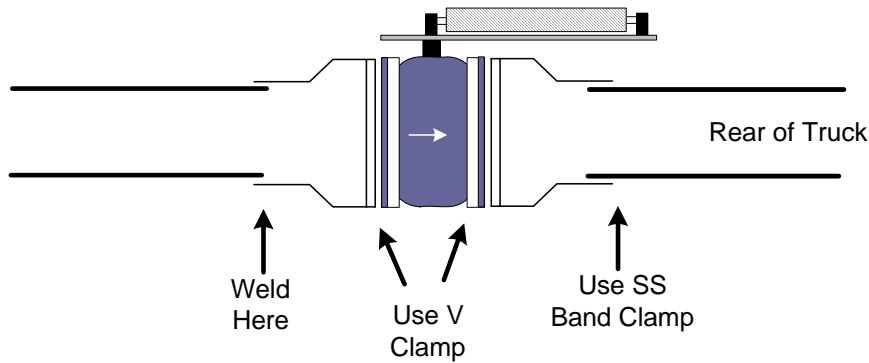

Once you have finalized the fit by welding the front flange and securing the rear the flange, tighten the two supplied V-band clamps around both flanges on either side of the exhaust brake. The exhaust brake should now be held securely in place.

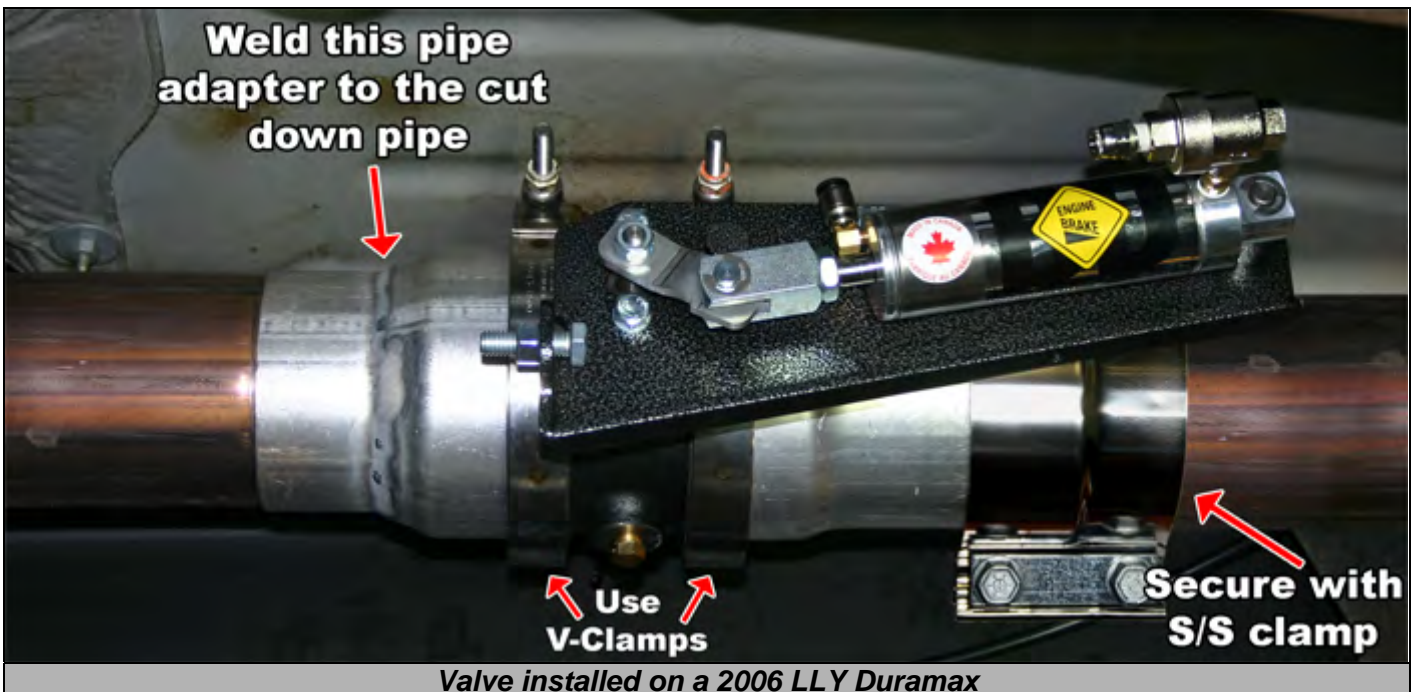

IMPORTANT NOTES ON VALVE INSTALLATION



THE VALVE ACTUATING CYLINDER MUST BE POSITIONED TO THE MIDDLE / INSIDE OF THE VEHICLE.

REMOVE THE BLACK SHIPPING CAP FROM THE RELEASE VALVE VENT OR THE BRAKE MAY STAY ENGAGED.

WHISTLING FROM THE EXHAUST BRAKE WHILE IT'S ON INDICATES AN IMPROPER V-BAND CLAMP ALIGNMENT.

Solenoid Valve Installation

The solenoid valve assembly controls the application of air pressure to the exhaust brake valve. There is no viable place to mount this assembly on the passenger side of the vehicle because of the exhaust system, so it must be mounted on the driver side. The solenoid valve should be mounted as *close as possible* to the exhaust brake so that it actuates quickly.



There is a wiring harness running along the outside of the driver's side frame rail and is secured with plastic clamps.

Locate one of the clamps closest to the rear transmission cross-member and pop the clamp mount out of the frame. This should leave a hole which is approximately 3/8" in diameter.



Using the hardware provided, mount the Solenoid Valve Assembly to the inside of the frame rail and re-install filter.

NOTE: Removal of the filter may necessary to install mounting bolt.

BD Engine Brake Inc.

Plant Address: Unit A10, 33733 King Rd, Abbotsford, BC, Canada V2S 7M9

U.S. Shipping Address: 88-446 Harrison St, Sumas, WA 98295 U.S. Mailing Address: P.O. Box 231, Sumas, WA 98295

Phone: 604-853-6096 Fax: 604-853-8749 Internet: www.bd-power.com

Air Supply

Insert one end of the ¼" plastic hose into the quick-connect coupler on the quick release valve on the brake air cylinder and route it over the drive shaft/transfer case to the 90° fitting on the solenoid valve.

Cut the hose with a knife or a hose cutter, leaving some slack for routing (do NOT use side cutting pliers as the hose will be squashed and leak). Ensure the end is cleaned of any burrs and insert the loose end into the 90° fitting on the solenoid valve.

An air vent snorkel kit is supplied in the brake kit which has a 14' section of ¼" plastic with a plastic yellow filter on one end. Insert the free end of the hose into the 90° fitting on the front of the brake air cylinder and route it over the drive shaft/transfer case.

Support these 2 hoses with the 4 plastic support clamps positioned in pairs using the self-tapping screws provided. You will have to drill a 1/8" pilot hole into the cross support for the clamp screws.



CARE MUST BE TAKEN NOT TO KINK THE PLASTIC HOSE OR ROUTE IT NEAR A HEAT SOURCE.

Insert one end of the remaining ¼" hose into the straight fitting of the solenoid valve and route this hose as well as the plastic hose with the yellow snorkel filter along the frame rail and into the engine compartment. The hose from the solenoid valve will later be attached to the regulator on the air compressor assembly when that is installed. The hose with the filter can be run through the firewall and secured under the dash area, away from any moving or heated equipment.

NOTE: To remove the plastic hose from the quick-connect coupler, push the outer colored ring toward the fitting and pull the hose out.

BD Engine Brake Inc.

Plant Address: Unit A10, 33733 King Rd, Abbotsford, BC, Canada V2S 7M9

U.S. Shipping Address: 88-446 Harrison St, Sumas, WA 98295 U.S. Mailing Address: P.O. Box 231, Sumas, WA 98295

Phone: 604-853-6096 Fax: 604-853-8749 Internet: www.bd-power.com

Main Wiring Harness Installation

To obtain access to the accelerator pedal and wiring harness, remove the dashboard bezel by pulling backward on the corners of the bezel.

Note: Placing the transmission all the way into 1st/low gear and ensuring the tilt steering is all the way down will allow for easier removal.

Remove the lower steering column panel by removing the mounting screws and unsnapping the panel from the instrument panel.

You will need to find a suitable mounting location for the electronic *LLY Brake controller*. Double sided tape or zap straps can be used to securely store the module out of harms way.

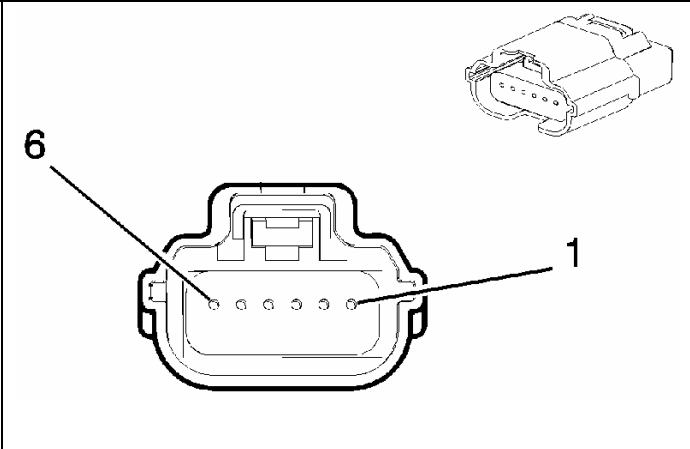
Accelerator Pedal Position Sensor (APPS)	
	 <p>6</p> <p>1</p>
<p>Pin 5 (APP Sensor 1 Signal)</p>	

At the throttle pedal, locate the **accelerator position pedal sensor (APPS)** plug and find the **dark blue** wire located at **pin 5**. Use the provided gray (or red) Posi-Tap connector to tap onto this wire. This wire should be routed to the TPS/APPS input of the brake controller module.

Cruise Control

You will need to remove the dash cover panel below the steering wheel. Once removed there is a steel shield that also needs to be removed to reach connector C201.

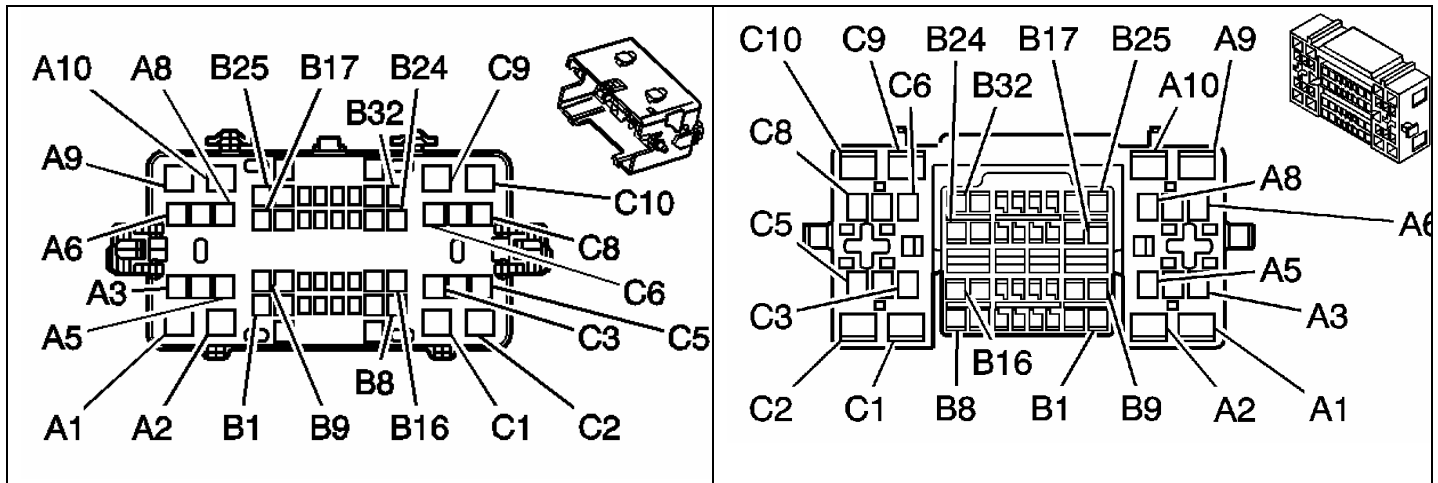
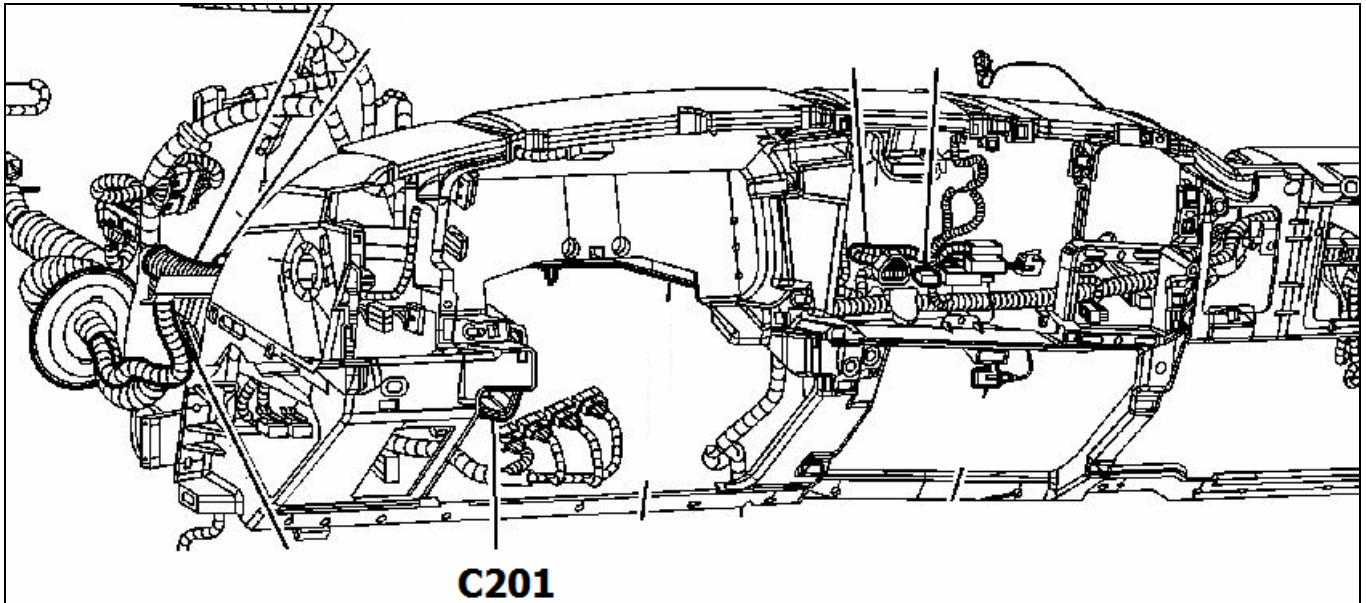

Pin	Color	Use
B31	Lt Green	
B32	Grey or GY/WHT	Cruise Wire
C9	Yellow	

Cut the **Cruise** wire (**Pin B32**) before the connector and strip ¼” insulation off of each end. Slip a piece of shrink tubing (supplied) over each end and up out of the way for now.

Insert one end of the cut wire into the Brake controller input marked **CRUISE IN** and the other cut end into the **CRUISE OUT** input. Extra wire has been provided complete the installation, and shrink tubing has been added to the kit to seal all connections.

Install the ground connection to the brake controller by selecting one of the mounting bolts or nuts that are fastened to the firewall. Be sure that it is a good solid clean ground.

12 Volt Power

Locate a switched power supply on the fuse panel (such as the example seen

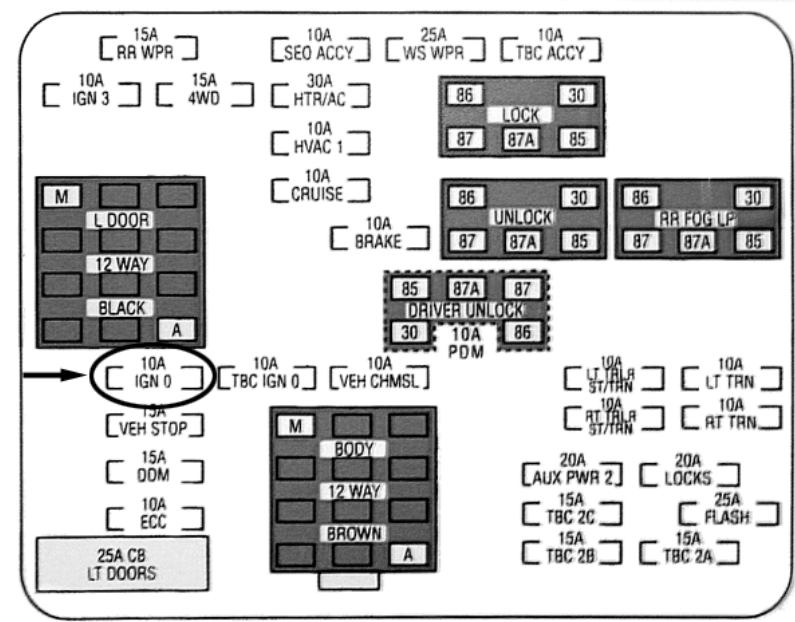

located in the diagram to the left) then install the brass fuse tap provided onto the HOT side of fuse which will be the side with power to it when the fuse is removed and key on.

Run the power wire from the exhaust brake toggle switch over to the fuse block and connect it to the installed fuse tap. Run this switched power source to the 12 Volt Power input on the brake controller module.

Master wiring diagrams are located on pages 21-22 if you require assistance.

Vehicle Speed Input

Due to the Duramax engine’s EGR being active during idle and low vehicle speeds, it is necessary to eliminate the brake activation during these conditions.

You will need to locate the **EBCM** (*Electronic Brake Controller Module*) on ABS equipped vehicles. The **EBCM** is mounted to the inside of the driver’s frame rail, just before the rear torsion bar adjustment for the front driver’s side suspension.

You will need to cut back some electrical tape and wiring loom to access the VSS wire. Once you have located the wire (**Yellow w/ black tracer**), attach the supplied

gray (or red) Posi-Tap and route the wire back up to the engine compartment through the firewall to the VSS INPUT of the brake controller module. This wiring can be routed along with the air lines. Please note that there are a number of yellow wires in this harness.

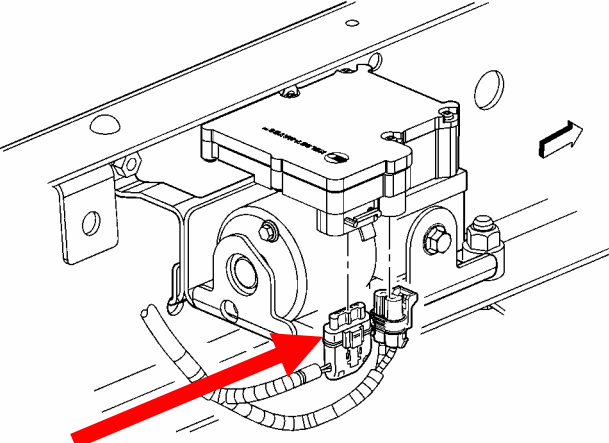
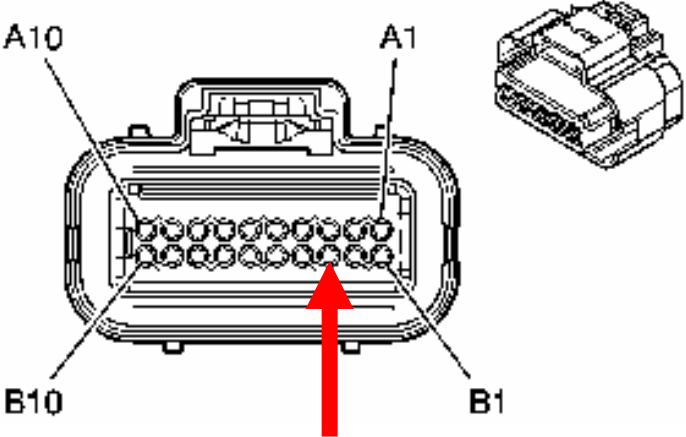
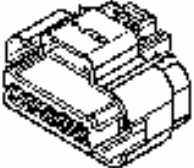
2004+ LLY	Location	Wire Color
Vehicle Speed Sensor Signal (VSS)	Pin B3 Connector 2	YEL/BLK
		

Power Hook-up

Open the red protective cover of the remote battery connection and you will see a nut and stud attached to the positive terminal.

Route the power wire segment from the air compressor assembly to this terminal. Attach the red connector to the positive terminal and secure with nut provided.

Locate the bolt on the power steering reservoir bracket to the left of the protective cover, and install ground wires.

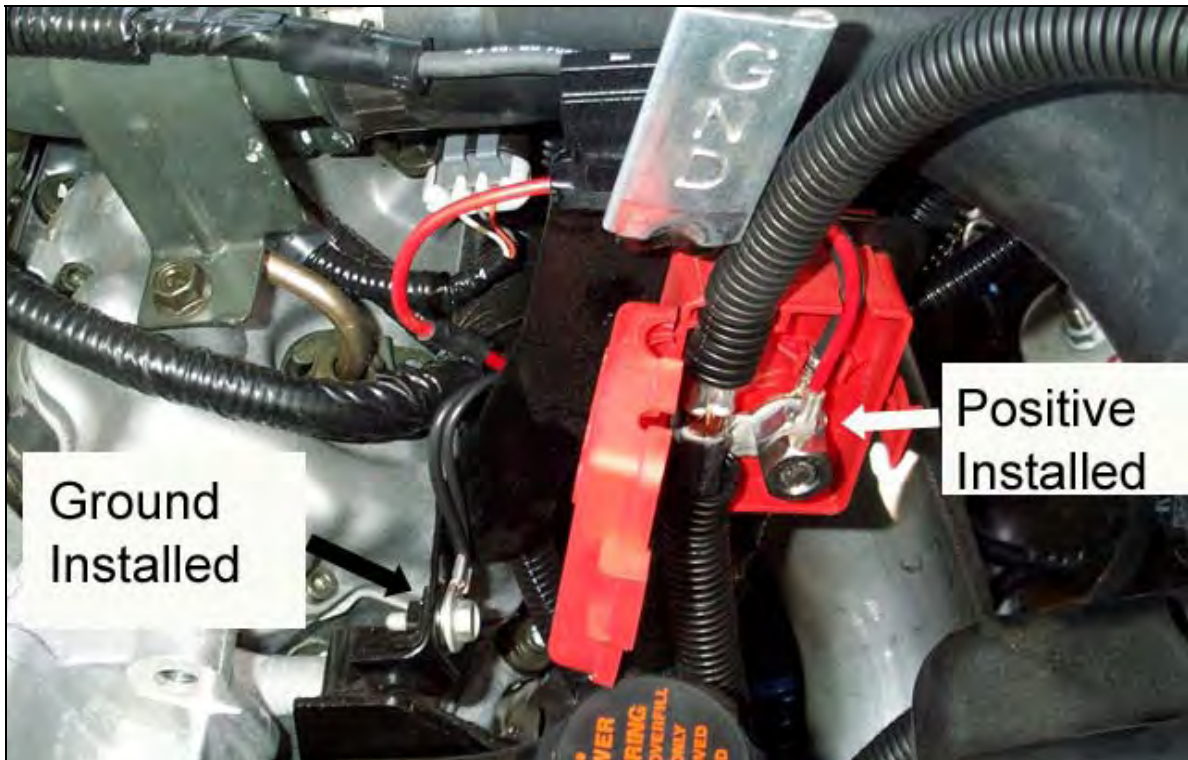

BD Engine Brake Inc.

Plant Address: Unit A10, 33733 King Rd, Abbotsford, BC, Canada V2S 7M9

U.S. Shipping Address: 88-446 Harrison St, Sumas, WA 98295 U.S. Mailing Address: P.O. Box 231, Sumas, WA 98295

Phone: 604-853-6096 Fax: 604-853-8749 Internet: www.bd-power.com

Air Regulator & Air Compressor Install (Single Alternators)



Locate a spot just to the left of the brake master cylinder assembly and install regulator & relay assembly. You may have to remove the relay and the relay socket holder to enable access to the mounting screw.



Locate a position by the air conditioner compressor to mount the pump assembly. There should be two open ended threaded bolt holes that will accommodate the two rear mounts of the air compressor nicely.

Install compressor and mount assembly into the position as displayed in the photos above.

Dual Alternator Air Compressor Installation

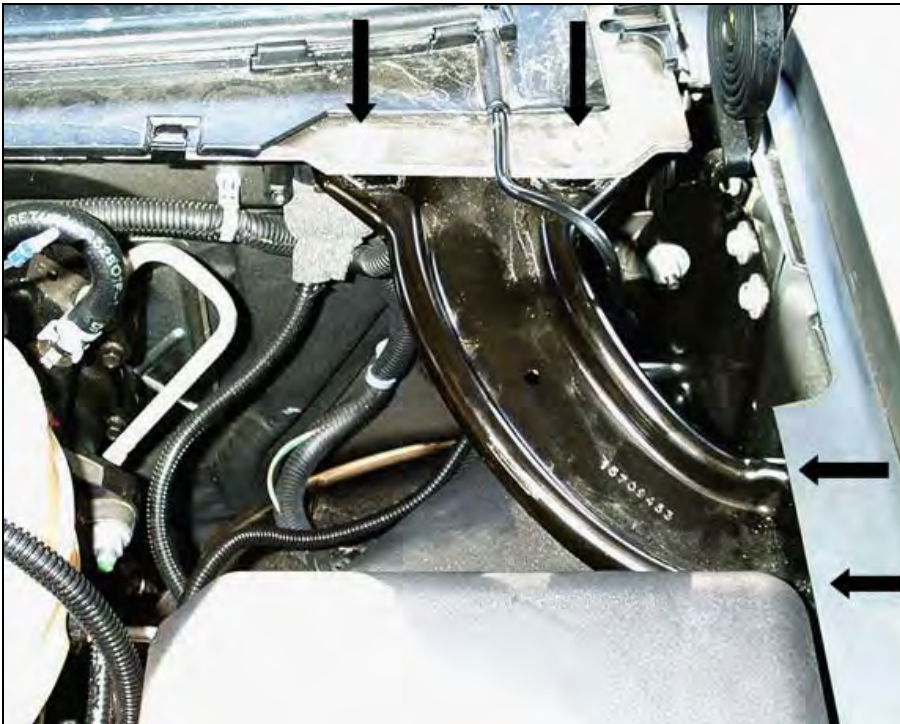

Locate the four (4) mounting bolts that secure the driver's side fender brace and remove them.



Push the black wire with the male bullet connector through the firewall grommet and connect it to the female bullet connector on the black wire coming from the brake controller module.

Secure any loose wiring under the dash with tie straps or electric tape and then re-install the lower kick panel.

Ensure the air compressor relay is mounted to the end of the mounting bracket before installation and install the grey filter supplied.

Connect the wiring harness from the cab to the compressor, Orange-to-Orange and Black-to-Black. Then install airline from solenoid to the fitting on the compressor.

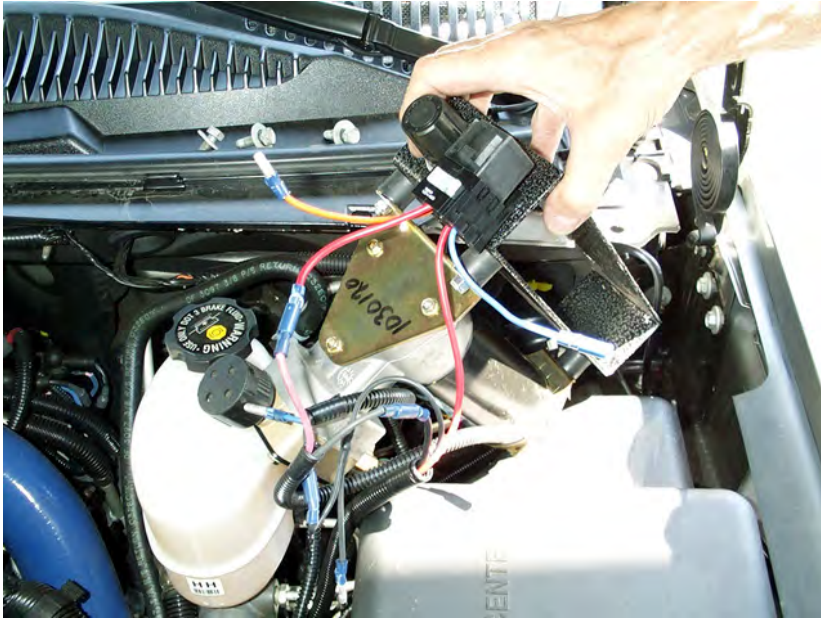

Position the air compressor assembly under the firewall flange into the cavity under the corner brace. Adjust the mount plate so that the upper 2 brace mounting bolts pass through the holes in the plate.

CAUTION: ENSURE WIRING AND HOSES ARE NOT PINCHED OR SQUASHED UNDER THE AIR COMPRESSOR WHEN INSTALLED.

Install fender brace and secure with 4 mounting bolts.

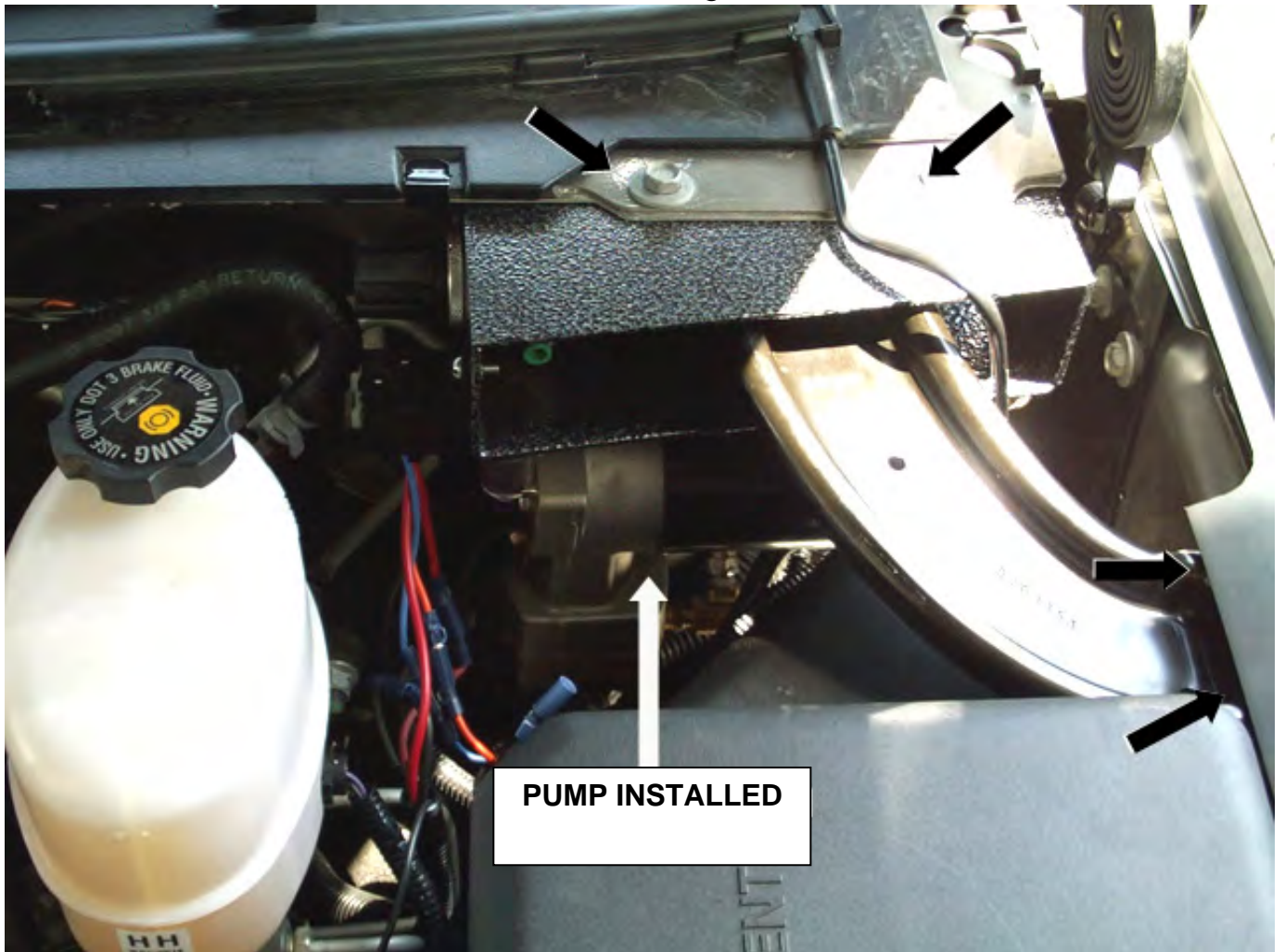

PUMP INSTALLED

Main Switch Installation

Measure and mark a spot for the toggle switch $1 \frac{5}{8}$ " up from the bottom edge of the dash panel and $1 \frac{5}{8}$ " in from the edge of the accessory panel as shown in the photo below. Drill a pilot hole with a $\frac{1}{8}$ ". Finish drilling the hole with a Unibit to exactly $\frac{1}{2}$ ".



Note: This measurement must be exact as possible to ensure room for the switch on the inside of the panel.

Install the toggle switch into the drilled hole and secure it with the black plastic lock ring. Attach the black ground wire to a good ground located on the firewall. Re-install the kick panel and dash bezel to finish the installation. Follow the wire diagram on page 21-22 to finish connecting the Brake controller to the toggle switch.

BD Engine Brake Inc.

Plant Address: Unit A10, 33733 King Rd, Abbotsford, BC, Canada V2S 7M9

U.S. Shipping Address: 88-446 Harrison St, Sumas, WA 98295 U.S. Mailing Address: P.O. Box 231, Sumas, WA 98295

Phone: 604-853-6096 Fax: 604-853-8749 Internet: www.bd-power.com

Optional Shifter Switch (Push-Pull Style)

Mount the shifter switch onto the shift lever using the clamp supplied (either 5/8" or 3/4"). Run the electrical cable down the shifter shaft, securing the cable with zip-ties or electrical tape, and run it under the carpet to the firewall and under the dash to the relays, leaving enough slack for proper shifting of the transmission lever and to prevent any rubbing of wire.

At the end of the cable, cut off any excess and strip away about 1 to 2 inches of the black rubber covering exposing the black and white (or green) wires then strip the insulation from the ends of the two wires.



Connect the white (or green) wire to the "Toggle Switch" terminal on the Duramax Brake Module.

Attach a male blade connector to the black wire. Remove the fused red wire from the toggle switch (the toggle switch and remaining red and black wire attached to the switch will no longer be needed) and attach to the black wire from the optional switch to the female connector of the fused Red wire from the toggle switch.

Locate one of the ignition switched red/black tracer wires under the steering column (one is 10/12ga and the other is 14/16ga) and connect an appropriate Posi-Tap connector to it (green or yellow for 10/12ga and black for the 14/16ga wire) then connect the fused red wire to this Posi-Tap.

BD Engine Brake Inc.

Plant Address: Unit A10, 33733 King Rd, Abbotsford, BC, Canada V2S 7M9

U.S. Shipping Address: 88-446 Harrison St, Sumas, WA 98295 U.S. Mailing Address: P.O. Box 231, Sumas, WA 98295

Phone: 604-853-6096 Fax: 604-853-8749 Internet: www.bd-power.com

Optional Shifter Switch (Rocker Switch Style)

Mount the shifter switch onto the shift lever using the clamp supplied (either 5/8" or 3/4"). Run the electrical cable down the shifter shaft, securing the cable with zip-ties or electrical tape, and run it under the carpet to the firewall and under the dash to the relays, leaving enough slack for proper shifting of the transmission lever and to prevent any rubbing of wire.

At the end of the cable, cut off any excess and strip away about 1-2" of the black rubber insulation exposing the black, white and green wires, then strip the insulation from the ends of the three wires.

Connect the green 12V output green wire to the "Toggle Switch" input terminal on the Duramax Brake Module.

Attach the 5/16" ring connector to the black ground wire and attach it to a good ground nearby.

Locate one of the ignition switched power fuses in the fuse panel underneath the steering column. Use the supplied fuse tap to supply ignition switched power to the "Keyed 12 Volts" (white) wire of the rocker switch assembly.

Also provided in the kit is a Posi-Tap connector as an alternative to the fuse tap and flag connector. If you want to use the Posi-Tap instead of using the fuse tap in the fuse panel, then you will need to locate a 12V switched ignition wire to power the switch. You could also use the 12V Switched Power source that powers the Duramax Brake Module.

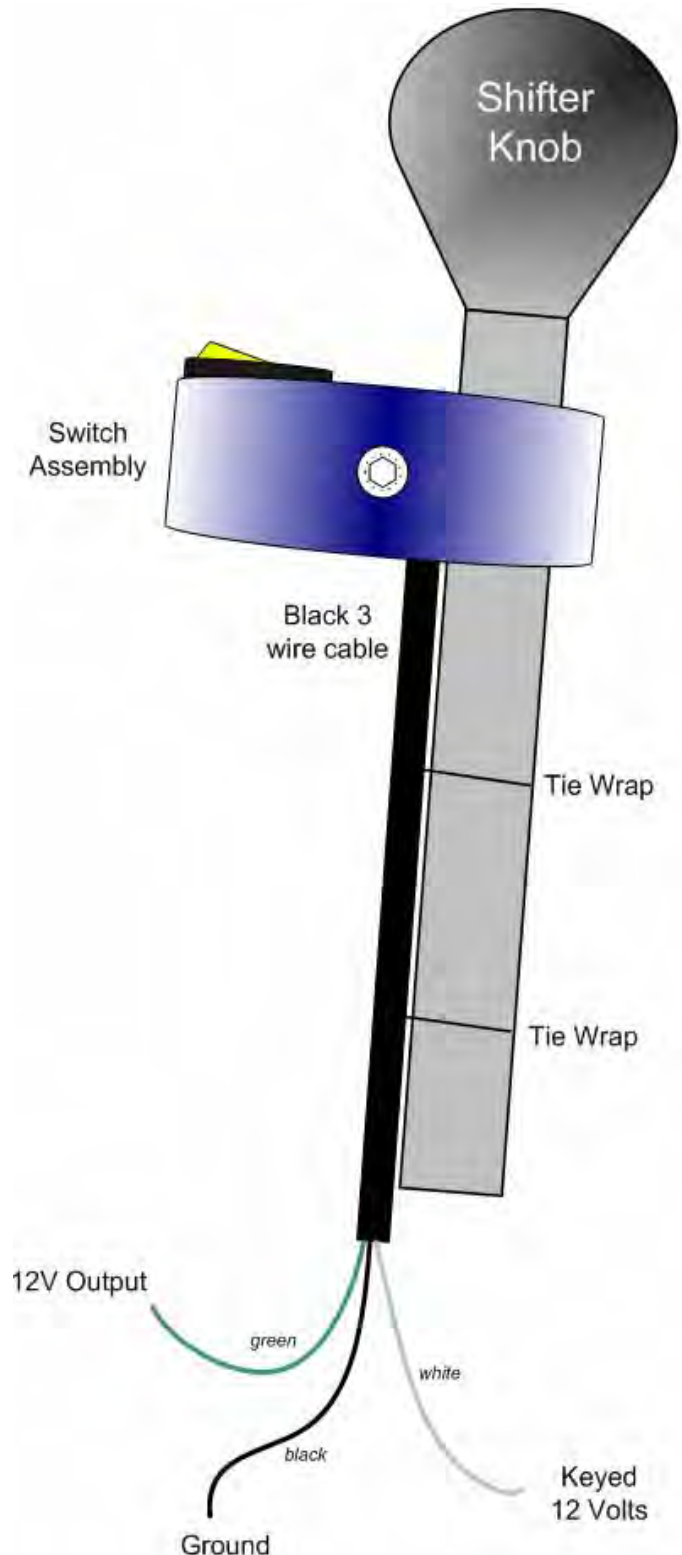

BD Engine Brake Inc.

Plant Address: Unit A10, 33733 King Rd, Abbotsford, BC, Canada V2S 7M9

U.S. Shipping Address: 88-446 Harrison St, Sumas, WA 98295 U.S. Mailing Address: P.O. Box 231, Sumas, WA 98295

Phone: 604-853-6096 Fax: 604-853-8749 Internet: www.bd-power.com

Wiring Diagrams

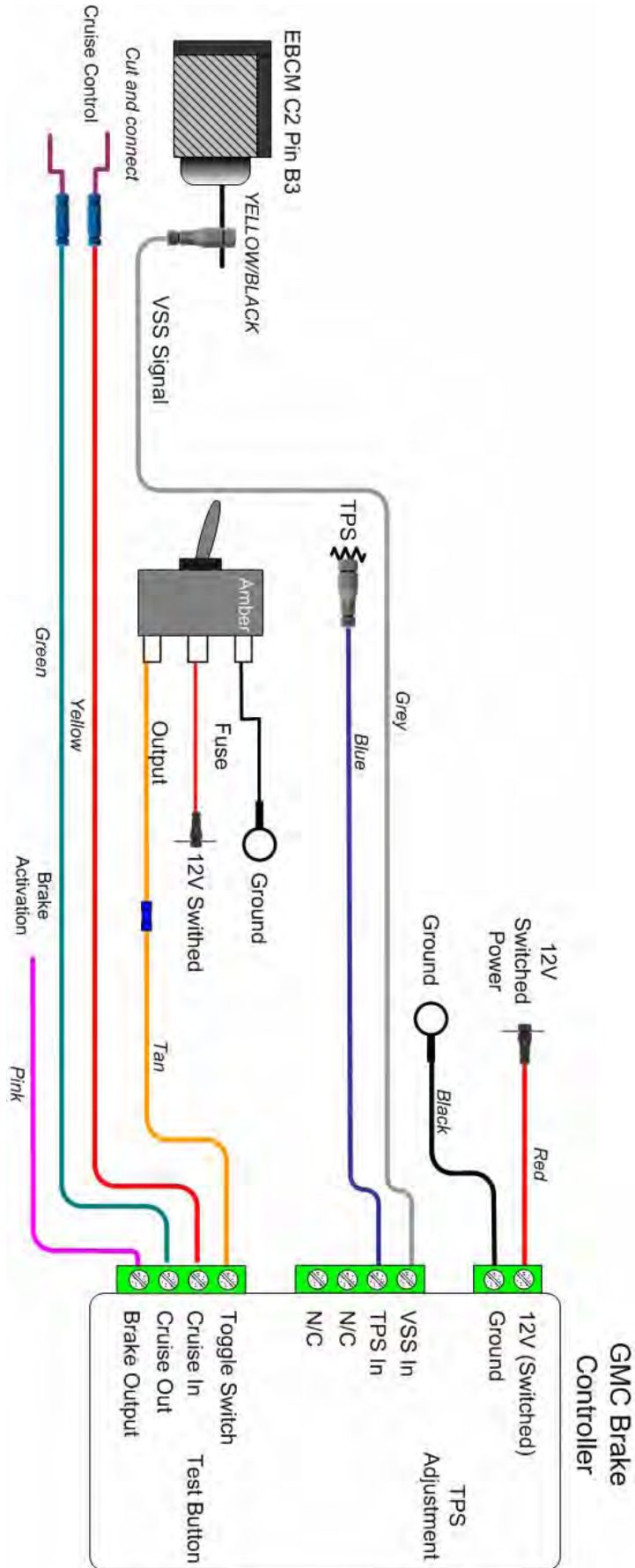

BD Engine Brake Inc.

Plant Address: Unit A10, 33733 King Rd, Abbotsford, BC, Canada V2S 7M9

U.S. Shipping Address: 88-446 Harrison St, Sumas, WA 98295 U.S. Mailing Address: P.O. Box 231, Sumas, WA 98295

Phone: 604-853-6096 Fax: 604-853-8749 Internet: www.bd-power.com

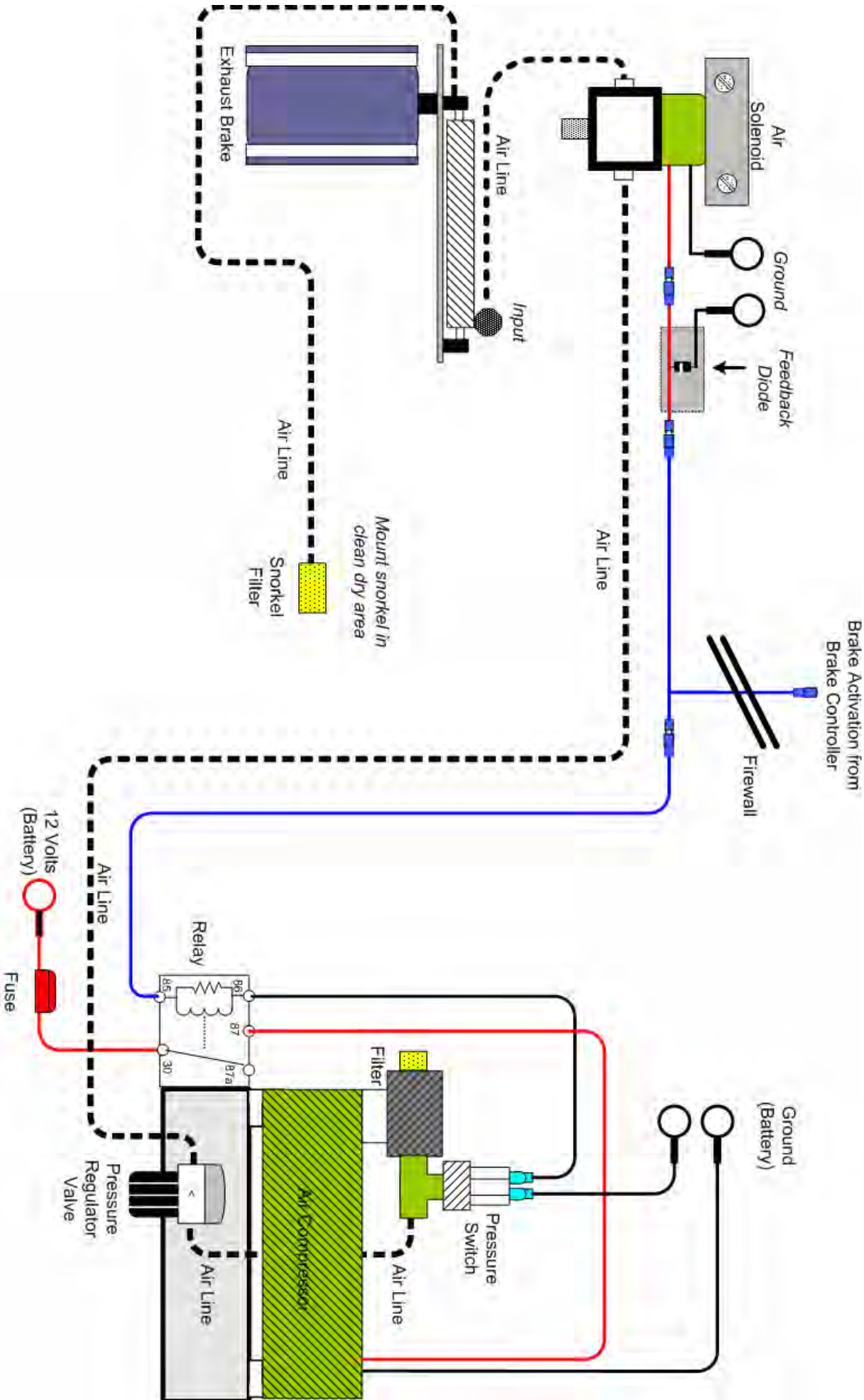

BD Engine Brake Inc.

Plant Address: Unit A10, 33733 King Rd, Abbotsford, BC, Canada V2S 7M9

U.S. Shipping Address: 88-446 Harrison St, Sumas, WA 98295 U.S. Mailing Address: P.O. Box 231, Sumas, WA 98295

Phone: 604-853-6096 Fax: 604-853-8749 Internet: www.bd-power.com

Brake Controller Calibration

Ensure the connections of the corresponding wires to the brake controller module are correct as shown in the wiring diagram.

To achieve the correct setting for the activation of the exhaust brake in relation to the throttle pedal, the brake controller module must be calibrated for your vehicle.

The brake controller has an LED inside of the case that should be visible through the semi-transparent case, which indicates brake activation.

Start the engine and while the truck is at idle, turn on the brake's toggle switch. Using a small flat bladed screwdriver, turn the small adjusting potentiometer on the bottom-right side of the brake controller module counterclockwise or clockwise until the brake engages and the LED JUST turns on.

You will need to hold the small test button on the side of the Brake controller during this process. This button must be pressed to calibrate the engagement / disengagement point of the exhaust brake, as normally the exhaust brake disengages at 15mph.

CAUTION: THE ADJUSTING SCREW IS A MICRO-SWITCH WHICH IS VERY DELICATE, SO TURN USING SMALL ADJUSTMENTS.

Test the new setting by revving the engine up to approximately 1000 RPM and releasing the throttle. As the accelerator pedal is applied, the test light should turn off just before the engine starts to rev, indicating proper calibration of the brake controller Module with the **TPS** (*Throttle Position Sensor*). Remember to keep the test button depressed while you are in this procedure.

The exhaust brake and LED should activate again when the throttle pedal returns to idle. If not, re-adjust the brake controller module so that it does. Once you completed this procedure, re-install the lower dash cover.



BD Engine Brake Inc.

Plant Address: Unit A10, 33733 King Rd, Abbotsford, BC, Canada V2S 7M9

U.S. Shipping Address: 88-446 Harrison St, Sumas, WA 98295 U.S. Mailing Address: P.O. Box 231, Sumas, WA 98295

Phone: 604-853-6096 Fax: 604-853-8749 Internet: www.bd-power.com

Exhaust Brake Testing

Start the vehicle and check for idle pressure.

The idle pressure of the exhaust brake should be 10–15 lbs. This is the preset from the factory so it should not need to be adjusted.

NOTE: The butterfly valve has been preset at the factory and should not need to be adjusted.

Start the vehicle and take it for a test drive. The brake will only engage above 15mph and will not operate below this speed. Take the vehicle above this set speed, turn on the brake activation switch and let off of the throttle. The brake should apply and you should feel the vehicle slow down. Once 15 mph is reached, the brake will disengage automatically. Accelerate past the threshold speed once more, and let off of the throttle once again. Re-apply the throttle and make sure that the brake **quickly** disengages.

The brake must quickly disengage, if it does not, a PCM error code maybe generated. Some common reasons for a slow reacting brake would be: the brake controller being out of adjustment or the air solenoid valve may be too far away from the brake.

Next you will need to test the brake for maximum retarding pressure. You can either do this under load from a large hill or perhaps from letting off the throttle at a high RPM.

The regulated pressure is adjusted with the regulator on the control assembly and has been preset to allow a MAXIMUM of 55psi of exhaust back pressure. Note that you should try to attain this maximum pressure.

CAUTION: Do NOT exceed 55psi of backpressure.

If you cannot reach the maximum desired pressure, firstly check for leaks in all exhaust flanges and welded areas, as this is the most common area for leaks. If no leaks are found, you may turn the pressure regulator clockwise ½ turn for more pressure. If your pressure is too high, turn the pressure regulator counter clockwise to reduce the back pressure.

While driving, turn the cruise control on, and then try to activate the brake. The activation of the brake should disable the cruise control. Turn the brake off and activate cruise again, this time pressing down on the hydraulic brake pedal to ensure cruise control disconnects when the brake pedal is applied.

BD Engine Brake Inc.

Plant Address: Unit A10, 33733 King Rd, Abbotsford, BC, Canada V2S 7M9

U.S. Shipping Address: 88-446 Harrison St, Sumas, WA 98295 U.S. Mailing Address: P.O. Box 231, Sumas, WA 98295

Phone: 604-853-6096 Fax: 604-853-8749 Internet: www.bd-power.com

You may also notice that every time the vehicle is started the exhaust brake is cycled for a 1/10th of second. This should help everything stay free and clean and also reduce the possibility of the valve being contaminated.

NOTE: Over the next two weeks, the backpressure at idle may rise due to initial carbon build up and the brake valve will need to be adjusted again.

Check for any exhaust leaks and recheck all connections and hoses for security and interference from moving or heated items. After about 100 miles (160 km), re-torque the turbo exhaust clamp and flange bolts.

Valve Maintenance

To extend the life of the valve assembly, do not operate vehicle for an extended periods of time without activating the exhaust brake. We suggest activating the brake at least a couple times on any day you operate the vehicle to prevent any carbon or rust build-up on the inner components of the valve assembly.

The hoses, wires, fittings and clamps should be inspected on a regular basis for any deterioration, damage or leaks.

Following the diagrams in this manual, tracing hoses and wiring, checking continuity through electric components or checking for any lines that are disconnected, should solve any problems that may arise. If you have any problems or need replacement parts, call us at 1-800-887-5030, between 8:30am and 4:30pm Pacific Time.

FOR MAXIMUM EFFICIENCY USE TRANSMISSION IN TOWING MODE

BD Engine Brake Inc.

Plant Address: Unit A10, 33733 King Rd, Abbotsford, BC, Canada V2S 7M9

U.S. Shipping Address: 88-446 Harrison St, Sumas, WA 98295 U.S. Mailing Address: P.O. Box 231, Sumas, WA 98295

Phone: 604-853-6096 Fax: 604-853-8749 Internet: www.bd-power.com

OPERATING GUIDELINES

Thank you for taking interest in the BD Engine Exhaust Brake. As a driver, you probably already know the need for extra braking power that your vehicle requires on the hills and long grades. With loads being towed behind you, the extra push when slowing down or maintaining speed on downward grades can prove to be a great strain on your vehicles hydraulic braking system, even to the point of “burn-up”. These guidelines were designed to offer you a better understanding of the benefits of exhaust brakes and are partly based upon material developed by the U.S. Department of Transportation National Highway Traffic Safety Administration.

The emphasis on today’s vehicles is to give the consumer a product that can give them usable power with fuel efficiency. But, in the transition, the vehicles have lost their natural braking power, making it more easy for the vehicle to continue to roll and harder to stop. Of course, this gets more noticeable with the increase of weight, on or behind the vehicle. This is where an exhaust brake becomes a useful tool in increasing the driveline drag of the vehicle without the use of the hydraulic brakes. It is a tool that with maximum use, or even occasional use, can reduce wear on hydraulic braking parts and at the same time increase safety.

The BD Exhaust Brake can be used to help maintain a controlled vehicle speed on a downward grade, as well as slowing the vehicle down for such times as turns or exit ramps, without you using your hydraulic brakes. **But, the exhaust brake cannot be used as a parking brake or will not bring your vehicle to a complete stop.** By using a BD Exhaust Brake, the life and effectiveness of your hydraulic brakes will increase.

This is because of the decreased use of the hydraulic brakes in situations like hills, the wear factor is reduced and there is less opportunity for your hydraulic brakes to heat up which would reduce the efficiency. When you ride your hydraulic brakes, make hard stops or have poorly adjusted brakes, this creates high temperatures and as your brakes get hotter, the more chance there is for fade or failure.

With terrain that is a series of up and down grades, the BD Exhaust Brake will aid in reducing exhaust valve warpage. Because of the power needed to pull your vehicle and load up a hill, this generates a lot of heat. When you have reached the crest of the hill and are now coasting down the other side, the heated valves are too quickly cooled. With the exhaust brake engaged, the heat loss to the valves will be reduced, which can prevent valve warpage.

When the toggle switch is turned to the “On” position, the valve is activated every time the driver takes his foot off of the throttle pedal. When the driver puts pressure back on the throttle pedal, the throttle switch (or electronic brake module) is deactivated and the valve opens again. Exhaust brakes are designed to operate with the throttle at idle, not to be used in conjunction with cruise controls, and not

BD Engine Brake Inc.

Plant Address: Unit A10, 33733 King Rd, Abbotsford, BC, Canada V2S 7M9

U.S. Shipping Address: 88-446 Harrison St, Sumas, WA 98295 U.S. Mailing Address: P.O. Box 231, Sumas, WA 98295

Phone: 604-853-6096 Fax: 604-853-8749 Internet: www.bd-power.com

designed to aid in gear shifting. Such cases could cause damage to engine and/or the exhaust brake.

The best scenario for exhaust braking is when going down hill, select a gear that lets you maintain a constant speed with little or no use of the hydraulic brakes, or the same gear that would be used to go up the same grade of hill. This also depends on the weight, load or road conditions that the vehicle will come upon.

So, in summary, by using the BD Exhaust Brake, you reduce the need for use of your hydraulic brakes in situations where you need to slow down or maintain (i.e. hills, off ramps, corners, approaching speed changes or traffic lights). Reducing the use of your hydraulic brakes in these situations will reduce the heat build up, as well as wear and damage to linings and drums.

And, when you reduce these factors, you save your hydraulic brakes for when you really need them (for stopping or emergencies).

The BD Exhaust Brake is not a substitute for your hydraulic brakes and, cannot correct or compensate for poorly maintained or misadjusted brakes. But, when you need to slow down or maintain a constant speed, the BD Exhaust Brake will be a valuable and effective tool. Exhaust Brakes are more efficient at preventing than correcting an over speed condition.

Thank you and happy motoring.

BD Engine Brake, Inc.

BD Engine Brake Inc.

Plant Address: Unit A10, 33733 King Rd, Abbotsford, BC, Canada V2S 7M9

U.S. Shipping Address: 88-446 Harrison St, Sumas, WA 98295 U.S. Mailing Address: P.O. Box 231, Sumas, WA 98295

Phone: 604-853-6096 Fax: 604-853-8749 Internet: www.bd-power.com

BD ENGINE BRAKE, INC.
LIMITED WARRANTY STATEMENT

BD Engine Brake, Inc. (BD) warrants to the original purchaser that any parts purchased shall be free from defects in material workmanship. A defect is defined as a condition that would render the product inoperable. BD limits the liability to the repair or replacement, at BD's option, of any warrantable product, returned prepaid with a complete service history and proof of purchase to the factory. A valid proof of purchase is a dated bill of sale. Repaired or replaced product will be returned to the customer freight collect. Accepted warranty units, which have been replaced, become the sole property of BD.

A Return Authorization (WA) number obtained in advance from a BD customer service representative must accompany product returned for warranty determination. BD will be the final authority on all warranty decisions.

This warranty shall not apply to any unit that has been improperly stored or installed; or to misapplication, improper operation conditions, accidents, or neglect, or which has been improperly repaired or altered or otherwise mistreated by the owner or his agent.

This parts warranty shall terminate at the end of 24 months in service with the original user. Labor costs incurred by the removal and replacement of the BD product, while performing warranty work, will be covered for 12 months at authorized centers with prior approval. Until the claim has been approved by BD, the consumer may be responsible for these costs.

Except as set forth in our parts outline, BD disclaims any implied warranties of merchantability and fitness for a particular purpose. **BD also disclaims any liability for incidental or consequential damages including but not limited to, repair labor, rental vehicles, hotel cost or any other inconvenience costs.** This warranty is in lieu of all other warranties or guaranties, either expressed or implied, and shall not extend to any consumer or to any person other than the original purchaser residing within the boundaries of the continental U.S. or Canada.

BD Engine Brake Inc.

Plant Address: Unit A10, 33733 King Rd, Abbotsford, BC, Canada V2S 7M9

U.S. Shipping Address: 88-446 Harrison St, Sumas, WA 98295 U.S. Mailing Address: P.O. Box 231, Sumas, WA 98295

Phone: 604-853-6096 Fax: 604-853-8749 Internet: www.bd-power.com