



Ford 6.0L AutoLoc

Installation Instructions

Part# 1031300

PLEASE READ ALL INSTRUCTIONS BEFORE INSTALLATION.

Cautionary Note:
Please read the disclaimer before proceeding to install this unit.

Installation Manual P/N# I1031300
Printed in Canada

Welcome

The new Ford 6.0L AutoLoc is a revolutionary new product from BD Engine Brake. Not only does it have the ability to control torque converter clutch lockup while decelerating, but it also has the ability to increase main line pressure in the Torqshift transmission. All these functions compliment the use of the BD Exhaust Brake and your Ford Powerstroke.

For this installation, you will need a transmission pressure gauge capable of displaying up to 300psi.

Installation

1. Disconnect both battery cables on both batteries (ground first) using an 8 mm wrench.
2. Remove the driver's side battery cover by releasing the tab located on the left side (towards the front of the vehicle) of the battery cover. You may need to use a screwdriver to pry the tab apart.
3. You will need to disconnect both the first (smallest) connector and the middle connector of the PCM. It is suggested that you work them free to allow yourself some room for better access.

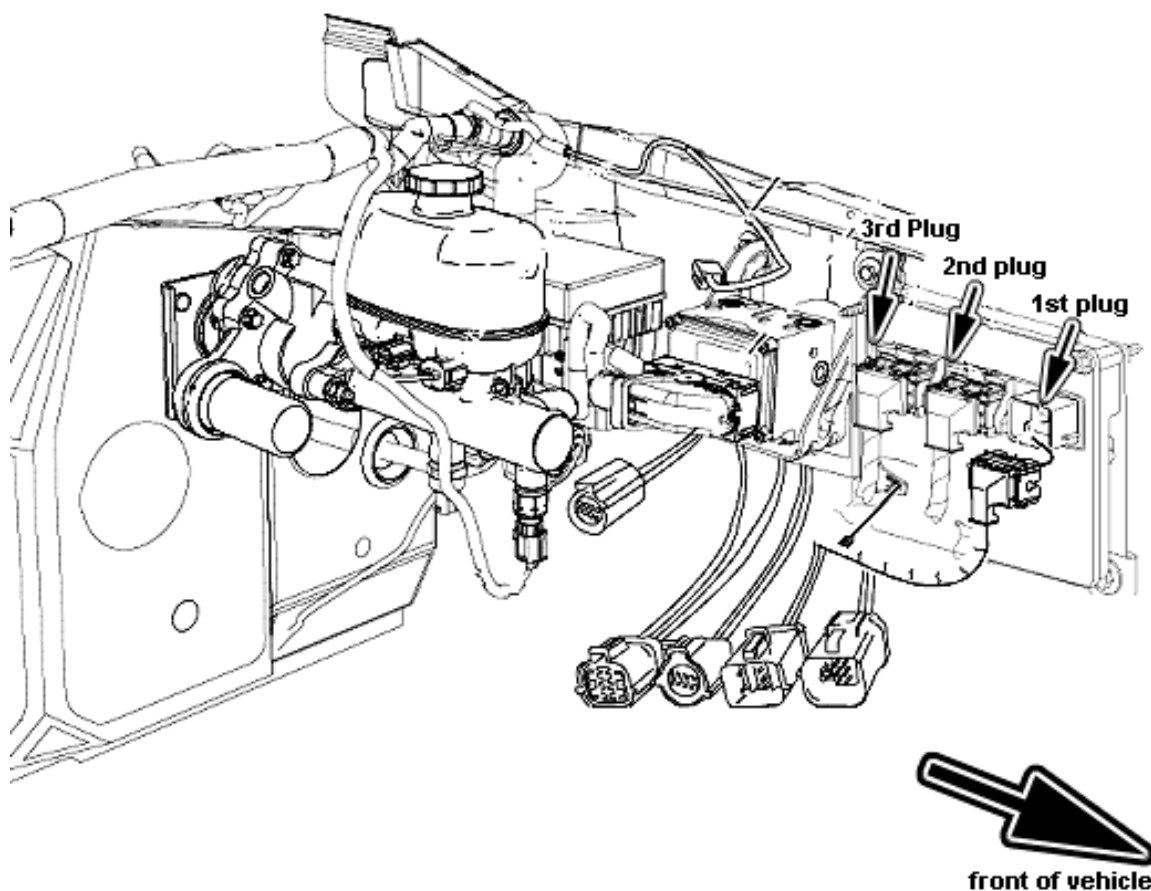

BD Engine Brake Inc.

Plant Address: Unit A10, 33733 King Rd, Abbotsford, BC, Canada V2S 7M9

U.S. Shipping Address: 88-446 Harrison St, Sumas, WA 98295 U.S. Mailing Address: P.O. Box 231, Sumas, WA 98295

Phone: 604-853-6096 Fax: 604-853-8749 Internet: www.bd-power.com

4. On the first connector (smallest) locate the PCS (pressure control) solenoid wire (see table and diagram). You will need to cut this wire and attach a blue Posi-Lock connector.
5. Still on the first (smallest) connector, locate the **TCC control wire** (see table and diagram). Also cut this wire and attach a blue Posi-Lock.

1 st Connector	Ford PCM Pin	Wire Color
PCS	2	Violet/Yellow
TCC	14	Brown/Orange

6. You will now need to connect the PCS wires to the AutoLoc wiring harness. The cut **PCS** wire on the PCM side should be connected to **tan** wire in the AutoLoc harness. This tan wire will be connected to pin 5 of the AutoLoc at the factory. These connections should be made using the supplied blue Posi-Lock connectors. Reference to the wiring diagram on page 9 for more information.

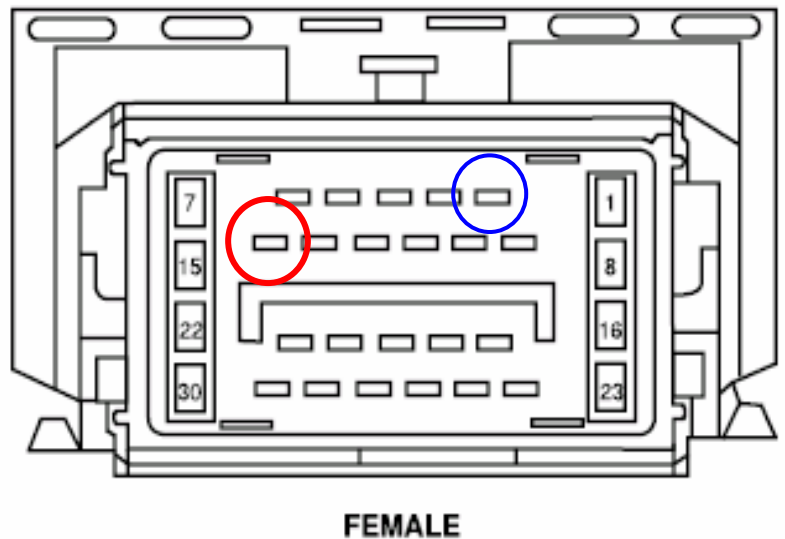

7. The other side of the cut **PCS** wire (leading to the transmission) should then be connected to the **blue** wire of the AutoLoc harness. This blue wire will be connected to pin 8 of the AutoLoc at the factory.
8. Connect the cut **TCC** wires to the AutoLoc. The cut **TCC** wire closest to the PCM should be connected using the supplied blue Posi-Lock connector to **green** wire of the AutoLoc. This green wire will be connected to the AutoLoc connector at the factory to pin 6.
9. Connect the other side of the **TCC** wire (leading to the transmission) to the violet wire of the AutoLoc harness. This **violet** wire will be connected to pin 7 of the AutoLoc at the harness.
10. Re-connect the first factory PCM plug to the Ford PCM.
11. On the third (end) plug you will need to locate the tachometer output wire.

3rd Connector	Ford PCM Pin	Wire Color
Tachometer Output	1	Light Green/White

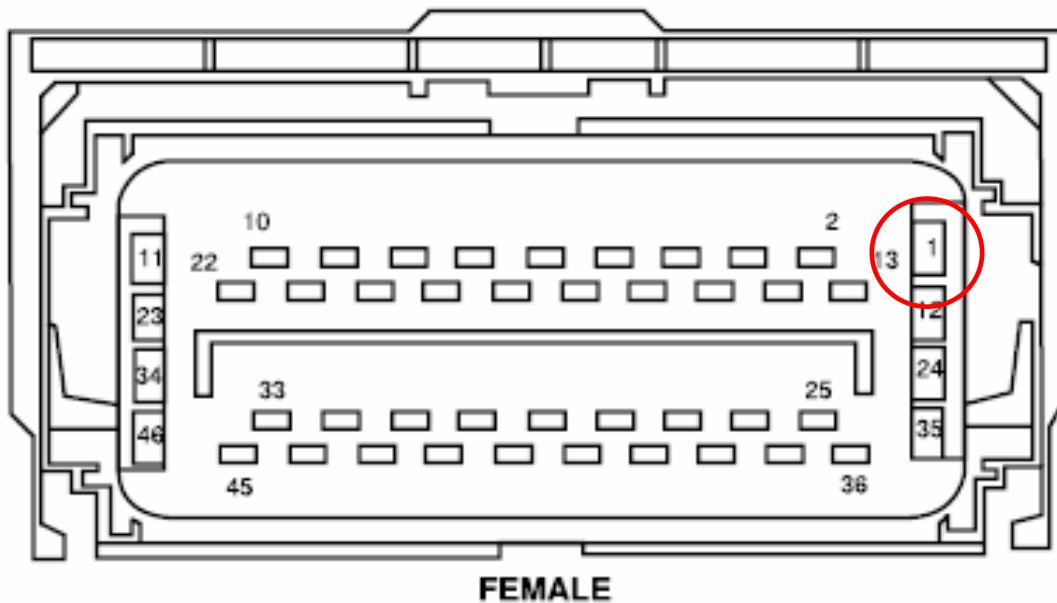

12. Install the supplied gray Posi-Tap connector to the tachometer output wire. You will need to connect the **pink** wire of the AutoLoc harness to this Posi-Tap. The pink wire should be connected to pin #3 of the AutoLoc.
13. You can now reconnect the third (end) PCM connector to the Ford PCM.
14. You will now need to connect the yellow wire from the AutoLoc harness to the brake activation circuit. This circuit is what activates the exhaust brake on and off. (12V – 0V) You can locate this from the output of the 6.0L Exhaust brake controller as it travels across the firewall over to the passenger side of the vehicle. This wire should be also yellow in color. Apply the supplied Posi-Tap connector to connect the two wires together. This wire should be connected to pin # 10 of the AutoLoc.
15. You can now connect the black ground connection the driver's side negative battery terminal. Use an 8mm socket to install the o-ring connector.
16. Connect the red power wire to a 12 volt **switched** power source. You can locate this power source in the fuse panel directly under the steering wheel. You will need to route this red power wire through the firewall into the cab to the fuse box. Locate fuse number F2.29 (10A). The left side is the fused side. Use the supplied fuse tapper and female blade connector to make this

connection.

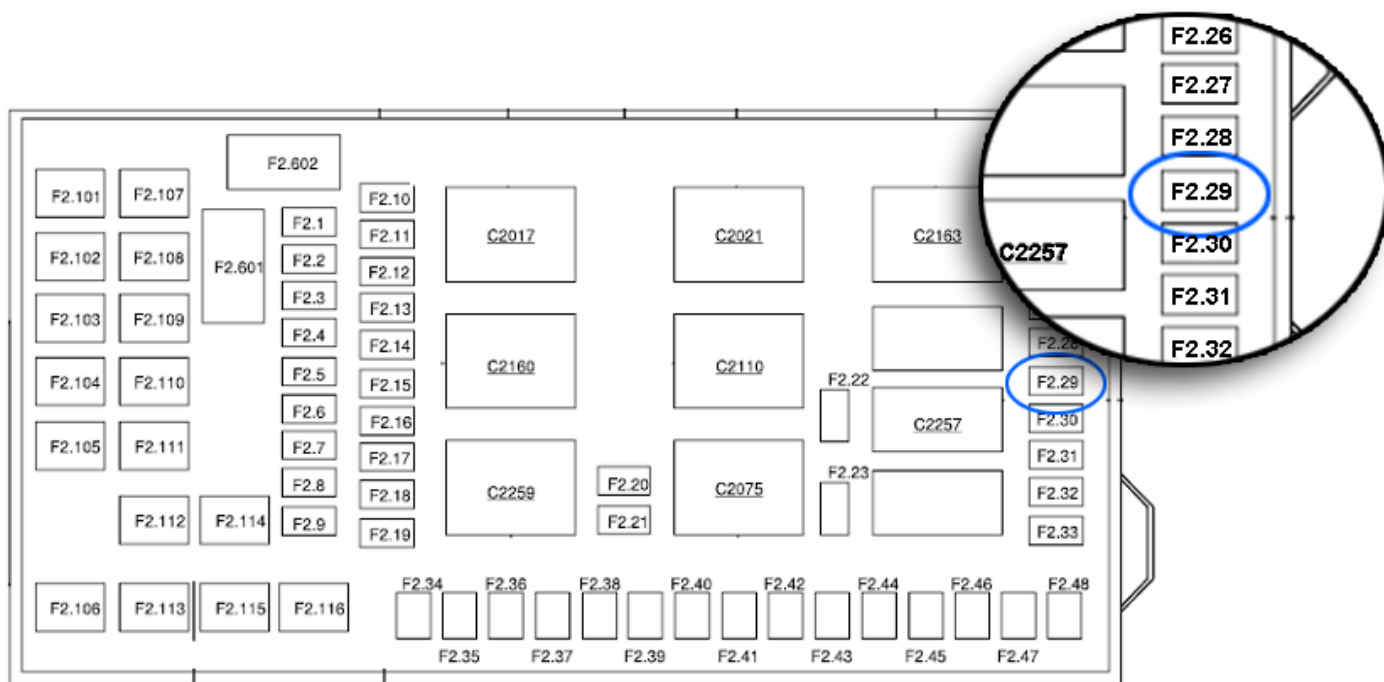

17. Connect the AutoLoc wiring harness to the AutoLoc unit and install it in the driver's side rear corner. Zip ties and Velcro have been included in the kit to mount the unit.
18. You may now reconnect all the battery connections and prepare for a test drive.

AutoLoc Adjustments

19. You will need to re-check the default settings in the AutoLoc unit before driving. To do this, you will need to use a flat screwdriver to unlock the unit from the locking tabs. There are two locking tabs located on the side of the enclosure.
20. Once the unit is open, you will notice the three potentiometers on the right hand side of the AutoLoc board. Disregard the potentiometer labeled "VSS", as it is a function not currently used in this kit. Note the default potentiometer settings, as they may need to be adjusted slightly.

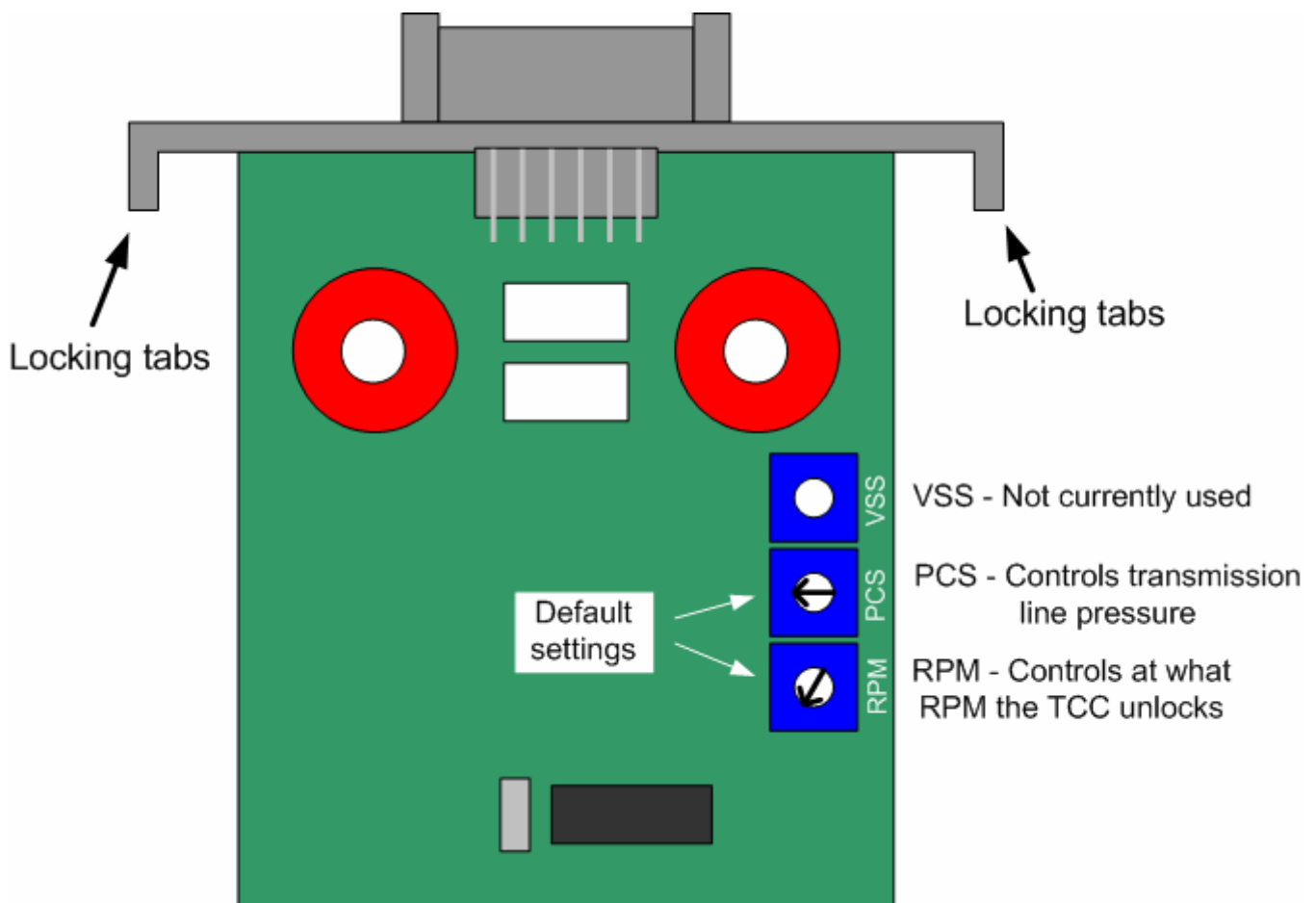

21. Starting with **version 2** AutoLoc modules, there is a jumper on the circuit board (see picture to the right). This setting is to tell the AutoLoc module whether an E-Series or an F-Series vehicle is being used, and will adjust the programming settings accordingly.

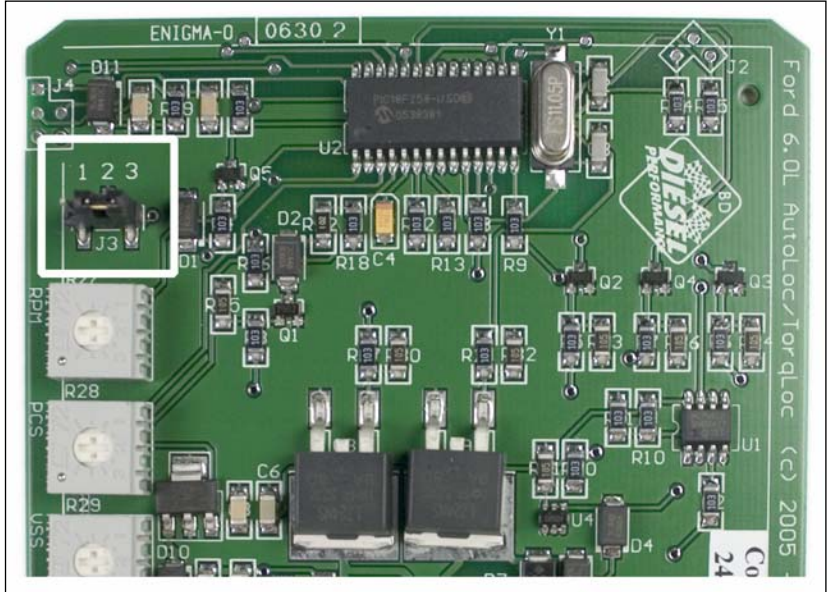

The settings are as follows:

F-Series	Jumpers 1 -2
E-Series	Jumpers 2 -3

You may want to double-check that the jumper settings are correct for your application while you have your enclosure off.

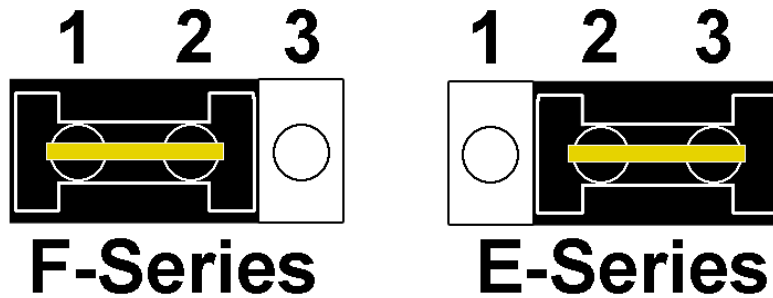

22. Once the default settings are correctly adjusted, you can slide the AutoLoc enclosure back together.

23. Before going on a test drive, you will need to connect a transmission oil pressure gauge to the transmission to ensure proper operating pressures. The pressure port is located on the driver's side of the vehicle.

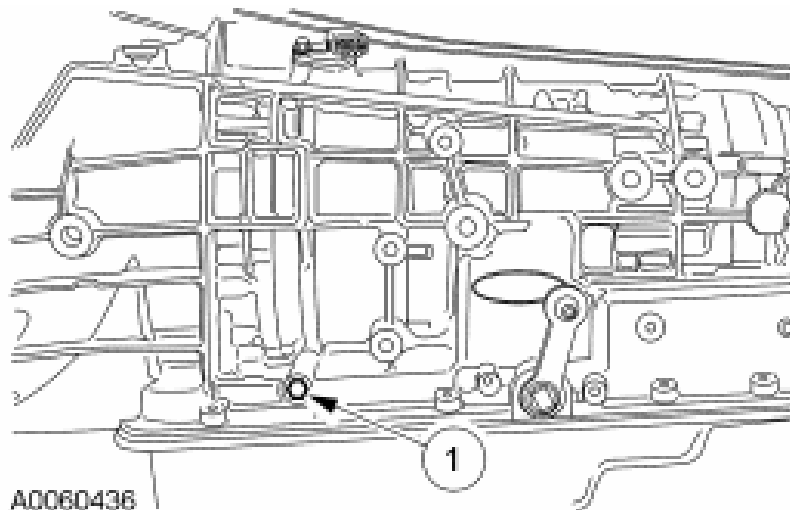

24. Once the pressure gauge is installed, take the vehicle for a test drive. With the exhaust brake on, drive until the torque converter clutch is commanded ON by the truck, and then let off of the accelerator pedal. The torque converter should still be engaged while the exhaust brake is on.

The desired settings of the AutoLoc are to disengage at 1250 RPM for lockup and the transmission pressure while decelerating in lockup should be 170-205psi. If these settings have not been reached, you can re-open the AutoLoc enclosure and adjust the potentiometers. **Turn clock wise for more pressure or higher RPM.**

The higher the pressure, the firmer and quicker the torque converter engagement will be.

Lockup pressure while decelerating with the exhaust brake on	170 – 205psi
Lockup disengagement	1250 RPM

Continue the test drive and adjustments until everything is functioning correctly. Remember, the AutoLoc functions only when the exhaust brake is on.

Once everything is operating correctly you can remove the transmission gauge and re-install the battery cover.

Wiring Diagram

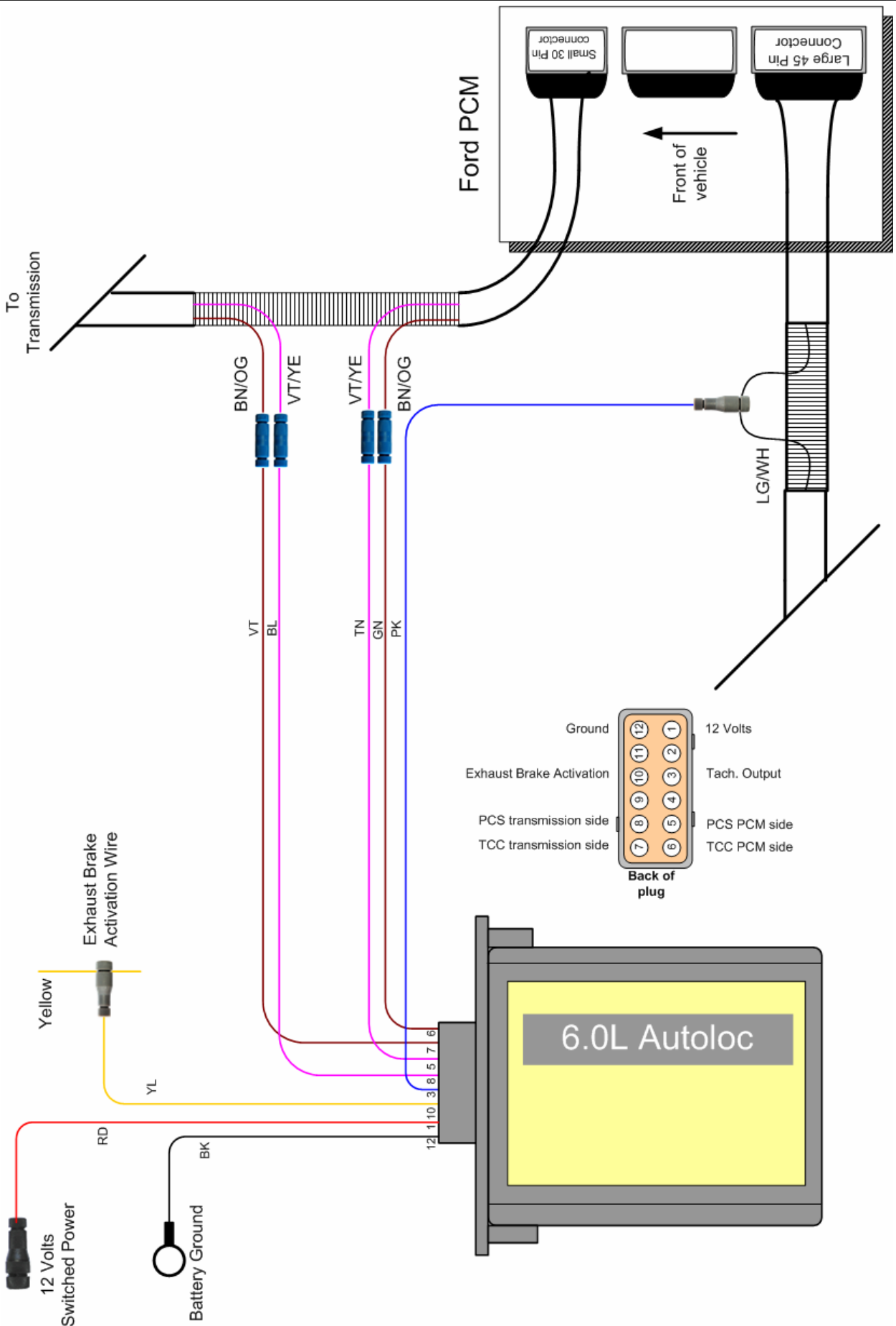

BD Engine Brake Inc.

Plant Address: Unit A10, 33733 King Rd, Abbotsford, BC, Canada V2S 7M9

U.S. Shipping Address: 88-446 Harrison St, Sumas, WA 98295 U.S. Mailing Address: P.O. Box 231, Sumas, WA 98295

Phone: 604-853-6096 Fax: 604-853-8749 Internet: www.bd-power.com

Troubleshooting

Problem	Symptom	Resolution
Vehicle starts in limp mode	High idle or harsh engagement	Double check wiring, and ensure connectors crimped properly. Use a voltmeter to check for voltages.
Unusual operation	Odd shifting or error code	Check wiring and/or potentiometer settings.
Harsh down shift	Harsh 1 st or 2 nd gear down shift	Increase the RPM cutout speed.
Soft/Hard Torque Converter Clutch engagement	Soft/Hard clutch engagement	Adjust the line pressure using the PCS potentiometer.
Does not activate	Does not hold lockup or increase line pressure	<p>Make sure exhaust brake is on and functioning.</p> <p>Check connection to exhaust brake activation wire.</p> <p>Check power (fuse) and ground.</p>

For ease of troubleshooting, if power is removed from the unit all factory signals will take precedence. For example, to diagnose an up-shifting problem, remove the power from the AutoLoc to properly diagnose the problem. With power removed from the AutoLoc, the factory transmission signals will not be altered, they will simply pass right through the unit and out. If the problem still occurs, you can connect the TCC and PCS wiring back together. Remember, the first step is to always check the wiring connections visibly and then with a voltmeter.

BD Engine Brake Inc.

Plant Address: Unit A10, 33733 King Rd, Abbotsford, BC, Canada V2S 7M9

U.S. Shipping Address: 88-446 Harrison St, Sumas, WA 98295 U.S. Mailing Address: P.O. Box 231, Sumas, WA 98295

Phone: 604-853-6096 Fax: 604-853-8749 Internet: www.bd-power.com

BD ENGINE BRAKE, INC.
LIMITED WARRANTY STATEMENT

THE INSTALLATION OF THIS PRODUCT INDICATES THAT THE BUYER HAS READ AND UNDERSTANDS THIS AGREEMENT AND ACCEPTS ITS TERMS AND CONDITIONS.

DISCLAIMER OF LIABILITY

BD Engine Brake Inc., its successors, distributors, jobbers, and dealers (hereafter "**BD**") shall in no way be responsible for the product's proper use and service. **THE BUYER HEREBY WAIVES ALL LIABILITY CLAIMS.**

BD disclaims any warranty and expressly disclaims any liability for personal injury or damages. **BD** also disclaims any liability for incidental or consequential damages including, but not limited to, repair labor, rental vehicles, hotel costs, or any other inconvenience costs by reason of use or sale of any such equipment. The **BUYER** acknowledges and agrees that the disclaimer of any liability for personal injury is a material term for this agreement and the **BUYER** agrees to indemnify **BD** and to hold **BD** harmless from any claim related to the item of any equipment purchased.

This warranty shall not apply to any unit that has been improperly stored or installed, or to misapplication, improper operation conditions, accidents, neglect, or which has been improperly repaired or altered or otherwise mistreated by the **BUYER** or his agent. **BD** also assumes no liability regarding the improper installation or misapplication of its products. It is the installer's responsibility to check for proper installation and if in doubt, contact the manufacturer.

LIMITATION OF WARRANTY

BD Engine Brake Inc. (hereafter "**BD**") warrants to the **BUYER** that any parts purchased shall be free from defects in material workmanship. A defect is defined as a condition within the product that would render the product inoperable. **BD** gives Limited Warranty as to description, quality, merchantability, fitness for any product's purpose, productiveness, or any other matter of **BD's** product sold herewith. **BD** shall be in no way responsible for the product's open use and service and the **BUYER** hereby waives all rights other than those expressly written herein. This Warranty shall not be extended or varied except by a written instrument signed by **BD** and the **BUYER**.

The Warranty is Limited to one (1) year from the date of sale and labor costs incurred by the removal and replacement of the BD product, while performing warranty work, will be covered for 1 (one) year, payable at BD rates, at authorized centers and with prior approval. Until BD has approved the claim, the consumer may be responsible for these costs.

A Return Authorization (WA) number, obtained in advance from **BD**, must accompany all products returned for warranty consideration. All products must be returned, shipping prepaid, to **BD** and must be accompanied by a dated proof of purchase receipt. All Warranty claims are subject to approval by **BD** and repaired or replaced product will be returned to the customer freight collect. Accepted warranty units, which have been replaced, become the sole property of **BD**.

This warranty is in lieu of all other warranties or guaranties, either expressed or implied, and shall not extend to any consumer or to any person other than the original purchaser residing within the boundaries of the continental U.S. or Canada.

IN THE EVENT THAT THE BUYER DOES NOT AGREE WITH THIS AGREEMENT, THE BUYER MAY PROMPTLY RETURN THIS PRODUCT, IN A NEW AND UNUSED CONDITION, WITH A DATED PROOF OF PURCHASE, TO THE PLACE OF PURCHASE WITHIN THIRTY (30) DAYS FROM DATE OF PURCHASE FOR A FULL REFUND.

BD Engine Brake Inc.

Plant Address: Unit A10, 33733 King Rd, Abbotsford, BC, Canada V2S 7M9

U.S. Shipping Address: 88-446 Harrison St, Sumas, WA 98295 U.S. Mailing Address: P.O. Box 231, Sumas, WA 98295

Phone: 604-853-6096 Fax: 604-853-8749 Internet: www.bd-power.com