

## Installation Guide for Chevrolet Camaro ZL1 PNs -140726, 140727



**\*\*\*\*\* Please compare the parts in the box with the bill of materials provided \*\*\*\*\*  
(view the following pages) to assure that you have all the parts necessary for this installation.**

These instructions have been written to help you with the installation of your Borla Performance System. Please read this document completely before beginning the installation of your system.

To ensure this part number fits your specific model year, please visit our website for the latest model year listings at [www.BORLA.com](http://www.BORLA.com)

**Thank you for purchasing a Borla Performance Exhaust System.**

**Borla Performance Exhaust Systems (PNs 140726, 140727) are designed for the Chevrolet Camaro ZL1, 6.2LV8 engine, with manual or automatic transmissions.**

Borla Performance Industries recommends that an exhaust shop or professional after market parts installer, who has all the necessary equipment, tools and experienced personnel needed for proper installation, should perform the installation of this system. However, if you decide to perform the installation, we recommend someone should help you. Ensure the installer uses all under car safety precautions including eye protection.

*Please take time to read and understand the following...*

By installing your Borla Performance Exhaust System, you indicate that you have read this document and you agree with the terms stated below.

It is the responsibility of the purchaser to follow all installation instruction guidelines and safety procedures supplied with your Borla Performance Exhaust System.

Borla Performance Industries assumes no responsibility for damages occurring from misuse, abuse, improper installation, improper operation, lack of responsible care, or all previously stated reasons resulting from incompatibility with other manufacturer's products and/or systems.

Included with your Borla Performance Exhaust System is a warranty card. Please read it carefully before you begin any work on your vehicle. If you should have any questions regarding our warranty policy, installation, or any other matter pertaining to your new Borla Performance Exhaust System, please give us a call at the number provided on the warranty card.

**Minimum Required Tool List:**

**TOOLS:**

1. 3/8” Drive Ratchet
2. 3/8” Drive Extension 9”
3. 15mm Socket
4. 15mm Wrench
5. 14mm Socket
6. 14mm Wrench
7. Pry Bar

**SHOP SUPPLIES:**

- 1 Spray Lubricant

**Borla Performance - Bill of Materials**

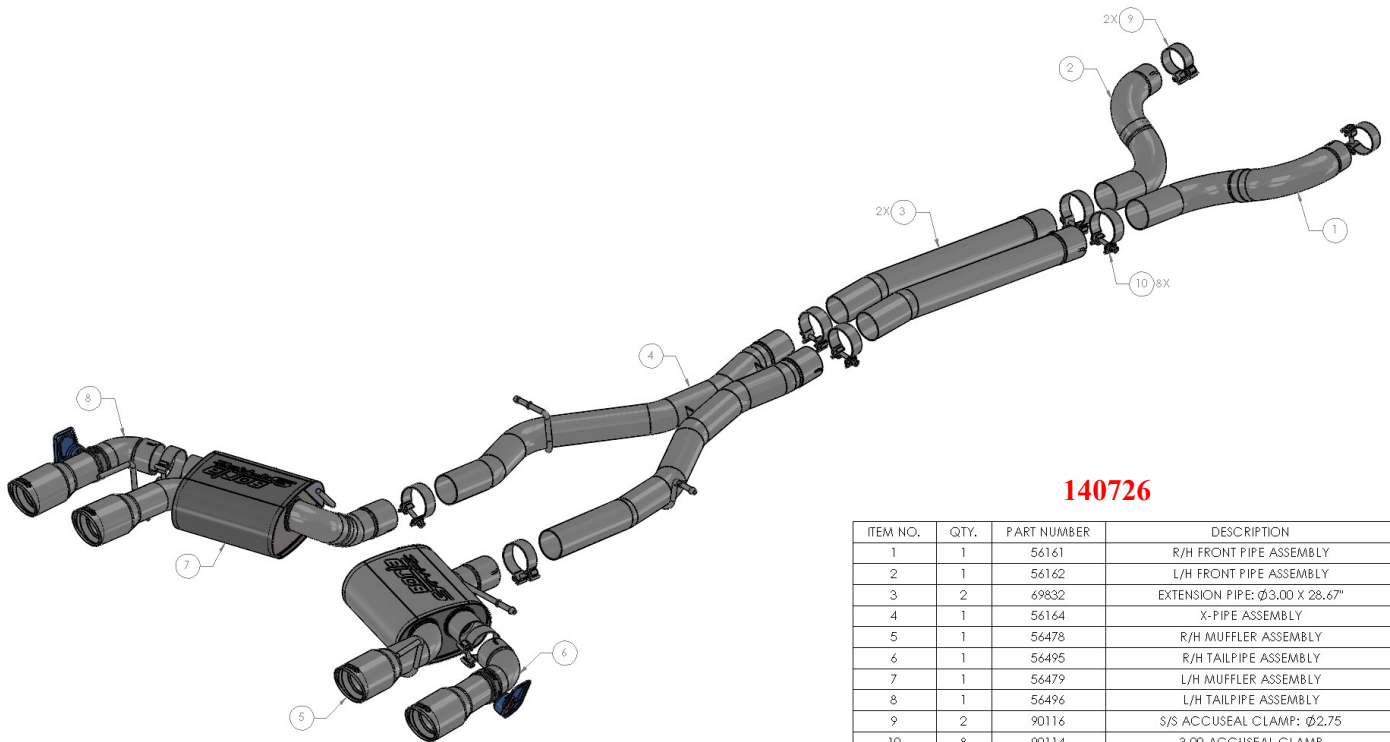

ITEM NO.	QTY.	PART NUMBER	DESCRIPTION
1	1	56161	R/H FRONT PIPE ASSEMBLY
2	1	56162	L/H FRONT PIPE ASSEMBLY
3	2	69832	EXTENSION PIPE: Ø3.00 X 28.67"
4	1	56164	X-PIPE ASSEMBLY
5	1	56478	R/H MUFFLER ASSEMBLY
6	1	56495	R/H TAILPIPE ASSEMBLY
7	1	56479	L/H MUFFLER ASSEMBLY
8	1	56496	L/H TAILPIPE ASSEMBLY
9	2	90116	S/S ACCUSEAL CLAMP: Ø2.75
10	8	90114	3.00 ACCUSEAL CLAMP

**Minimum Required Tool List:**

**TOOLS:**

1. 3/8” Drive Ratchet
2. 3/8” Drive Extension 9”
3. 15mm Socket
4. 15mm Wrench
5. 14mm Socket
6. 14mm Wrench
7. Pry Bar

**SHOP SUPPLIES:**

- 1 Spray Lubricant

**Borla Performance - Bill of Materials**

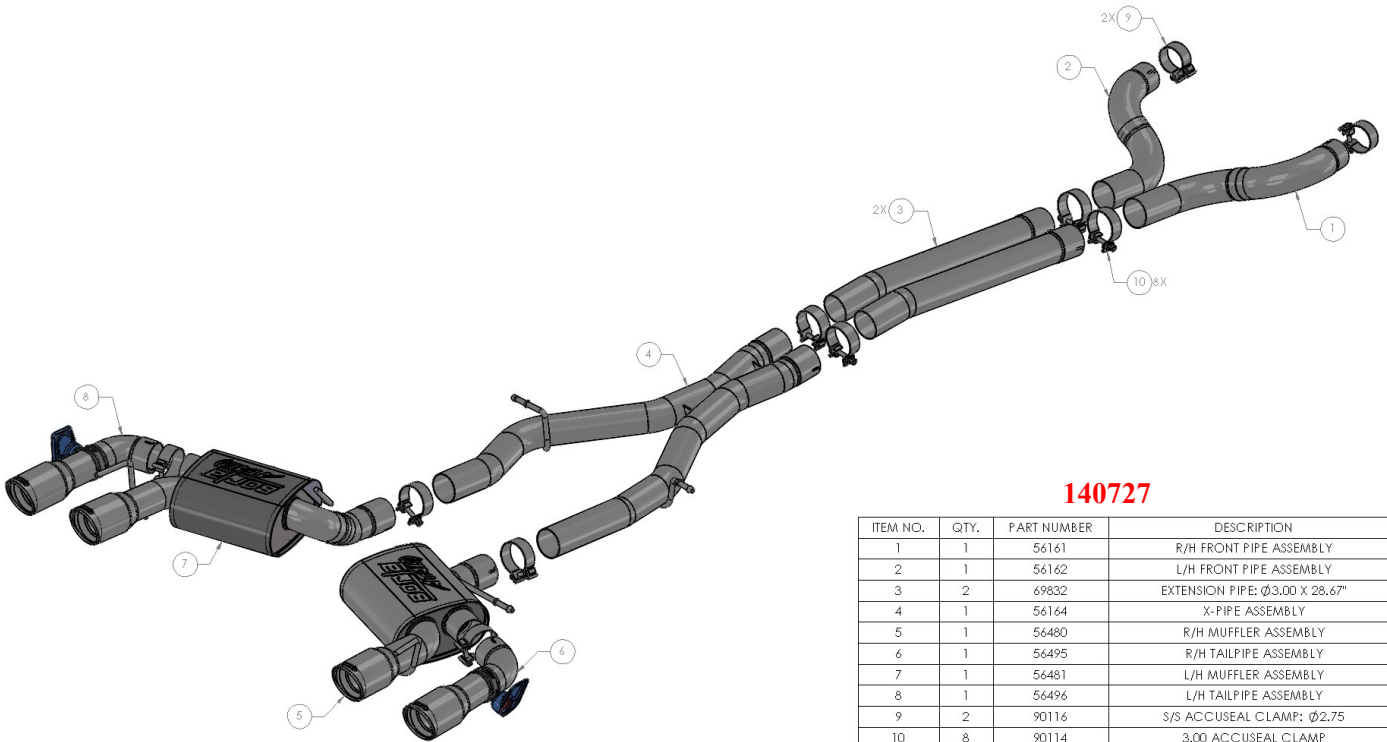

ITEM NO.	QTY.	PART NUMBER	DESCRIPTION
1	1	56161	R/H FRONT PIPE ASSEMBLY
2	1	56162	L/H FRONT PIPE ASSEMBLY
3	2	69832	EXTENSION PIPE: Ø3.00 X 28.67"
4	1	56164	X-PIPE ASSEMBLY
5	1	56480	R/H MUFFLER ASSEMBLY
6	1	56495	R/H TAILPIPE ASSEMBLY
7	1	56481	L/H MUFFLER ASSEMBLY
8	1	56496	L/H TAILPIPE ASSEMBLY
9	2	90116	S/S ACCUSEAL CLAMP: Ø2.75
10	8	90114	3.00 ACCUSEAL CLAMP

**Caution!!!** *Never work on a hot exhaust system. Serious injury in the form of burns can result. If the vehicle has been in use and the exhaust system is hot, allow vehicle to cool for at least 1 hour. Always wear eye protection when working under any vehicle.*

**Note:** *It is our recommendation that you use a hoist or hydraulic lift to facilitate the installation of your new Borla Performance Exhaust System.*

**Taking all under car safety precautions, lift the vehicle using a hoist or hydraulic lift. Once this has been done, you may begin the removal of your old exhaust system from your vehicle.**

**Note:** *Before removing the original exhaust system from your vehicle, please compare the parts you have received with the bill of materials provided on the previous page to assure that you have all the parts necessary for the installation of your new Borla Performance Exhaust System.*

**Note:** *With a used vehicle, we suggest a penetrating spray lubricant to be applied liberally to all exhaust fasteners and allowing a significant period of time for the chemical to lubricate the threads before attempting to disassemble.*

## Original Exhaust System Removal

1. Remove factory cross-brace keeping hardware for installation later. (See Fig. 1)
2. Factory Mid Pipe needs to be cut as shown. (See Fig. 2A)
3. Beginning with left-side, measure and mark a cutting line 3-1/4" behind factory catalytic converter as shown. (See Fig. 2B) On right-side, measure and mark a cutting line 4-1/4" behind factory catalytic converter as shown. (See Fig. 2C)
4. Exhaust system can be removed in 1-piece. Beginning at the rear left side, locate and remove (2) nuts on Left-Side Hanger Bracket and remove hanger from bracket. Keep Hanger Bracket and hardware for reinstallation. (See Fig 3)
5. Repeat STEP 5 for Right-Side Hanger removal.
6. Support the factory mid pipe with a muffler stand. Cut the pipe at the marks using a metal-cutting chain tool or sawsall. Deburr the cut edges.
7. Remove hangers from rubber isolators and carefully remove factory midpipe from vehicle. (See Fig. 4)

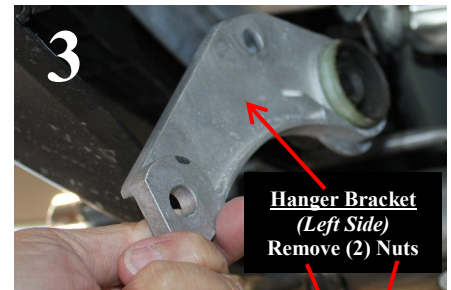
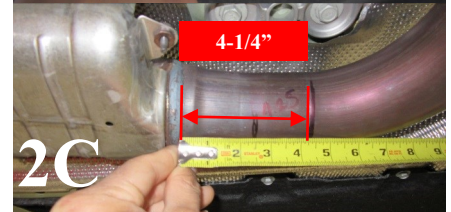
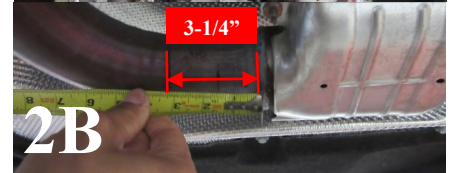
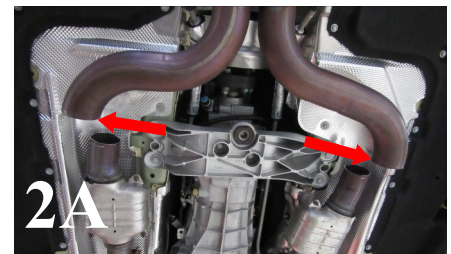
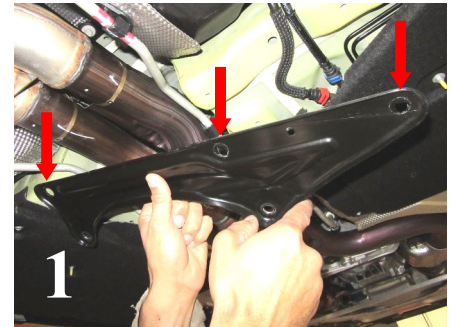



## Borla Performance Exhaust Installation

1. Starting on right side, place a clamp on expanded end of the **R/H Front Pipe Assembly**. (See Fig. 5) Do not tighten clamp.
2. Repeat STEP 1 to install **L/H Front Pipe Assembly**. Do not tighten clamp.
3. Place a clamp on **R/H & L/H Side Extension Pipes** and set it up into position. (See Fig. 6) Do not tighten clamps.
4. Place a clamp on the inlet of each **X-Pipe** and insert into the **Extension Pipe** outlets. Insert the hangers into the rubber isolators. (See Fig. 7) Do not tighten clamps.
5. Place a clamp on the inlet of the **R/H Muffler Assembly** and insert into into the R/H outlet of the **X-Pipe**. Insert the hanger into the rubber isolator. (See Fig. 8) Do not tighten clamp.
6. Repeat the STEP 5 for the **L/H Muffler Assembly**. (See Fig. 9) Do not tighten clamps.

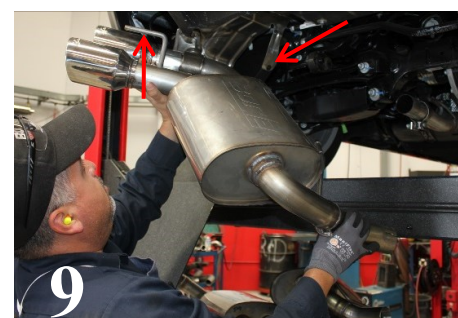
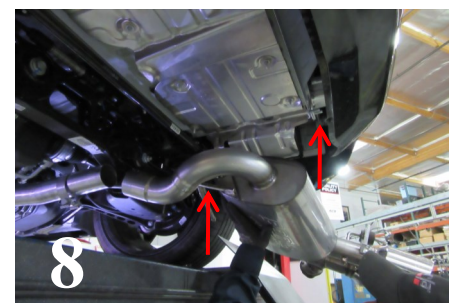
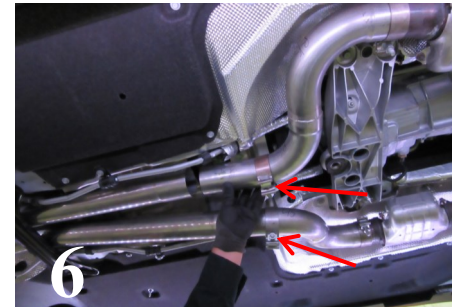
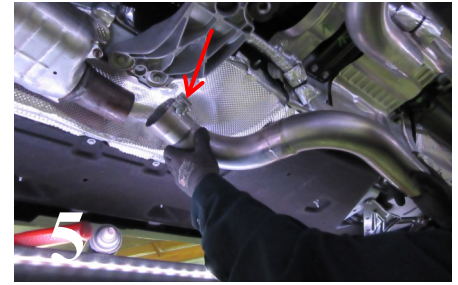

**WARNING:** Use extreme caution during installation. Torque all fasteners according to manufacturer's torque values and tightening sequence. **DO NOT** use air impact tools to tighten fasteners on Borla Performance Exhaust Systems. Use of such tools may result in bent flanges or gasket contact areas leading to exhaust leaks.

**NOTE:** When you first start your vehicle after the installation of your new Borla Performance Exhaust System, there may be some smoke and fumes coming from the system. This is a protective oil based coating used in the manufacturing of mandrel bent performance exhaust tubing. This is not a problem and will disappear within a very short period of time after the exhaust has reached normal operating temperatures.

## Borla Performance Exhaust Installation (cont'd)

7. Reinstall factory left-side hanger bracket to **L/H Muffler Assembly** to vehicle. Tighten nuts to 12 ft. lbs. (See Fig. 11)
8. Repeat STEP 7 to reinstall factory hanger bracket to vehicle for **R/H Muffler Assembly**. (See Fig. 12)
9. Check your exhaust system for proper clearance under the vehicle and also for tip centering to valence. (See Fig. 13)
10. Once position has been determined to be correct, tighten the Muffler Assembly inlet clamp bolts; then the Tailpipe Assembly Tip clamp bolts, 32-35 ft. lbs. (See Fig. 14)
11. Before starting your vehicle, make sure to check all wires, hoses, brake lines, body parts and tires for safe clearance from the exhaust system. (See Fig. 15)
12. Start vehicle and check for any leaks. If any leaks are found, determine cause (such as loose or incorrectly positioned clamp) and repair as necessary.

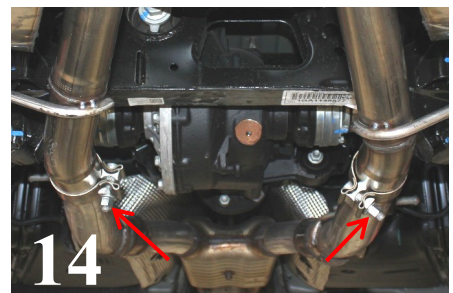
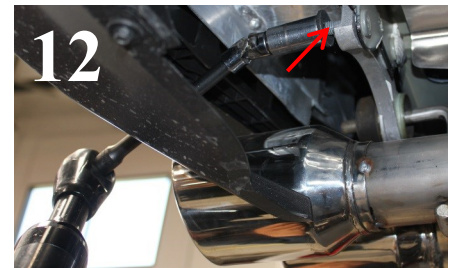
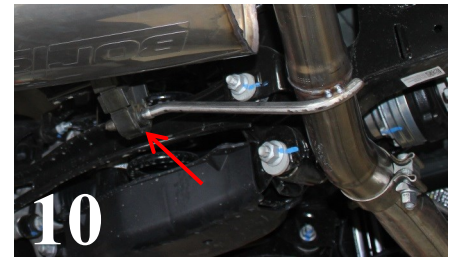

**WARNING:** Use extreme caution during installation. Torque all fasteners according to manufacturer's torque values and tightening sequence. DO NOT use air impact tools to tighten fasteners on Borla Performance Exhaust Systems. Use of such tools may result in bent flanges or gasket contact areas leading to exhaust leaks.

**NOTE:** When you first start your vehicle after the installation of your new Borla Performance Exhaust System, there may be some smoke and fumes coming from the system. This is a protective oil based coating used in the manufacturing of mandrel bent performance exhaust tubing. This is not a problem and will disappear within a very short period of time after the exhaust has reached normal operating temperatures.