

Installation for Mazda Miata (ND) PN - 60594*



******* Please compare the parts in the box with the bill of materials provided *****
to assure that you have all the parts necessary for this installation.**

These instructions have been written to help you with the installation of your Borla Performance Exhaust System. Please read this document completely before beginning the installation of your system.

To ensure this part number fits your specific model year, please visit our website for the latest model year listings at www.BORLA.com

Thank you for purchasing a Borla Performance Exhaust Component.

Borla Performance Mid Pipe (PN-60594) is designed for the Mazda Miata (ND) equipped with a 2.0L engine, automatic or manual transmissions.

*** FOR COMPETITION USE ONLY. Not emissions compliant for street use.**

Borla Performance Industries recommends that an exhaust shop or professional after market parts installer perform the installation of this system. However, if you decide to perform the installation on your own it is recommended that two people are used. This installation should not be performed by one person due to the risk of injury. Ensure the installers use all under car safety precautions including eye protection.

Please take time to read and understand the following...

By installing your Borla Performance Exhaust System, you indicate that you have read this document and you agree with the terms stated below.

It is the responsibility of the purchaser to follow all installation instruction guidelines and safety procedures supplied with your Borla Performance Exhaust System.

Borla Performance Industries assumes no responsibility for damages occurring from misuse, abuse, improper installation, improper operation, lack of responsible care, or all previously stated reasons resulting from incompatibility with other manufacturer's products and/or systems.

Included with your Borla Performance Exhaust System is a warranty card. Please read it carefully before you begin any work on your vehicle. If you should have any questions regarding our warranty policy, installation, or any other matter pertaining to your new Borla Performance Exhaust System, please give us a call at the number provided on the warranty card.

Minimum Required Tool List:

TOOLS:

- 1 3/8" Drive Ratchet
- 2 3/8" Drive Extension 3"
- 3 13mm Socket
- 5 Pry Bar

SHOP SUPPLIES:

- 1 Spray Lubricant

Borla Performance - Bill of Materials

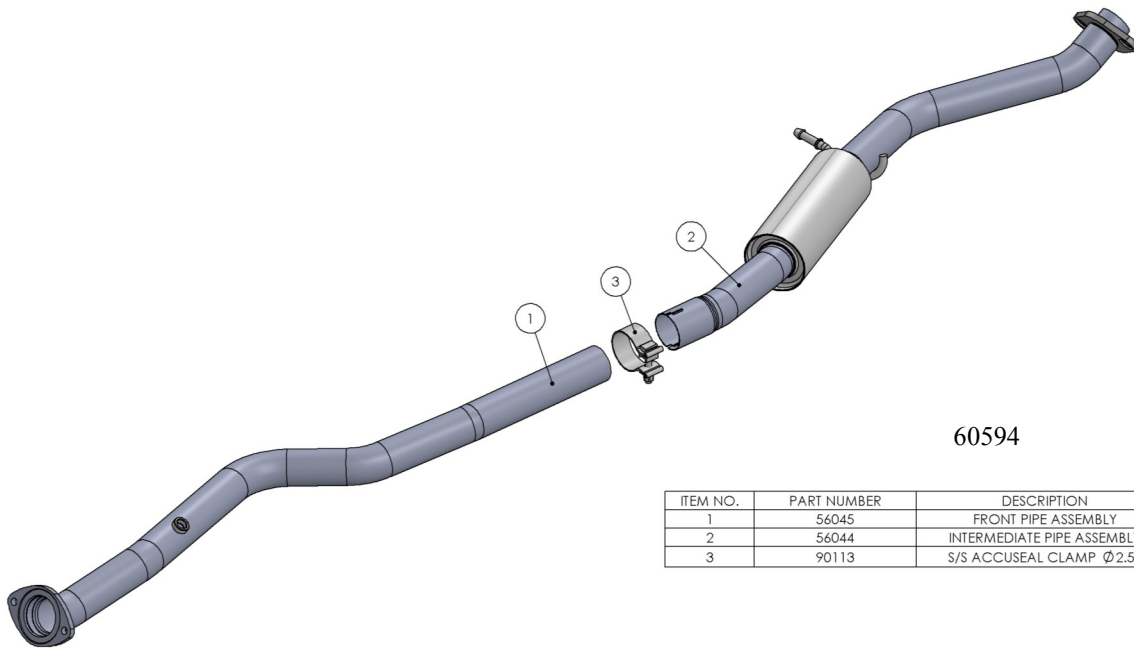

60594

ITEM NO.	PART NUMBER	DESCRIPTION	QTY.
1	56045	FRONT PIPE ASSEMBLY	1
2	56044	INTERMEDIATE PIPE ASSEMBLY	1
3	90113	S/S ACCUSEAL CLAMP Ø2.50	1

Caution!!! *Never work on a hot exhaust system. Serious injury in the form of burns can result if the vehicle has been in use and the exhaust system is hot, allow vehicle to cool for at least 1 hour. Always wear eye protection when working under any vehicle.*

Note: *It is our recommendation that you use a hoist or hydraulic lift to facilitate the installation of your new Borla Performance Exhaust System.*

Taking all under car safety precautions, lift the vehicle using a hoist or hydraulic lift. Once this has been done, you may begin the removal of your old exhaust system from your vehicle.

Note: *Before removing the original exhaust system from your vehicle, please compare the parts you have received with the bill of materials provided on the previous page to assure that you have all the parts necessary for the installation of your new Borla Performance Exhaust System.*

Note: *With a used vehicle, we suggest a penetrating spray lubricant to be applied liberally to all exhaust fasteners and allowing a significant period of time for the chemical to lubricate the threads before attempting to disassemble.*

Original System Removal

1. Remove factory cross brace. Keep hardware for re-installation. (See Fig. 1)
2. Loosen (2) flange nuts using a 13mm socket, put hardware to the side. **NOTE: Reuse factory gasket.** DISCONNECT O2 SENSOR HARNESS AS SHOWN (See Figs. 1 & 2)
3. Remove OE Rear Muffler:
 - A. Loosen (2) flange nuts using a 13mm socket, put hardware to the side. **NOTE: Keep factory gasket for reinstallation.**
 - B. Using a muffler stand or an additional person to hold the muffler assembly, slide the (4) hangers out of the rubber isolators and remove the system from the rear. Keep the hardware for use during the installation of your new exhaust system. (See Fig. 3)
4. Carefully remove hangers from rubber isolators and remove OE mid pipe from vehicle. (See Figs. 4 & 5)

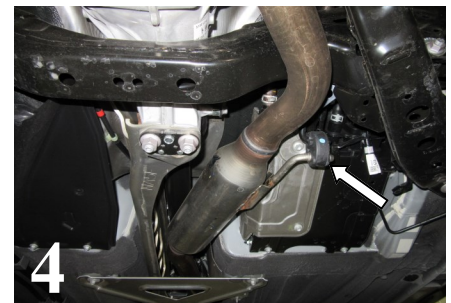
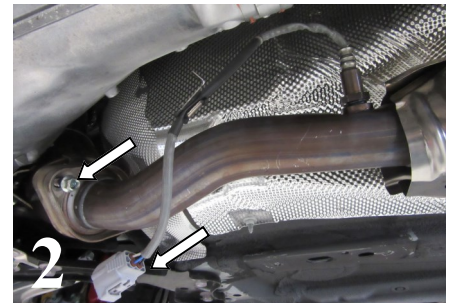
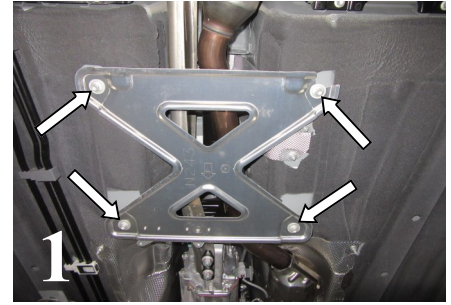

WARNING: *Use extreme caution during installation. Torque all fasteners according to manufacturer's torque values and tightening sequence. **DO NOT** use air impact tools to tighten fasteners on Borla Performance Exhaust Systems. Use of such tools may result in bent flanges or gasket contact areas leading to exhaust leaks.*

NOTE: *When you first start your vehicle after the installation of your new Borla Performance Exhaust System, there may be some smoke and fumes coming from the system. This is a protective oil based coating used in the manufacturing of mandrel bent performance exhaust tubing. This is not a problem and will disappear within a very short period of time after the exhaust has reached normal operating temperatures.*

Borla Performance Component Installation

1. Install Front Pipe Assembly to front flange using factory hardware. (See Fig. 6)
2. Install O2 Sensor to Front Pipe Assembly. Re-connect wire harness to vehicle wire harness. (See Fig. 7)
3. Place the clamp over the expanded end of the Intermediate Pipe Assembly and insert inlet into Front Pipe Assembly. Insert hanger into rubber isolator. (See Figs. 8 & 9)
4. Install rear muffler (if Borla PN-11919 refer to installation instructions) to vehicle using factory hardware and gasket.
5. Reinstall cross brace to vehicle and tighten hardware 12-15 ft. lbs.
6. Check your exhaust system for proper clearance under the vehicle and also for tip alignment. Once position has been determined to be correct, tighten the clamp bolts, 32-35 ft. lbs. Then tighten the flange bolts, 12-15 ft. lbs. (See Fig. 10)
7. Before starting your vehicle, make sure to check all wires, hoses, brake lines, body parts and tires for safe clearance from the exhaust system.
8. Start vehicle and check for any leaks. If any leaks are found, determine cause (such as loose or incorrectly positioned clamp) and repair as necessary.

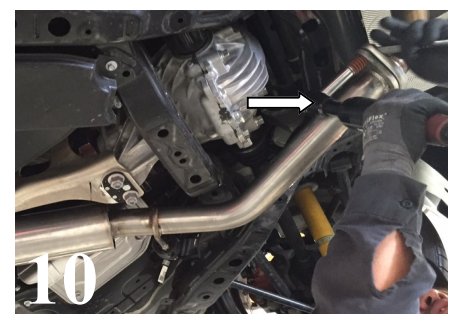
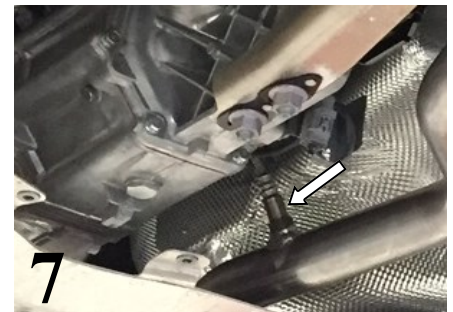
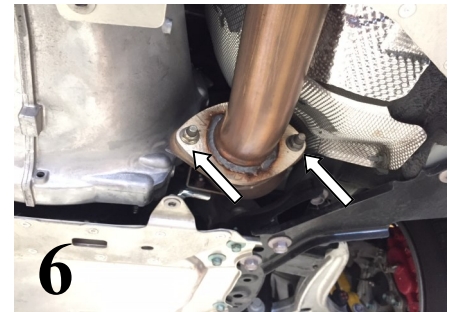

WARNING: Use extreme caution during installation. Torque all fasteners according to manufacturer's torque values and tightening sequence. **DO NOT** use air impact tools to tighten fasteners on Borla Performance Exhaust Systems. Use of such tools may result in bent flanges or gasket contact areas leading to exhaust leaks.

NOTE: When you first start your vehicle after the installation of your new Borla Performance Exhaust System, there may be some smoke and fumes coming from the system. This is a protective oil based coating used in the manufacturing of mandrel bent performance exhaust tubing. This is not a problem and will disappear within a very short period of time after the exhaust has reached normal operating temperatures.