

## Chevrolet Camaro (Gen6) Installation Guide PN- 60606, 60607, 60608, 60609, 60610, 60611



**\*\*\*\*\* Please compare the parts in the box with the bill of materials provided \*\*\*\*\*  
(view the following pages) to assure that you have all the parts necessary for this installation.**

These instructions have been written to help you with the installation of your Borla Performance System. Please read this document completely before beginning the installation of your system.

To ensure this part number fits your specific model year, please visit our website for the latest model year listings at [www.BORLA.com](http://www.BORLA.com)

**Thank you for purchasing a Borla Performance Exhaust System.**

**Borla Performance Exhaust Systems (PNs 60606, 60607, 60608, 60609, 60610) are designed for the Chevrolet Camaro 6.2L V8 engine with manual or automatic transmissions.**

**Borla Performance Exhaust System (PN 60611) is designed for the Chevrolet Camaro 3.6L V6 engine with manual or automatic transmissions. FOR COMPETITION USE ONLY. THIS SYSTEM IS NOT EMISSIONS COMPLIANT.**

**These systems designed to compliment Borla Rear Section Exhaust Systems. They are NOT designed to work with the factory rear mufflers.**

Borla Performance Industries recommends that an exhaust shop or professional after market parts installer, who has all the necessary equipment, tools and experienced personnel needed for proper installation, should perform the installation of this system. However, if you decide to perform the installation, we recommend someone should help you. Ensure the installer uses all under car safety precautions including eye protection.

*Please take time to read and understand the following...*

By installing your Borla Performance Exhaust System, you indicate that you have read this document and you agree with the terms stated below.

It is the responsibility of the purchaser to follow all installation instruction guidelines and safety procedures supplied with your Borla Performance Exhaust System.

Borla Performance Industries assumes no responsibility for damages occurring from misuse, abuse, improper installation, improper operation, lack of responsible care, or all previously stated reasons resulting from incompatibility with other manufacturer's products and/or systems.

Included with your Borla Performance Exhaust System is a warranty card. Please read it carefully before you begin any work on your vehicle. If you should have any questions regarding our warranty policy, installation, or any other matter pertaining to your new Borla Performance Exhaust System, please give us a call at the number provided on the warranty card.

**Minimum Required Tool List:**

**TOOLS:**

1. 3/8” Drive Ratchet
2. 3/8” Drive Extension 9”
3. 15mm Socket
4. 15mm Wrench
5. 14mm Socket
6. 14mm Wrench
7. Pry Bar

**SHOP SUPPLIES:**

- 1 Spray Lubricant

**Borla Performance - Bill of Materials**

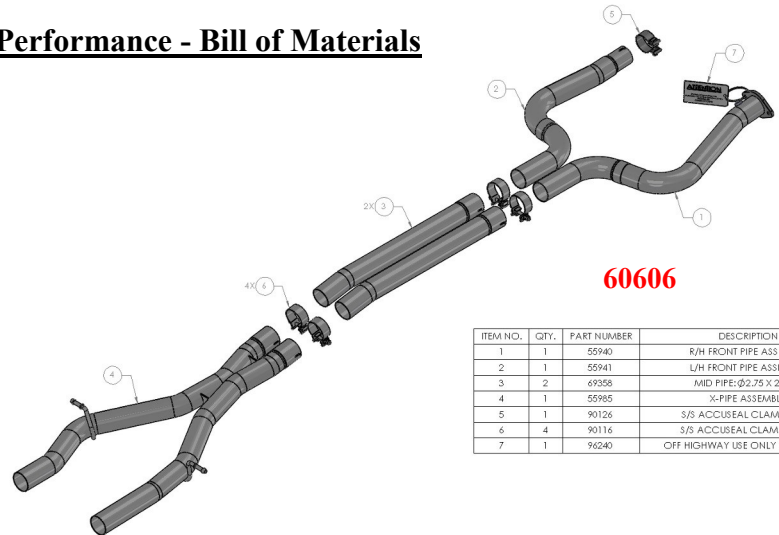

**60606**

ITEM NO.	QTY.	PART NUMBER	DESCRIPTION
1	1	55940	R/H FRONT PIPE ASSEMBLY
2	1	55941	L/H FRONT PIPE ASSEMBLY
3	2	69358	MID PIPE: Ø2.75 X 28.55"
4	1	55985	X-PIPE ASSEMBLY
5	1	90126	S/S ACCUSEAL CLAMP: Ø2.38
6	4	90116	S/S ACCUSEAL CLAMP: Ø2.75
7	1	96240	OFF HIGHWAY USE ONLY DISCLAIMER

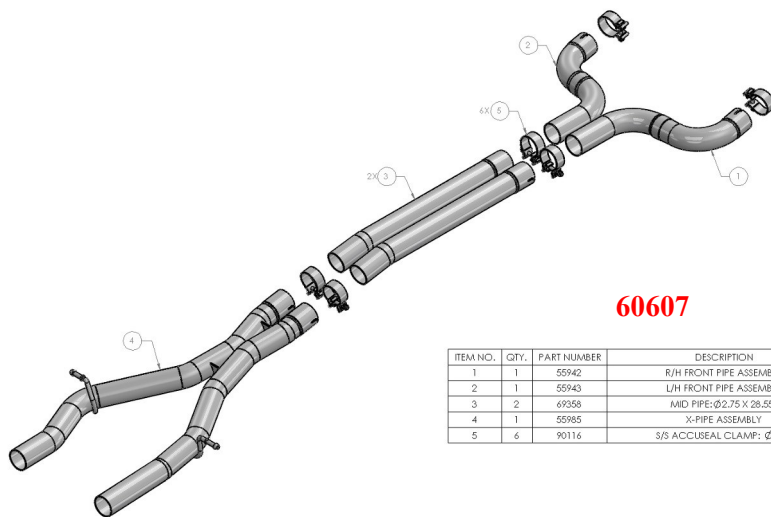

**60607**

ITEM NO.	QTY.	PART NUMBER	DESCRIPTION
1	1	55942	R/H FRONT PIPE ASSEMBLY
2	1	55943	L/H FRONT PIPE ASSEMBLY
3	2	69358	MID PIPE: Ø2.75 X 28.55"
4	1	55985	X-PIPE ASSEMBLY
5	6	90116	S/S ACCUSEAL CLAMP: Ø2.75

**Minimum Required Tool List:**

**TOOLS:**

1. 3/8” Drive Ratchet
2. 3/8” Drive Extension 9”
3. 15mm Socket
4. 15mm Wrench
5. 14mm Socket
6. 14mm Wrench
7. Pry Bar

**SHOP SUPPLIES:**

- 1 Spray Lubricant

**Borla Performance - Bill of Materials**

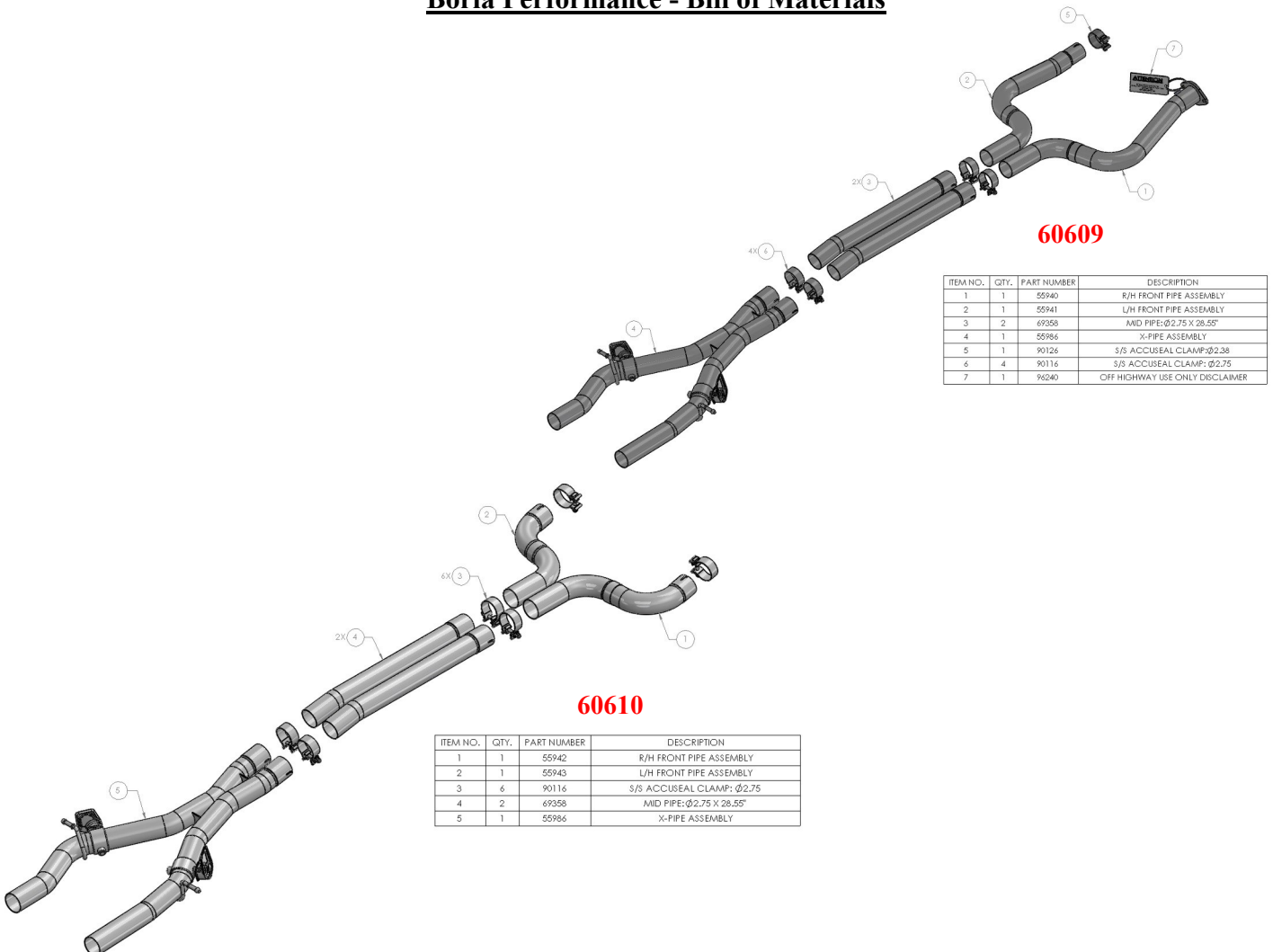

**60609**

ITEM NO.	QTY.	PART NUMBER	DESCRIPTION
1	1	55940	R/H FRONT PIPE ASSEMBLY
2	1	55941	L/H FRONT PIPE ASSEMBLY
3	2	69358	M/D PIPE: Ø2.75 X 28.55"
4	1	55986	X-PIPE ASSEMBLY
5	1	90126	S/S ACCUSEAL CLAMP: Ø2.38
6	4	90116	S/S ACCUSEAL CLAMP: Ø2.75
7	1	96240	OFF HIGHWAY USE ONLY DISCLAIMER

**60610**

ITEM NO.	QTY.	PART NUMBER	DESCRIPTION
1	1	55942	R/H FRONT PIPE ASSEMBLY
2	1	55943	L/H FRONT PIPE ASSEMBLY
3	6	90116	S/S ACCUSEAL CLAMP: Ø2.75
4	2	69358	M/D PIPE: Ø2.75 X 28.55"
5	1	55986	X-PIPE ASSEMBLY

**Minimum Required Tool List:**

**TOOLS:**

1. 3/8" Drive Ratchet
2. 3/8" Drive Extension 9"
3. 15mm Socket
4. 15mm Wrench
5. 14mm Socket
6. 14mm Wrench
7. Pry Bar

**SHOP SUPPLIES:**

- 1 Spray Lubricant

**Borla Performance - Bill of Materials**

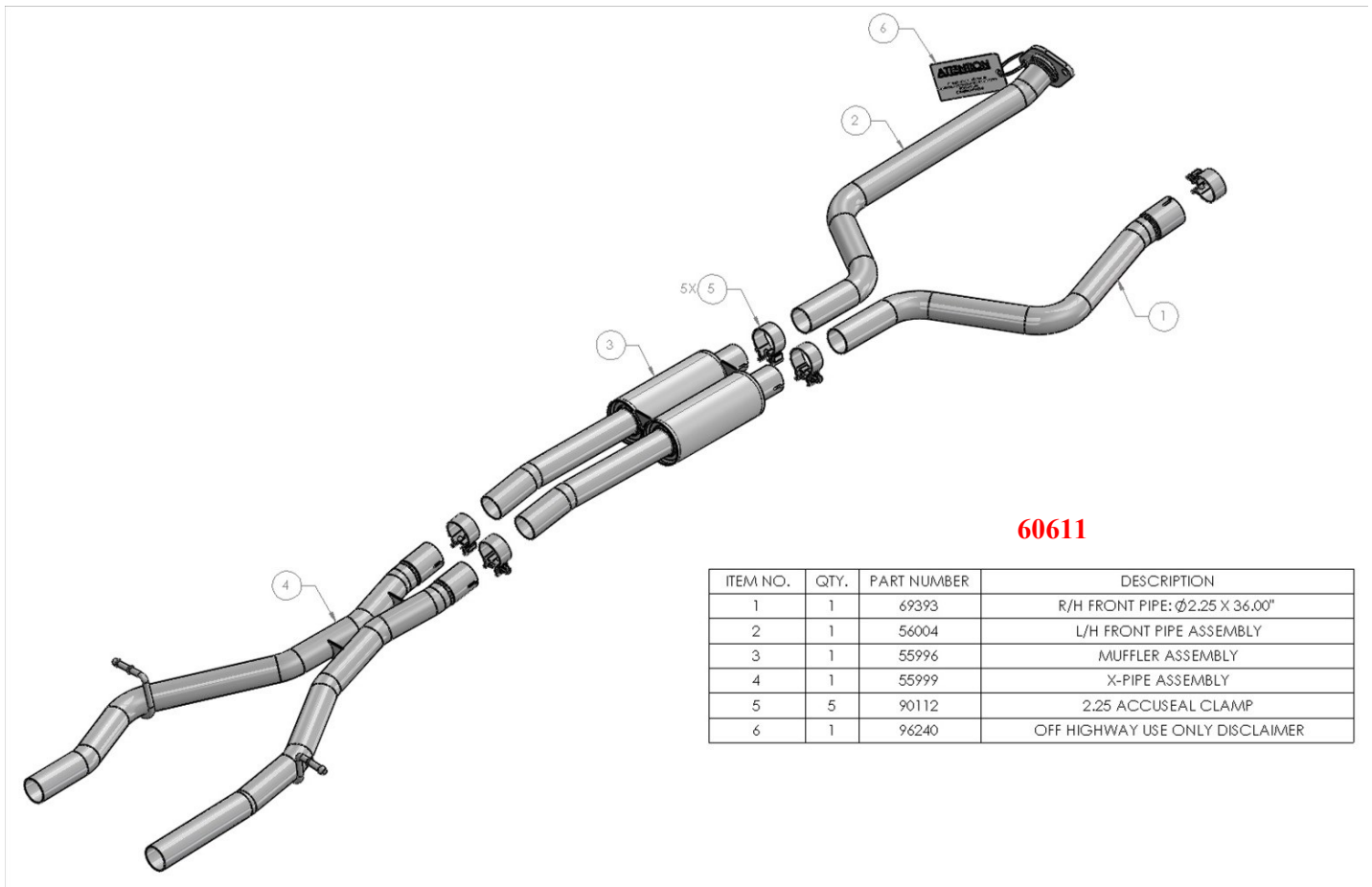

ITEM NO.	QTY.	PART NUMBER	DESCRIPTION
1	1	69393	R/H FRONT PIPE: $\phi$ 2.25 X 36.00"
2	1	56004	L/H FRONT PIPE ASSEMBLY
3	1	55996	MUFFLER ASSEMBLY
4	1	55999	X-PIPE ASSEMBLY
5	5	90112	2.25 ACCUSEAL CLAMP
6	1	96240	OFF HIGHWAY USE ONLY DISCLAIMER

**60611**

**Minimum Required Tool List:**

**TOOLS:**

1. 3/8" Drive Ratchet
2. 3/8" Drive Extension 9"
3. 15mm Socket
4. 15mm Wrench
5. 14mm Socket
6. 14mm Wrench
7. Pry Bar

**SHOP SUPPLIES:**

- 1 Spray Lubricant

**Borla Performance - Bill of Materials**

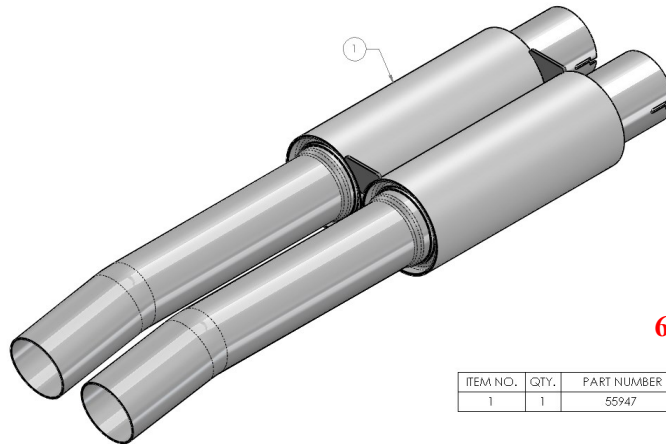

**60608**

ITEM NO.	QTY.	PART NUMBER	DESCRIPTION
1	1	55947	MUFFLER ASSEMBLY

**Caution!!!** *Never work on a hot exhaust system. Serious injury in the form of burns can result if the vehicle has been in use and the exhaust system is hot, allow vehicle to cool for at least 1 hour. Always wear eye protection when working under any vehicle.*

**Note:** *It is our recommendation that you use a hoist or hydraulic lift to facilitate the installation of your new Borla Performance Exhaust System.*

*Taking all under car safety precautions, lift the vehicle using a hoist or hydraulic lift. Once this has been done, you may begin the removal of your old exhaust system from your vehicle.*

**Note:** *Before removing the original exhaust system from your vehicle, please compare the parts you have received with the bill of materials provided on the previous page to assure that you have all the parts necessary for the installation of your new Borla Performance Exhaust System.*

**Note:** *With a used vehicle, we suggest a penetrating spray lubricant to be applied liberally to all exhaust fasteners and allowing a significant period of time for the chemical to lubricate the threads before attempting to disassemble.*

## (PNs-60607, 60610 ONLY)

### Original Exhaust System Removal

1. Remove Rear Mufflers (REFER TO BORLA REAR SECTION INSTALLATION GUIDE).
2. Remove factory cross brace and keep hardware for installation later.
3. Factory Mid Pipe needs to be cut as shown. (See Fig. 2A)
4. Beginning with left-side, measure and mark a cutting line 3-1/4" behind factory catalytic converter as shown. On right-side, measure and mark a cutting line 4-1/4" behind factory catalytic converter as shown.
5. **PN-60610 ONLY: Disconnect wire harness from AFM valve.**
6. Support the factory mid pipe with a muffler stand. Cut the pipe at the marks using a metal-cutting chain tool or sawsall. Deburr the cut edges.
7. Remove hangers from rubber isolators and carefully remove factory midpipe from vehicle. (See Figs. 3 & 4)

**WARNING:** *Use extreme caution during installation. Torque all fasteners according to manufacturer's torque values and tightening sequence. **DO NOT** use air impact tools to tighten fasteners on Borla Performance Exhaust Systems. Use of such tools may result in bent flanges or gasket contact areas leading to exhaust leaks.*

**NOTE:** *When you first start your vehicle after the installation of your new Borla Performance Exhaust System, there may be some smoke and fumes coming from the system. This is a protective oil based coating used in the manufacturing of mandrel bent performance exhaust tubing. This is not a problem and will disappear within a very short period of time after the exhaust has reached normal operating temperatures.*

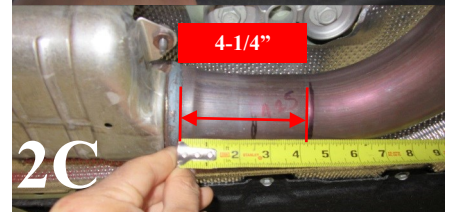
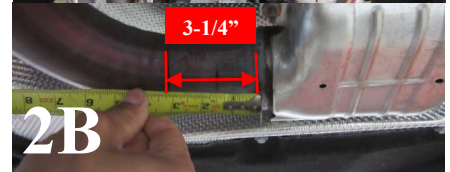
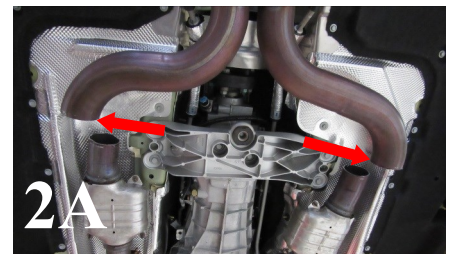
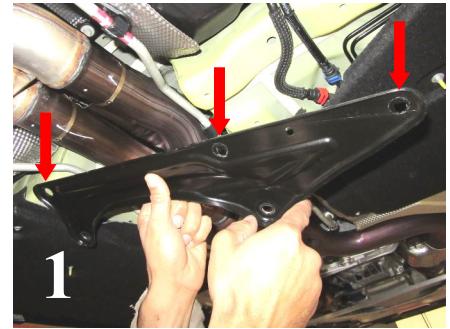

**Caution!!!** *Never work on a hot exhaust system. Serious injury in the form of burns can result if the vehicle has been in use and the exhaust system is hot, allow vehicle to cool for at least 1 hour. Always wear eye protection when working under any vehicle.*

**Note:** *It is our recommendation that you use a hoist or hydraulic lift to facilitate the installation of your new Borla Performance Exhaust System.*

**Taking all under car safety precautions, lift the vehicle using a hoist or hydraulic lift. Once this has been done, you may begin the removal of your old exhaust system from your vehicle.**

**Note:** *Before removing the original exhaust system from your vehicle, please compare the parts you have received with the bill of materials provided on the previous page to assure that you have all the parts necessary for the installation of your new Borla Performance Exhaust System.*

**Note:** *With a used vehicle, we suggest a penetrating spray lubricant to be applied liberally to all exhaust fasteners and allowing a significant period of time for the chemical to lubricate the threads before attempting to disassemble.*

## (PNs-60606, 60609 ONLY) Original Exhaust System Removal

1. Remove Rear Mufflers (REFER TO BORLA REAR SECTION INSTALLATION GUIDE). Disconnect left and right side O2 sensors from mid pipe.
2. Remove factory cross brace and keep hardware for installation later. Support the factory mid pipe with a muffler stand.
3. **PN-60609 ONLY: Disconnect wire harness from AFM valve.**
4. **LEFT SIDE:** Loosen clamp in front of catalytic converter. Cut tab and remove clamp from pipe. (See Figs. 6A & 6B)
5. **RIGHT SIDE:** Loosen (2) nuts and keep hardware for reinstallation later. (See Fig. 7)
6. Remove hangers from rubber isolators and carefully remove factory mid pipe from vehicle. (See Fig. 8)

**WARNING:** *Use extreme caution during installation. Torque all fasteners according to manufacturer's torque values and tightening sequence. **DO NOT** use air impact tools to tighten fasteners on Borla Performance Exhaust Systems. Use of such tools may result in bent flanges or gasket contact areas leading to exhaust leaks.*

**NOTE:** *When you first start your vehicle after the installation of your new Borla Performance Exhaust System, there may be some smoke and fumes coming from the system. This is a protective oil based coating used in the manufacturing of mandrel bent performance exhaust tubing. This is not a problem and will disappear within a very short period of time after the exhaust has reached normal operating temperatures.*

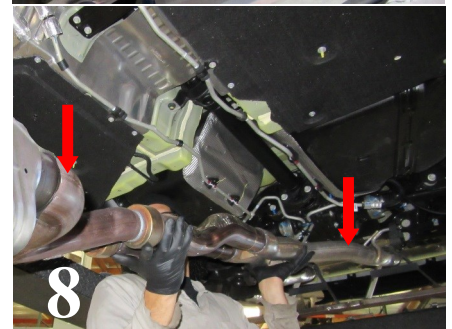
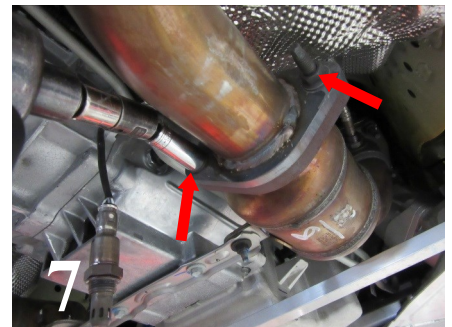
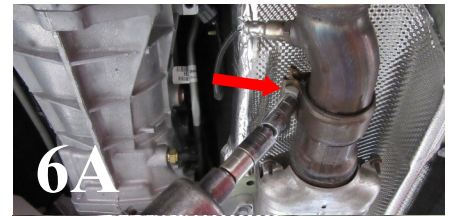
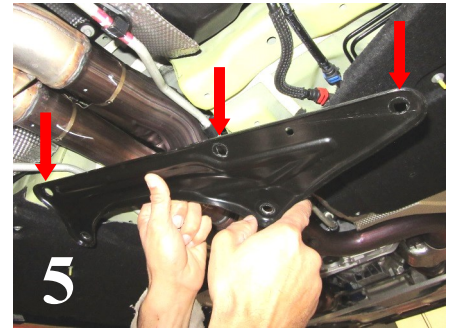

**Caution!!!** *Never work on a hot exhaust system. Serious injury in the form of burns can result if the vehicle has been in use and the exhaust system is hot, allow vehicle to cool for at least 1 hour. Always wear eye protection when working under any vehicle.*

**Note:** *It is our recommendation that you use a hoist or hydraulic lift to facilitate the installation of your new Borla Performance Exhaust System.*

**Taking all under car safety precautions, lift the vehicle using a hoist or hydraulic lift. Once this has been done, you may begin the removal of your old exhaust system from your vehicle.**

**Note:** *Before removing the original exhaust system from your vehicle, please compare the parts you have received with the bill of materials provided on the previous page to assure that you have all the parts necessary for the installation of your new Borla Performance Exhaust System.*

**Note:** *With a used vehicle, we suggest a penetrating spray lubricant to be applied liberally to all exhaust fasteners and allowing a significant period of time for the chemical to lubricate the threads before attempting to disassemble.*

## (PN-60611 ONLY)

### Original Exhaust System Removal

1. Remove Rear Mufflers (REFER TO BORLA REAR SECTION INSTALLATION GUIDE). Disconnect left and right side O2 sensors from mid pipe.
2. Remove factory cross brace and keep hardware for installation later. Support the factory mid pipe with a muffler stand. (See Fig. 9)
3. **Disconnect wire harnesses from AFM valve (if equipped) and secure to vehicle sealing ends with electrical tape (not included in kit).**
4. LEFT SIDE: Loosen clamp in front of catalytic converter. Cut tab and remove clamp from pipe. (See Figs. 10A & 10B)
5. RIGHT SIDE: Loosen (2) nuts and keep hardware for reinstallation later. (See Fig. 11)
6. Remove hangers from rubber isolators and carefully remove factory mid pipe from vehicle. (See Fig. 12)

**WARNING:** *Use extreme caution during installation. Torque all fasteners according to manufacturer's torque values and tightening sequence. **DO NOT** use air impact tools to tighten fasteners on Borla Performance Exhaust Systems. Use of such tools may result in bent flanges or gasket contact areas leading to exhaust leaks.*

**NOTE:** *When you first start your vehicle after the installation of your new Borla Performance Exhaust System, there may be some smoke and fumes coming from the system. This is a protective oil based coating used in the manufacturing of mandrel bent performance exhaust tubing. This is not a problem and will disappear within a very short period of time after the exhaust has reached normal operating temperatures.*

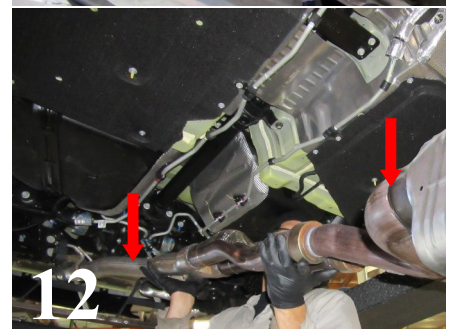
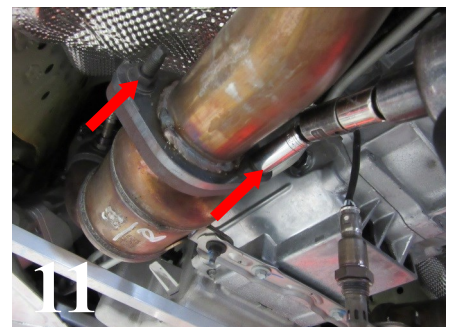
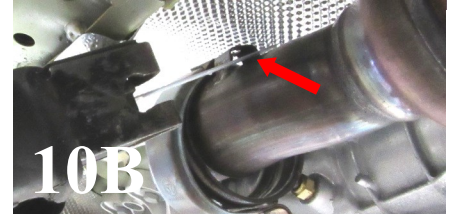
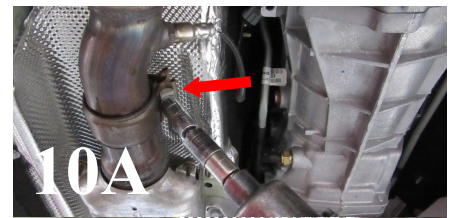
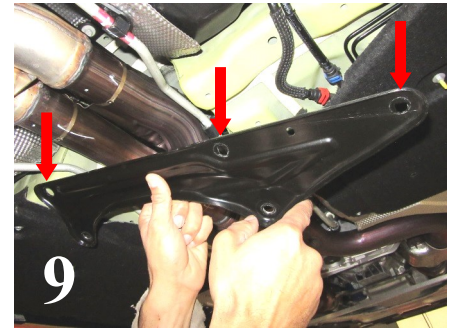



## Borla Performance Exhaust Installation

1. **60606, 60607:** Place a clamp on each expanded end of the **Front Pipe Assembly** and insert to the cut outlet pipes. Proceed to STEP 4.
2. **60609, 60610:** Place a clamp on the expanded end of the **L/S Front Pipe Assembly** and insert in factory left side front outlet. Attach **R/S Front Pipe** to right side front flange using factory hardware. Proceed to STEP 4.(See Figs. 13A& 13B)
3. **60611:** Place a clamp on the expanded end of the **R/S Front Pipe Assembly** and insert in factory right side front outlet. Attach **L/S Front Pipe** to left side front flange using factory hardware. Proceed to STEP 4.
4. Place one clamp on each expanded end of two **Mid Pipes (or Touring Resonator Option PN-60608)** and insert the ends into each outlet of installed **Front Pipe** outlet. (See Fig. 14)
5. Place a clamp on each expanded end of the **X-Pipe** and insert ends to the installed **Mid Pipe (or Touring Resonator Option PN-60608)** outlet. Place a clamp over each outlet of the **Mid Pipe**. (See Fig. 15)
6. *Refer to installation instructions for your Borla Rear Section Mufflers.*
7. *Its best to start tightening hardware from the front of the vehicle then moving to the rear.* Once position has been determined to be correct, tighten the clamp bolts, 32-35 ft. lbs. and flange hardware 15-17 ft. lbs. (See Fig. 16)
8. Before starting your vehicle, make sure to check all wires, hoses, brake lines, body parts and tires for safe clearance from the exhaust system.
9. Start vehicle and check for any leaks. If any leaks are found, determine cause (such as loose or incorrectly positioned clamp) and repair as necessary.

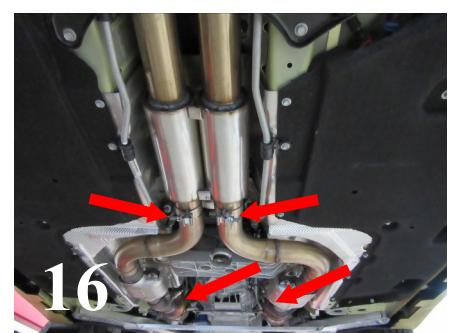
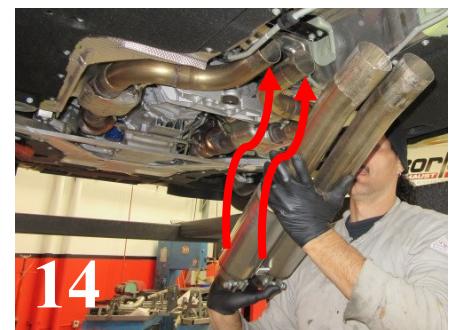
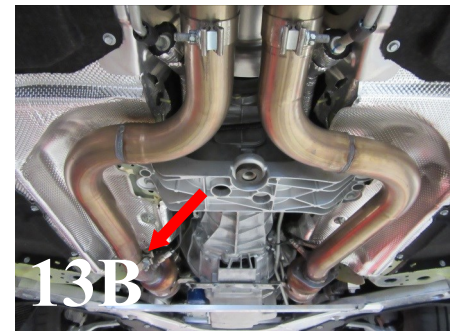
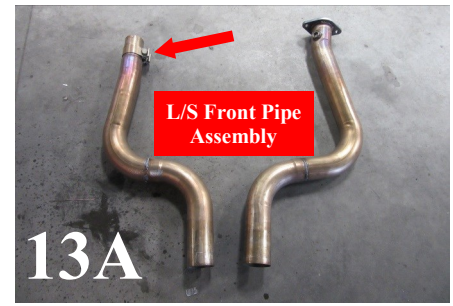

**WARNING:** Use extreme caution during installation. Torque all fasteners according to manufacturer's torque values and tightening sequence. **DO NOT** use air impact tools to tighten fasteners on Borla Performance Exhaust Systems. Use of such tools may result in bent flanges or gasket contact areas leading to exhaust leaks.

**NOTE:** When you first start your vehicle after the installation of your new Borla Performance Exhaust System, there may be some smoke and fumes coming from the system. This is a protective oil based coating used in the manufacturing of mandrel bent performance exhaust tubing. This is not a problem and will disappear within a very short period of time after the exhaust has reached normal operating temperatures.